

C-18-0289

CONTRACT DOCUMENTS

**CITY OF LINCOLN, NEBRASKA,
LANCASTER COUNTY,
CITY OF LINCOLN - LANCASTER COUNTY
PUBLIC BUILDING COMMISSION**

**Annual Supply
Office Seating
Bid No. 18-117**

**Office Interiors & Design, Inc.
121 Cherry Hill Blvd.
Lincoln, NE 68510
(402) 484-7500**

**CITY OF LINCOLN-LANCASTER COUNTY, NEBRASKA and
LINCOLN-LANCASTER COUNTY PUBLIC BUILDING COMMISSION
CONTRACT TERMS**

THIS CONTRACT, made and entered into by and between **Office Interiors & Design, Inc., 121 Cherry Hill Blvd., Lincoln, NE 68510**, hereinafter called "Contractor", and the City of Lincoln, Nebraska, a municipal corporation, and the County of Lancaster, Nebraska, a political subdivision of the State of Nebraska, and the Lincoln-Lancaster County Public Building Commission hereinafter called the "Owners".

WHEREAS, the Owners have caused to be prepared, in accordance with law, Specifications, Plans, and other Contract Documents for the Work herein described, and has approved and adopted said documents and has caused to be published an advertisement for and in connection with said Work, to-wit:

Office Seating, Bid No. 18-117

and,

WHEREAS, the Contractor, in response to such advertisement, has submitted to the Owners, in the manner and at the time specified, a sealed Proposal/Supplier Response in accordance with the terms of said advertisement; and,

WHEREAS, the Owners, in the manner prescribed by law has publicly opened, read aloud, examined, and canvassed the Proposals/Supplier Responses submitted in response to such advertisement, and as a result of such canvass has determined and declared the Contractor to be the lowest responsible bidder for the said Work for the sum or sums named in the Contractor's Proposal/Supplier Responses, a copy thereof being attached to and made a part of this Contract;

NOW, THEREFORE, in consideration of the sums to be paid to the Contractor and the mutual covenants herein contained, the Contractor and the Owners have agreed and hereby agree as follows:

1. The Contractor agrees to (a) furnish all tools, equipment, supplies, superintendence, transportation, and other accessories, services, and facilities; (b) furnish all materials, supplies, and equipment specified to be incorporated into and form a permanent part of the complete work; (c) provide and perform all necessary labor in a substantial and workmanlike manner and in accordance with the provisions of the Contract Documents; and (d) execute and complete all Work included in and covered by the Owners' award of this Contract to the Contractor, such award being based on the acceptance by the Owner of the Contractor's Proposal, or part thereof, as follows:

Agreement to Line Item Number 1, 2, Line 3 Alternate and 5 of Contractor's Proposal

2. The Owners agree to pay to the Contractor for the performance of the Work embraced in this Contract, the Contractor agrees to accept as full compensation therefore, the following sums and prices for all Work covered by and included in the Contract award and designated above, payment thereof to be made in the manner provided by the Owners:

"Contracted Vendors" shall mean all vendors who contract or who have contracted with the Owners pursuant to Bid No. 18-117, Annual Supply – Office Seating.

"Contracts" shall mean the collective contracts entered into between the Owners and the Contracted Vendors pursuant to Bid No. 18-117, Annual Supply – Office Seating.

The Owners will pay for products/service, according to the Line Item pricing as listed in Contractors Proposal/Supplier Response, a copy thereof being attached to and made a part of this Contract. The Owners shall order on an as-needed basis for the duration of the contract. The cost of products or services for City Departments shall not exceed \$45,000.00 for Contracts during the contract term without approval. The cost of products or services for County Agencies shall not exceed \$30,000.00 for Contracts during the contract term without approval by the Board of Commissioners. The cost of products or services for the Public Building Commission shall not exceed \$5,000.00 for Contracts during the contract term without approval by the Board of the Public Building Commission.

3. Equal Employment Opportunity. In connection with the carrying out of this project, the contractor shall not discriminate against any employee or applicant for employment because of race, color, religion, sex, national origin, ancestry, disability, age or marital status. The Contractor will take affirmative action to ensure that applicants are employed, and that employees are treated during employment, without regard to their race, color, religion, sex, national origin, ancestry, disability, age or marital status. Such action shall include, but not be limited to, the following: employment, upgrading, demotion or transfer; recruitment or recruitment advertising; layoff or termination; rates of pay or other compensation; and selection for training, including apprenticeship.
4. E-Verify. In accordance with Neb. Rev. Stat. 4-108 through 4-114, the contractor agrees to register with and use a federal immigration verification system, to determine the work eligibility status of new employees performing services within the state of Nebraska. A federal immigration verification system means the electronic verification of the work authorization program of the Illegal Immigration Reform and Immigrant Responsibility Act of 1996, 8 U.S.C. 1324 a, otherwise known as the E-Verify Program, or an equivalent federal program designated by the United States Department of Homeland Security or other federal agency authorized to verify the work eligibility status of a newly hired employee pursuant to the Immigration Reform and Control Act of 1986. The Contractor shall not discriminate against any employee or applicant for employment to be employed in the performance of this section pursuant to the requirements of state law and 8 U.S.C.A 1324b. The contractor shall require any subcontractor to comply with the provisions of this section.
5. Termination. This Contract may be terminated by the following:
 - 5.1) Termination for Convenience. Either party may terminate this Contract upon thirty (30) days written notice to the other party for any reason without penalty.
 - 5.2) Termination for Cause. The Owners may terminate the Contract for cause if the Contractor:
 - 5.2.1) Refuses or fails to supply the proper labor, materials and equipment necessary to provide services and/or commodities.
 - 5.2.2) Disregards Federal, State or local laws, ordinances, regulations, resolutions or orders.
 - 5.2.3) Otherwise commits a substantial breach or default of any provision of the Contract Document. In the event of a substantial breach or default the Owners will provide the Contractor written notice of said breach or default and allow the Contractor ten (10) days from the date of the written notice to cure such breach or default. If said breach or default is not cured within ten (10) days from the date of notice, then the contract shall terminate.
6. Independent Contractor. It is the express intent of the parties that this contract shall not create an employer-employee relationship. Employees of the Contractor shall not be deemed to be employees of the Owners and employees of the Owners shall not be deemed to be employees of the Contractor. The Contractor and the Owners shall be responsible to their respective employees for all salary and benefits. Neither the Contractor's employees nor the Owners' employees shall be entitled to any salary, wages, or benefits from the other party, including but not limited to overtime, vacation, retirement benefits, workers' compensation, sick leave or injury leave. Contractor shall also be responsible for maintaining workers' compensation insurance, unemployment insurance for its employees, and for payment of all federal, state, local and any other payroll taxes with respect to its employees' compensation.

7. Owner Inclusion. It is understood and agreed by all parties that "Owner/s" shall include the City of Lincoln, Lancaster County, Nebraska and Lincoln-Lancaster County Public Building Commission. Whenever in the Contract documents, including the instructions to bidders, specifications, insurance requirements, bonds, and terms and conditions or any other documents which are a part of the Contract, a singular entity is referenced (i.e., "the City" or "the County" or "Building Commission") it shall mean the "Owners" encompassing the City of Lincoln, Lancaster County and Lincoln-Lancaster County Building Commission. Notwithstanding the foregoing, the duties and obligations of the City, the County, and the Building Commission pursuant to the Contract shall be treated as divisible and severable duties and obligations, and default by any one of the City, the County, or the Building Commission shall not be attributed to any other of the Owners, but shall remain the sole obligation of the defaulting entity.
8. Audit Provision: The Contractor shall be subject to an audit and shall, upon request, make available to the Public Building Commission or a contract auditor hired by the Public Service Commission, copies of all financial and performance related records and materials related to this Agreement, as allowed by law.
9. Period of Performance. This Contract shall be effective upon execution by all parties. The term of the Contract shall be a one (1) year term with the option to renew for four (4) additional one (1) year terms.
10. The Contract Documents comprise the Contract, and consist of the following:
1. Contract Terms
 2. Accepted Proposal/Response
 3. Insurance Certificate with Endorsements
 4. Sample Order Form
 5. Special Provisions
 6. Specifications
 7. Instructions to Bidders
 8. Insurance Requirements
 9. Sales Tax Exemption Form 13
- (Note: This form cannot be used for the WATER Division of the City of Lincoln. The WATER Division is taxable per Reg. 066.14A or applicable laws.)

The herein above mentioned Contract Documents form this Contract and are a part of the Contract as if hereto attached. Said documents which are not attached to this document may be viewed at: lincoln.ne.gov - Keyword: Bid - Awarded or Closed bids.

The Contractor and the Owners hereby agree that all the terms and conditions of this Contract shall be binding upon themselves, and their heirs, administrators, executors, legal and personal representatives, successors, and assigns.

IN WITNESS WHEREOF, the Contractor and the Owners do hereby execute this contract upon completion of signatures on:

Vendor Signature Page
 City of Lincoln Signature Page
 Lancaster County Signature Page
 City of Lincoln-Lancaster County Public Building Commission Signature Page

Vendor Signature Page

**CONTRACT
Annual Supply
Office Seating
Bid No. 18-117
City of Lincoln, Lancaster County and
City of Lincoln-Lancaster County Public Building Commission
Office Interiors & Design, Inc.**

EXECUTION BY CONTRACTOR

IF A CORPORATION:

Attest:

Secretary Seal

OFFICE INTERIORS & DESIGN, INC.
Name of Corporation

121 CHERRY HILL BLD.
Address

By: SARA M. DAWES
Duly Authorized Official

Vice President
Legal Title of Official

IF OTHER TYPE OF ORGANIZATION:

Name of Organization

Type of Organization

Address

By: _____
Member

By: _____
Member

IF AN INDIVIDUAL:

Name

Address

Signature

City of Lincoln Signature Page

**CONTRACT
Annual Supply
Office Seating
Bid No. 18-117
City of Lincoln, Lancaster County and
City of Lincoln-Lancaster County Public Building Commission
Office Interiors & Design, Inc.**

EXECUTION BY THE CITY OF LINCOLN, NEBRASKA

ATTEST:

City Clerk

CITY OF LINCOLN, NEBRASKA

Chris Beutler, Mayor

Approved by Executive Order No. _____

dated _____

Lancaster County Signature Page

**CONTRACT
Annual Supply
Office Seating
Bid No. 18-117
City of Lincoln, Lancaster County and
City of Lincoln-Lancaster County Public Building Commission
Office Interiors & Design, Inc.**

EXECUTION BY LANCASTER COUNTY, NEBRASKA

Contract Approved as to Form:

The Board of County Commissioners of
Lancaster, Nebraska

Deputy Lancaster County Attorney

dated _____

**Lincoln-Lancaster County Public Building Commission
Signature Page**

**CONTRACT
Annual Supply
Office Seating
Bid No. 18-117
City of Lincoln, Lancaster County and
City of Lincoln-Lancaster County Public Building Commission
Office Interiors & Design, Inc.**

EXECUTION BY LINCOLN-LANCASTER COUNTY PUBLIC BUILDING COMMISSION

ATTEST:

Public Building Commission Attorney

Chairperson, Public Building Commission

dated _____

City of Lincoln/Lancaster County (Lincoln Purchasing) Supplier Response

Bid Information		Contact Information		Ship to Information
Bid Creator	Sharon Mulder Asst Purchasing Agent	Address	Purchasing 440 S. 8th St. Lincoln, NE 68508	Address
Email	smulder@lincoln.ne.gov	Contact	Sharon Mulder Asst Purchasing Agent	Contact
Phone	(402) 441-7428 x			
Fax	(402) 441-6513 x			
Bid Number	18-117	Department		Department
Title	Office Seating	Building		Building
Bid Type	Bid		Suite 200	Floor/Room
Issue Date	5/2/2018 03:00 PM (CT)	Floor/Room		Telephone
Close Date	5/16/2018 12:00:00 PM (CT)	Telephone	(402) 441-7428 x	Fax
		Fax	(402) 441-6513 x	Email
		Email	smulder@lincoln.ne.gov	

Supplier Information

Company OFFICE INTERIORS & DESIGN, INC.
 Address 121 CHERRY HILL BLVD.
 LINCOLN, NE 68510
 Contact Nancy Kraft
 Department
 Building
 Floor/Room
 Telephone (402) 484-7500
 Fax (402) 484-7575
 Email NANCY.KRAFT@OIDINC.COM
 Submitted 5/15/2018 02:56:28 PM (CT)
 Total \$2,063.95

By submitting your response, you certify that you are authorized to represent and bind your company.

Signature Nancy Kraft

Email nancy.kraft@oidinc.com

Supplier Notes

All seating in this bid the labor to receive assemble and deliver to end user \$35 each.

Bid Notes

Bid Activities

Bid Messages

Bid Attributes

Please review the following and respond where necessary

#	Name	Note	Response
1	Instructions to Bidders	I acknowledge reading and understanding the Instructions to Bidders.	Yes
2	Specifications	I acknowledge reading and understanding the specifications.	Yes
3	Delivery	State number of delivery days ARO. FOB to the City/County at the location specified with all transportation charges paid.	15-30 days
4	Insurance Requirements and Endorsements	<p>Vendor agrees to provide insurance coverage for each checked box on the Insurance Clause document in the Bid Attachments including the submission of the Certificate of ACORD and the applicable endorsements.</p> <p>Insurance Certificate and required Endorsements are required at time of contract execution by the vendor.</p> <p>Vendors are strongly encouraged to send the insurance requirements and endorsement information to their insurance agent prior to bid close in order to expedite the contract execution process.</p>	Yes
5	Sample Contract	I acknowledge reading and understanding the sample contract.	Yes
6	Purchase Order, Contract and Delivery Contact	<p>The City/County Purchasing Department issues Purchase Orders and Contracts via email to a designated contact person of the awarded Vendor. This designee will be the primary contact with the department through the delivery of the product/services.</p> <p>Please list the name, email address and phone number of the person who will be the contact person for the PO to be awarded.</p>	Nancy Kraft nancy.kraft@oidinc.com 402-484-7500
7	Contact	Name of person submitting this bid:	Nancy Kraft
8	Special Provision Term Contract Provisions	I acknowledge reading and understanding the Special Provision Term Contract Provisions.	Yes
9	Renewal is an Option	Contract Extension Renewal is an option.	Yes
10	Term Clause of Contract	<p>I acknowledge that the term of the contract is for a one (1) year term with the option for four (4) additional one (1) year renewals from the date of the executed contract. (a) Are your bid prices firm for the first one (1) year contract period. YES or NO _____</p> <p>(b) Are your bid prices subject to escalation/de-escalation YES or NO _____</p> <p>(c) If (b), state period for which prices will remain firm: through _____</p>	A. yes B. yes after one year C. one year
11	Contractor Must Provide References in Bidders Response Section	<p>Contractor must provide (2) two references for where the chairs being offered are currently in use. Each reference must include the following:</p> <p>Owner: Street Address: City: State: Zip: Name Owners Representative: Phone: Project Name and/or Number: Contract Amount: Completion Date:</p>	YES

- | | | | |
|----|-----------------------------------|---|-----|
| 12 | Debarred | Has your company ever been debarred or suspended for doing business with the City of Lincoln/Lancaster County/PBC of Nebraska | no |
| 13 | U.S. Citizenship Attestation | <p>Is your company legally considered an Individual or Sole Proprietor: YES or NO</p> <p>As a Vendor who is legally considered an Individual or a Sole Proprietor I hereby understand and agree to comply with the requirements of the United States Citizenship Attestation Form, available at:
 http://www.sos.ne.gov/business/notary/citizenforminfo.html</p> <p>All awarded Vendors who are legally considered an Individual or a Sole Proprietor must complete the form and submit it with contract documents at time of execution.</p> <p>If a Vendor indicates on such attestation form that he or she is a qualified alien, the Vendor agrees to provide the US Citizenship and Immigration Services documentation required to verify the Vendor's lawful presence in the United States using the Systematic Alien Verification for Entitlements (SAVE) Program.</p> <p>Vendor further understands and agrees that lawful presence in the United States is required and the Vendor may be disqualified or the Contract terminated if such lawful presence cannot be verified as required by Neb. Rev. Stat. 4-108.</p> | no |
| 14 | Bid Award | <p>a) I acknowledge and understand that the City, County and/or Public Building Commission reserves the right to award bids item-by-item, with or without alternates/options, by groups, or "lump sum" such as shall best serve the requirements and interests of the City, County and/or Public Building Commission. Do you agree and understand? Yes/No_____</p> <p>b) Is your pricing based on all-or-nothing basis, please indicate is so. Yes/No_____</p> | yes |
| 15 | Recycling of Corrugated Cardboard | I acknowledge that I must comply with the City of Lincoln recycling regulations which includes a ban of all corrugated cardboard from the City Landfill effective April 1, 2018. Vendors are encouraged to utilize recycling sites located throughout the city of Lincoln to dispose of corrugated cardboard. | Yes |
| 16 | Electronic Signature | Please check here for your electronic signature. | Yes |

Line Items

#	Qty	UOM	Description	Response
1	1	EA	Fully Functional Office Seating Chairs that fall into the Owners price range of \$300.00 to \$400.00	\$394.00

Item Notes: A minimum of two (2) chairs will be selected for this category with the Owner's determining if additional chairs will be added. If you wish to bid more chairs, you can click in the bid line; "add alternate" to add additional chairs.

Supplier Notes:

Item Attributes: Please review the following and respond where necessary

#	Name	Note	Response
1	Manufacturer and Model	Please provide the Manufacturer and Model bidding.	Teknion Savera NSAMH1QP-1EF
2	Warranty	I acknowledge that I have attached the warranty information related to each chair bidding to the Vendor's Response Attachment Section of the e-bid.	Yes
3	Manufacturer's Price List	I acknowledge that I have attached the Manufacturer's Price List for our basis of pricing to the Vendor's Response Attachment Section of the e-bid.	Yes
4	Discount Schedule	I acknowledge that I have attached the Discount Schedule per Specifications, Section 2, 2.2.4 and 2.2.4.1 to the Vendor's Response Attachment Section of the e-bid.	Yes

Alt 1	1	EA	Alt Spec: SitOnIt Torsa task chair	362.02
-------	---	----	------------------------------------	--------

Alt Manufacturer: SitOnIt Alt Manufacturer #: 6023Y/E3A134FG1C25B14MC5FC11Z3KD

Item Notes: A minimum of two (2) chairs will be selected for this category with the Owner's determining if additional chairs will be added. If you wish to bid more chairs, you can click in the bid line; "add alternate" to add additional chairs.

Supplier Notes:

Item Attributes: Please review the following and respond where necessary

#	Name	Note	Response
1	Manufacturer and Model	Please provide the Manufacturer and Model bidding.	SitOnIt Torsa 6023Y/E3A134FGC25B14MC5FC11Z3KD
2	Warranty	I acknowledge that I have attached the warranty information related to each chair bidding to the Vendor's Response Attachment Section of the e-bid.	Yes
3	Manufacturer's Price List	I acknowledge that I have attached the Manufacturer's Price List for our basis of pricing to the Vendor's Response Attachment Section of the e-bid.	Yes
4	Discount Schedule	I acknowledge that I have attached the Discount Schedule per Specifications, Section 2, 2.2.4 and 2.2.4.1 to the Vendor's Response Attachment Section of the e-bid.	Yes

2 1 EA Functional Office Seating Chairs that fall into the Owners price range of \$400.00 to \$500.00 \$549.00

Item Notes: A minimum of two (2) chairs will be selected for this category with the Owner's determining if additional chairs will be added. If you wish to bid more chairs, you can click in the bid line; "add alternate" to add additional chairs.

Supplier Notes:

Item Attributes: Please review the following and respond where necessary

#	Name	Note	Response
1	Manufacturer and Model	Please provide the Manufacturer and Model bidding.	VIA Proform 172-62c-1045-18ab-18bb-16hp-GRA
2	Warranty	I acknowledge that I have attached the warranty information related to each chair bidding to the Vendor's Response Attachment Section of the e-bid.	Yes
3	Manufacturer's Price List	I acknowledge that I have attached the Manufacturer's Price List for our basis of pricing to the Vendor's Response Attachment Section of the e-bid.	Yes
4	Discount Schedule	I acknowledge that I have attached the Discount Schedule per Specifications, Section 2, 2.2.4 and 2.2.4.1 to the Vendor's Response Attachment Section of the e-bid.	Yes

Alt 1 1 EA Alt Spec: VIA Swopper Chair 564.00

Alt Manufacturer: VIA Swopper Alt Manufacturer #: 1-SWUS-A-GR2

Item Notes: A minimum of two (2) chairs will be selected for this category with the Owner's determining if additional chairs will be added. If you wish to bid more chairs, you can click in the bid line; "add alternate" to add additional chairs.

Supplier Notes:

Item Attributes: Please review the following and respond where necessary

#	Name	Note	Response
1	Manufacturer and Model	Please provide the Manufacturer and Model bidding.	VIA Swopper 1-SWUS-A-GR2
2	Warranty	I acknowledge that I have attached the warranty information related to each chair bidding to the Vendor's Response Attachment Section of the e-bid.	Yes
3	Manufacturer's Price List	I acknowledge that I have attached the Manufacturer's Price List for our basis of pricing to the Vendor's Response Attachment Section of the e-bid.	Yes
4	Discount Schedule	I acknowledge that I have attached the Discount Schedule per Specifications, Section 2, 2.2.4 and 2.2.4.1 to the Vendor's Response Attachment Section of the e-bid.	Yes

3 1 EA Functional Office Seating Chairs that fall into the Owners price range of \$500.00 to \$600.00 \$569.00

Item Notes: A minimum of two (2) chairs will be selected for this category with the Owner's determining if additional chairs will be added. If you wish to bid more chairs, you can click in the bid line; "add alternate" to add additional chairs.

Supplier Notes:

Item Attributes: Please review the following and respond where necessary

#	Name	Note	Response
1	Manufacturer and Model	Please provide the Manufacturer and Model bidding.	Allseating You Highback 84112-4D-BK-3EB-KD-F-OC DAN
2	Warranty	I acknowledge that I have attached the warranty information related to each chair bidding to the Vendor's Response Attachment Section of the e-bid.	Yes
3	Manufacturer's Price List	I acknowledge that I have attached the Manufacturer's Price List for our basis of pricing to the Vendor's Response Attachment Section of the e-bid.	Yes
4	Discount Schedule	I acknowledge that I have attached the Discount Schedule per Specifications, Section 2, 2.2.4 and 2.2.4.1 to the Vendor's Response Attachment Section of the e-bid.	Yes

Alt 1 1 EA Alt Spec: SitOnIt Prava Highback fully upholstered task chair 6423YE3A105VG2C16B8KD 539.85
TCPN pricing

Alt Manufacturer: SitOnIt Prava Highback task chair Alt Manufacturer #: 6423YE3A105VG2C16B8KD

Item Notes: A minimum of two (2) chairs will be selected for this category with the Owner's determining if additional chairs will be added. If you wish to bid more chairs, you can click in the bid line; "add alternate" to add additional chairs.

Supplier Notes:

Item Attributes: Please review the following and respond where necessary

#	Name	Note	Response
1	Manufacturer and Model	Please provide the Manufacturer and Model bidding.	SITONIT PRAVA 6423YE3A105VG2C16B8KD
2	Warranty	I acknowledge that I have attached the warranty information related to each chair bidding to the Vendor's Response Attachment Section of the e-bid.	Yes
3	Manufacturer's Price List	I acknowledge that I have attached the Manufacturer's Price List for our basis of pricing to the Vendor's Response Attachment Section of the e-bid.	Yes
4	Discount Schedule	I acknowledge that I have attached the Discount Schedule per Specifications, Section 2, 2.2.4 and 2.2.4.1 to the Vendor's Response Attachment Section of the e-bid.	Yes

4 1 EA Functional Office Seating Chairs that fall into the Owners price range of \$600.00 to \$750.00 No Bid

Item Notes: A minimum of two (2) chairs will be selected for this category with the Owner's determining if additional chairs will be added. If you wish to bid more chairs, you can click in the bid line; "add alternate" to add additional chairs.

Supplier Notes:

Item Attributes: Please review the following and respond where necessary

#	Name	Note	Response
1	Manufacturer and Model	Please provide the Manufacturer and Model bidding.	
2	Warranty	I acknowledge that I have attached the warranty information related to each chair bidding to the Vendor's Response Attachment Section of the e-bid.	
3	Manufacturer's Price List	I acknowledge that I have attached the Manufacturer's Price List for our basis of pricing to the Vendor's Response Attachment Section of the e-bid.	
4	Discount Schedule	I acknowledge that I have attached the Discount Schedule per Specifications, Section 2, 2.2.4 and 2.2.4.1 to the Vendor's Response Attachment Section of the e-bid.	

5 1 EA Functional Bariatric Office Seating Chairs \$551.95

Item Notes: A minimum of two (2) chairs will be selected for this category with the Owner's determining if additional chairs will be added. If you wish to bid more chairs, you can click in the bid line; "add alternate" to add additional chairs.

Supplier Notes:

Item Attributes: Please review the following and respond where necessary

#	Name	Note	Response
1	Manufacturer and Model	Please provide the Manufacturer and Model bidding.	Teknion Savera XL NSAXF1GPF0102M145S1E TCPN Pricing
2	Warranty	I acknowledge that I have attached the warranty information related to each chair bidding to the Vendor's Response Attachment Section of the e-bid.	Yes
3	Manufacturer's Price List	I acknowledge that I have attached the Manufacturer's Price List for our basis of pricing to the Vendor's Response Attachment Section of the e-bid.	Yes
4	Discount Schedule	I acknowledge that I have attached the Discount Schedule per Specifications, Section 2, 2.2.4 and 2.2.4.1 to the Vendor's Response Attachment Section of the e-bid.	Yes

Alt 1 1 EA Alt Spec: VIA 4U BARIATRIC 488.00

Alt Manufacturer: VIA Alt Manufacturer #: 781-68C-B-38A1-17AB-18BB-16HP-O1U-GRA

Item Notes: A minimum of two (2) chairs will be selected for this category with the Owner's determining if additional chairs will be added. If you wish to bid more chairs, you can click in the bid line; "add alternate" to add additional chairs.

Supplier Notes:

Item Attributes: Please review the following and respond where necessary

#	Name	Note	Response
1	Manufacturer and Model	Please provide the Manufacturer and Model bidding.	VIA 4U BARI 781-68C-B38A1-17AB-18BB-16HP-O1U-GRA
2	Warranty	I acknowledge that I have attached the warranty information related to each chair bidding to the Vendor's Response Attachment Section of the e-bid.	Yes
3	Manufacturer's Price List	I acknowledge that I have attached the Manufacturer's Price List for our basis of pricing to the Vendor's Response Attachment Section of the e-bid.	Yes
4	Discount Schedule	I acknowledge that I have attached the Discount Schedule per Specifications, Section 2, 2.2.4 and 2.2.4.1 to the Vendor's Response Attachment Section of the e-bid.	Yes

Alt 2 1 EA Alt Spec: RFM EVOLVE BT BARI CHAIR TO 400LBS. 447.00

Alt Manufacturer: RFM Seating Alt Manufacturer #: BT-16-2024-12A-GRD2

Item Notes: A minimum of two (2) chairs will be selected for this category with the Owner's determining if additional chairs will be added. If you wish to bid more chairs, you can click in the bid line; "add alternate" to add additional chairs.

Supplier Notes:

Item Attributes: Please review the following and respond where necessary

#	Name	Note	Response
1	Manufacturer and Model	Please provide the Manufacturer and Model bidding.	RFM Seating Evolve BT BT-16-2024-12A-GRD2
2	Warranty	I acknowledge that I have attached the warranty information related to each chair bidding to the Vendor's Response Attachment Section of the e-bid.	Yes
3	Manufacturer's Price List	I acknowledge that I have attached the Manufacturer's Price List for our basis of pricing to the Vendor's Response Attachment Section of the e-bid.	Yes
4	Discount Schedule	I acknowledge that I have attached the Discount Schedule per Specifications, Section 2, 2.2.4 and 2.2.4.1 to the Vendor's Response Attachment Section of the e-bid.	Yes

Response Total: \$2,063.95

CERTIFICATE OF LIABILITY INSURANCE

THIS CERTIFICATE IS ISSUED AS A MATTER OF INFORMATION ONLY AND CONFERS NO RIGHTS UPON THE CERTIFICATE HOLDER. THIS CERTIFICATE DOES NOT AFFIRMATIVELY OR NEGATIVELY AMEND, EXTEND OR ALTER THE COVERAGE AFFORDED BY THE POLICIES BELOW. THIS CERTIFICATE OF INSURANCE DOES NOT CONSTITUTE A CONTRACT BETWEEN THE ISSUING INSURER(S), AUTHORIZED REPRESENTATIVE OR PRODUCER, AND THE CERTIFICATE HOLDER.

IMPORTANT: If the certificate holder is an ADDITIONAL INSURED, the policy(ies) must be endorsed. If SUBROGATION IS WAIVED, subject to the terms and conditions of the policy, certain policies may require an endorsement. A statement on this certificate does not confer rights to the certificate holder in lieu of such endorsement(s).

PRODUCER INSPRO Insurance P.O. Box 6847 Lincoln, NE 68506 402 483-4500	CONTACT NAME: Sunshine Roberts PHONE (A/C, No, Ext): 402-483-4500 E-MAIL ADDRESS: sroberts@insproins.com	FAX (A/C, No): 402-483-7977
	INSURER(S) AFFORDING COVERAGE	
INSURED Office Interiors and Design, Inc. 121 Cherry Hill Blvd. Lincoln, NE 68510	INSURER A: QBE Insurance Corporation	NAIC # 39217
	INSURER B: Guarantee Insurance Company	NAIC # 11398
	INSURER C:	
	INSURER D:	
	INSURER E:	
	INSURER F:	

COVERAGES **CERTIFICATE NUMBER:** **REVISION NUMBER:**

THIS IS TO CERTIFY THAT THE POLICIES OF INSURANCE LISTED BELOW HAVE BEEN ISSUED TO THE INSURED NAMED ABOVE FOR THE POLICY PERIOD INDICATED. NOTWITHSTANDING ANY REQUIREMENT, TERM OR CONDITION OF ANY CONTRACT OR OTHER DOCUMENT WITH RESPECT TO WHICH THIS CERTIFICATE MAY BE ISSUED OR MAY PERTAIN, THE INSURANCE AFFORDED BY THE POLICIES DESCRIBED HEREIN IS SUBJECT TO ALL THE TERMS, EXCLUSIONS AND CONDITIONS OF SUCH POLICIES. LIMITS SHOWN MAY HAVE BEEN REDUCED BY PAID CLAIMS.

INSR LTR	TYPE OF INSURANCE	ADDL INSR	SUBR WVD	POLICY NUMBER	POLICY EFF (MM/DD/YYYY)	POLICY EXP (MM/DD/YYYY)	LIMITS
A	<input checked="" type="checkbox"/> COMMERCIAL GENERAL LIABILITY <input type="checkbox"/> CLAIMS-MADE <input checked="" type="checkbox"/> OCCUR GEN'L AGGREGATE LIMIT APPLIES PER: <input type="checkbox"/> POLICY <input type="checkbox"/> PRO-JECT <input type="checkbox"/> LOC OTHER:	X	X	CFB0688134	06/23/2017	06/23/2018	EACH OCCURRENCE \$1,000,000 DAMAGE TO RENTED PREMISES (Ea occurrence) \$100,000 MED EXP (Any one person) \$5,000 PERSONAL & ADV INJURY \$1,000,000 GENERAL AGGREGATE \$2,000,000 PRODUCTS - COMP/OP AGG \$2,000,000 \$
A	<input type="checkbox"/> ANY AUTO <input type="checkbox"/> ALL OWNED AUTOS <input checked="" type="checkbox"/> SCHEDULED AUTOS <input checked="" type="checkbox"/> HIRED AUTOS <input checked="" type="checkbox"/> NON-OWNED AUTOS	X		CBA0688131	06/23/2017	06/23/2018	COMBINED SINGLE LIMIT (Ea accident) \$1,000,000 BODILY INJURY (Per person) \$ BODILY INJURY (Per accident) \$ PROPERTY DAMAGE (Per accident) \$ \$
A	<input checked="" type="checkbox"/> UMBRELLA LIAB <input checked="" type="checkbox"/> OCCUR <input type="checkbox"/> EXCESS LIAB <input type="checkbox"/> CLAIMS-MADE DED RETENTION \$	X		CCU0688132	06/23/2017	06/23/2018	EACH OCCURRENCE \$2,000,000 AGGREGATE \$2,000,000 \$
B	WORKERS COMPENSATION AND EMPLOYERS' LIABILITY ANY PROPRIETOR/PARTNER/EXECUTIVE OFFICER/MEMBER EXCLUDED? (Mandatory in NH) If yes, describe under DESCRIPTION OF OPERATIONS below		Y/N <input checked="" type="checkbox"/> Y <input type="checkbox"/> N/A	WCP101275903GIC	06/23/2017	06/23/2018	<input checked="" type="checkbox"/> PER STATUTE <input type="checkbox"/> OTH-ER E.L. EACH ACCIDENT \$500,000 E.L. DISEASE - EA EMPLOYEE \$500,000 E.L. DISEASE - POLICY LIMIT \$500,000

DESCRIPTION OF OPERATIONS / LOCATIONS / VEHICLES (ACORD 101, Additional Remarks Schedule, may be attached if more space is required)

Proprietors/Partners/Executive Officers/Members Excluded:
 Diane Pickerel, Owner 100%

City of Lincoln, Nebraska; Lancaster County, Nebraska; Lincoln-Lancaster County Public Building Commission are named as Additional Insured on General Liability and Auto policies. A Waiver of Subrogation applies to the General Liability, and Workers Compensation Policies.

CERTIFICATE HOLDER **CANCELLATION**

City of Lincoln/Lancaster County & Lincoln/Lancaster County Public Building Commission 555 S 10th Street Lincoln, NE 68504	SHOULD ANY OF THE ABOVE DESCRIBED POLICIES BE CANCELLED BEFORE THE EXPIRATION DATE THEREOF, NOTICE WILL BE DELIVERED IN ACCORDANCE WITH THE POLICY PROVISIONS. AUTHORIZED REPRESENTATIVE 
--	---

THIS ENDORSEMENT CHANGES THE POLICY. PLEASE READ IT CAREFULLY.

ADDITIONAL INSURED – OWNERS, LESSEES OR CONTRACTORS – SCHEDULED PERSON OR ORGANIZATION

This endorsement modifies insurance provided under the following

COMMERCIAL GENERAL LIABILITY COVERAGE PART

SCHEDULE

Name Of Additional Insured Person(s) Or Organization(s)	Location(s) Of Covered Operations
City of Lincoln and Lancaster County and City of Lincoln/Lancaster County Public Building Commission	Multiple locations for The City of Lincoln/Lancaster County
Information required to complete this Schedule, if not shown above, will be shown in the Declarations.	

A. Section II – Who is An Insured is amended to include as an additional insured the person(s) or organization(s) shown in the Schedule, but only with respect to liability for "bodily injury", "property damage" or "personal and advertising injury" caused, in whole or in part, by:

1. Your acts or omissions; or
2. The acts or omissions of those acting on your behalf;

in the performance of your ongoing operations for the additional insured(s) at the location(s) designated above.

However:

1. The insurance afforded to such additional insured only applies to the extent permitted by law; and
2. If coverage provided to the additional insured is required by a contract or agreement, the insurance afforded to such additional insured will not be broader than that which you are required by the contract or agreement to provide for such additional insured.

B. With respect to the insurance afforded to these additional insureds, the following additional exclusions apply:

This insurance does not apply to "bodily injury" or "property damage" occurring after:

1. All work, including materials, parts or equipment furnished in connection with such work, on the project (other than service, maintenance or repairs) to be performed by or on behalf of the additional insured(s) at the location of the covered operations has been completed; or
2. That portion of "your work" out of which the injury or damage arises has been put to its intended use by any person or organization other than another contractor or subcontractor engaged in performing operations for a principal as a part of the same project.

C. With respect to the insurance afforded to these additional insureds, the following is added to **Section III – Limits Of Insurance:**

If coverage provided to the additional insured is required by a contract or agreement, the most we will pay on behalf of the additional insured is the amount of insurance:

1. Required by the contract or agreement; or

2. Available under the applicable Limits of Insurance shown in the Declarations;
whichever is less.

This endorsement shall not increase the applicable Limits of Insurance shown in the Declarations.

THIS ENDORSEMENT CHANGES THE POLICY. PLEASE READ IT CAREFULLY.

DESIGNATED INSURED

This endorsement modifies insurance provided under the following:

- BUSINESS AUTO COVERAGE FORM
- GARAGE COVERAGE FORM
- MOTOR CARRIER COVERAGE FORM
- TRUCKERS COVERAGE FORM

With respect to coverage provided by this endorsement, the provisions of the Coverage Form apply unless modified by this endorsement.

This endorsement identifies person(s) or organization(s) who are "insureds" under the Who Is An Insured Provision of the Coverage Form. This endorsement does not alter coverage provided in the Coverage Form.

This endorsement changes the policy effective on the inception date of the policy unless another date is indicated below.

Endorsement Effective: 06/23/2017	Countersigned By: (Authorized Representative)
Named Insured: Office Interiors and Design Inc.	

SCHEDULE

<p>Name of Person(s) or Organization(s): City of Lincoln, Lancaster County, and City of Lincoln-Lancaster County Public Building Commission</p>

(If no entry appears above, information required to complete this endorsement will be shown in the Declarations as applicable to the endorsement.)

Each person or organization shown in the Schedule is an "insured" for Liability Coverage, but only to the extent that person or organization qualifies as an "insured" under the Who Is An Insured Provision contained in **Section II** of the Coverage Form.

WAIVER OF OUR RIGHT TO RECOVER FROM OTHERS ENDORSEMENT

We have the right to recover our payments from anyone liable for an injury covered by this policy. We will not enforce our right against the person or organization named in the Schedule. (This agreement applies only to the extent that you perform work under a written contract that requires you to obtain this agreement from us.)

This agreement shall not operate directly or indirectly to benefit anyone not named in the Schedule.

Schedule

City of Lincoln, Lancaster County, and Lincoln-Lancaster County Public Building Commission.

This endorsement changes the policy to which it is attached and is effective on the date issued unless otherwise stated.

(The information below is required only when this endorsement is issued subsequent to preparation of the policy.)

Endorsement
Insured Office Interiors and Design, Inc.

Effective Policy No.
WCP101275903GIC

Endorsement No.
Premium

Insurance Company
Guarantee Insurance Company

Countersigned by _____

**YOU[®]
SIT FIT.**

allseating 



With its U-shaped back suspension, the You chair introduces a revolutionary way of sitting that lifts you into the proper position. Similar to sitting on a yoga ball, the You chair engages your core muscles, elongates the back, opens your chest and keeps your shoulders down and relaxed. That means you sit up tall and light on your sit bones.

© 2014 The Medical Office Furniture Company. All rights reserved. For more information, visit www.youchair.com.

1-800-800-8000
www.youchair.com

WHEN YOU SIT ALL DAY,
YOU NEED A CHAIR
THAT FUNCTIONS THE
WAY YOU DO.

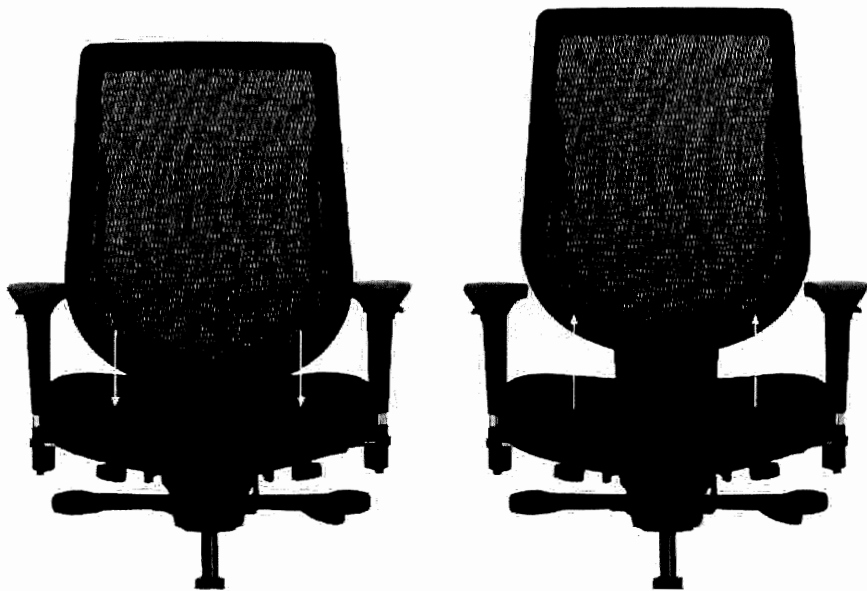

The U-shaped frame raises and lowers the back to the ideal height, setting the lumbar support in the optimal position. Simply reach back and lift or lower the frame as required.

U-SHAPED FRAME WITH MESH AND RIBBAGE, WITH LUMBAR SUPPORT
BACK AND UPHOLSTERED SEAT IN SOLID OASIS BLACK



The You frame features an activation dial that causes the mesh to bow and provide the precise support between the lumbar and ribcage, gently lifting you into the proper position. Simply turn the dial to increase or decrease the degree of curve in the mesh.

U-SHAPED FRAME WITH MESH AND RIBBAGE, WITH LUMBAR SUPPORT
AND UPHOLSTERED SEAT IN SOLID OASIS BLACK
MESH AND RIBBAGE

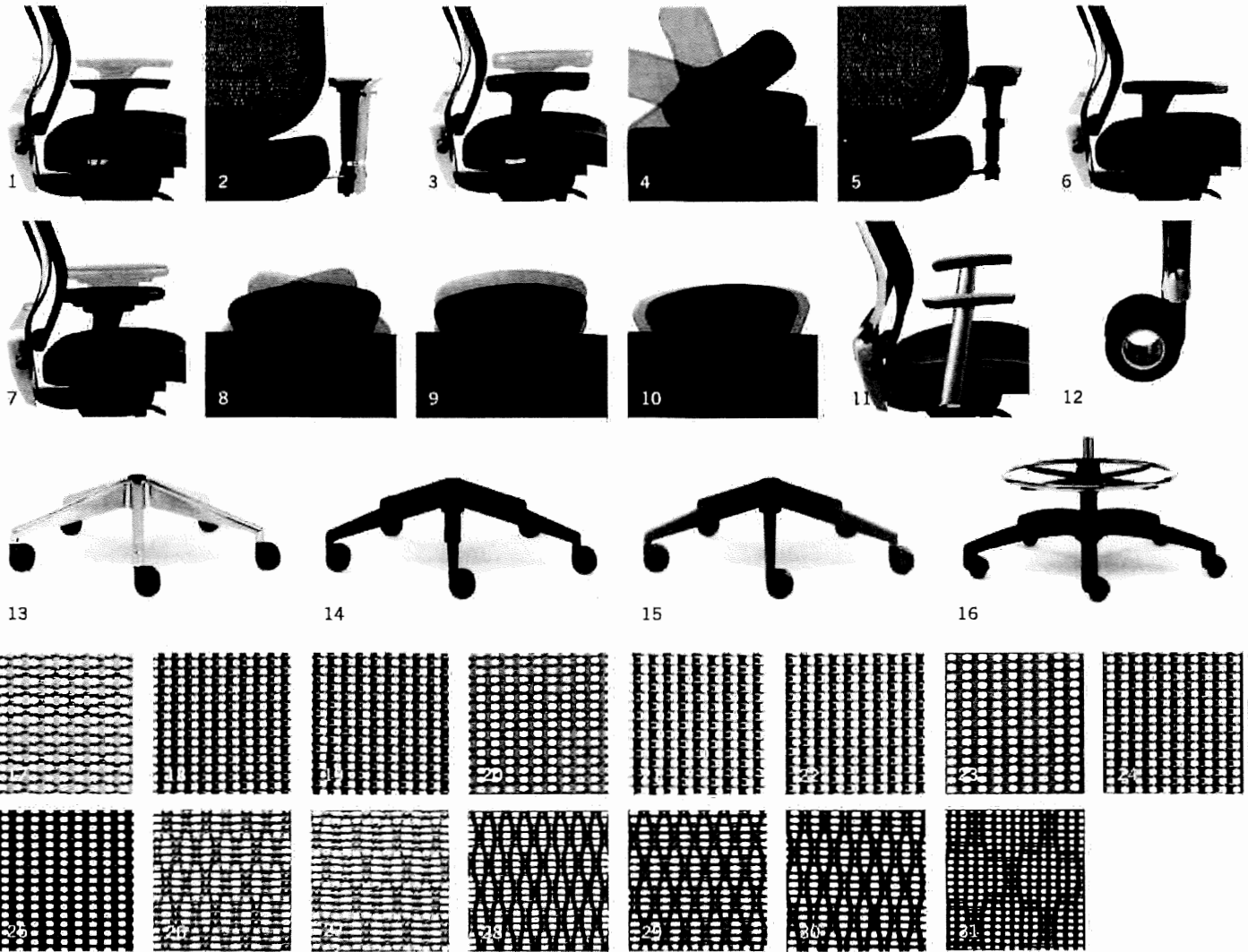

We bend over backwards to design ergonomic seating that makes people feel comfortable. Over the past 30 years, we've developed a reputation for quickly adjusting to the changing needs of customers in the office, education and healthcare sectors. From our on-time guarantee, to our on-line specification tools, we're always putting your needs first. So our clients are able to sit back and rest assured that, no matter what, the people at Allseating always have their back.

Our manufacturing system conforms to the ISO 9001:2008 and 14001:2004 standards, and our warranty is the best in the industry.

OPTIONS

- | | |
|---|----------------------------|
| 1 T2 ARM HEIGHT ADJUSTMENT | 17 M2 MESH ZINC |
| 2 T2 ARM WIDTH ADJUSTMENT | 18 M2 MESH COPPER |
| 3 TWISTER ARM HEIGHT ADJUSTMENT | 19 M2 MESH BRONZE |
| 4 TWISTER ARM ARM CAP PIVOT | 20 M2 MESH GOLD |
| 5 1D ARM ARM CAP PIVOT | 21 M2 MESH PATINA |
| 6 1D ARM ARM CAP SLIDES FRONT/BACK | 22 M2 MESH RHODIUM |
| 7 MULTI-FUNCTIONAL ARM HEIGHT ADJUSTMENT | 23 M2 MESH PLATINUM |
| 8 MULTI-FUNCTIONAL ARM ARM CAP PIVOT | 24 M2 MESH PEWTER |
| 9 MULTI-FUNCTIONAL ARM CAP SLIDES IN/OUT | 25 M3 MESH IRON |
| 10 MULTI-FUNCTIONAL ARM CAP SLIDES FRONT/BACK | 26 M3 MESH SANDSTONE |
| 11 CONFERENCE ARM | 27 M3 MESH SILICA |
| 12 DYNAMIC CASTER | 28 M3 MESH DARK GREY |
| 13 HIGH PROFILE ALUMINUM BASE | 29 M3 MESH COBALT |
| 14 BLACK TPO BASE | 30 M3 MESH EBONY |
| 15 SMOKE TPO BASE | 31 M4 MESH BLACK HONEYCOMB |
| 16 BLACK STOOL BASE | |

To learn more about You and You Too, visit allseating.com

Toronto Office: 5800 Avebury Road, Unit 2, Mississauga, ON L5R 3M3
 Chicago Office: Suite 210, 325 North Wells Street, Chicago, IL 60654
 New York Showroom: 1140 Broadway, Suite 902, New York, NY 10001
 www.allseating.com T 1 800 563 3502 F 1 800 272 9911

© 2014 Allseating Inc. All rights reserved.



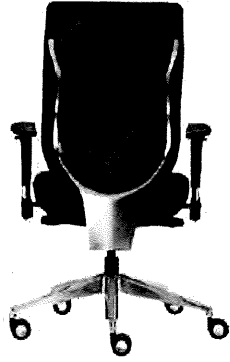

YOU[®] HIGHBACK

DESIGN | ALLSEATING
GSA SIN | 711-18

BASE PRICE | \$995
84112-NA

Grade 1/COM	Grade 2	Grade 3	Grade 4/COL	Grade 5	Grade 6	Grade 7	Grade 8	Leather 1	Leather 2	Leather 3
\$995	\$1,016	\$1,030	\$1,048	\$1,063	\$1,091	\$1,123	\$1,158	\$1,235	\$1,269	\$1,372

FEATURES

- Aluminum back frame
- 3.5" cylinder
- Black TVO nylon base
- Molded seat foam
- Innovative back suspension with standard back height adjustment
- Lumbar dial and back height support of 3.54"
- Arm features and travel specifications on page 16
- 24/7 Warranty offered with T2 arms and Seat Slider.
For more details see page 161

DIMENSIONS

- Overall: 42.5"- 46"H | 28"W | 28"D
- Upholstered Seat: 16.5"- 20"H | 21"W | 20"D
- Mesh Seat: 20"W | 18"D
- Back: 26"H | 18.75"W
- COM Seat: 0.75 yd

NOTES

- Ships knocked down.
- For BW and FA Freight Options, minimum quantities apply, please check with Sales Support for details.
- YCA Conference Arm is standard polished aluminum.
- All other features are dependant on the control specified. Please refer to Control Choice on Page 8 for full description of available features.
- This product meets the requirements set forth in ANSI-BIFMA X5.1-2011 and is warranted for users up to 325 lbs.
- Dimensions are dependant on options selected. Product can be configured to comply with BIFMA G1-2002 Guidelines.
- *LS Option not available when LH, HAB, OHC, OHH are selected. Composite base and matching casters will be substituted when LS or HS are selected.
- For mesh model code see page 22. Mesh seat will match mesh selection.

SERIES	84	You	72HR	\$
BACK STYLE	1	Highback	•	-
CONTROL	12	Deluxe Synchro Tilt (DST)	•	-
ARM	NA	No Arm	•	-
	T2	Task 2 Arm	•	\$105
	4D	4 Dimensional Arm	•	\$125
	MF	Multi Functional Arm (AWK included)	•	\$150
	TW	Twister Arm	•	\$174
	YCA	Conference Arm (AW not applicable)	•	\$214
FRAME FINISH	BK	Black Aluminum	•	-
	AL	Polished Aluminum	•	\$90
BACK MESH	M2	M2 Mesh not all colors are 72HR	•	\$25
(see page 22 for mesh model code)	M3	M3 Mesh	•	-
	M4	M4 Mesh	•	-
OPTIONS	AWK	Adjustable Width Brackets (Knob)	•	\$29
	MS	Mesh Seat	•	\$90
	HAB	High Profile Aluminum Base with 65mm (2.5") Casters	•	\$60
	LH	65mm (2.5") Hard Surface Casters	•	\$30
	OHC	OH Carpet Casters	•	\$60
	OHH	OH Hard Surface Casters	•	\$90
	SS	Seat Slider	•	\$79
	MED	Medium Upholstered Seat (20"W 18"D)	•	-
	LS	Low Seat Height with 5" Travel*	•	\$50
	HS	High Seat 5.5"*	•	-
	IES	Ergonomic Small Seat (16"D x 19"W)	•	-
FREIGHT OPTIONS	KD	Knocked Down	•	\$0
	BW	Blanket Wrapped (25 unit minimum)	•	\$40
	FA	Fully Assembled (25 unit minimum)	•	\$60

TO ORDER SIMPLY FILL IN THE BLANKS

84	1	12						
SERIES	BACK STYLE	CONTROL	ARM	FRAME FINISH	BACK MESH	OPTIONS <small>For additional options separate with (-) hyphen.</small>	FREIGHT OPTION	FABRIC CODE <small>Please refer to allseating.com for fabric codes.</small>

INFO
ASTUTE
AILES
CHRIFORM
DOVE
ENTAIL
FLUID
FOSTER
HALSA
INERTIA
JIF
LEVO
M.O.
MULTI
PRESTO
RAINBOW
RAN
REQUISITE
THERAPOD
TUCK
TRUST
YOU
ZIP

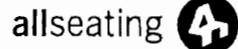

Our 10-year Parts and Labor Warranty

At Allseating, we pride ourselves in engineering products that stand up in today's demanding work environments. So if you receive a product from us that doesn't measure up to your expectations, we promise to swiftly investigate and solve the problem.

Seating and Work Tools

Our warranty is simple. We cover all our products and the components we use to make them – for 10 years. This includes pneumatic cylinders, foam, thermoplastics, urethanes, arm pads and mechanisms. And we pay for all preapproved labor costs.

Lighting

Allseating lighting products are covered for 1 year, assuming normal use 8 hours per day 5 days a week.

Warranty Resolution

We understand that dealing with warranties is often frustrating. So we developed a dedicated Warranty Response Team to eliminate any headaches. They're specially trained to expedite any warranty-related issue, so you can get back to business quickly and painlessly.

Contact our Warranty Response Team at warranty@allseating.com or toll free at 1(800)563-3502.

Applicable Provisions to All Products and Services

Allseating products, including those designated for Multi-Shift, are warranted to be free from defects in materials and workmanship for a period of 10 years from original date of purchase. This warranty applies to all chair models and extends to original purchasers who acquire new product directly from Allseating or our authorized dealers.

During the warranty period, Allseating, at its sole discretion, will repair or replace (at its option) any product, part or component covered by this warranty that fails under normal use due to defective materials or workmanship. Allseating will repair or replace the defective product, part or component with comparable product, part or component. To be eligible for this warranty coverage, all products, parts or



components must be installed, used and maintained in accordance with Allseating's published instructions and must not have been subject to misuse or abuse.

Allseating does not warrant the following:

- Failure resulting from normal wear and tear
- Natural variations, scars, marks or wrinkles occurring in leather
- Colourfastness of textiles
- Colour matching of textiles exactly to samples or swatches
- COM or COL fabrics
- Products exposed to extreme environmental conditions or improper storage conditions
- Chairs used by individuals who weigh in excess of 325 lbs.

Allseating's products meet the requirements of national and specific local codes as stated in the price book and other written publications. Please visit the company's website at allseating.com for further details regarding product specifications.

This document inclusively describes Allseating's warranty and remedies available with respect to the company's products and services. Allseating disclaims any other warranty whether express or implied, statutory or otherwise, in relation to the company's products and services.

To the extent allowed by law, any implied warranties, including any warranty of merchantability or fitness for a particular purpose, are disclaimed and to the extent they are legally required, are limited in duration to the duration of this written warranty.

Allseating shall not be liable for loss of time, inconvenience, commercial loss, or incidental or consequential damages.

big & tall

your style. your comfort. your health.



RFM seating

SIERRA 8536-C-12A Valor Mango

evolve

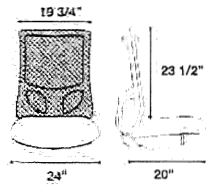

MANAGERS HIGH BACK BT15 AND BT16

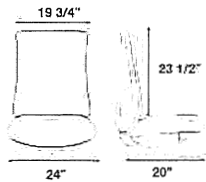

MANAGERS HIGH BACK BT17 AND BT18

MESH OPTIONS

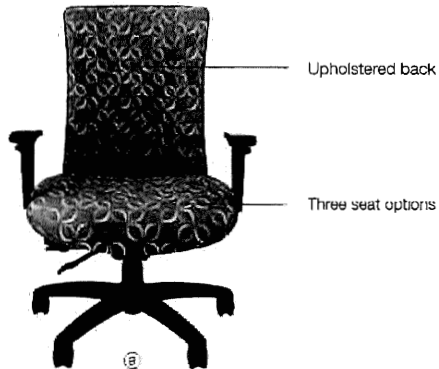
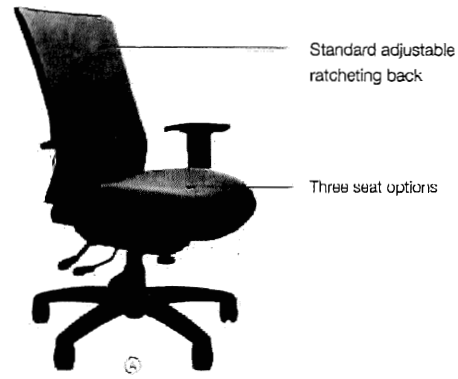
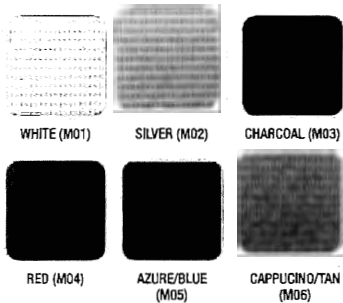

FEATURES & BENEFITS

- » Comfortably accommodates up to 400 lbs.
- » Heavy-duty base and casters
- » Meets CAL 117
- » Standard adjustable ratcheting back
- » 7 Mesh color options

internet

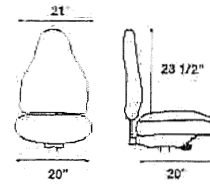

BT41 AND BT42

protask

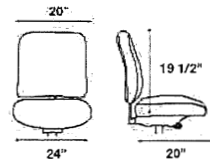

MEDIUM BACK BT51 AND BT52

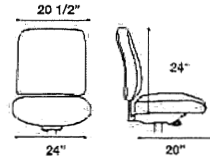

MANAGERS HIGH BACK BT55 AND BT56

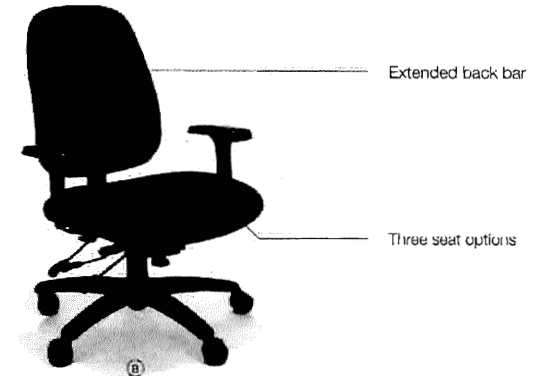
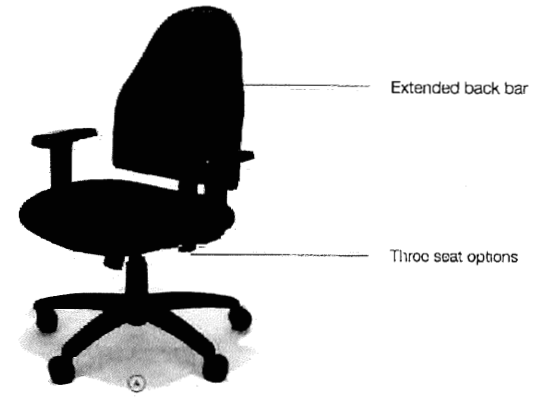

FEATURES & BENEFITS FOR BT INTERNET & BT PROTASK

- » Comfortably accommodates up to 400 lbs.
- » Heavy-duty base and casters
- » Extended back bar
- » Popular options include soft gel pad (77), R foam (25), air lumbar (60), and articulating headrest (65)

A: EVOLVE BT16-25A-M05 *Moguis Graphito*

B: BT EVOLVE BT18-B-25A *Medley Silvered*

A: BT INTERNET BT42-B-25A
Back: Shiraz Sky Seat: Dillon Ocean

B: BT PROTASK BT56-E-12A *Crihbaye Raisin*

metro

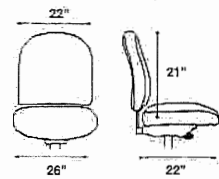

MEDIUM BACK 2006 AND 20050

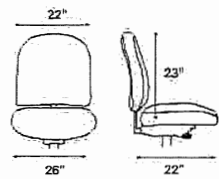
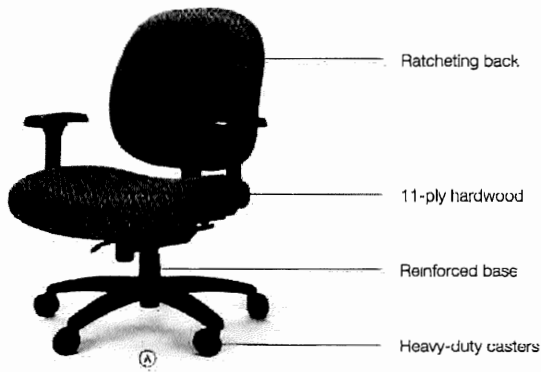

MANAGERS HIGH BACK 2086 AND 20850

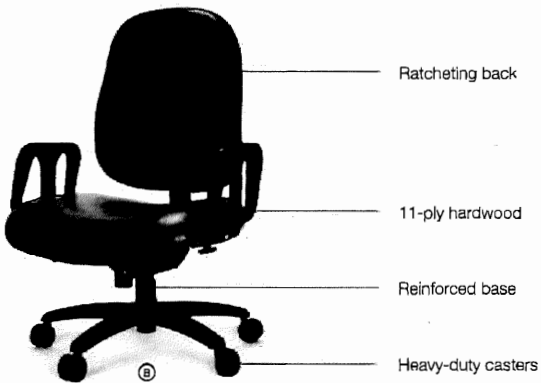

phoenix

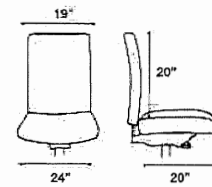

MEDIUM BACK BT21 AND BT22

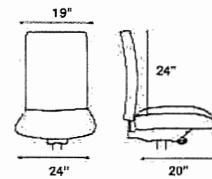
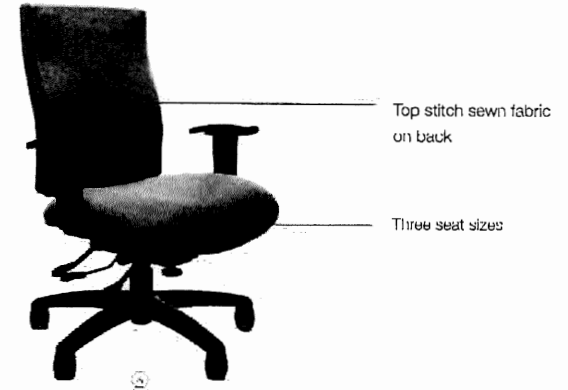

MANAGERS HIGH BACK BT23 AND ET24

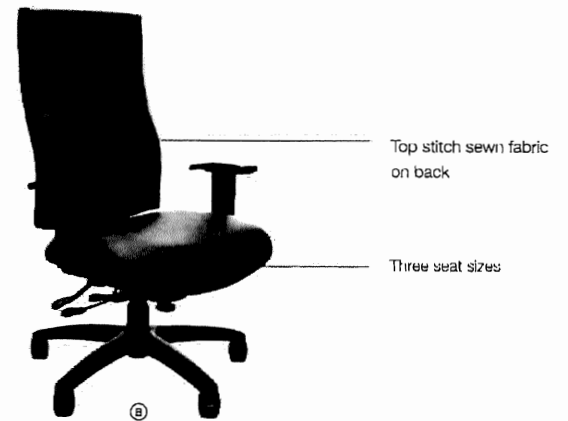

FEATURES & BENEFITS

- » Comfortably accommodates up to 500 lbs.
- » Back options include Medium and Managers High Back
- » Fully upholstered outback
- » Two control options, including 06-balance syncro, multi-function, heavy-duty 50 control

FEATURES & BENEFITS

- » Comfortably accommodates up to 400 lbs.
- » Heavy-duty base and casters

A: METRO 2006-B-12A *Maver Lucia Cassa Enigma - Copper*

B: METRO 2086-D-03A *Mayer Faux Leather Outback - Sardis*

A: BT PHOENIX BT22-B-25A *Bar glie Cork*

B: BT PHOENIX BT24-B-25A *Dillon Java*

sierra

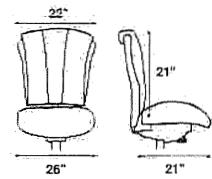

MEDIUM BACK 8526 AND 85250



- Double padded back
- Air lumbar available
- Dual density seat foam standard
- Three seat options

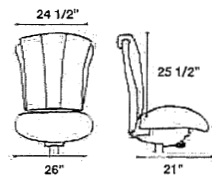

MANAGERS HIGH BACK 8536 AND 85250



- Double padded back
- Air lumbar available
- Dual density seat foam standard
- Three seat options

FEATURES & BENEFITS

- » Comfortably accommodates up to 500 lbs
- » Back options include Medium and Managers High Back
- » Black air mesh outback

- » Custom body fit with ratchet back standard and air lumbar optional
- » Available options include conference arms, three seat sizes and articulating headrest

A: SIERRA 8526-G-25A *Momentum Rio Gold*

B: SIERRA 8536-C-12A *Vakr Mango*

tech

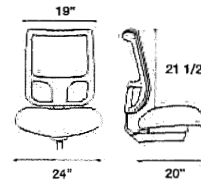

MEDIUM BACK BT11 AND BT12



- Air mesh back
- Reinforced base
- Heavy-duty casters

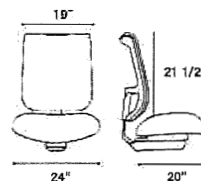

MANAGERS HIGH BACK BT13 AND BT14



- Fully upholstered back
- 11-ply reinforced seat wood

MESH OPTIONS

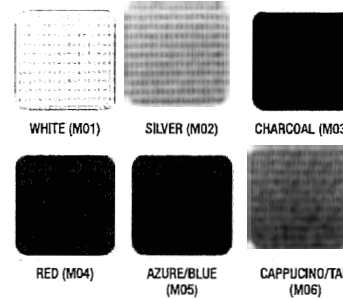

FEATURES & BENEFITS

- » Comfortably accommodates up to 400 lbs.
- » 28" black nylon reinforced base
- » Heavy-duty casters
- » Available with three seat sizes

A: BT TECH BT11-F-25A *Tesla Nickel*

B: BT TECH BT14-B-25A *Foundation X Mercury*

trademark

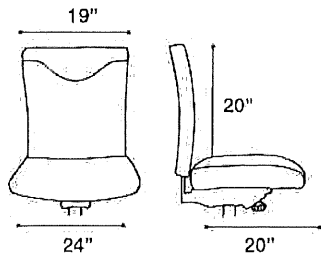

MEDIUM BACK BT25 AND BT26

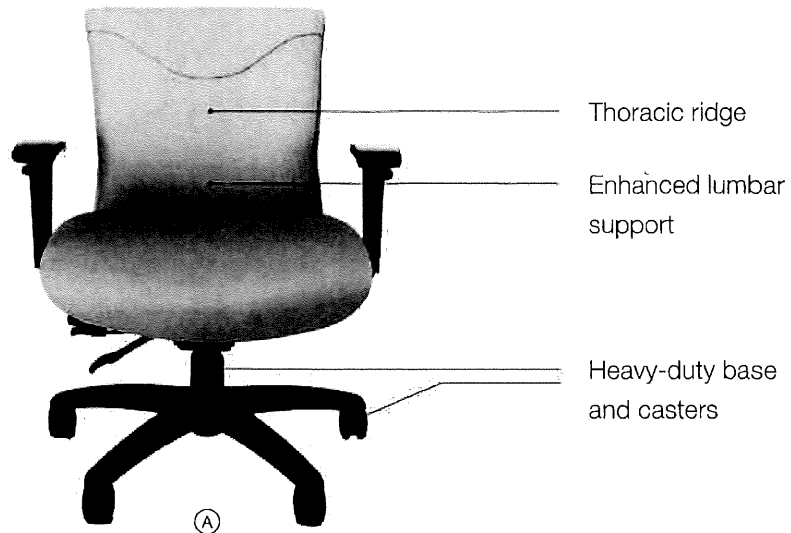

(A)

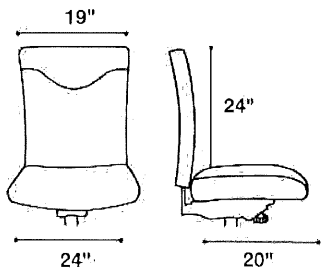

MANAGERS HIGH BACK BT27 AND BT28

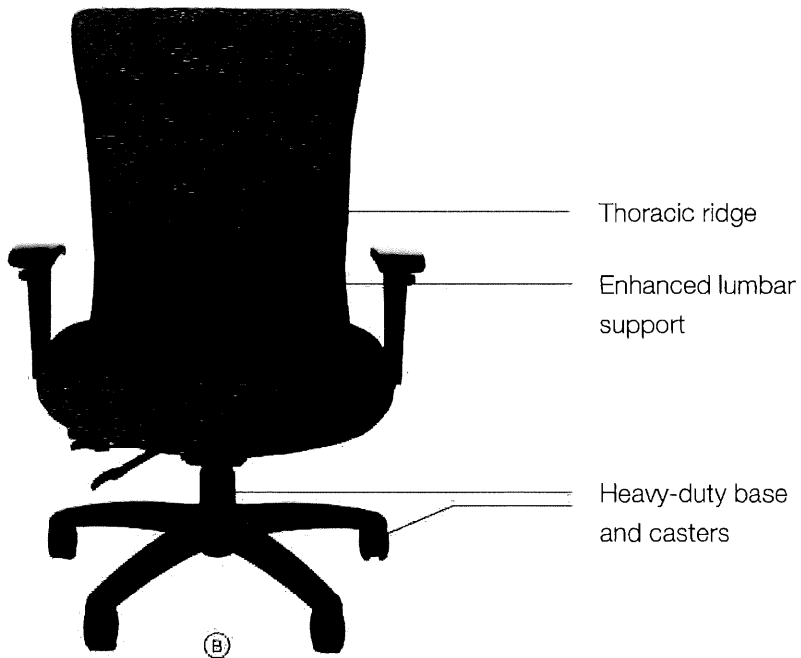

(B)

FEATURES & BENEFITS

- » Comfortably accommodates up to 400 lbs.
- » Available options include three seat sizes, air lumbar, and articulating head rest
- » Standard adjustable ratcheting back
- » Top stitch sewn fabric on back

A: BT TRADEMARK BT26-B-25A *Dillon Buff*

B: BT TRADEMARK BT28-B-25A
Winslow Blue Chip



RFM seating

619 S.W. Wood Street | Hillsboro, OR 97123

503.648.6121 800.447.5542 Fax: 800.734.6377

www.rfmseating.com

EVOLVE 1500

STANDARD FEATURES

- Accommodates up to 400lbs
- Meets CAL 117-2013
- 28" black nylon reinforced base
- 70mm heavy-duty casters
- Height adjustable, black mesh back
- Heavy-duty back bar
- Standard seat height approx. range for model pictured (floor to top of seat): 18 1/2" to 22" (with 100mm cylinder)

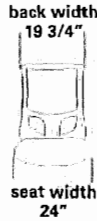

Model BT15

OPTIONS See pages 121-122 for additional options

Not available: 04, 08, 09, 18, 23, 24 & 37 Arms; 33 Seat Slider

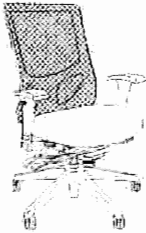

BT15 Task

MANAGERS HIGH BACK Enhanced ratchet back swivel tilter 07-control

Arm	B	C	D	E	F	G	L
		(com)		(col)			
Armless	709	732	765	810	871	968	1158

BT16 Task

MANAGERS HIGH BACK Ratchet back with heavy duty, multi-function infinite tilt lock 50-control w/ longer, easy-access cylinder paddle

Arm	B	C	D	E	F	G	L
		(com)		(col)			
Armless	734	757	790	835	896	993	1183

STANDARD FEATURES

- Accommodates up to 400lbs
- Meets CAL 117-2013
- 28" black nylon reinforced base
- 70mm heavy-duty casters
- Height adjustable, upholstered back
- Heavy-duty back bar
- Standard seat height approx. range for model pictured (floor to top of seat): 18 1/2" to 22" (with 100mm cylinder)



Model BT18

OPTIONS See pages 121-122 for additional options

Not available: 04, 08, 09, 18, 23, 24 & 37 Arms; 33 Seat Slider



BT17 Task

MANAGERS HIGH BACK Enhanced ratchet back swivel tilter 07-control

Arm	B	C	D	E	F	G	L
		(com)		(col)			
Armless	829	852	885	930	991	1088	1278

BT18 Task

MANAGERS HIGH BACK Ratchet back with heavy duty, multi-function infinite tilt lock 50-control w/ longer, easy-access cylinder paddle

Arm	B	C	D	E	F	G	L
		(com)		(col)			
Armless	854	877	910	955	1016	1113	1303

SEAT SIZE OPTIONS

	LIST PRICE
2021 X-Small 24 w x 18 d	N/C
2022 Small 24 w x 19 d	N/C
2024 Large 24 w x 21 d	N/C

BT POPULAR OPTIONS

- #70P Extra thick, soft arm pad 10
- #25F RFoaM 75
- #60L Air Lumbar 125
- #65HR Articulating Headrest 326
- #24/7 Upgrade 350

Effective October 1, 2016

RFM PRODUCT WARRANTY

RFM Seating products are engineered to provide many years of use under normal conditions when cared for properly. Normal conditions are defined as an office environment during a single shift consisting of 8-hour days, 5 days a week for a user weighing 300 pounds or less. Products manufactured by RFM carry the following limited lifetime warranties to the original purchaser:

- **SEAT AND BACK FABRIC IS COVERED FOR FIVE YEARS AND NOT WARRANTED OR MULTI-SHIFT OPERATIONS**

All ergonomic, task & conference chairs:

Lifetime warranty on cylinder, 12 years on all other parts.

All Multi-Shift and Nurse's Station:

7 year warranty on all parts.

All Big and Tall chairs:

Lifetime warranty on cylinder, 7 years on all other parts.

All guest and lobby chairs:

Lifetime warranty on all steel and wood frames,
5 years on all other components.

Essentials chairs:

5 years on all components.

THE ABOVE WARRANTIES EXCLUDE THE FOLLOWING:

- Any product, which has been repaired or altered by the customer.
- Any variation in color, grain, or texture of wood, leather, or fabric.
- Any incidental damage resulting from the neglect or inability to use RFM products properly with regular maintenance.
- Any normal wear and tear. The warranty is a protection from defects only.
- **Warranties are NOT transferable.**

To make claim under this warranty, the claim must be processed through the original dealer of purchase. The dealer will inspect for warranty qualifications and may obtain a return material authorization (RMA) number from RFM. RFM shall provide, at our option, parts, replacements or monetary adjustments. Labor is not covered under warranty. The warranties indicated above are the only warranties made by RFM and no other warranties expressed or implied are given on products manufactured by RFM.

The return of products will NOT be accepted without an RMA number issued by RFM Customer Service. All returned products must be protected to prevent damage in transit and shipped pre-paid.

TORSA TASK CHAIR



Cutting-edge design and the ability to personalize frame, arm, and mesh color combinations make Torsa the natural preference for a fresh, clean style. The innovative cable-driven synchro mechanism with Comfort Drive® allows easy fingertip adjustment from a seated position. And remarkably, excellent ergonomics come standard with adjustable lumbar support and seat depth adjustment.

INSPIRED BY NATURE.



GOOD :: \$747

Enhanced synchro mechanism with Comfort Drive, seat depth adjustment, fixed nylon arms, nylon base, grade 1 textile.



BETTER :: \$787

Enhanced synchro mechanism with Comfort Drive, seat depth adjustment, multi-adjustable nylon arms, nylon base, grade 1 textile.



BEST :: \$953

Enhanced synchro mechanism with Comfort Drive, seat depth adjustment, fixed polished aluminum arms, polished aluminum base, grade 1 textile.

TORSA

CATEGORY: TASK CHAIR

COLLECTION: TORSA

BASE PRICE: \$787

GSA SIN #: 711-18

1. Back Information

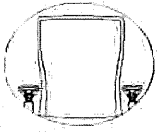
Back Size and Style	Code	Price	
Highback Mesh	6023	+ \$0	

2. Mechanism Information

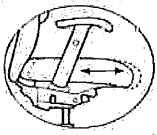

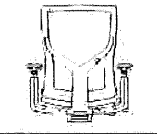
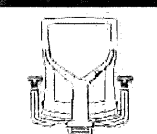

Mechanism	Code	Price	
Enhanced Synchro with Comfort Drive and Seat Depth Adjustment	Y/E3	+ \$0	

3. Frame Information

Frame Color	Code	Price	
Graphite	FC11	+ \$0	
White	FC12	+ \$0	
Back Support Color	Code	Price	
Graphite	Z3	+ \$0	
White	Z4	+ \$0	

4. Arm Information

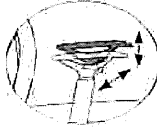
Arm color will match back support color. Fixed polished aluminum arms available with either back support color.

Arms	Code	Price	
Armless	A0	- \$78	
Fixed Nylon	A132	- \$40	
Multi-Adjustable (height/width)	A134	+ \$0	
Fixed Polished Aluminum	A131	+ \$53	

Torsa base price includes highback mesh enhanced synchro with Comfort Drive[®] and seat depth adjustment, multi-adjustable nylon arm, nylon base and grade 1 textile.

FEATURES:

- Cutting-edge design
- 4 frame/arm color combinations and 10 mesh colors
- Enhanced Synchro with Comfort Drive and seat depth adjustment
- Adjustable lumbar support
- Textured control knobs
- Comfortable and durable mesh back
- Waterfall seat
- CAL 133 approved models
- 300 lb. weight capacity
- Lifetime Warranty
- All options and 1,000s of textiles ship in 2, 5 or 10 days

5. Base Information

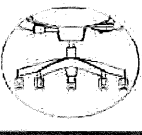
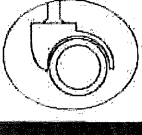
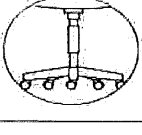
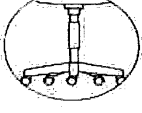
Base and Color	Code	Price	
Graphite Nylon Base	B14	+ \$0	
White Nylon Base	B20	+ \$0	
Polished Aluminum Base	B16	+ \$113	
Casters	Code	Price	
Carpet Casters	C25	+ \$0	
Hard Floor and Carpet Casters	C26	+ \$40	
Glides for Task Chairs	C3	+ \$30	
Designer Casters	C30	+ \$119	
Cylinder Height	Code	Price	
Standard Cylinder	S0	+ \$0	
Higher Cylinder	S13	+ \$0	

6. Material

CAL 133	Code	Price	
CAL 133, Fabric, Quantities 1-49	133F	+ \$99	
CAL 133, Fabric, Quantities 50+	133F5	+ \$55	
CAL 133, Leather, Any Quantity	133L	+ \$119	
Mesh Color	Code	Price	
Desert Solid Mesh	MC9	+ \$0	
Desert Striped Mesh	MC16	+ \$0	
Electric Blue Solid Mesh	MC13	+ \$0	
Fire Solid Mesh	MC10	+ \$0	
Fog Solid Mesh	MC7	+ \$0	
Fog Striped Mesh	MC15	+ \$0	
Navy Solid Mesh	MC8	+ \$0	
Nickel Solid Mesh	MC6	+ \$0	
Onyx Solid Mesh	MC5	+ \$0	
Onyx Striped Mesh	MC14	+ \$0	
Seat Textile	Code	Price	
COM or Fabric Grade 1	COM/FG1	+ \$0	
Fabric/Vinyl Grade 2	FG2	+ \$26	
Fabric/Vinyl Grade 3	FG3	+ \$60	
Fabric/Vinyl Grade 4	FG4	+ \$116	
Fabric/Vinyl Grade 5	FG5	+ \$172	
Fabric/Vinyl Grade 6	FG6	+ \$213	
Fabric/Vinyl Grade 7	FG7	+ \$254	
COL or Leather Grade 1	COL/LG1	+ \$300	
Leather Grade 2	LG2	+ \$380	
Leather Grade 3	LG3	+ \$480	

Specify textile details in Price Calculation section

TORSA®

TORSA

7. Packaging

Packaging	Code	Price	
Knocked Down	KD	+ \$0	
Back Attached to Seat, Base Separate	UC	+ \$30	
Fully Assembled in a Carton	AC	+ \$80	

SPECIFICATIONS

Model:	6023 Highback
Overall Width Armless	27
Overall Width with Arms	27
Overall Depth	27.125
Overall Height	44.5
Seat Width	19
Seat Depth	18-20.25
Seat Height (higher cylinder)	17.36-21.75 (S13) 19-23.75
Back Width	19
Back Height	22
Weight Armless	45 lbs.
Weight with Arms	50 lbs.
COM	1.1 yds.
COL	20 sq. ft.
Weight Capacity	300 lbs.

Dimensions are in inches.



FINAL PRICE CALCULATION

Category	Code	Price
Base Price		\$787
1. Back Information		
Back Size and Style		\$
2. Mechanism Information		
Mechanism		\$
3. Frame Information		
Frame Color		\$
Back Support Color		\$
4. Arm Information		
Arms		\$
5. Base Information		
Base and Color		\$
Casters		\$
Cylinder Height		\$
6. Material		
CAL 133		\$
Mesh Color		\$
Seat Textile/Please Specify:		\$
Textile Manufacturer:	_____	
Textile Pattern:	_____	
Textile Colorway:	_____	

7. Packaging		\$
--------------	--	----

TOTAL PRICE: \$ _____

QUANTITY: _____

REQUESTED DELIVERY DATE: _____

TORSA COMFORT DRIVE

FEATURE
SPOTLIGHT

SitOnIt • Seating®



TORSA COMFORT DRIVE: Cable-driven control.

The Torsa™ highback task chair with Comfort Drive™ offers outstanding ergonomics, exceptional comfort and a stylish yet affordable aesthetic.

SYNCHRO WITH COMFORT DRIVE

The innovative cable-driven synchro mechanism with Comfort Drive allows easy fingertip adjustment from a seated position.

Comfort Drive puts all of the functionality of the chair at the user's fingertips. Controls are located at the edge of the seat so users don't need to take their back off the chair. They can merely reach down, actuate the lever with their fingertips, and transform the chair to their liking.

STANDARD EQUIPMENT

Comfort Drive and seat depth adjustment are standard on all Torsa task chairs.

Enhanced synchro mechanism.



Left side: Seat height adjustment, seat depth adjustment



Right side: Tilt lock and tilt tension adjustment

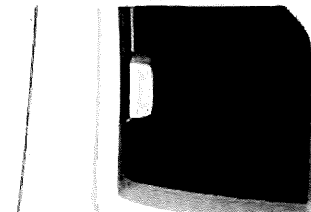

Adjustable lumbar support

Inspired by nature.

SitOnIt • Seating®

Inspirational design and cable-driven control coupled with adjustable lumbar support and seat depth adjustment make Torsa a superb task choice.

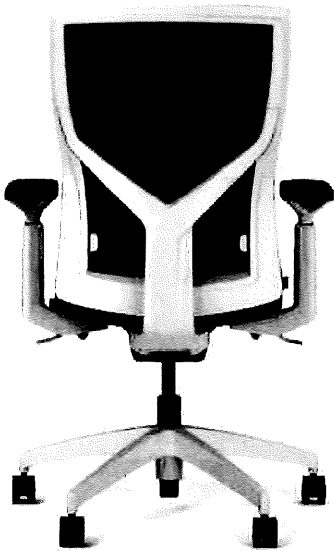

Inspirational design and cable-driven control coupled with adjustable lumbar support and seat depth adjustment make Torsa a superb task choice.

TORSA MODELS

- Highback Mesh

TORSA FEATURES

- Curving-edge design
- 4-frame/arm/back support color combinations
- 10 bleach cleanable mesh colors
- Synchro with Comfort Drive™
- Adjustable lumbar support and seat depth adjustment
- Textured control knobs
- Comfortable and durable mesh back
- 3 arm styles
- 3 base colors
- Designer or solid graphite casters
- Waterfall seat
- 300 lb. weight capacity
- Lifetime Warranty: 12-Years for 24/7 use
- All options and thousands of fabrics ship in 2, 5 or 10 days

SitOnIt • Seating®

For more information please visit us at sitonit.net
tel (888) 274-8664 • fax (714) 995-4855 • sales@sitonit.net
6415 Katella Avenue, Cypress, CA 90630

SitOnIt, Comfort Drive and Torsa are trademarks or registered trademarks of Exemplis Corporation. All other trademarks are property of their respective owners.
©2015 Exemplis. Printed in USA.



customizing opportunities

The Texas high back chair is available in four frame arm, back support color combinations and an incredible range of 40 mesh colors and patterns, including stripes and solids. Composite, white and polished aluminum case options offer even greater opportunity to express an individual or corporate personality.

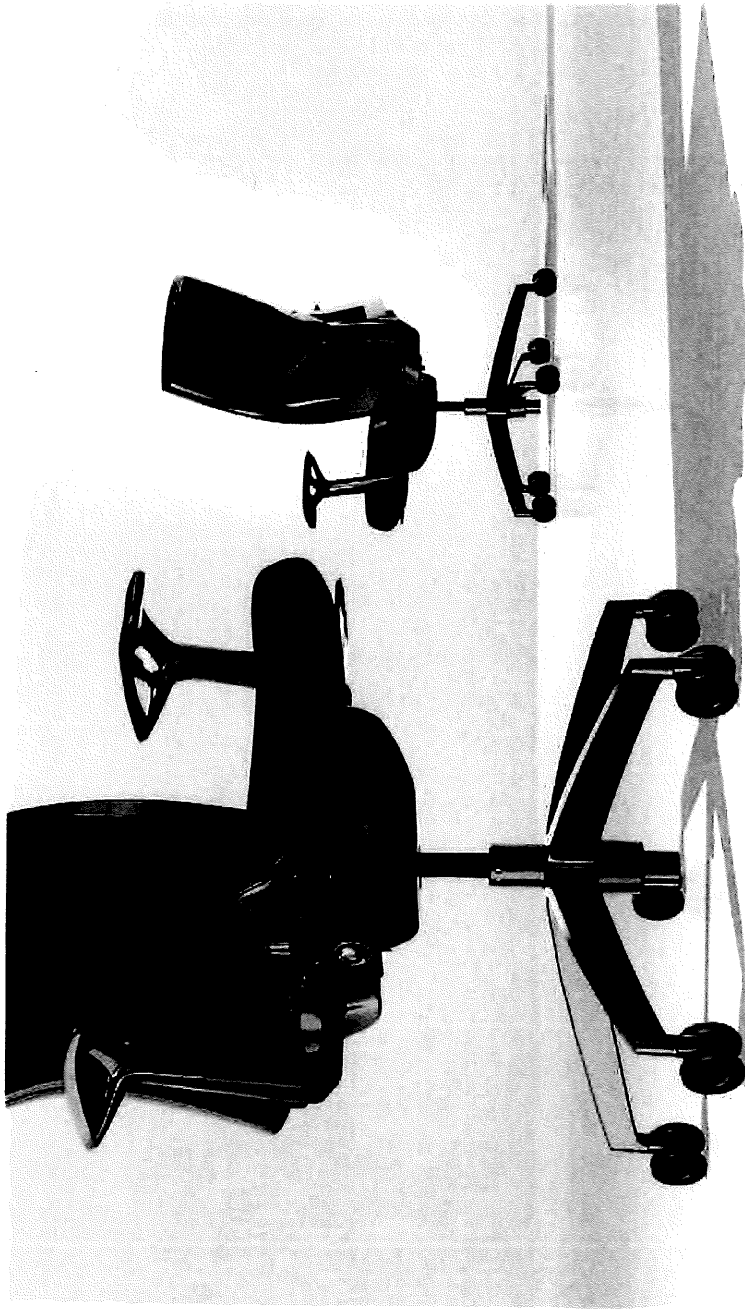

Frame Options

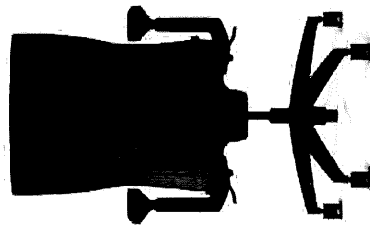

3-Phase frame with ergonomically designed armrests

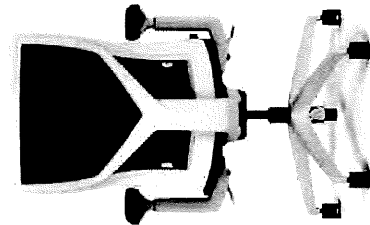

Y-Frame design with adjustable back support

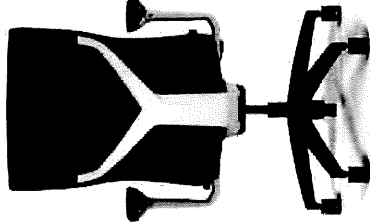

Available frame with adjustable back support

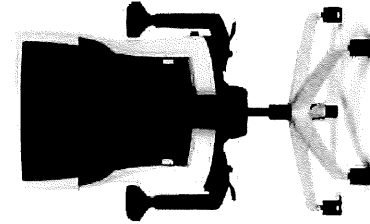

Y-Frame design with adjustable back support

TEXTILES: For more information, visit www.ergonomics.com

Prava®

SitOnIt • Seating®

Command performance.





JORGE PENSI

Known for his fluid, elegant aesthetic, award-winning furniture and lighting designer Jorge Pensi creates timeless pieces that adapt easily to multiple environments. Pensi studied architecture in his native Buenos Aires before moving to Barcelona and establishing his design practice there in 1984. During Spain's new design movement, Pensi emerged as one its key players with his more modern, universally appealing style.

Our Prava's mixed-media arm bears Pensi's signature, cast-aluminum design—the contemporary fusion of aluminum and plastic adds a subtly modern touch to any room.

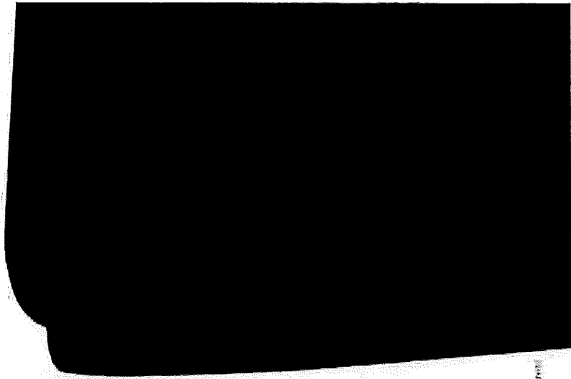

Orbita Grossi (Pensi)
© 2013 Pensi

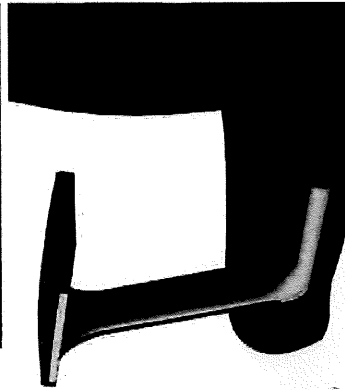

Orbita Grossi (Pensi)
© 2013 Pensi

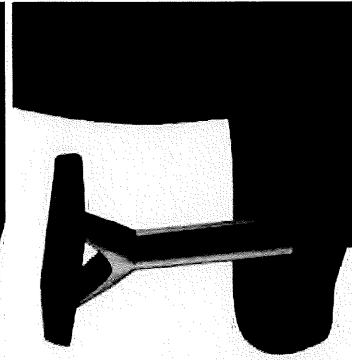

Orbita Grossi (Pensi)
© 2013 Pensi

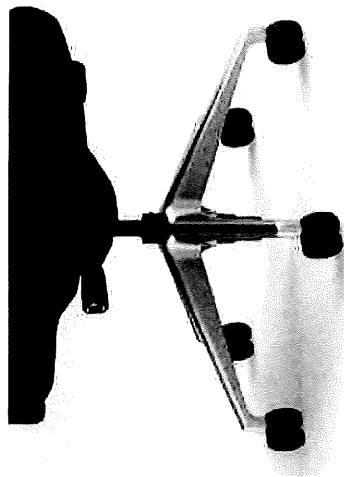

Orbita Grossi (Pensi)
© 2013 Pensi

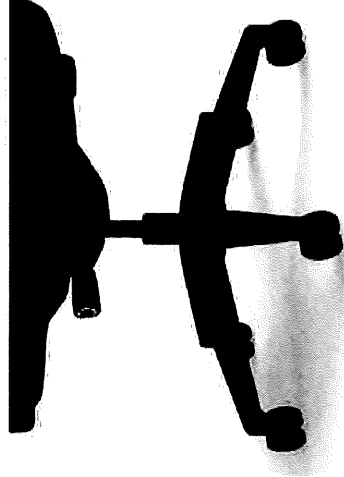

Orbita Grossi (Pensi)
© 2013 Pensi

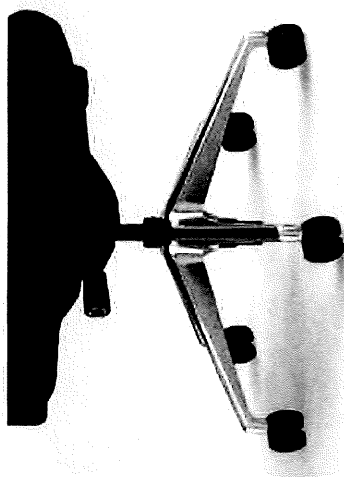

Orbita Grossi (Pensi)
© 2013 Pensi

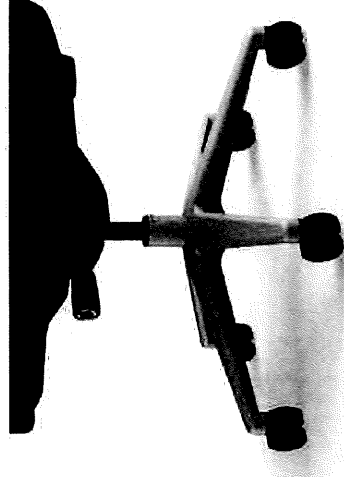

Orbita Grossi (Pensi)
© 2013 Pensi

Details Make The Difference

A wide array of control and control options are available including 360° arm swivel, choice of swivel tilt, knee lift or enhanced synchro adjustments, and three types of high-back flexibility. Modern and sophisticated with restrained elegance, Prava embodies the precise balance between refinement and comfort.



TEXTILES: Cognac mesh back, black leather



TEXTILES: Naked mesh back, Meridian Fine-grain leather

TEXTILES: Slate mesh back, Avon Com Silverado Parsley leather

for the executive suite

Distinguished cutting-edge design allows for individual expression.

intuitive control,
unrivaled comfort

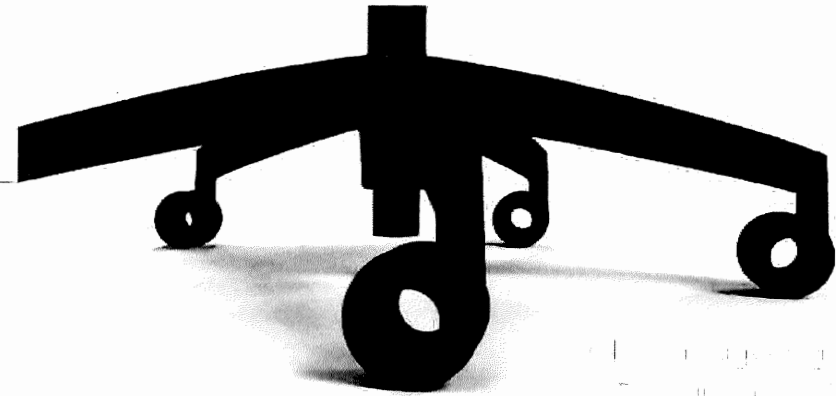

Fine-Tuned Comfort



High side: Seat height adjustment, seat depth adjustment



High side: Tilt lock and tilt tension adjustment



Adjustable lumbar support



Arm Options



Fixed nylon arm



Fixed nylon graphite



Fixed aluminum



Multi-adjustable thought width nylon chair



Multi-adjustable thought width nylon graphite

Base



Graphite



White



Polished aluminum

Casters



Decorative graphite



Graphite

Torsa

Features

- Flexible, body conforming mesh for superlative comfort and durability.
- Cable-driven synchro-tilt mechanism with Comfort Drive allows easy fingertip adjustment from a seated position.
- Adjustable integrated lumbar support and seat depth adjustment are standard.
- Waterfall seat promotes proper leg circulation.
- 300-lb. weight capacity.

Model	Weight Capacity	Weight	Dimensions (H x W x D)
Torsa 1000	300 lbs.	35 lbs.	45" x 22" x 22"
Torsa 1000	300 lbs.	35 lbs.	45" x 22" x 22"
Torsa 1000	300 lbs.	35 lbs.	45" x 22" x 22"
Torsa 1000	300 lbs.	35 lbs.	45" x 22" x 22"
Torsa 1000	300 lbs.	35 lbs.	45" x 22" x 22"
Torsa 1000	300 lbs.	35 lbs.	45" x 22" x 22"
Torsa 1000	300 lbs.	35 lbs.	45" x 22" x 22"
Torsa 1000	300 lbs.	35 lbs.	45" x 22" x 22"
Torsa 1000	300 lbs.	35 lbs.	45" x 22" x 22"
Torsa 1000	300 lbs.	35 lbs.	45" x 22" x 22"

© 2011 Herman Miller. All rights reserved.





Specifications

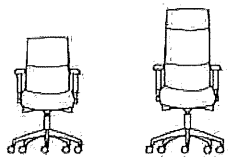

MODEL	6422 MIDBACK	6423 HIGHBACK
Overall Width Armless	19	19
Overall Width with Arms	27	27
Overall Depth	22.5	22.5
Overall Height	43.125	45.125
Seat Width	19	19
Seat Depth	19	19
Seat Height (mechanism)	(T/K) 17.825-20.625 (N) 19-22	(T/K) 17.5-20.5 (N) 19-22
Back Width	18	18
Back Height	23	25.5
Weight Armless	42 lbs.	44 lbs.
Weight with Arms	50 lbs.	52 lbs.
COM	2.5 yds.	2.85 yds.
FOU	10 sq. ft.	11 sq. ft.
Weight Capacity	300 lbs.	300 lbs.

Dimensions are in inches.

Features

- Sleek European styling
- Soft, plush foam back
- Perimeter foam for a tailored profile
- Jorge Pensi design
- Double stitch detailing
- Silver metallic options
- Waterfall seat
- Lifetime Warranty
- 300 lb. weight capacity
- All options and 1000s of textiles ship in 2, 5 or 10 days

Options

BACK STYLE	MECHANISM
<ul style="list-style-type: none"> • Midback • Highback 	<ul style="list-style-type: none"> • Swivel Tilt • Knee Tilt • Enhanced Synchro • Seat Depth Adjustment (synchro mechanism only)
BASE	ARM
<ul style="list-style-type: none"> • Black • Silver Metallic • Polished Aluminum • Brushed Aluminum 	<ul style="list-style-type: none"> • Armless • Fixed Loop (black or silver) • Fully Adjustable (5-way) (black or silver) • Fully Multi-Adjustable (8-way) (black or silver)
HEADREST	
<ul style="list-style-type: none"> • Matches Chair Textile • Black Criss Cross • Brown Criss Cross 	



FRONT COVER HIGHBACK TEXTILE: Green Hides Rally, Espresso
 BACK COVER MIDBACK TEXTILE: Green Hides Lena Cover, HIGHBACK TEXTILE: Green Hides Mahogany

SitOnIt • Seating®

For more information please visit us at sitonit.net
 tel (888) 274-8664 • fax (714) 995-4855 • sales@sitonit.net
 6415 Katella Avenue, Cypress, CA 90630

Form No. C166 01/17 2K

SitOnIt and Prava are trademarks or registered trademarks of Exemplis.
 All other trademarks referenced are the property of their respective owners.
 ©2017 Exemplis. Printed in USA. 01/17/186

SITONIT SEATING AND IDEON LIMITED WARRANTY

Exemplis LLC, SitOnIt Seating and IDEON (hereafter referred to as the Company), warrants to the original end user that this product will be free from defects in its material and workmanship when used in a single shift (standard 8-hour day, 5 days per week) for the following warranty periods:

Lifetime Warranty Coverage:

- All SitOnIt Seating products, except where noted below.

12-Year Warranty Coverage:

- Amplify, Torsa, Wit and Novo used in multi-shift (24/7) applications.

10-Year Warranty Coverage:

- Non-Stop Heavy Duty and chairs purchased with a Heavy Duty ("HD") option used in multi-shift (24/7) applications.
- All IDEON seating and tables.

5-Year Warranty Coverage:

- Fabric, foam, knit back, mesh and plastic.
- Power modules and electrical components

2-Year Warranty Coverage:

- Fabric and foam cushioning for Non-Stop Heavy Duty, Freelance Heavy Duty and chairs purchased with an HD option.

THE COMPANY DOES NOT WARRANT

- COM/COL textiles
- Product abuse or misuse or negligence in misuse
- Failure resulting from normal wear and tear
- Products that have been modified or altered and any attachments to the product
- Products or parts not used, maintained or installed in accordance with the Company's installation, maintenance and/or applicable guidelines
- Products that are exposed to extreme environmental conditions such as water damage or and/or have been subject to improper storage
- Floor samples or display models
- Products purchased "as is" and/or secondhand
- Products sold by unauthorized dealers
- Creasing and/or gathering of textiles during upholstery application process

- Minor irregularities of color, surface, grain and texture
- Minor variations of color in textiles
- Variations of texture and natural markings such as neck wrinkles, scratches, backbone marks and stretch marks in leather
- Color matching of textiles exactly to samples, swatches or prior purchases

APPLICABLE PROVISIONS TO ALL PRODUCTS AND SERVICES

The Company will, at its option, repair or replace with a comparable product, without charge to the original purchaser, only defective products or parts found defective during the Warranty Period. If requested by the Company, the original purchaser must return the part or product with freight or other shipping charges prepaid.

Under no circumstances will the company be liable for injuries or damages arising from use of the product.

This warranty shall be effective for the applicable time period beginning from date of purchase as shown on original purchaser's original receipt or other proof of purchase.

For products purchased on or after August 1, 2012, the Company shall pay for all labor costs pre-approved by the Company. The payment of such pre-approved labor costs will be in the form of a credit to an active Company account.

This is an **EXCLUSIVE LIMITED WARRANTY**.

There are no other warranties, expressed or implied, including without limitation, any implied warranty of merchantability or fitness for a particular purpose. The Company will not be responsible for incidental or consequential, special, or indirect damages. The purchaser is responsible for determining suitability for its intended use. The Company disclaims any liability for defects, loss of use, or claims or injuries arising out of the incorrect choice of product for particular usage. Some states do not allow the exclusion or limitation of incidental or consequential damages, so the above limitations or exclusions may not apply to you. This warranty gives you specific legal rights and you may have other rights

which vary from state to state.

The Company will advise you of the procedure to follow when making warranty claims. Call the Company at the number below to explain the defect. Give your name, address, and telephone number. Please be prepared with the model number and sales order number found under the seat of the chair.

features

at rest / the upright

- A curved back provides a back support in the sitting position
- Back height, lumbar support of the upper back to the lumbar lordosis and neck stress
- Adjusted lumbar support helps distribute weight evenly to create a healthy posture while seated
- Arm supports adjust in height or in angle available to meet diverse people's needs

in use

- Max. tension sensor that senses tilt and angle of the back to be available for a fixed back, or recline, adjustment options
- Sensing tilt, lumbar curves, etc. for better lumbar support of back, etc. for a better sitting posture
- Multi-tilt allows for independent adjustment of the back angle and seat tilt for back's center of gravity and lumbar and sitting posture back tilted for posture, etc. in use
- Special tilt back holds in upright position in its flows. Has one include tilt angle adjustment

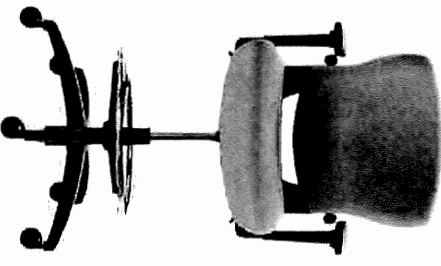
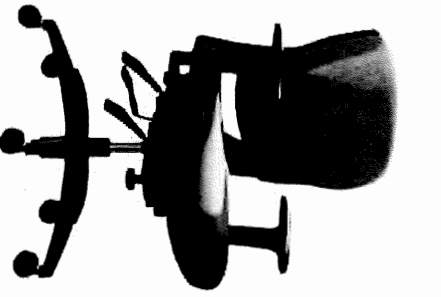
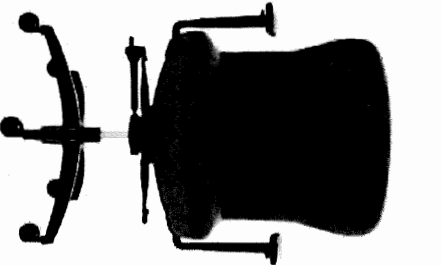
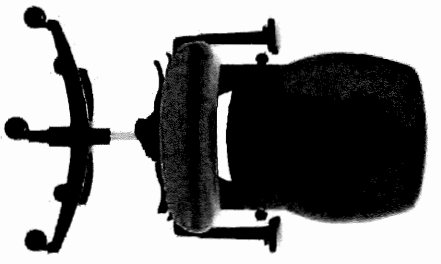
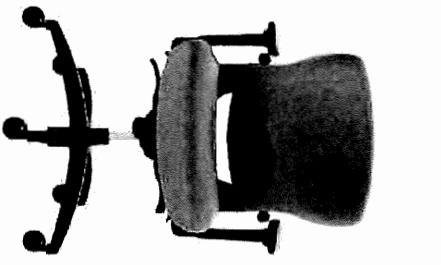

- Lumbar height adjustment up and down : includes the integrated lumbar support mechanism. It is to avoid continuous discomforting to the shape of the back
- Arm height soft mechanism armrests with adjust over a range of lumbar allowing users to find a natural position and reduce discomfort in the upper shoulders and neck
- Arm width adjustable adjustment range of 7 inches in width and 1.11 inches in depth posture users to position arm to suit individual back types and preferences

- Seat height that includes adjustable height of 17 and 18 inches allowing a choice position, seat height to suit personal size and preferences
- 180° rotation to allow side rotation adjustment either the chair's tilt mechanism to prevent a user's weight and pressure
- Seat depth : 11 inch depth (11.5 inch posture) seat to suit the chair's back posture process behind the knees and improving circulation and comfort

- Tilt so that the back tilt angle is available for the user to adjust the back posture appropriate posture for the user's back posture
- Max. tilt angle : 180° tilt angle to suit the user's back posture
- Tilt angle : 180° tilt angle to suit the user's back posture
- Tilt angle : 180° tilt angle to suit the user's back posture

teknion

TECHNOLOGY. DESIGN. COMFORT.

TECHNOLOGY. DESIGN. COMFORT.
TECHNOLOGY. DESIGN. COMFORT.
TECHNOLOGY. DESIGN. COMFORT.
TECHNOLOGY. DESIGN. COMFORT.
TECHNOLOGY. DESIGN. COMFORT.

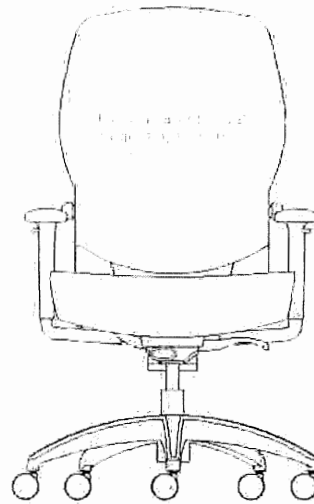

TECHNOLOGY. DESIGN. COMFORT.
TECHNOLOGY. DESIGN. COMFORT.
TECHNOLOGY. DESIGN. COMFORT.
TECHNOLOGY. DESIGN. COMFORT.
TECHNOLOGY. DESIGN. COMFORT.

www.teknion.com

IN CANADA
1170 Elton Road
Toronto, Ontario
M1H 2J5 Canada
Tel 800 teknon
416.833.6466

IN THE USA
350 Fellowship Road
Mt Laurel, New Jersey
08054 USA
Tel 877 teknon
877.835.6466

OTHER OFFICES LOCATED IN
Europe, South and Central America
Middle East, Asia and Russia
For regional contact information
go to www.teknion.com

CANADA (81) 10-17
©Teknion 2017
®, ™ trade marks of Teknion
Corporation and/or its subsidiaries or
licensed to it. Patents may be pending

Brochure Design: Vanderbyl Design
Printed in Canada BR-110-001125

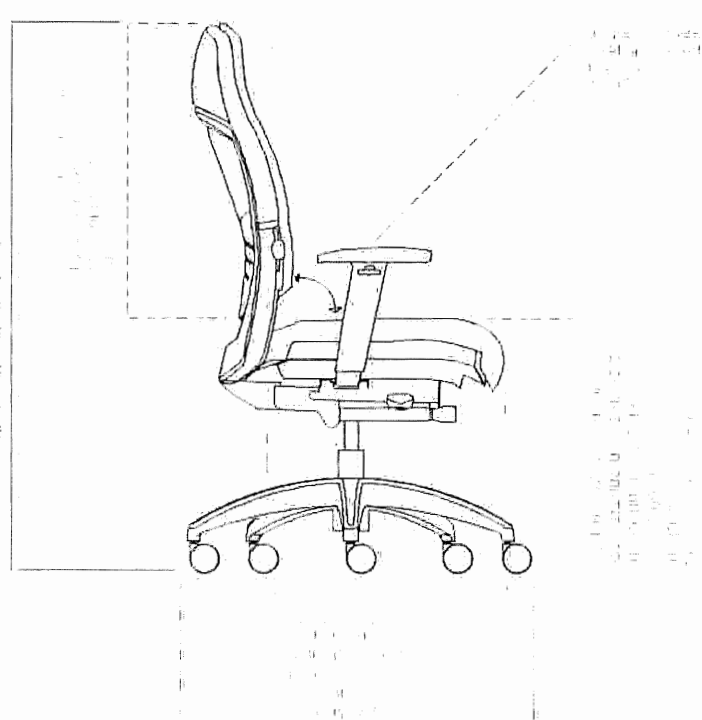

TECHNOLOGY. DESIGN. COMFORT.
TECHNOLOGY. DESIGN. COMFORT.
TECHNOLOGY. DESIGN. COMFORT.
TECHNOLOGY. DESIGN. COMFORT.
TECHNOLOGY. DESIGN. COMFORT.

TECHNOLOGY. DESIGN. COMFORT.
TECHNOLOGY. DESIGN. COMFORT.
TECHNOLOGY. DESIGN. COMFORT.
TECHNOLOGY. DESIGN. COMFORT.
TECHNOLOGY. DESIGN. COMFORT.

TECHNOLOGY. DESIGN. COMFORT.
TECHNOLOGY. DESIGN. COMFORT.
TECHNOLOGY. DESIGN. COMFORT.
TECHNOLOGY. DESIGN. COMFORT.
TECHNOLOGY. DESIGN. COMFORT.

work chairs

savera overview

Savera, classic form with comfort and performance at an exceptionally affordable price.

- Savera Chairs have been designed and tested for users weighing up to 275 lbs (Swivel Tilt Task and Stool), 300 lbs (Synchro-tilt + Multi-tilt Task), 350 lbs (Guest) and 400 lbs (Savera XL)
- Savera Chairs are equipped with casters intended for use on carpeted surfaces. Use of these casters on hard surfaces could result in unexpected rolling and tipping. Casters designed for use on hard surfaces are available. If in doubt, see your dealer for appropriate selection
- Task Chair with Synchro-Tilt shown. Swivel-Tilt mechanism and Multi-Tilt Mechanism also available

98

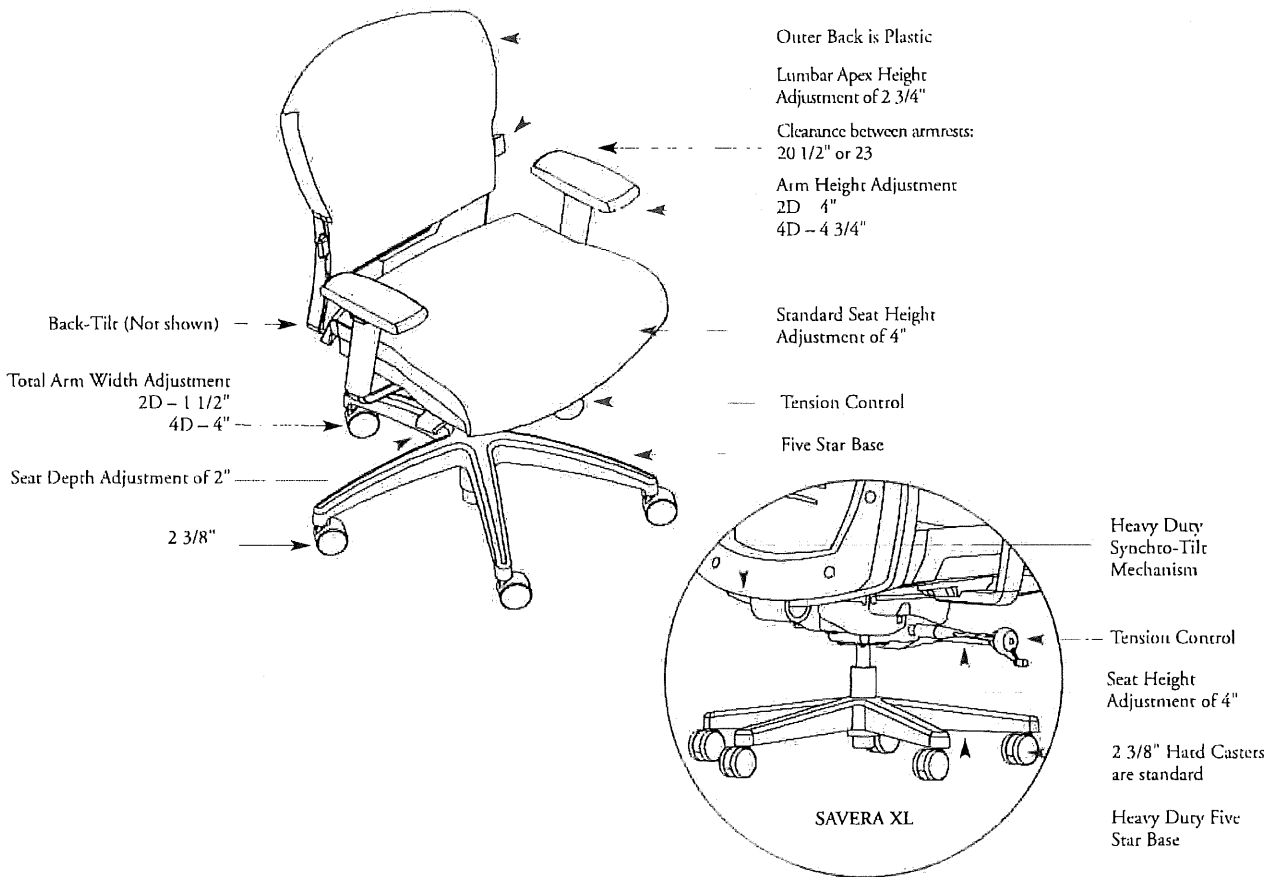

Statement of Line

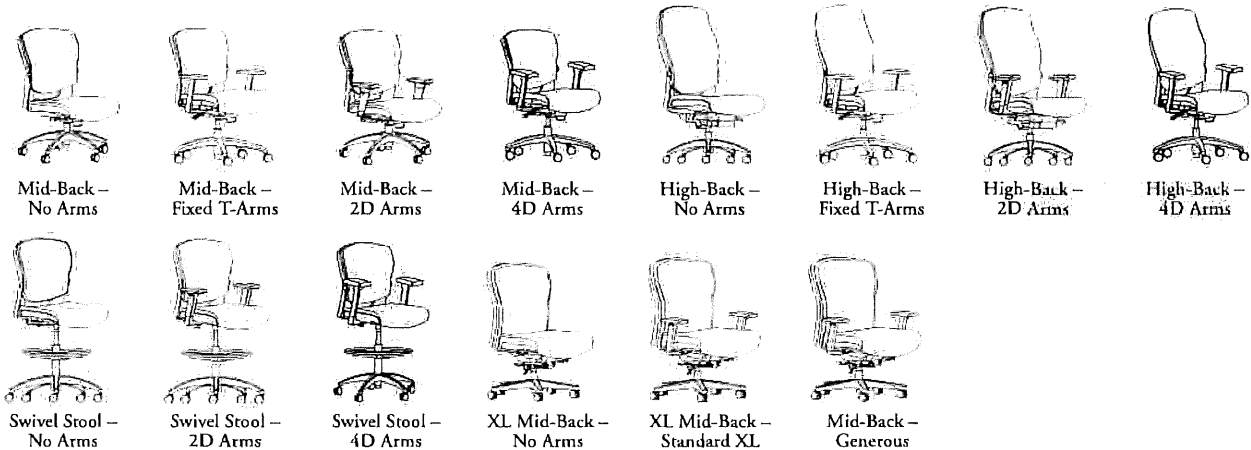

savera dimensions & material requirements

Dimensions

For Conversion to Metric, multiply dimension by 25.4

WEIGHT	
General Use/Synchro-Tilt Task	40 lbs
Multi-Tilt Task	67 lbs
Stool	41 lbs
Executive/XL	64 lbs

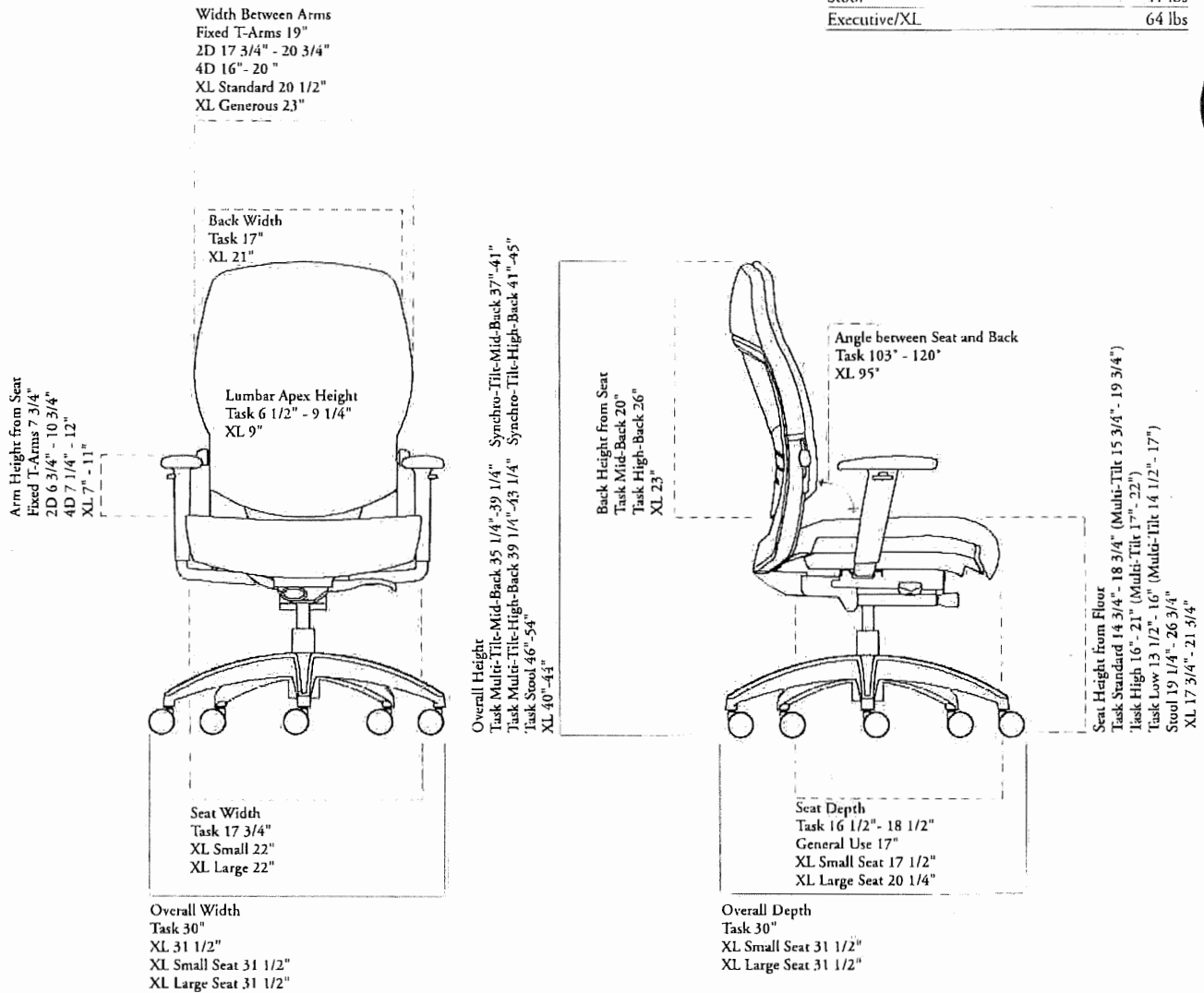

COM/COL Material Requirement

More yardage may be required depending upon the upholstery pattern, repeat, directionality and pattern matching. Leather yield varies from 60-80% and may be affected by the quality of the COL, including location and quantity of blemishes, size and shape of hide. The size of the sewing pattern and the number of units ordered may also impact yield. Always round-up to the next hide.

	SINGLE UPHOLSTERED		DUAL UPHOLSTERED - SEAT		DUAL UPHOLSTERED - BACK	
	COM [yards]	COL [sq. ft]	COM [yards]	COL [sq. ft]	COM [yards]	COL [sq. ft]
Mid-Back	1	9	1	6	3/4	4
Mid-Back (XL)	1 1/2	19 1/2	1	10 1/2	1	9 1/4
High-Back	1	11 1/2	1	8	1	7 1/2

work chairs

savera arm adjustment features & instructions

ARM WIDTH ADJUSTMENT

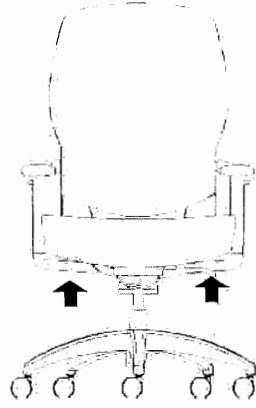
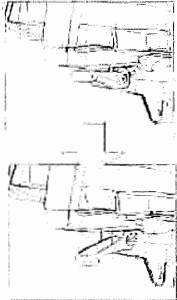

To adjust the arm width on Savera Synchro-Tilt, Multi-Tilt, Swivel-Tilt & Stool, push the lever down and slide the arm to the desired position. Push the lever up to lock the arm in place.

Savera XL arms are fixed prior to shipping in either standard or generous position.

100

ARM HEIGHT ADJUSTMENT

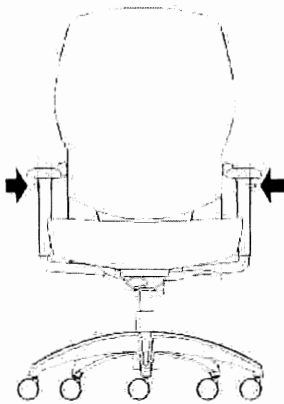

2D ARMS:

To adjust the arm height, lift the small button on the outside of either arm to raise or lower it to the desired position.

ARM HEIGHT ADJUSTMENT

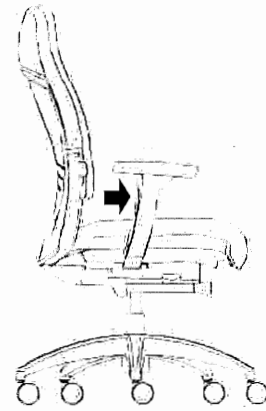
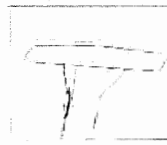

4D ARMS:

To adjust the arm height, press the button located behind either arm to raise or lower it to the desired position. Release the button to lock in place.

4D ARM PIVOT ADJUSTMENT

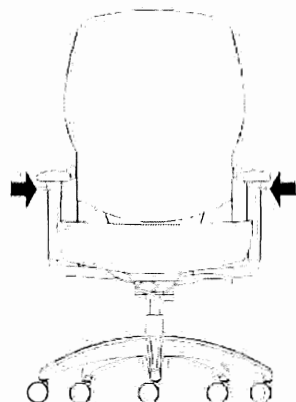
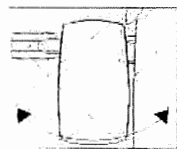

To pivot the armrest, grasp the arm cap, rotate inward or outward and release at the desired position. Not available on Savera XL.

4D ARM SLIDER ADJUSTMENT

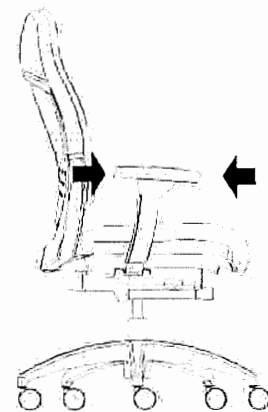
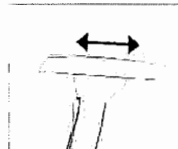

To adjust the arm cap depth position, grasp the arm cap and firmly slide forward or backward to the desired position.

work chairs

savera XL adjustment features & instructions

BACK TILT ADJUSTMENT

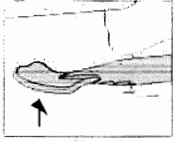

SYNCHRO-TILT XL:

The back tilt adjustment paddle is located underneath the seat on the left side. The back tilt adjustment provides the ability to lock the back into four different positions or leave in free flow.

To tilt the chair, sit in the chair and unlock the paddle by pulling it up, which will release the back to free flow. To lock the desired position, push the paddle down and the back will lock.

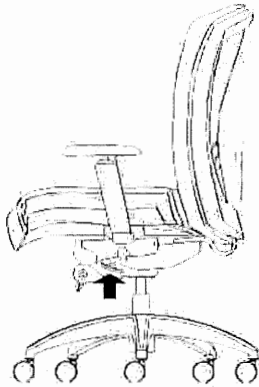

TENSION CONTROL

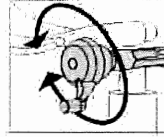

SYNCHRO-TILT XL:

The tension-adjustment wheel is located underneath the seat on the right side.

Leaning back with the back tilt adjustment paddle in the up position, determine if the resistance of the chair is comfortable. If the resistance is too stiff, turn the tension adjustment wheel counter-clockwise. If the chair back does not provide enough resistance, turn the wheel clockwise.

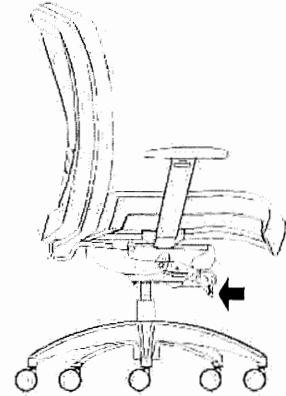

SEAT HEIGHT ADJUSTMENT

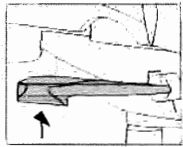

The seat height-adjustment paddle for Savera Synchro-Tilt, Swivel-Tilt & XL is located underneath the seat on the right side.

To raise the chair, lift the paddle up, while lifting your weight from the seat, until you reach the desired height, then release. To lower the chair, lift the paddle up, allowing your weight to push the seat down until you reach the desired height, then release.

The seat height-adjustment paddle for Savera Stool functions the same but the paddle is located on the left side.

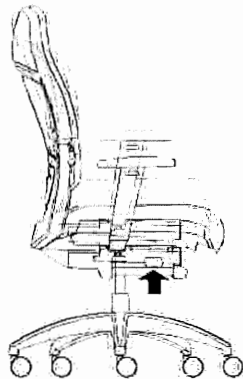

See "Savera arm adjustment features & instructions" page at the beginning of this section for arm details.

savera multi-tilt adjustment features & instructions

BACK TILT ADJUSTMENT

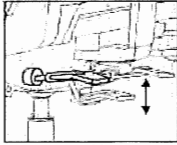

The Tilt control lever is on the right-hand side and is located at the farther back position.

To lock the back, lean back to the desired angle and firmly push the lever down to engage it. To unlock and free-float, firmly pull up the lever to the horizontal position.

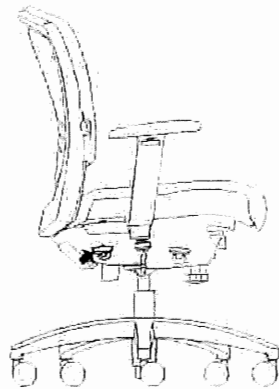

TENSION CONTROL

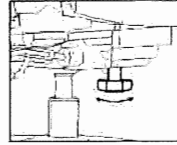

The tension adjustment knob for the multi-tilt is located in the middle, directly under the front of the seat. Turning the knob counter-clockwise will increase the tension and clockwise will decrease the tension.

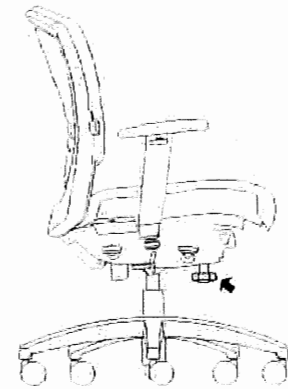

103

LUMBAR HEIGHT ADJUSTMENT

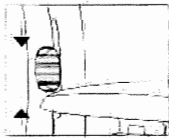

The lumbar height-adjustment levers for Savera Synchro-Tilt, Multi-Tilt, Swivel-Tilt & Stool are found at the sides of the chair. Pull levers up or down to the desired position.

Savera XL does not have lumbar height adjustment.

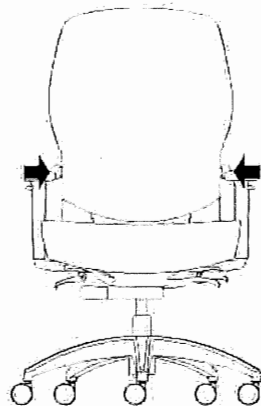

SEAT HEIGHT ADJUSTMENT

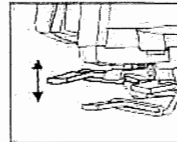

The seat height adjustment paddle on the Multi-Tilt is located on the right-hand side, underneath the arm post.

To raise the chair, lift the paddle up, while lifting your weight from the seat, until you reach the desired height, then release. To lower the chair, lift the paddle up, allowing your weight to push the seat down until you reach the desired height, then release.

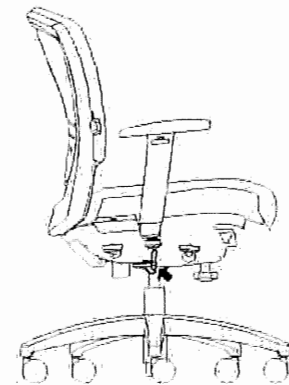

SEAT DEPTH ADJUSTMENT

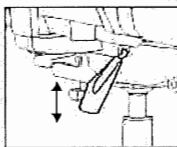

The paddle is located on the left-hand side, near the back. To adjust the seat depth, lift lever up. Simultaneously lift your weight from the seat while sliding the seat forward or backward. Release the lever to lock the seat in place.

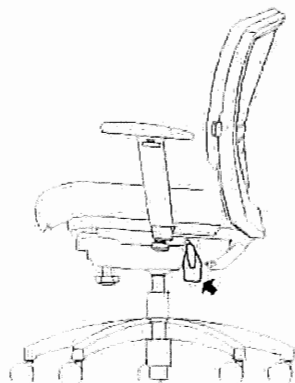

SEAT ANGLE ADJUSTMENT



The Forward-Tilt knob is located closest to the front. Rotate it forward and rearward to adjust the seat angle incline.

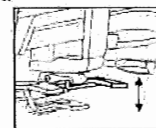

The seat angle may be infinitely adjusted when the paddle is in the horizontal position. Firmly push the lever down to lock the seat angle and pull up to the horizontal position to allow freefloating.

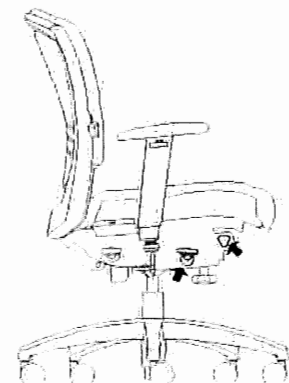

savera swivel-tilt adjustment features & instructions

BACK TILT ADJUSTMENT

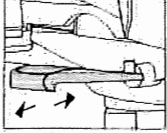

SWIVEL-TILT TASK:

The back-tilt control lever is located on the right near the front. To tilt the chair, sit in the chair and pull the handle outward. Leaving the handle in this position, the chair is now in free flow mode and can reach any position between upright and fully reclining. To lock (upper position only), bring chair to upright position and push the handle in.

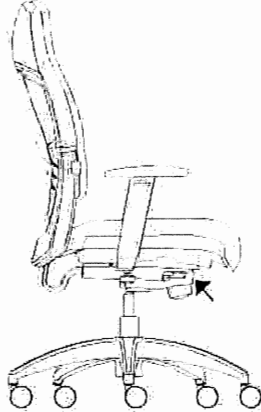

TENSION CONTROL

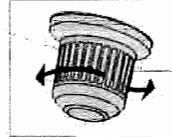

SWIVEL-TILT TASK:

The tension-adjustment knob for the swivel-tilt is located in the middle directly under the seat. Turning the knob will increase or decrease tension.

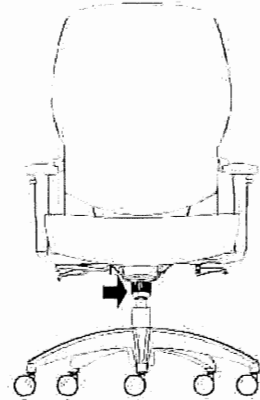

104

LUMBAR HEIGHT ADJUSTMENT

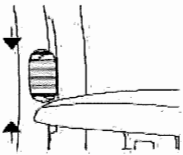

The lumbar height-adjustment levers for Savera Synchro-Tilt, Multi-Tilt, Swivel-Tilt & Stool are found at both sides of the chair. Pull both levers up or down to the desired position.

Savera XL does not have lumbar height adjustment.

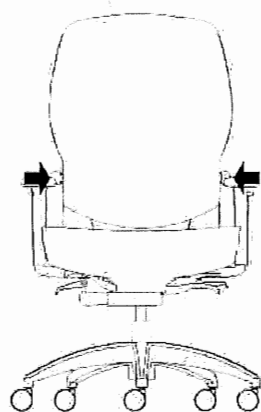

SEAT HEIGHT ADJUSTMENT

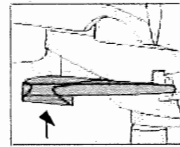

The seat height-adjustment paddle for Savera Synchro-Tilt, Swivel-Tilt & XL is located underneath the seat on the right side.

To raise the chair, lift the paddle up, while lifting your weight from the seat, until you reach the desired height, then release. To lower the chair, lift the paddle up, allowing your weight to push the seat down until you reach the desired height, then release.

The seat height-adjustment paddle for Savera Stool functions the same but the paddle is located on the left side.

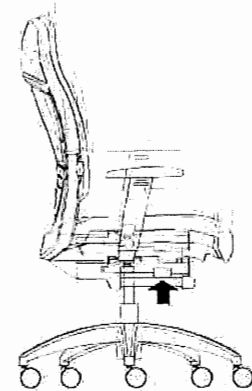

SEAT DEPTH ADJUSTMENT

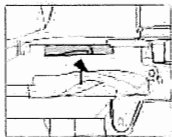

SWIVEL-TILT & SYNCHRO-TILT-TASK:

The lever is located on the left-hand side, near the front. To adjust the seat depth, lift lever up. Simultaneously lift your weight from the seat while sliding the seat forward or backward. Release the lever to lock the seat in place.

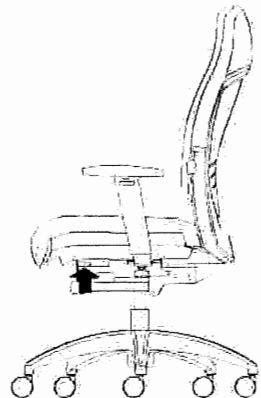

See "Savera arm adjustment features & instructions" page at the beginning of this section for arm details.

savera swivel-stool adjustment features & instructions

STOOL SEAT HEIGHT

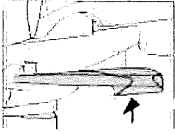

To raise the chair, lift the paddle up while lifting your weight from the seat until you reach the desired level and then release to lock in place. To lower the chair, lift the paddle up allowing your weight to push the seat down to the desired level and then release to lock in place.

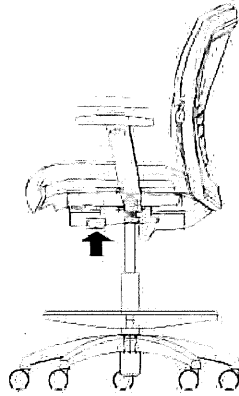

STOOL FOOT RING HEIGHT



To raise or lower the stool's foot ring, turn the foot ring's knob counter clockwise to release the foot ring and adjust the ring until you reach the desired level. Turn the knob clockwise to lock in place.

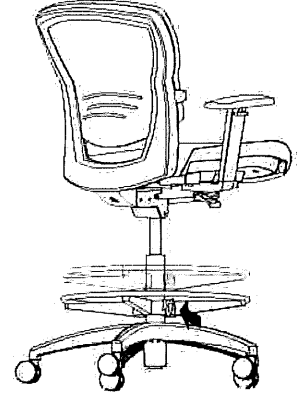

105

LUMBAR HEIGHT ADJUSTMENT

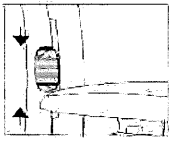

The lumbar height-adjustment levers for Savera Synchro-Tilt, Swivel-Tilt & Stool are found at the sides of the chair. Pull levers up or down to the desired position.

Savera XL does not have lumbar height adjustment.

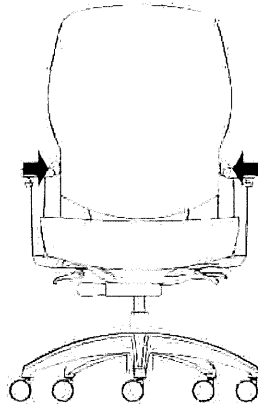

See "Savera arm adjustment features & instructions" page at the beginning of this section for arm details.

FEATURES

- Standard pneumatic cylinder provides height adjustment of 4"
- Seat depth adjustment of 2"
- Lumbar height adjustment of 2 3/4"
- Allows for independent adjustment of the back angle and seat tilt. Includes forward seat tilt and lock and infinite position seat tilt lock
- Frame, five star base and outer back are plastic
- Centre-tilt action
- Tension control
- Hard casters are standard and are well suited for soft flooring such as carpeting
- Soft casters are available for use on hard flooring, such as wood, concrete, or tile

NOTES

Single Upholstered: The same fabric is applied to the seat and inside back.
 Not all configurations are available as Xpress. Please see Xpress catalogue and/or specification software for details.
 Seat depth adjustment is included as a standard feature.

**NSAM
Savera Multi-Tilt Task Chair**

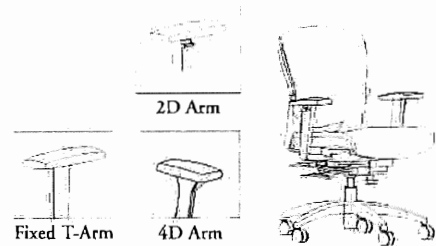

PRODUCT OPTIONS

Size	Mechanism Style	Arm Style	Upholstery Back Style	Back Upholstery Finish	Cylinder Style	Base Finish	Casters/Glides (Optional)	Assembled
F Mid-Back	1 Standard	N No Arms	P Single Upholstered	Fabric	1 Standard - 4" range 2 Higher (taller) - 5" range 3 Lower (shorter) - 3" range	E Ebony	A Casters, Hard B Casters, Soft C Glides, Hard C Glides, Soft	- Not Fully Assembled
H High-Back		F Fixed T-Arm		Seat Upholstery Finish				
	W Width & Height-Adjustable T-Arms	Fabric						
		Q 4D Width, Height and Depth pivot arm						

SAMPLE ORDER CODE

NSAM F	1	N	P	L207	1	E	A	F
---------------	----------	----------	----------	-------------	----------	----------	----------	----------

DESCRIPTION

PRICE

DESCRIPTION	PRICE									
	Grade 1	COM/ Grade 2	COL/ Grade 3	Grade 4	Grade 5	Grade 6	Grade 7	Grade 8	Grade 9	Grade 10
MID-BACK (F)										
No Arms	771	799	828	858	885	914	943	972	1002	1101
Fixed T-Arms	867	896	924	953	981	1010	1039	1068	1098	1197
4D Width-, Height- & Depth Pivot Arms	928	956	984	1013	1041	1071	1100	1129	1158	1258
2D Height & Width-Adjustable T-Arms	896	924	953	982	1010	1039	1068	1098	1127	1226
MID-BACK (F) (Continued)	Leather 1A	Leather 1B	Leather 1C	Leather 1D						
No Arms	976	1005	1094	1124						
Fixed T-Arms	1072	1101	1190	1220						
4D Width-, Height- & Depth Pivot Arms	1133	1162	1251	1280						
2D Height & Width-Adjustable T-Arms	1102	1131	1220	1249						
HIGH-BACK (H)										
No Arms	796	825	852	882	911	940	969	998	1028	1127
Fixed T-Arms	892	920	948	978	1007	1036	1065	1094	1124	1223
4D Width-, Height- & Depth Pivot Arms	952	981	1009	1038	1067	1097	1126	1155	1183	1282
2D Height & Width-Adjustable T-Arms	920	950	978	1007	1036	1065	1094	1124	1153	1252
HIGH-BACK (H) (Continued)	Leather LA	Leather LB	Leather LC	Leather LD						
No Arms	1040	1077	1192	1230						
Fixed T-Arms	1136	1174	1289	1326						
4D Width-, Height- & Depth Pivot Arms	1197	1235	1350	1387						
2D Height & Width-Adjustable T-Arms	1166	1204	1319	1356						
If Soft Casters (A) are specified	add 20									
If Hard Glides (B) are specified	add 20									
If Soft Glides (C) are specified	add 31									
			If Fully Assembled (F) is specified	add 4						

work chairs

NSAMJ Savera Multi-Tilt Task Chair (CAL-133)

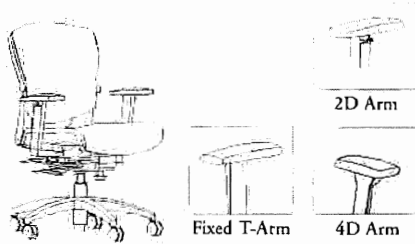

FEATURES

- Standard pneumatic cylinder provides height adjustment of 4"
- Seat depth adjustment of 2"
- Lumbar height adjustment of 2 3/4"
- Allows for independent adjustment of the back angle and seat tilt. Includes forward seat tilt and lock and infinite position seat tilt lock
- Frame includes Five-Star base in Polished Aluminum
- Centre-tilt action
- Tension control
- Hard casters are standard and are well suited for soft flooring such as carpeting
- Soft casters are available for use on hard flooring, such as wood, concrete, or tile

NOTES

Single Upholstered: The same fabric is applied to the seat and inside back.
Seat depth adjustment is included as a standard feature.

PRODUCT OPTIONS

Size	Mechanism Style	Arm Style	Upholstery Back Style	Fabric Seat	Cylinder Style	Base Finish	Casters/Glides (Optional)	Assembled
F Mid-Back H High-Back	1 Standard	N No Arms F Fixed T-Arm W Width & Height-Adjustable T-Arms Q 4D Width, Height and Depth pivot arm	P Single Upholstered	Fabric	1 Standard - 4" range 2 Higher (taller) - 5" range 3 Lower (shorter) - 3" range	C9 Polished Aluminum	A Casters, Hard B Casters, Soft C Glides, Hard C Glides, Soft	F Fully Assembled Not Fully Assembled

SAMPLE ORDER CODE

NSAMJ F	1	N	P	L207	1	C9	A	F
----------------	----------	----------	----------	-------------	----------	-----------	----------	----------

DESCRIPTION

PRICE

	Grade 1	Grade 2	Grade 3
MID-BACK (F)			
No Arms	1013	1040	1069
Fixed T-Arms	1110	1136	1165
4D Width-, Height- & Depth Pivot Arms	1167	1197	1226
2D Height & Width-Adjustable T-Arms	1136	1165	1194
HIGH-BACK (H)			
No Arms	1037	1066	1094
Fixed T-Arms	1133	1162	1190
4D Width-, Height- & Depth Pivot Arms	1193	1223	1251
2D Height & Width-Adjustable T-Arms	1162	1191	1219

If Soft Casters (A) are specified	add 20
If Hard Glides (B) are specified	add 20
If Soft Glides (C) are specified	add 31
If Fully Assembled (F) is specified	add 4

CAL-TB133 – flammability test procedure established by the State of California for seating furniture that is used in public occupancies.

TEKNION LIMITED LIFETIME WARRANTY

Teknion will, at no cost to the original purchaser and for as long as the original purchaser owns a Teknion product, repair or replace with a comparable product, at Teknion's option, any part or product sold after January 1, 1995, which fails as a result of a defect in its design, materials or workmanship. For all purposes of this warranty the term "purchaser" is defined as the entity or individual acquiring a new Teknion product as the initial purchaser thereof either from Teknion or an authorized Teknion Dealer.

Exceptions to this warranty include:

- Teknion warrants its Wood Casegoods products to be free from defects in material and workmanship for a period of 10 years, of single-shift service, from the date of delivery;
- Task Lights and grommets, which are warranted for one year from the date of delivery;
- Teknion fabrics and wood veneers, which are warranted for five years from the date of delivery;
- Complements products (excluding Livello, QuickShift, Complements and hiSpace Height-Adjustable tables) are warranted for a period of five years from the date of delivery;
- Lighting products (excluding Sanna, which is warranted for five years from the date of delivery) are warranted for one year from the date of delivery;
- Electrical components, which are warranted for 10 years from the date of delivery;
- Moving parts, which include glides, slides, casters, user-adjustable worksurface mechanisms, arms, and bases which are warranted for five years from the date of delivery, except for hiSpace Height-Adjustable mechanisms which are warranted for two years from date of delivery;
- Teknion warrants its seating products based on a single shift (40 hour week). Usage beyond a single shift (40 hour week) will result in a reduction of the warranty in proportion to the increased usage;
- Seating mechanisms for all seating products, unless otherwise stated, are warranted for 10 years of single shift (40 hour week) usage from date of delivery;
- Pneumatic cylinders for all seating products, unless otherwise stated, are warranted for 10 years of single shift (40 hour week) usage from date of delivery;
- Stacking Chairs and related accessories are warranted for five years from the date of delivery;
- Connexion™, Savera®XL and Variable® chairs are warranted based on multi-shift usage (24 hours per day, 7 days a week) as follows:
–Free from defects in material and workmanship for a period of three years –Seating Mechanism and pneumatic cylinders: three years –Moving parts, fabric and foam: two years; For single shift use (40 hour week), Connexion is warranted for 10 years;
- Altos® and Optos™ Full-Height Wall Systems which are warranted for 10 years from the date of delivery;
- Focus™ Full-Height Wall Systems which are warranted for 10 years from the date of delivery;
- The Routes™ flooring system which is warranted for 10 years from the date of delivery;
- Teknion HPL Whiteboard for Thesis Flip Top Table is warranted for a period of 3 years, of single-shift service, from the date of delivery.

This warranty does not include:

- Customer's Own Material or finishes applied to Teknion products (which include graded-in fabrics, which are treated by Teknion as a Customer's Own Material);
- Natural Wood Veneer which is a natural material and will have shade differences between veneer sheets, which will be more apparent between differing lots and fading on wood veneers that can be caused by exposure to U.V. rays/sunlight;
- Wood color, grain and stain acceptance which may occur due to the natural elements of wood;
- Marble, which is a natural product. Marble's soft and porous density makes it more vulnerable to damage and chipping;
- Ballast and light bulbs;
- Products which have been modified or which have not been installed or used according to Teknion's application and installation guidelines or warnings;
- Products that must be replaced due to normal wear and tear, negligence, abuse, accident or shipping damage;
- Products used for rental purposes.

In no event shall Teknion be liable in either tort or contract for any loss or direct, special, incidental, consequential or exemplary damages.

This warranty is the Customer's sole remedy for product defect. Teknion makes no warranties, including the express or implied warranties of merchantability and fitness for a particular purpose, other than the express warranties contained herein.

07/16

teknion

4U

4U

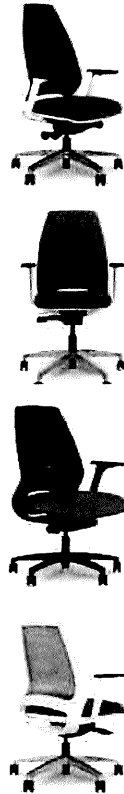

TASK | CONFERENCE

- task and conference applications
- control options: basic body balance and enhanced body balance
- four way stretch mesh mid back
- welded midback and upholstered mid and high back options
- available in black or white frame
- full range of ergonomic options
- adjustable lumbar support available on all models

via
SEATING

high back upholstered - 775/776

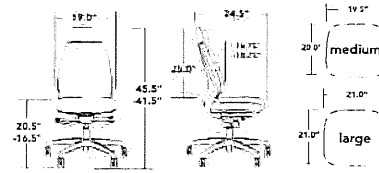

mid back upholstered - 770/771

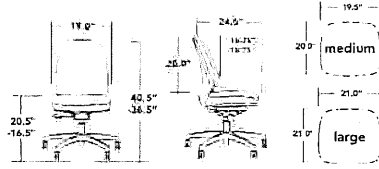

mid back mesh - 780/781

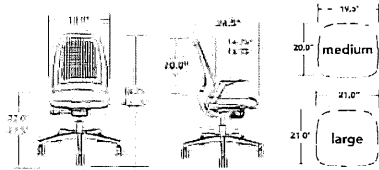

mid back groove - 785/786

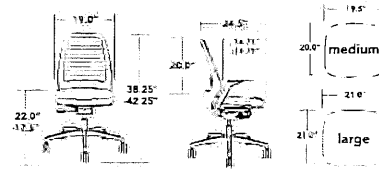

mesh colors

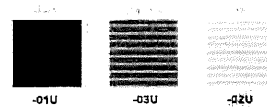

groove colors (welded fabric)

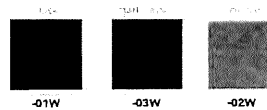

controls



-06C
basic
body balance
control

use for task | conference seating
1. seat height adjustable
2. back height adjustment (this feature is not available on all models)
note: this control is not available on all models
weight capacity: 330 lb

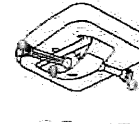

-08C
enhanced
body balance
control

use for task | conference seating
1. seat height adjustable
2. back height adjustment (this feature is not available on all models)
note: this control is not available on all models
weight capacity: 330 lb

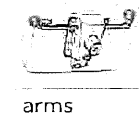

-34C
swivel and
tilt control

use for task | conference seating
1. seat height adjustable
2. back height adjustment (this feature is not available on all models)
note: this control is not available on all models
weight capacity: 330 lb

arms

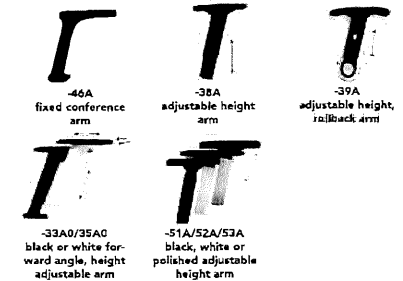

bases



addition options (full list available in price book)

- 011X 24" black polycarbonate base
- 011Y 26" polished aluminum base
- 011Z 26" brushed aluminum base
- 011A 26" black aluminum base
- B/W black or white frame
- LS4B/LS4W 4-way stretch mesh mid back
- 12SS 4-way stretch mesh mid back
- 6 4-way stretch mesh mid back
- 18S 4-way stretch mesh mid back
- 17AB 4-way stretch mesh mid back
- 16HP 4-way stretch mesh mid back
- 16SCG 4-way stretch mesh mid back
- 16GL 4-way stretch mesh mid back
- 11DR 4-way stretch mesh mid back
- 11XDR 4-way stretch mesh mid back

level **via**
SEATING

VIASEATING.COM | 800.433.6614

©2018

4U

a versatile task seating series that embodies sophisticated Italian design with full function ergonomics.



with back reclined

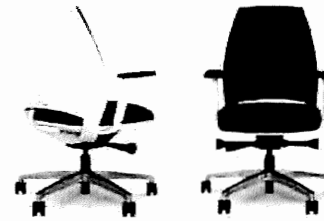

with back reclined



with back reclined (black frame)

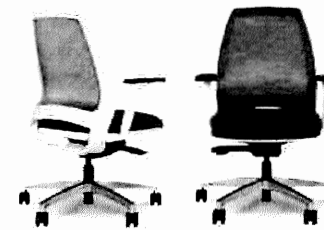

with back reclined (white frame)

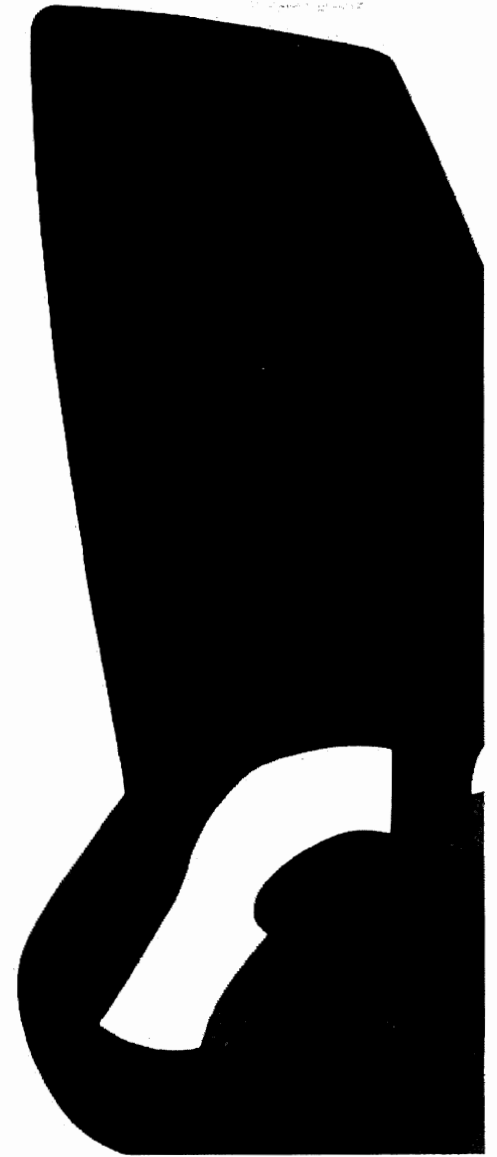

sophisticated, contemporary, high performance ergonomics

4U

TASK | CONFERENCE | DRAFTING SEATING

mesh

groove

upholstered



mid back



mid back



mid back



high back

Italian design team SI DESIGN created our newest and boldest task chair series: 4U. Designed from the bottom up around you with a shape that fits you, supports you and looks great. An incredibly versatile series with upholstered, mesh, and welded fabric options. Utilizes the latest body balance technology mechanisms. Stool kit options can also be specified for sit-to-stand or elevated work surfaces. Finishes include black and white frame options, multiple base options (including white), 3 different colors of mesh, 3 colors of welded fabric (4U Groove) and upholstered back options.

True 48-Hour Commitment

- 20/48 20 Chairs Every 48 Hours
- 10/48 10 Chairs Every 48 Hours
- ▲ CALL FOR LEAD TIME (1-800-433-6614)



Passes or exceeds all BIFMA required testing

\$625
BASE MODEL

4U - MESH MID BACK ERGONOMIC TASK SEATING

STANDARD: 780-B-66C-0A-18BB-16HP-01U-GR A

True 48-Hour Commitment

● 20/48 20 Chairs Every 48 Hours

○ 10/48 10 Chairs Every 48 Hours

▲ CALL FOR LEAD TIME (1-800-433-6614)

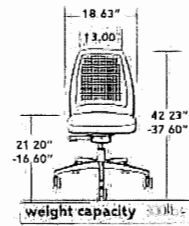

Step 1: SEATS (MODEL#)

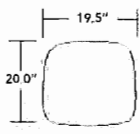

780 ● **STANDARD**
medium (B) seat

seat only: COM 0.73 yd, COL 7.5 sq. ft.

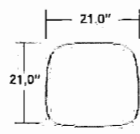
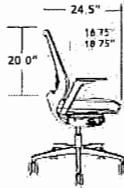

781 ● +\$77
large (C) seat

seat only: COM 1.0 yd, COL 8.0 sq. ft.

Step 2: SHELL COLORS

■ -B black ● **STANDARD**

□ -W white ● \$51

Step 2a: LUMBAR OPTIONS

■ -LS4B ● \$61

□ -LS4W ● \$61

Step 3: CONTROLS



-66C ● **STANDARD**
basic body balance

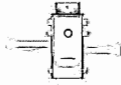

-68C ● \$117
Enhanced Body Balance



35C-11DR ● \$203
tall stool kit
35C-11XDR ● \$203
extra tall stool kit
from 10 seats only

Step 3a: SLIDER



-1255 ● \$84
Seat Slide

● **STANDARD** on 780
(66C & 68C only)

Step 4: ARMS

NO ARMS
-0A
STANDARD



forward angle, height adjustable arm
33A0 ● \$117
nylon, black
rotating 0 arm cap, black
35A0 ● \$163
nylon, white
rotating 0 arm cap, black

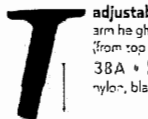

adjustable height arm height 7.0" to 9.75" (from top of seat)
38A ● \$51
nylon, black

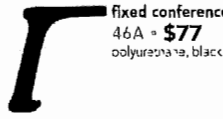

fixed conference
46A ● \$77
polyurethane, black

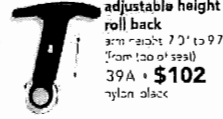

adjustable height roll back arm height 7.0" to 9.75" (from top of seat)
39A ● \$102
nylon, black



adjustable height arm height 7.5" to 11.5" (from top of seat)
51A ● \$82
nylon, black
52A ● \$107
nylon white
53A ● \$138
aluminum, polished

Step 4a: CAPS

● standard cap



-19AB ● \$31
width adjustable bracket

(N/A)



NO UPCHARGE

(N/A)



NO UPCHARGE

-19AB ● \$31
width adjustable bracket

Step 4b: BRACKETS

Step 5: BASES



-18BB ● **STANDARD**
26" black polyurethane



-18PB ● \$105
26" polished aluminum



-18BA ● \$105
26" brushed aluminum



-18WB ● \$105
26" white aluminum

Step 5a: CASTERS

SUFFIX	QS	DESCRIPTION	PRICE
-16HP	●	black carpet	STANDARD
-16SCG	●	gray hard floor	\$27
-16GL	●	glide	\$27

Step 6: MESH COLORS

NO UPCHARGE



SUFFIX QS DESCRIPTION
-01U ● black



SUFFIX QS DESCRIPTION
-02U ● stardust



SUFFIX QS DESCRIPTION
-03U ● graphite

Step 7: FABRIC GRADES

Fabric Upgrade	A	B	1/COM	2	3/COL	4	5	6	7	8
Upcharge	STANDARD	\$12	\$38	\$55	\$83	\$112	\$143	\$180	\$219	\$262

BUILD YOUR PART NUMBER





4U GROOVE - WELDED MID BACK ERGONOMIC TASK SEATING

STANDARD: 785-B-66C-0A-18BB-16HP-01W -GR A

True 48-Hour Commitment

- 20/48 20 Chairs Every 48 Hours
- 10/48 10 Chairs Every 48 Hours
- ▲ **CALL FOR LEAD TIME (1-800-433-6614)**

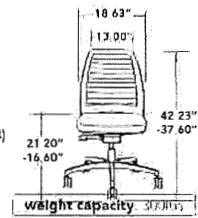

Step 1: SEATS (MODEL #)

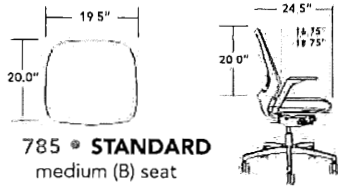

785 • STANDARD
medium (B) seat

seat only COM 0.75 yd, COL 7.5 sq ft

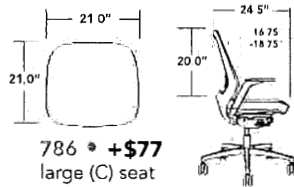

786 • +\$77
large (C) seat

seat only COM 1.0 yd, COL 8.0 sq ft

Step 2: SHELL COLORS

- -B black • **STANDARD**
- -W white • **\$51**

Step 2a: LUMBAR OPTIONS

- -L54B • **\$61**
- -L54W • **\$61**

Step 3: CONTROLS



-66C • **STANDARD**
basic body balance

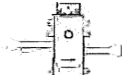

-68C • **\$117**
Enhanced Body Balance



control with front of
35C-11DR • **\$203**
tall stool kit
35C-11XDR • **\$203**
extra tall stool kit
(medium seats only)

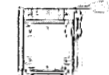

Step 3a: SLIDER

-12SS • **\$84**
Seat Slide
• **STANDARD** on 785
(66C & 68C only)

Step 4: ARMS

NO ARMS
-0A
STANDARD



forward angle, height
adjustable arm
33A0 • **\$117**
nylon, black
rotating 0 arm cap, black
35A0 • **\$163**
nylon, white
rotating 0 arm cap, black

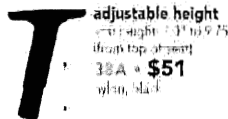

adjustable height
arm height 11\"/>

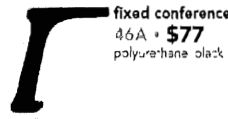

fixed conference
46A • **\$77**
polyurethane black

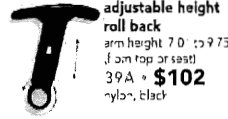

adjustable height
roll back
arm height 7.0\"/>

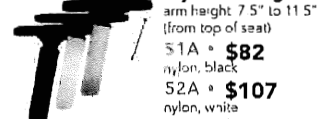

adjustable height
arm height 7.5\"/>

Step 4a: CAPS

- standard cap



(N/A)



NO UPCHARGE



NO UPCHARGE

Full Function

\$38

Step 4b: BRACKETS

-19AB • **\$31**
width adjustable bracket

(N/A)

(N/A)

-19AB • **\$31**
width adjustable bracket

Step 5: BASES



-18BB • **STANDARD**
26\"/>



-18PB • **\$105**
26\"/>



-18BA • **\$105**
26\"/>



-18WB • **\$105**
26\"/>

Step 5a: CASTERS

SUFFIX	QS	DESCRIPTION	PRICE
-16HP	●	black carpet	STANDARD
-16SCG	●	gray hard floor	\$27
-16GL	●	glide	\$27

Step 6: WELDED FABRIC COLORS

NO UPCHARGE

SUFFIX QS DESCRIPTION
-01UG ● black

SUFFIX QS DESCRIPTION
-02UG ● light grey

SUFFIX QS DESCRIPTION
-03UG ● dark grey

Step 7: FABRIC GRADES

Fabric Upgrade	A	B	1/COM	2	3/COL	4	5	6	7	8
Upcharge	STANDARD	\$12	\$38	\$55	\$83	\$112	\$143	\$180	\$219	\$262

BUILD YOUR PART NUMBER

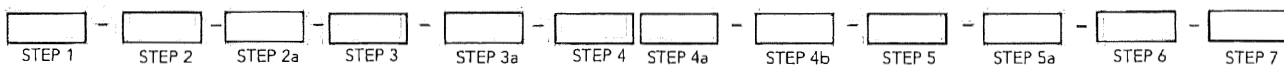



4U - UPHOLSTERED

ERGONOMIC TASK SEATING

STANDARD: 770-B-66C-0A-18BB-16HP-GR A

True 48-Hour Commitment

- 20/48 20 Chairs Every 48 Hours
- 10/48 10 Chairs Every 48 Hours
- ▲ CALL FOR LEAD TIME (1-800-433-6614)

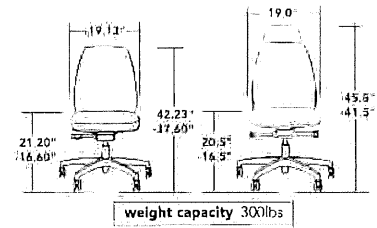

Step 1: BACKS & SEATS (MODEL#)

mid backs

high backs

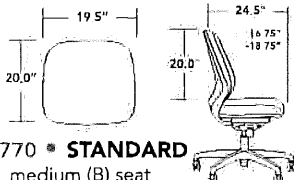

770 • STANDARD
medium (B) seat

back only: COM 1 0 yd; COL 6 5 sq ft
seat only: COM 0 75 yd; COL 7 5 sq ft

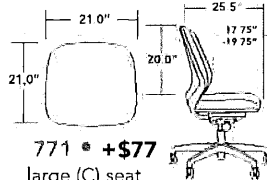

771 • +\$77
large (C) seat

back only: COM 1 0 yd; COL 6 5 sq ft
seat only: COM 1 0 yd; COL 8 0 sq ft

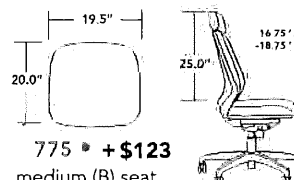

775 • +\$123
medium (B) seat

back only: COM 1 0 yd; COL 8 0 sq ft
seat only: COM 0 75 yd; COL 7 5 sq ft

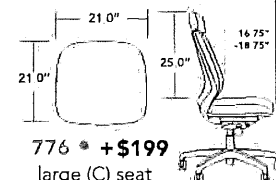

776 • +\$199
large (C) seat

back only: COM 1 0 yd; COL 8 0 sq ft
seat only: COM 1 0 yd; COL 8 0 sq ft

Step 2: SHELL COLORS

- B black • **STANDARD**
- -W white • **\$51**

Step 3: CONTROLS

- 66C • **STANDARD**
basic body balance
- 68C • **\$117**
Enhanced Body Balance
- 35C-11DR • **\$203**
tall stool kit
- 35C-11XDR • **\$203**
extra tall stool kit (medium seats only)

Step 3a: SLIDER

- 125S • **\$84**
Seat Slide
- **STANDARD** on 770, 775
(66C & 68C only)

Step 4: ARMS

NO ARMS
-0A
STANDARD

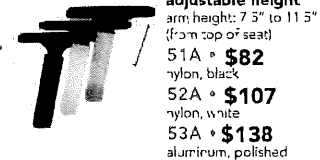
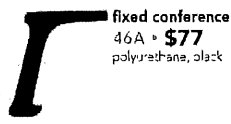
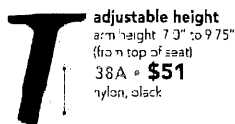
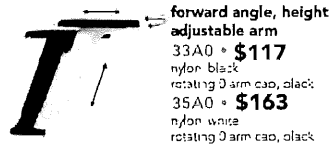

Step 4a: CAPS

- standard cap

Step 4b: BRACKETS

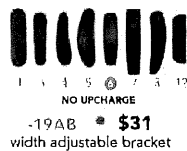

(N/A)

(N/A)

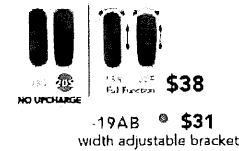
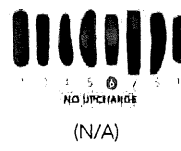

Step 5: BASES



Step 5a: CASTERS

SUFFIX	QS	DESCRIPTION	PRICE
-16HP	●	black carpet	STANDARD
-16SCG	●	gray hard floor	\$27
-16GL	●	glide	\$27

Step 6: FABRIC GRADES

Fabric Upgrade	A	B	1/COM	2	3/COL	4	5	6	7	8
Mid Back Upcharge	STANDARD	\$12	\$38	\$55	\$83	\$112	\$143	\$180	\$219	\$262
High Back Upcharge	STANDARD	\$14	\$44	\$64	\$96	\$130	\$166	\$209	\$256	\$304

BUILD YOUR PART NUMBER

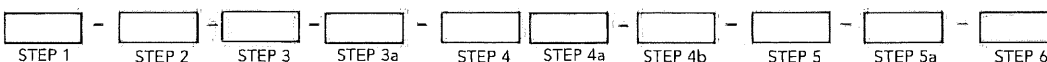

proform (mesh)

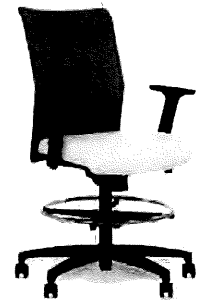
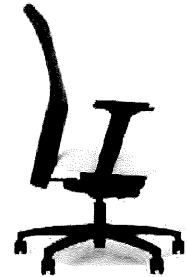
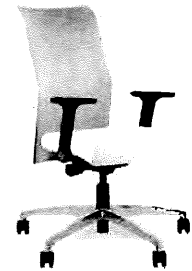
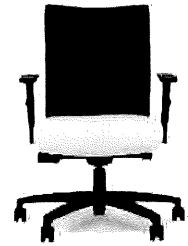

TASK | CONFERENCE | STOOL

- high and mid back options
- ratchet back height adjustments
- simple swivel tilt & full ergonomic syncro controls
- designed for management, task and conference applications
- upholstered version also available

viaTM
SEATING

proform (mesh)

high back - 152

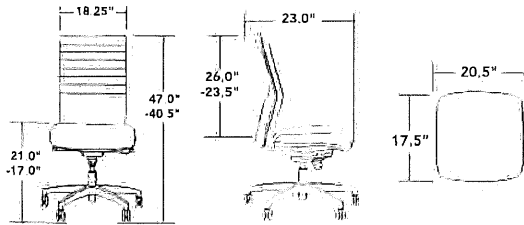

mid back - 151

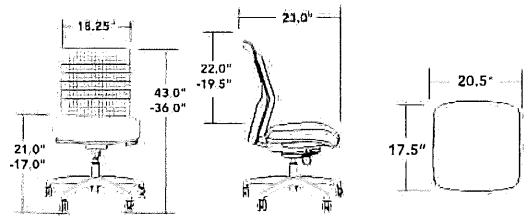

controls

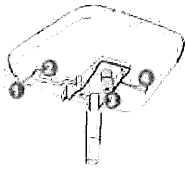

-25C/26C swivel tilt control

use for: conference seating

1. seat height adjustment
2. tilt lock
3. back/recline tension adjustment
4. seat slider on 26C (range: 2.5")

note: Seat and back tilt as a unit
weight capacity: 275 lbs

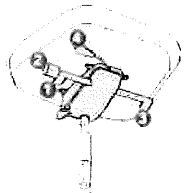

-61C/62C syncro control with Side tension adjustment

use for: task | conference seating

1. seat height adjustment
2. back/recline tension adjustment
3. tilt lock
4. seat slider on 62C (range 2.5")

note: seat and back move at 2:1 ratio
weight capacity: 300 lbs



-66C basic body balance control

use for: task | conference seating

1. seat height adjustment
2. back lock adjustment (5 position)
3. seat slider with 1" (range 2")

note: seat and back move at 3:1 ratio
weight capacity: 400 lbs

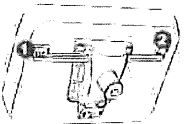

-34C swivel and tilt control

use for: drafting stools

1. seat height adjustment
2. tilt lock

note: seat angle is fixed
weight capacity: 300 lbs

mesh colors

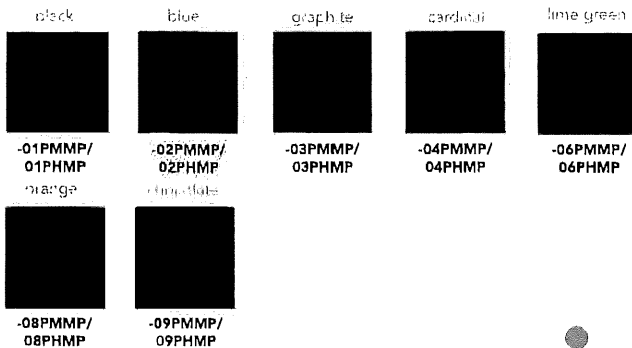

arms

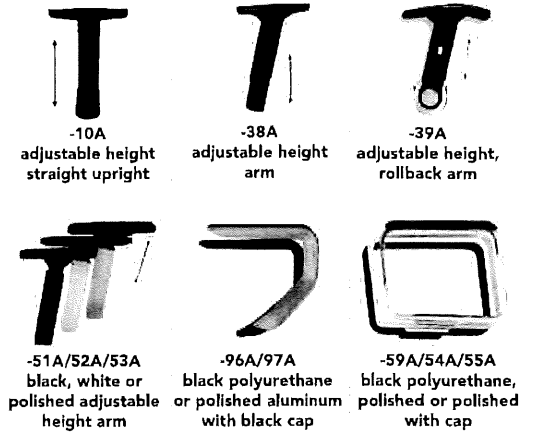

bases



addition options (full list available in price book)

SUFFIX	DESCRIPTION
-12SS	seat sling (N/A on 11DR, 11XDR)
-12	standard cap: 10A, 38A, 39A
-18S	standard cap: 51A, 52A, 53A
-17AB	width adjustment bracket: 38A, 51A, 52A, 53A
-18AB	width adjustment bracket: 10A
-21TB133T	TB133 fire rated products
-16HP	standard black carpet caster
-16SCG	gray hard floor caster
-16GL	black glides
-11DR	tall stool kit (only on -3C, N/A C seat)
-11XDR	extra tall stool kit (only on -3C, N/A C seat)
-24SB	black sled base (mid back only)
-24SC	chrome sled base (mid back only)
-11MG	metal guard (increases warranty duration)



proform (upholstered)



TASK | CONFERENCE | STOOL

- high and mid back options
- ratchet back height adjustments
- simple swivel tilt & full ergonomic syncro controls
- designed for management, task and conference applications
- mesh version also available

via[™]
SEATING

proform (upholstered)

high back
panel stitch - 162
parallel stitch - 172

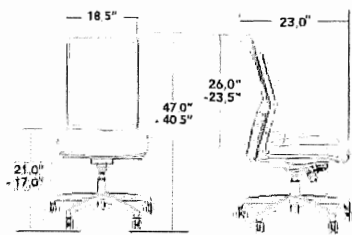

(chair shown has a panel stitch back)

mid back
panel stitch - 161
parallel stitch - 171

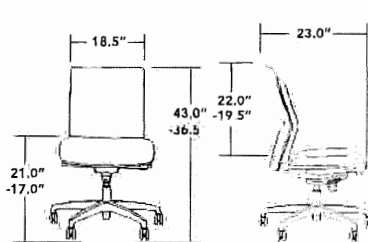

(chair shown has a panel stitch back)

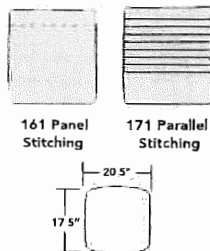
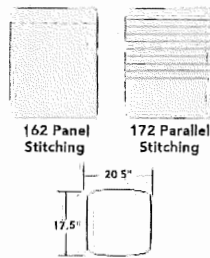

arms

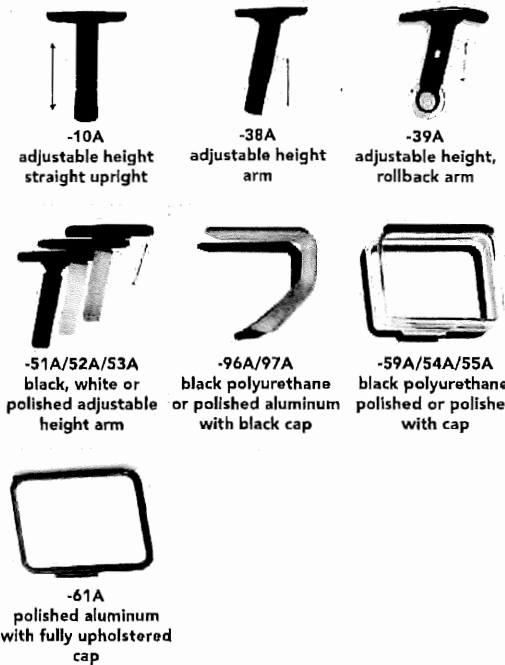

controls

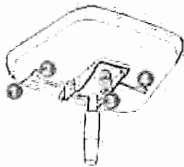

-25C/26C
swivel tilt
control

use for: conference seating

- 1 seat height adjustment
- 2 tilt lock
- 3 back/recline tension adjustment
- 4 seat slider on 26C (range: 2.5")

note: seat and back tilt as a unit
weight capacity: 275 lbs

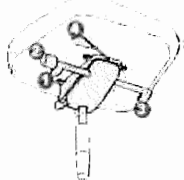

-61C/62C
syncro control
with side
tension
adjustment

use for: task | conference seating

- 1 seat height adjustment
- 2 back/recline tension adjustment
- 3 tilt lock
- 4 seat slider on 62C (range 2.5")

note: seat and back move at 2:1 ratio
weight capacity: 300 lbs



-66C
basic
body balance
control

use for: task | conference seating

- 1 seat height adjustment
- 2 back lock adjustment (5 position)
- 3 seat slider with 125% (range 2")

note: seat and back move at 3:1 ratio
weight capacity: 400 lbs

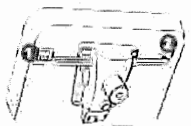

-34C
swivel and
tilt control

use for: drafting stools

- 1 seat height adjustment
- 2 tilt lock

note: seat angle is fixed
weight capacity: 300 lbs

bases

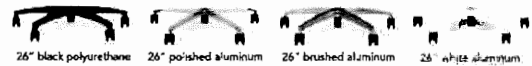

addition options (full list available in price book)

SUFFIX	DESCRIPTION
-12SS	seat slide (N/A on 11DR, 11XDR)
-12	standard cap 10A, 38A, 39A
-18S	standard cap 51A, 52A, 53A
-17AB	width adjustment bracket 51A, 52A, 53A
-18AB	width adjustment bracket 10A
-21TB133T	TB133 fire rated products
-16HP	standard black carpet caster
-16SCG	gray hard floor caster
-16GL	black glides
-11DR	tall stool kit (only on -3C, N/A C seat)
-11XDR	extra tall stool kit (only on -3C, N/A C seat)
-24SB	black sled base (mid back only)
-24SC	chrome sled base (mid back only)



PROFORM

TASK | CONFERENCE | EXECUTIVE SEATING

mesh

upholstered
panel stitch

upholstered
parallel stitch

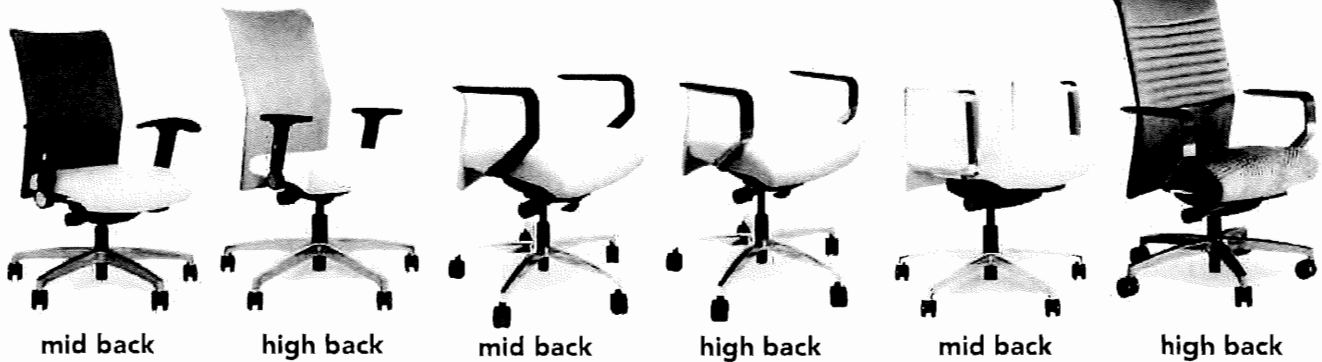

Eye the upholstered back versions of the Proform series, which offers a single, pronounced panel stitch or multiple parallel stitches. Rest back into 7 mesh colors ranging from a classic black to an eye-catching lime green crafted around a mid or high back frame. Apply a variety of arms from 6 height adjustable and full function arms and caps to 4 fixed C and loop arms including a sleek curve of polished aluminum with a black polyurethane cap. Enjoy the functionality of swivel, 6 position tilt lock, seat slide and drafting kit control atop 4 base options.

The Proform series promises durability and options while delivering on performance and comfortability. Use in task, conference and management environments.

True 48-Hour Commitment

- 20/48 20 Chairs Every 48 Hours
- 10/48 10 Chairs Every 48 Hours
- ▲ CALL FOR LEAD TIME (1-800-433-6614)



Passes or exceeds all BIFMA required testing



PROFORM - 151 MID BACK, RATCHET MESH, MEDIUM SEAT

TASK | CONFERENCE SEATING

STANDARD: 151-25C-0A-18BB-16HP-01PMMP-GR A

True 48-Hour Commitment

- 20/48 20 Chairs Every 48 Hours
- 10/48 10 Chairs Every 48 Hours
- ▲ CALL FOR LEAD TIME (1-800-433-6614)



seat only COM 75 yd. COL 7.2 sq ft
weight capacity: see controls

Step 1: CONTROLS

-25C ● STANDARD Swivel Tilt Control (weight capacity 275lbs)	-26C ● \$84 Swivel Tilt Control with Seat Slide (weight capacity 275lbs)	-61C ● \$60 Synco Control with Side Tension Adjustment (weight capacity 300lbs)	-62C ● \$144 Synco Control with Side Tension Adjustment and Seat Slide (weight capacity 300lbs)	-66C ● \$56 basic body balance (weight capacity 300lbs)	35C-11DR ● \$203 4 IP control tall stool kit	35C-11XDR ● \$203 4 IP control extra tall stool kit (weight capacity 300lbs)
					24SB ● \$255 black sled base	24SC ● \$255 chrome sled base (weight capacity 250lbs)
					-66C ● \$117 Enhanced Body Balance (weight capacity 300lbs)	-12SS ● \$84 Seat Slide (66C only)

SLEDS CHOOSE ARM CAP

Step 1a: SLIDER

Step 2: ARMS

NO ARMS -0A STANDARD	classic loop 65A ● \$118 polyurethane, black 70A ● \$201 aluminum, polished polyurethane cap, black <small>WHILE SUPPLIES LAST</small>	contemporary cantilever 96A ● \$153 polyurethane, black 97A ● \$209 aluminum, polished polyurethane cap, black	loop 59A ● \$118 polyurethane, black 54A ● \$173 aluminum, polished 55A ● \$209 aluminum, polished polyurethane cap, black
	adjustable height arm height 70" to 97.5" (from top of seat) 38A ● \$51 nylon, black	adjustable height straight upright arm height 70" to 110" (from top of seat) 10A ● \$82 nylon, black	adjustable height roll back arm height 70" to 97.5" (from top of seat) 39A ● \$102 nylon, black
			adjustable height arm height 75" to 110" (from top of seat) 51A ● \$82 nylon, black 52A ● \$107 nylon, white 53A ● \$138 aluminum, polished

Step 2a: CAPS

- standard cap

Step 2b: BRACKETS

-19AB ● \$31 width adjustable bracket	-20AB ● \$31 width adjustable bracket	(N/A)	-19AB ● \$31 width adjustable bracket
---	---	-------	---

Step 3: BASES

-18BB ● STANDARD 26" black polyurethane	-18PB ● \$105 26" polished aluminum	-18BA ● \$105 26" brushed aluminum	-18WB ● \$105 26" white aluminum
---	---	--	--

Step 3a: CASTERS

SUFFIX	QS	DESCRIPTION	PRICE
-16HP	●	black carpet	STANDARD
-16SCG	●	gray hard floor	\$27
-16GL	●	glide	\$27

Step 4: MESH COLORS

SUFFIX	QS	DESCRIPTION	SUFFIX	QS	DESCRIPTION	SUFFIX	QS	DESCRIPTION	SUFFIX	QS	DESCRIPTION
-01PMMP	●	black	-03PMMP	●	graphite	-06PMMP	▲	lime green	-09PMMP	▲	dark chocolate
-02PMMP	▲	blue	-04PMMP	▲	cardinal	-08PMMP	▲	orange			

Step 5: OPTIONS

SUFFIX	QS	DESCRIPTION	PRICE	SUFFIX	QS	DESCRIPTION	PRICE
-21TB133T	○	TB133 fire rated products	\$105	-11MG	●	mesh guard	\$26

Step 6: FABRIC GRADES

Fabric Upgrade	A	B	1/COM	2	3/COL	4	5	6	7	8
Upcharge	STANDARD	\$11	\$35	\$50	\$73	\$107	\$142	\$196	\$254	\$327

BUILD YOUR PART NUMBER

151 - - - - - - - - - - -

STEP 1 STEP 1a STEP 2 STEP 2a STEP 2b STEP 3 STEP 3a STEP 4 STEP 5 STEP 6



PROFORM - 152 HIGH BACK, RATCHET MESH, MEDIUM SEAT

TASK | CONFERENCE SEATING

STANDARD: 152-25C-0A-18BB-16HP-01PHMP-GR A

True 48-Hour Commitment

- 20/48 20 Chairs Every 48 Hours
- 10/48 10 Chairs Every 48 Hours
- ▲ CALL FOR LEAD TIME (1-800-433-6614)

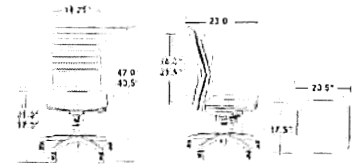

seat only COM 75 yd; COL 7 2 sq ft
weight capacity see controls

Step 1: CONTROLS

- 25C ● **STANDARD**
Swivel Tilt Control
(weight capacity 275lbs)
- 26C ● **\$84**
Swivel Tilt Control with Seat Slide
(weight capacity 275lbs)
- 61C ● **\$60**
Synchro Control with Side Tension Adjustment
(weight capacity 300lbs)

- 62C ● **\$144**
Synchro Control with Side Tension Adjustment and Seat Slide
(weight capacity 300lbs)
- 66C ● **\$56**
basic body balance
(weight capacity 300lbs)
- 66C ● **\$117**
Enhanced Body Balance
(weight capacity 300lbs)
- Swivel & tilt control
35C-11DR ● **\$203**
tall stool kit
35C-11XDR ● **\$203**
extra tall stool kit
(weight capacity 300lbs)

Step 1a: SLIDER

- 125S ● **\$84**
Seat Slide
(66C only)

Step 2: ARMS

NO ARMS
-0A
STANDARD



- classic loop
65A ● **\$118**
polyurethane, black
70A ● **\$201**
aluminum, polished
polyurethane cap, black



- contemporary cantilever
96A ● **\$153**
polyurethane, black
97A ● **\$209**
aluminum, polished
polyurethane cap, black



- loop
99A ● **\$118**
polyurethane, black
54A ● **\$173**
aluminum, polished
55A ● **\$209**
aluminum, polished
polyurethane cap, black



- adjustable height
arm height: 7'0" to 9'5"
(from top of seat)
38A ● **\$51**
nylon, black



- adjustable height
straight upright
arm height: 7'0" to 11'0"
(from top of seat)
10A ● **\$82**
nylon, black



- adjustable height
roll back
arm height: 7'0" to 9'5"
(from top of seat)
39A ● **\$102**
nylon, black



- adjustable height
arm height: 7'5" to 11'5"
(from top of seat)
51A ● **\$82**
nylon, black
52A ● **\$107**
nylon, white
53A ● **\$138**
aluminum, polished

Step 2a: CAPS

● standard cap



- NO UPCHARGE
-19AB ● **\$31**
width adjustable bracket



- NO UPCHARGE
-20AB ● **\$31**
width adjustable bracket



(N/A)

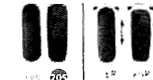

- NO UPCHARGE
-19AB ● **\$31**
width adjustable bracket

Step 2b: BRACKETS

Step 3: BASES

- 18BB ● **STANDARD**
26" black polyurethane

- 18PB ● **\$105**
26" polished aluminum

- 18BA ● **\$105**
26" brushed aluminum

- 18WB ● **\$105**
26" white aluminum

Step 3a: CASTERS

SUFFIX	QS	DESCRIPTION	PRICE
-16HP	●	black carpet	STANDARD
-16SCG	●	gray hard floor	\$27
-16GL	●	glide	\$27

Step 4: MESH COLORS

NO UPCHARGE	SUFFIX	QS	DESCRIPTION	SUFFIX	QS	DESCRIPTION	SUFFIX	QS	DESCRIPTION	SUFFIX	QS	DESCRIPTION
	-01PHMP	●	black	-03PHMP	●	graphite	-06PHMP	▲	lime green	-09PHMP	▲	dark chocolate
	-02PHMP	▲	blue	-04PHMP	▲	cardinal	-08PHMP	▲	orange			

Step 5: OPTIONS

SUFFIX	QS	DESCRIPTION	PRICE	SUFFIX	QS	DESCRIPTION	PRICE
-21TB133T	○	TB133 fire rated products	\$105	-11MG	●	mesh guard	\$26

Step 6: FABRIC GRADES

Fabric Upgrade	A	B	1/COM	2	3/COL	4	5	6	7	8
Upcharge	STANDARD	\$11	\$35	\$50	\$73	\$107	\$142	\$196	\$254	\$327

BUILD YOUR PART NUMBER

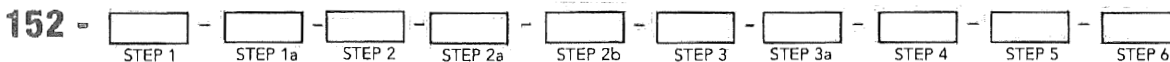



PROFORM - RATCHET UPHOLSTERED BACK, MEDIUM SEAT

TASK | CONFERENCE | EXECUTIVE SEATING

STANDARD: 161-25C-0A-18BB-16HP-GR A

True 48-Hour Commitment

● 20/48 20 Chairs Every 48 Hours

○ 10/48 10 Chairs Every 48 Hours

▲ CALL FOR LEAD TIME (1-800-433-6614)

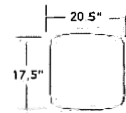

weight capacity see controls

Step 1: BACKS (MODEL #)

 panel stitch 161 • STANDARD mid back, panel stitch seat & back COM 1.75 yd, COL 20.16 sq ft	 162 • +\$55 high back, panel stitch seat & back COM 2.0 yd, COL 21.32 sq ft	 parallel stitch 171 • NO UPCHARGE mid back, parallel stitch seat & back COM 1.5 yd, COL 20.16 sq ft	 172 • +\$55 high back, parallel stitch seat & back COM 1.75 yd, COL 21.32 sq ft
--	--	--	--

Step 2: CONTROLS

 -25C • STANDARD Swivel Tilt Control (weight capacity 275lbs)	 -26C • \$84 Swivel Tilt Control with Seat Slide (weight capacity 275lbs)	 61C • \$60 Synchro Control with Tilt Tension Adjustment (weight capacity 300lbs)	 -62C • \$144 Synchro Control with Slide Tension Adjustment and Seat Slide (weight capacity 300lbs)
---	---	---	---

SLEDS (SEE REV. CAP)

Step 2a: SLIDER

 -66C • \$56 basic body balance (weight capacity 300lbs)	 35C-11DR • \$203 tall stool kit	 35C-11XDR • \$203 extra tall stool kit (weight capacity 300lbs)	 24SB • \$255 black sled base	 24SC • \$255 chrome sled base (weight capacity 250lbs)	 -12SS • \$84 Seat Slide (66C only)
--	---	--	--	---	---

Step 3: ARMS

NO ARMS -0A STANDARD	 loop 61A • choose grade aluminum, polished upholstered cap COM add -0.5 yd (17C) add -2.25 sq ft	Fabric Grade A B 1/COM 2 3/COL 4 5 6 7 8 Upcharge \$239 \$239 \$239 \$239 \$239 \$239 \$269 \$269 \$269 \$269	 classic loop 65A • \$118 polyurethane, black 70A • \$201 aluminum, polished polyurethane cap, black	 contemporary cantilever 96A • \$153 polyurethane, black 97A • \$209 aluminum, polished polyurethane cap, black	 loop 59A • \$118 polyurethane, black 54A • \$173 aluminum, polished 55A • \$209 aluminum, polished polyurethane cap, black
 adjustable height arm height: 7.0" to 9.75" (from top of seat) 38A • \$51 nylon, black	 adjustable height straight upright arm height: 7.0" to 11.0" (from top of seat) 10A • \$82 nylon, black	 adjustable height roll back arm height: 2.0" to 9.75" (from top of seat) 39A • \$102 nylon, black	 adjustable height roll back arm height: 7.5" to 11.5" (from top of seat) 51A • \$82 nylon, black 52A • \$107 nylon, white 53A • \$138 aluminum, polished		

Step 3a: CAPS

● standard cap

 NO UPCHARGE -19AB • \$31 width adjustable bracket	 NO UPCHARGE -20AB • \$31 width adjustable bracket	 NO UPCHARGE (N/A)	 NO UPCHARGE -19AB • \$31 width adjustable bracket
--	--	--------------------------	--

Step 3b: BRACKETS

Step 4: BASES

 -18BB • STANDARD 26" black polyurethane	 -18PB • \$105 26" polished aluminum	 -18BA • \$105 26" brushed aluminum	 -18WB • \$105 26" white aluminum
---	---	--	--

Step 4a: CASTERS

SUFFIX	QS	DESCRIPTION	PRICE
-16HP	●	black carpet	STANDARD
-16SCG	●	gray hard floor	\$27
-16GL	●	glide	\$27

Step 5: OPTIONS

SUFFIX	QS	DESCRIPTION	PRICE
-21TB133T	○	TB133 fire rated products	\$105

Step 6: FABRIC GRADES

Fabric Upgrade	A	B	1/COM	2	3/COL	4	5	6	7	8
Mid Back Upcharge	STANDARD	\$27	\$92	\$131	\$196	\$287	\$377	\$520	\$676	\$870
High Back Upcharge	STANDARD	\$29	\$102	\$146	\$219	\$321	\$423	\$584	\$760	\$979

BUILD YOUR PART NUMBER

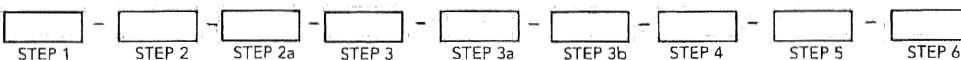

swopper

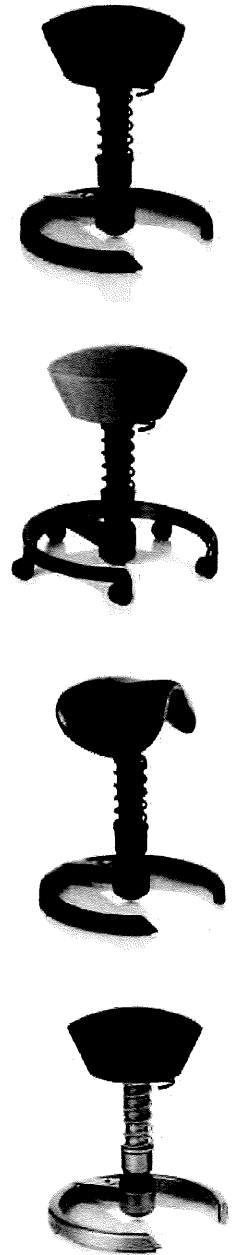

MOTION

- provides a fun and energetic sitting experience
- anthracite and titanium (select models) bases
- casters available on select models
- provides relief from back pain by improving posture
- strengthens and conditions back, abdomen and leg muscles
- pneumatic height adjustment, spring tension and lateral tensions
- 265lbs weight capacity

viaTM
SEATING

swopper

made-to-order seat - SWUS_CUSTOM
(Weight capacity 265lbs)

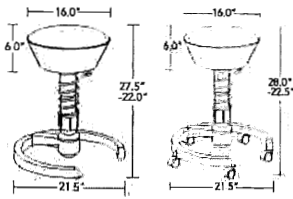

classic seat - SWUS_CLASSIC
(Weight capacity 265lbs)

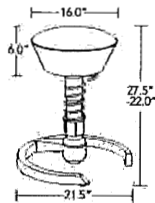

saddle seat - SWUS_SADDLE
(Weight capacity 265lbs)

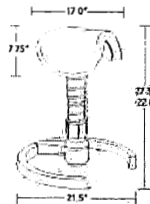

air seat - SWUS_AIR
(Weight capacity 265lbs)

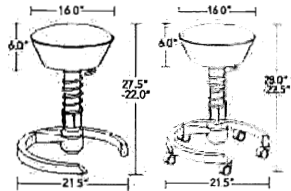

tall frame - SWUS_HIGH
(Weight capacity 265lbs)

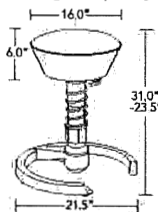

base finishes

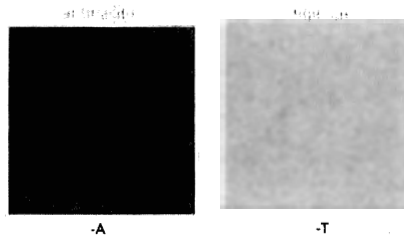

ultrasuede seat colors & springs (classic only)

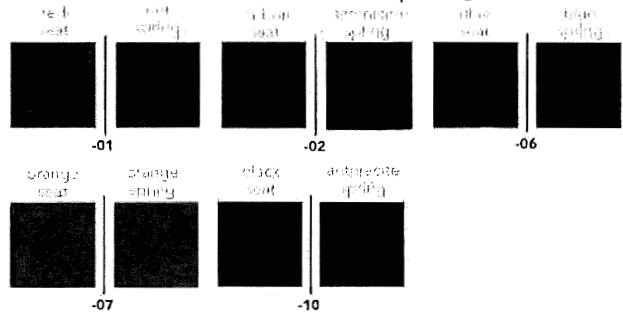

air seat colors (air only)

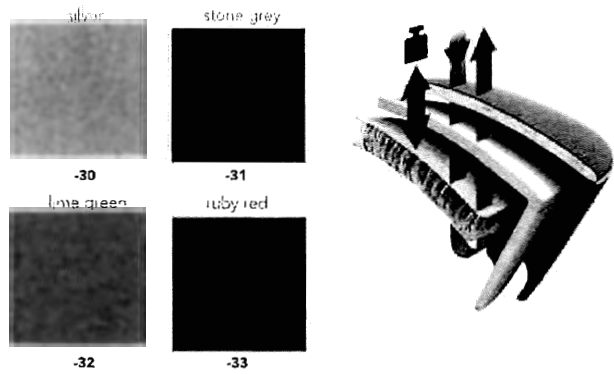

addition options (full list available in price book)

SUFFIX	DESCRIPTION
-R	black casters (air and made-to-order only)



swopper®

for the benefit of your back

MOTION SEATING



made-to-order



classic



air



saddle



high

Swopper is the perfect solution for anyone looking to remain comfortable and engaged while sitting. This unique seat supports a healthy back and spine allowing continuous and sturdy 360° and vertical motion. Enhance your seat with Swopper Air, which uses a unique combination of special, high-tech cushioning with a new, climate-active seat cover. This sits snugly over 5 layers that provide a more comfortable, breathable, heat-regulating and pressure-relieving seat. Dress up your space with Swopper Classic, which offers matching springs to your seat.

Add wheels to Swopper Saddle and Air.

Save your back - sit on a swopper today.

Burn up to 400 calories a day sitting actively on a swopper!

True 48-Hour Commitment

- 20/48 20 Chairs Every 48 Hours
- 10/48 10 Chairs Every 48 Hours
- ▲ CALL FOR LEAD TIME (1-800-433-6614)



Passes or exceeds all BIFMA required testing



SWOPPER - SWUS_CUSTOM

MADE-TO-ORDER

STANDARD: 1-SWUS_CUSTOM-A-GR 1

True 48-Hour Commitment

- 20/48 20 Chairs Every 48 Hours
- 10/48 10 Chairs Every 48 Hours
- ▲ **CALL FOR LEAD TIME** (1-800-433-6614)

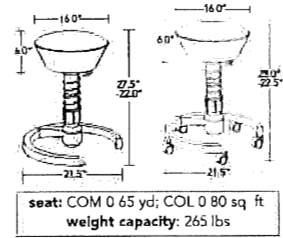

seat: COM 0 65 yd; COL 0 80 sq ft
weight capacity: 265 lbs

Step 1: BASE COLOR

- A ANTHRACITE • **STANDARD**
- T TITANIUM • \$26

Step 1a: CASTER OPTION

Suffix	QS	Description	Price
R	●	Black Casters (anthracite base only)	\$89

Step 2: FABRIC GRADES

Fabric Upgrade	GR 1/COM	GR 2	GR 3/COL	GR 4	GR 5	GR 6	GR 7	GR 8
Upcharge	STANDARD	\$15	\$40	\$69	\$103	\$148	\$202	\$271

BUILD YOUR PART NUMBER

SWUS- -
STEP 1 STEP 1a STEP 2



SWOPPER - SWUS_CLASSIC

CLASSIC WITH MATCHING SPRING, ANTHRACITE BASE

STANDARD: 1-SWUS_CLASSIC-10

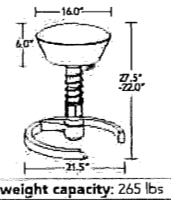

weight capacity: 265 lbs

Step 1: SEAT FABRIC AND SPRING COLOR

NO UPCHARGE	SUFFIX	QS	DESCRIPTION	SUFFIX	QS	DESCRIPTION
	-01	●	Red Seat/Red Spring	-07	●	Orange Seat/Orange Spring
	-02	●	Carbon Seat/Anthracite Spring	-10	●	Black Seat/Anthracite Spring
	-06	●	Blue Seat/Blue Spring			

BUILD YOUR PART NUMBER

SWUS-
STEP 1



SWOPPER - SWUS_SADDLE

SADDLE BLACK LEATHER SEAT, ANTHRACITE BASE

STANDARD: 1-SWUS-SADDLE

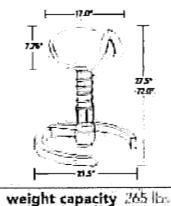

weight capacity: 265 lbs

Step 1: CASTER OPTION

SUFFIX	QS	DESCRIPTION	Price
-R	●	Black Casters	\$89

BUILD YOUR PART NUMBER

SWUS-SADDLE-
STEP 1

\$1,200
BASE MODEL

SWOPPER - SWUS_AIR

AIR, ANTHRACITE BASE

STANDARD: 1-SWUS_AIR-30

True 48-Hour Commitment

- **20/48** 20 Chairs Every 48 Hours
- **10/48** 10 Chairs Every 48 Hours
- ▲ **CALL FOR LEAD TIME** (1-800-433-6614)

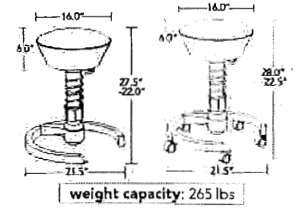

Step 1: SEAT FABRIC AND SPRING COLOR

	SUFFIX	QS	DESCRIPTION	SUFFIX	QS	DESCRIPTION
NO UPCHARGE	-30	●	Silver	-32	●	Lime Green
	-31	●	Stone Grey	-33	●	Ruby Red

Step 1a: CASTER OPTIONS

Suffix	QS	Description	Price
R	●	Black Casters	\$89
(N/A on titanium base)			

BUILD YOUR PART NUMBER

SWUS-AIR- -
STEP 1 STEP 1a

\$1,278
BASE MODEL

SWOPPER - SWUS_HIGH

HIGH, ANTHRACITE BASE

STANDARD: 1-SWUS_HIGH-A-GR 1

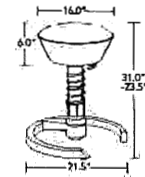

seat: COM 0 65 yd; COL 0 80 sq ft.
weight capacity: 265 lbs

Step 1: FABRIC GRADES

Fabric Upgrade	GR 1/COM	GR 2	GR 3/COL	GR 4	GR 5	GR 6	GR 7	GR 8
Upcharge	STANDARD	\$15	\$41	\$70	\$105	\$151	\$206	\$276

BUILD YOUR PART NUMBER

SWUSH-
STEP 1

via seating warranty statement

sweet 

via seating warrants to the initial purchaser, that product will be free from defects in its materials and craftsmanship found during normal single shift usages; single shift usage is five (5) days a week, eight (8) hours a day for the following warranty periods. This coverage shall be effective for the applicable time period beginning from date of original sale.

Unless otherwise specified, all components are covered by via seating's lifetime warranty - including foam.

lifetime warranty coverage defined as

- All via seating products, INCLUDING VIA SEATING FOAM, are warranted for 12 Years. Please note exceptions below:

24/7 shift application, 12 year warranty coverage

- 12 Years – Brisbane HD, 24/7 (2 years for fabric) – Genie 24/7 – (5 years for mesh)
- 12 Years – Vista Classic, Vista II

other exceptions

- 10 Years – Vista Classic, Vista II – with casters
- 6 Years – Splash, Sutro, Zee
- 5 Years – In-stock leathers, fabric, Genie™ mesh
- 5 Years – swopper
- 3 Years – 3Dee, muvman and oyo
- 2 Years – Mesh back fabric (Voss, Riva, Proform™, Run)
- 2 Years – Mechanical lumbar & air lumbar options

Products covered by this warranty will be either repaired or replaced at via seating's discretion. Product repair or replacement of any defective part is the customer's exclusive remedy for any and all product defects. via seating will pay for warranty repair costs that are pre-approved when shown to be a result of a defective part. Such payment will be made in the form of a credit to an active authorized via seating dealer account. via seating accepts no other responsibilities or liabilities. Only those items free of misuse, abuse, accident, alteration, unauthorized repair, or damage by fire, flood, or other acts of God will be covered. This warranty applies to all via seating products manufactured after January 1, 2016. There are no other warranties, expressed or implied, other than those specifically described here.

not covered under warranty

- COM/COL textiles
- Matching of colors, patterns or dye lot, including; minor variations, color matches to swatches used for specification purposes and/or prior purchases
- Products specified outside of those shown in this price list
- Products that have unauthorized repair or alteration
- Products not used, maintained or installed in accordance with via seating's applicable guidelines
- Products exposed to conditions deemed extreme i.e. environments other than "normal commercial, indoor office" spaces
- Products sold by unauthorized via seating Dealers or second hand/refurbished products
- Variations of leather; dye lots, environment marks, scars, bites, rubs, wrinkles, stretch marks, pattern markings, etc.
- Samples; floor/showroom samples, road samples

warranty claims

- Do not return the product without prior Return Material Authorization (RMA) from via seating
- Send a written notification (with pictures) of the defect to via seating along with a copy of the original invoice in order to generate a Return Material Authorization
- Please contact via seating customer service at 1-800-433-6614 for details or email warranty@viaseating.com

ANSI/BIFMA compliance

- via seating Products - via seating designs and manufactures all of its products in accordance with the ANSI/BIFMA standards
- Motion Products - aeris GMBH manufactures all of these products in accordance with European DINN standards

product design

- via seating reserves the right to make changes in design and construction or discontinue products without notice
- All dimensions noted herein are approximate and subject to slight deviation



OFFICE INTERIORS
& D E S I G N

References for Seating contract 18-117

1. American National Bank 8990 West Dodge Road Omaha, NE
Jim Burns 402-399-5026 jburns@anbank.com
American National Bank has been standardized on RFM seating including Evolve BT-16 Bari task chair. They use them through-out their Omaha and Council Bluffs branch locations.
2. Foundation for Educational Service 1300 O street Lincoln, NE
Susan Garcia 402-479-6631 susang@fes.org
FES has recently standardized on the Allseating You task chair for over 80 employees and has plans for ordering an additional 80+ You task chairs in the near future.
3. City of Lincoln / Lancaster County have purchased many Teknion Savera task chairs over the years as well as purchased the Teknion Savera XL task chair. Many departments have purchased the Via Proform task chair.