

CONTRACT DOCUMENTS

**CITY OF LINCOLN, NEBRASKA,
LANCASTER COUNTY,
CITY OF LINCOLN - LANCASTER COUNTY
PUBLIC BUILDING COMMISSION**

**Annual Supply
Office Seating
Bid No. 18-117**

**encompas (encompas Corporation)
707 South 15th Street
Omaha, NE 68102
(402) 991-7471**

**CITY OF LINCOLN-LANCASTER COUNTY, NEBRASKA and
LINCOLN-LANCASTER COUNTY PUBLIC BUILDING COMMISSION
CONTRACT TERMS**

THIS CONTRACT, made and entered into by and between **encompas (encompas Corporation), 707 South 15th Street, Omaha, NE 68102**, hereinafter called "Contractor", and the City of Lincoln, Nebraska, a municipal corporation, and the County of Lancaster, Nebraska, a political subdivision of the State of Nebraska, and the Lincoln-Lancaster County Public Building Commission hereinafter called the "Owners".

WHEREAS, the Owners have caused to be prepared, in accordance with law, Specifications, Plans, and other Contract Documents for the Work herein described, and has approved and adopted said documents and has caused to be published an advertisement for and in connection with said Work, to-wit:

Office Seating, Bid No. 18-117

and,

WHEREAS, the Contractor, in response to such advertisement, has submitted to the Owners, in the manner and at the time specified, a sealed Proposal/Supplier Response in accordance with the terms of said advertisement; and,

WHEREAS, the Owners, in the manner prescribed by law has publicly opened, read aloud, examined, and canvassed the Proposals/Supplier Responses submitted in response to such advertisement, and as a result of such canvass has determined and declared the Contractor to be the lowest responsible bidder for the said Work for the sum or sums named in the Contractor's Proposal/Supplier Responses, a copy thereof being attached to and made a part of this Contract;

NOW, THEREFORE, in consideration of the sums to be paid to the Contractor and the mutual covenants herein contained, the Contractor and the Owners have agreed and hereby agree as follows:

1. The Contractor agrees to (a) furnish all tools, equipment, supplies, superintendence, transportation, and other accessories, services, and facilities; (b) furnish all materials, supplies, and equipment specified to be incorporated into and form a permanent part of the complete work; (c) provide and perform all necessary labor in a substantial and workmanlike manner and in accordance with the provisions of the Contract Documents; and (d) execute and complete all Work included in and covered by the Owners' award of this Contract to the Contractor, such award being based on the acceptance by the Owner of the Contractor's Proposal, or part thereof, as follows:

Agreement to Line Item Number 3, 4 and Line 4 Alternate of Contractor's Proposal

2. The Owners agree to pay to the Contractor for the performance of the Work embraced in this Contract, the Contractor agrees to accept as full compensation therefore, the following sums and prices for all Work covered by and included in the Contract award and designated above, payment thereof to be made in the manner provided by the Owners:

"Contracted Vendors" shall mean all vendors who contract or who have contracted with the Owners pursuant to Bid No. 18-117, Annual Supply – Office Seating.

"Contracts" shall mean the collective contracts entered into between the Owners and the Contracted Vendors pursuant to Bid No. 18-117, Annual Supply – Office Seating.

The Owners will pay for products/service, according to the Line Item pricing as listed in Contractors Proposal/Supplier Response, a copy thereof being attached to and made a part of this Contract. The Owners shall order on an as-needed basis for the duration of the contract. The cost of products or services for City Departments shall not exceed \$45,000.00 for Contracts during the contract term without approval. The cost of products or services for County Agencies shall not exceed \$30,000.00 for Contracts during the contract term without approval by the Board of Commissioners. The cost of products or services for the Public Building Commission shall not exceed \$5,000.00 for Contracts during the contract term without approval by the Board of the Public Building Commission.

3. Equal Employment Opportunity. In connection with the carrying out of this project, the contractor shall not discriminate against any employee or applicant for employment because of race, color, religion, sex, national origin, ancestry, disability, age or marital status. The Contractor will take affirmative action to ensure that applicants are employed, and that employees are treated during employment, without regard to their race, color, religion, sex, national origin, ancestry, disability, age or marital status. Such action shall include, but not be limited to, the following: employment, upgrading, demotion or transfer; recruitment or recruitment advertising; layoff or termination; rates of pay or other compensation; and selection for training, including apprenticeship.
4. E-Verify. In accordance with Neb. Rev. Stat. 4-108 through 4-114, the contractor agrees to register with and use a federal immigration verification system, to determine the work eligibility status of new employees performing services within the state of Nebraska. A federal immigration verification system means the electronic verification of the work authorization program of the Illegal Immigration Reform and Immigrant Responsibility Act of 1996, 8 U.S.C. 1324 a, otherwise known as the E-Verify Program, or an equivalent federal program designated by the United States Department of Homeland Security or other federal agency authorized to verify the work eligibility status of a newly hired employee pursuant to the Immigration Reform and Control Act of 1986. The Contractor shall not discriminate against any employee or applicant for employment to be employed in the performance of this section pursuant to the requirements of state law and 8 U.S.C.A 1324b. The contractor shall require any subcontractor to comply with the provisions of this section.
5. Termination. This Contract may be terminated by the following:
 - 5.1) Termination for Convenience. Either party may terminate this Contract upon thirty (30) days written notice to the other party for any reason without penalty.
 - 5.2) Termination for Cause. The Owners may terminate the Contract for cause if the Contractor:
 - 5.2.1) Refuses or fails to supply the proper labor, materials and equipment necessary to provide services and/or commodities.
 - 5.2.2) Disregards Federal, State or local laws, ordinances, regulations, resolutions or orders.
 - 5.2.3) Otherwise commits a substantial breach or default of any provision of the Contract Document. In the event of a substantial breach or default the Owners will provide the Contractor written notice of said breach or default and allow the Contractor ten (10) days from the date of the written notice to cure such breach or default. If said breach or default is not cured within ten (10) days from the date of notice, then the contract shall terminate.
6. Independent Contractor. It is the express intent of the parties that this contract shall not create an employer-employee relationship. Employees of the Contractor shall not be deemed to be employees of the Owners and employees of the Owners shall not be deemed to be employees of the Contractor. The Contractor and the Owners shall be responsible to their respective employees for all salary and benefits. Neither the Contractor's employees nor the Owners' employees shall be entitled to any salary, wages, or benefits from the other party, including but not limited to overtime, vacation, retirement benefits, workers' compensation, sick leave or injury leave. Contractor shall also be responsible for maintaining workers' compensation insurance, unemployment insurance for its employees, and for payment of all federal, state, local and any other payroll taxes with respect to its employees' compensation.

7. Owner Inclusion. It is understood and agreed by all parties that "Owner/s" shall include the City of Lincoln, Lancaster County, Nebraska and Lincoln-Lancaster County Public Building Commission. Whenever in the Contract documents, including the instructions to bidders, specifications, insurance requirements, bonds, and terms and conditions or any other documents which are a part of the Contract, a singular entity is referenced (i.e., "the City" or "the County" or "Building Commission") it shall mean the "Owners" encompassing the City of Lincoln, Lancaster County and Lincoln-Lancaster County Building Commission. Notwithstanding the foregoing, the duties and obligations of the City, the County, and the Building Commission pursuant to the Contract shall be treated as divisible and severable duties and obligations, and default by any one of the City, the County, or the Building Commission shall not be attributed to any other of the Owners, but shall remain the sole obligation of the defaulting entity.
8. Audit Provision: The Contractor shall be subject to an audit and shall, upon request, make available to the Public Building Commission or a contract auditor hired by the Public Service Commission, copies of all financial and performance related records and materials related to this Agreement, as allowed by law.
9. Period of Performance. This Contract shall be effective upon execution by all parties. The term of the Contract shall be a one (1) year term with the option to renew for four (4) additional one (1) year terms.
10. The Contract Documents comprise the Contract, and consist of the following:
1. Contract Terms
 2. Accepted Proposal/Response
 3. Insurance Certificate with Endorsements
 4. Sample Order Form
 5. Special Provisions
 6. Specifications
 7. Instructions to Bidders
 8. Insurance Requirements
 9. Sales Tax Exemption Form 13
- (Note: This form cannot be used for the WATER Division of the City of Lincoln. The WATER Division is taxable per Reg. 066.14A or applicable laws.)

The herein above mentioned Contract Documents form this Contract and are a part of the Contract as if hereto attached. Said documents which are not attached to this document may be viewed at: lincoln.ne.gov - Keyword: Bid - Awarded or Closed bids.

The Contractor and the Owners hereby agree that all the terms and conditions of this Contract shall be binding upon themselves, and their heirs, administrators, executors, legal and personal representatives, successors, and assigns.

IN WITNESS WHEREOF, the Contractor and the Owners do hereby execute this contract upon completion of signatures on:

Vendor Signature Page
 City of Lincoln Signature Page
 Lancaster County Signature Page
 City of Lincoln-Lancaster County Public Building Commission Signature Page

Vendor Signature Page

**CONTRACT
Annual Supply
Office Seating
Bid No. 18-117
City of Lincoln, Lancaster County and
City of Lincoln-Lancaster County Public Building Commission
encompas (encompas Corporation)**

EXECUTION BY CONTRACTOR

IF A CORPORATION:

Attest:

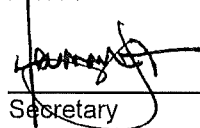

Secretary

Seal

encompas

Name of Corporation

707 South 15th Street, Omaha, NE 68102

Address

By:

Duly Authorized Official

Vice President

Legal Title of Official

IF OTHER TYPE OF ORGANIZATION:

Name of Organization

Type of Organization

Address

By:

Member

By:

Member

IF AN INDIVIDUAL:

Name

Address

Signature

City of Lincoln Signature Page

**CONTRACT
Annual Supply
Office Seating
Bid No. 18-117
City of Lincoln, Lancaster County and
City of Lincoln-Lancaster County Public Building Commission
encompas (encompas Corporation)**

EXECUTION BY THE CITY OF LINCOLN, NEBRASKA

ATTEST:

City Clerk

CITY OF LINCOLN, NEBRASKA

Chris Beutler, Mayor

Approved by Executive Order No. _____

dated _____

Lancaster County Signature Page

CONTRACT
Annual Supply
Office Seating
Bid No. 18-117
City of Lincoln, Lancaster County and
City of Lincoln-Lancaster County Public Building Commission
encompas (encompas Corporation)

EXECUTION BY LANCASTER COUNTY, NEBRASKA

Contract Approved as to Form:

The Board of County Commissioners of
Lancaster, Nebraska

Deputy Lancaster County Attorney

dated _____

**Lincoln-Lancaster County Public Building Commission
Signature Page**

**CONTRACT
Annual Supply
Office Seating
Bid No. 18-117
City of Lincoln, Lancaster County and
City of Lincoln-Lancaster County Public Building Commission
encompas (encompas Corporation)**

EXECUTION BY LINCOLN-LANCASTER COUNTY PUBLIC BUILDING COMMISSION

ATTEST:

Public Building Commission Attorney

Chairperson, Public Building Commission

dated _____

City of Lincoln/Lancaster County (Lincoln Purchasing) Supplier Response

Bid Information		Contact Information		Ship to Information
Bid Creator	Sharon Mulder Asst Purchasing Agent	Address	Purchasing 440 S. 8th St. Lincoln, NE 68508	Address
Email	smulder@lincoln.ne.gov	Contact	Sharon Mulder Asst Purchasing Agent	Contact
Phone	(402) 441-7428 x			
Fax	(402) 441-6513 x			
Bid Number	18-117	Department		Department
Title	Office Seating	Building		Building
Bid Type	Bid		Suite 200	Floor/Room
Issue Date	5/2/2018 03:00 PM (CT)	Floor/Room		Telephone
Close Date	5/16/2018 12:00:00 PM (CT)	Telephone	(402) 441-7428 x	Fax
		Fax	(402) 441-6513 x	Email
		Email	smulder@lincoln.ne.gov	

Supplier Information

Company	encompas (encompas Corporation)
Address	707 South 15th Street Omaha, NE 68102
Contact	Marco Lade
Department	
Building	
Floor/Room	
Telephone	(402) 991-7471
Fax	(402) 991-7472
Email	marco@encompas-ne.com
Submitted	5/16/2018 11:35:26 AM (CT)
Total	\$3,074.17

By submitting your response, you certify that you are authorized to represent and bind your company.

Signature Marco Lade

Email marco@encompas.com

Supplier Notes

Bid Notes

Bid Activities

Bid Messages

Bid Attributes

Please review the following and respond where necessary

#	Name	Note	Response
1	Instructions to Bidders	I acknowledge reading and understanding the Instructions to Bidders.	Yes
2	Specifications	I acknowledge reading and understanding the specifications.	Yes
3	Delivery	State number of delivery days ARO. FOB to the City/County at the location specified with all transportation charges paid.	20 Business Days
4	Insurance Requirements and Endorsements	<p>Vendor agrees to provide insurance coverage for each checked box on the Insurance Clause document in the Bid Attachments including the submission of the Certificate of ACORD and the applicable endorsements.</p> <p>Insurance Certificate and required Endorsements are required at time of contract execution by the vendor.</p> <p>Vendors are strongly encouraged to send the insurance requirements and endorsement information to their insurance agent prior to bid close in order to expedite the contract execution process.</p>	Yes
5	Sample Contract	I acknowledge reading and understanding the sample contract.	Yes
6	Purchase Order, Contract and Delivery Contact	<p>The City/County Purchasing Department issues Purchase Orders and Contracts via email to a designated contact person of the awarded Vendor. This designee will be the primary contact with the department through the delivery of the product/services.</p> <p>Please list the name, email address and phone number of the person who will be the contact person for the PO to be awarded.</p>	<p>Marco Lade, marco@encompas.com, 402.991.7471 (office) 402.714.4798 (cell)</p>
7	Contact	Name of person submitting this bid:	Marco Lade
8	Special Provision Term Contract Provisions	I acknowledge reading and understanding the Special Provision Term Contract Provisions.	Yes
9	Renewal is an Option	Contract Extension Renewal is an option.	Yes
10	Term Clause of Contract	<p>I acknowledge that the term of the contract is for a one (1) year term with the option for four (4) additional one (1) year renewals from the date of the executed contract. (a) Are your bid prices firm for the first one (1) year contract period. YES or NO _____</p> <p>(b) Are your bid prices subject to escalation/de-escalation YES or NO _____</p> <p>(c) If (b), state period for which prices will remain firm: through _____</p>	<p>a) yes b) a manufacturer's price increase would be passed on to the city after each published announcement c) pricing submitted today is firm through 12/31/2019. Longer if no price increase is published by Haworth or Via</p>
11	Contractor Must Provide References in Bidders Response Section	<p>Contractor must provide (2) two references for where the chairs being offered are currently in use. Each reference must include the following:</p> <p>Owner: Street Address: City: State: Zip: Name Owners Representative: Phone: Project Name and/or Number: Contract Amount: Completion Date:</p>	YES

- | | | | |
|----|-----------------------------------|---|-------------------------------------|
| 12 | Debarred | Has your company ever been debarred or suspended for doing business with the City of Lincoln/Lancaster County/PBC of Nebraska | No |
| 13 | U.S. Citizenship Attestation | <p>Is your company legally considered an Individual or Sole Proprietor: YES or NO</p> <p>As a Vendor who is legally considered an Individual or a Sole Proprietor I hereby understand and agree to comply with the requirements of the United States Citizenship Attestation Form, available at:
 http://www.sos.ne.gov/business/notary/citizenforminfo.html</p> <p>All awarded Vendors who are legally considered an Individual or a Sole Proprietor must complete the form and submit it with contract documents at time of execution.</p> <p>If a Vendor indicates on such attestation form that he or she is a qualified alien, the Vendor agrees to provide the US Citizenship and Immigration Services documentation required to verify the Vendor's lawful presence in the United States using the Systematic Alien Verification for Entitlements (SAVE) Program.</p> <p>Vendor further understands and agrees that lawful presence in the United States is required and the Vendor may be disqualified or the Contract terminated if such lawful presence cannot be verified as required by Neb. Rev. Stat. 4-108.</p> | <p>encompas is an S-Corporation</p> |
| 14 | Bid Award | <p>a) I acknowledge and understand that the City, County and/or Public Building Commission reserves the right to award bids item-by-item, with or without alternates/options, by groups, or "lump sum" such as shall best serve the requirements and interests of the City, County and/or Public Building Commission. Do you agree and understand? Yes/No_____</p> <p>b) Is your pricing based on all-or-nothing basis, please indicate is so. Yes/No_____</p> | <p>a) Yes b) No</p> |
| 15 | Recycling of Corrugated Cardboard | I acknowledge that I must comply with the City of Lincoln recycling regulations which includes a ban of all corrugated cardboard from the City Landfill effective April 1, 2018. Vendors are encouraged to utilize recycling sites located throughout the city of Lincoln to dispose of corrugated cardboard. | Yes |
| 16 | Electronic Signature | Please check here for your electronic signature. | Yes |

Line Items

#	Qty	UOM	Description	Response
1	1	EA	Fully Functional Office Seating Chairs that fall into the Owners price range of \$300.00 to \$400.00	\$347.27

Item Notes: A minimum of two (2) chairs will be selected for this category with the Owner's determining if additional chairs will be added. If you wish to bid more chairs, you can click in the bid line; "add alternate" to add additional chairs.

Supplier Notes:

Item Attributes: Please review the following and respond where necessary

#	Name	Note	Response
1	Manufacturer and Model	Please provide the Manufacturer and Model bidding.	Haworth Soji
2	Warranty	I acknowledge that I have attached the warranty information related to each chair bidding to the Vendor's Response Attachment Section of the e-bid.	Yes
3	Manufacturer's Price List	I acknowledge that I have attached the Manufacturer's Price List for our basis of pricing to the Vendor's Response Attachment Section of the e-bid.	Yes
4	Discount Schedule	I acknowledge that I have attached the Discount Schedule per Specifications, Section 2, 2.2.4 and 2.2.4.1 to the Vendor's Response Attachment Section of the e-bid.	Yes

2	1	EA	Functional Office Seating Chairs that fall into the Owners price range of \$400.00 to \$500.00	\$455.35
---	---	----	--	----------

Item Notes: A minimum of two (2) chairs will be selected for this category with the Owner's determining if additional chairs will be added. If you wish to bid more chairs, you can click in the bid line; "add alternate" to add additional chairs.

Supplier Notes:

Item Attributes: Please review the following and respond where necessary

#	Name	Note	Response
1	Manufacturer and Model	Please provide the Manufacturer and Model bidding.	Haworth Very
2	Warranty	I acknowledge that I have attached the warranty information related to each chair bidding to the Vendor's Response Attachment Section of the e-bid.	Yes
3	Manufacturer's Price List	I acknowledge that I have attached the Manufacturer's Price List for our basis of pricing to the Vendor's Response Attachment Section of the e-bid.	Yes
4	Discount Schedule	I acknowledge that I have attached the Discount Schedule per Specifications, Section 2, 2.2.4 and 2.2.4.1 to the Vendor's Response Attachment Section of the e-bid.	Yes

3 1 EA Functional Office Seating Chairs that fall into the Owners price range of \$500.00 to \$600.00 \$579.48

Item Notes: A minimum of two (2) chairs will be selected for this category with the Owner's determining if additional chairs will be added. If you wish to bid more chairs, you can click in the bid line; "add alternate" to add additional chairs.

Supplier Notes:

Item Attributes: Please review the following and respond where necessary

#	Name	Note	Response
1	Manufacturer and Model	Please provide the Manufacturer and Model bidding.	Haworth Zody
2	Warranty	I acknowledge that I have attached the warranty information related to each chair bidding to the Vendor's Response Attachment Section of the e-bid.	Yes
3	Manufacturer's Price List	I acknowledge that I have attached the Manufacturer's Price List for our basis of pricing to the Vendor's Response Attachment Section of the e-bid.	Yes
4	Discount Schedule	I acknowledge that I have attached the Discount Schedule per Specifications, Section 2, 2.2.4 and 2.2.4.1 to the Vendor's Response Attachment Section of the e-bid.	Yes

4 1 EA Functional Office Seating Chairs that fall into the Owners price range of \$600.00 to \$750.00 \$625.23

Item Notes: A minimum of two (2) chairs will be selected for this category with the Owner's determining if additional chairs will be added. If you wish to bid more chairs, you can click in the bid line; "add alternate" to add additional chairs.

Supplier Notes:

Item Attributes: Please review the following and respond where necessary

#	Name	Note	Response
1	Manufacturer and Model	Please provide the Manufacturer and Model bidding.	Haworth Fern
2	Warranty	I acknowledge that I have attached the warranty information related to each chair bidding to the Vendor's Response Attachment Section of the e-bid.	Yes
3	Manufacturer's Price List	I acknowledge that I have attached the Manufacturer's Price List for our basis of pricing to the Vendor's Response Attachment Section of the e-bid.	Yes
4	Discount Schedule	I acknowledge that I have attached the Discount Schedule per Specifications, Section 2, 2.2.4 and 2.2.4.1 to the Vendor's Response Attachment Section of the e-bid.	Yes

Alt 1 1 EA Alt Spec: Functional Office Seating Chairs that fall into the Owner's price range of \$600.00 to \$750.00 645.22

Alt Manufacturer: Haworth Alt Manufacturer #: M251-1G43

Item Notes: A minimum of two (2) chairs will be selected for this category with the Owner's determining if additional chairs will be added. If you wish to bid more chairs, you can click in the bid line; "add alternate" to add additional chairs.

Supplier Notes:

Item Attributes: Please review the following and respond where necessary

#	Name	Note	Response
1	Manufacturer and Model	Please provide the Manufacturer and Model bidding.	Haworth Improv H.E.
2	Warranty	I acknowledge that I have attached the warranty information related to each chair bidding to the Vendor's Response Attachment Section of the e-bid.	Yes
3	Manufacturer's Price List	I acknowledge that I have attached the Manufacturer's Price List for our basis of pricing to the Vendor's Response Attachment Section of the e-bid.	Yes
4	Discount Schedule	I acknowledge that I have attached the Discount Schedule per Specifications, Section 2, 2.2.4 and 2.2.4.1 to the Vendor's Response Attachment Section of the e-bid.	Yes

5 1 EA Functional Bariatric Office Seating Chairs \$1,066.84

Item Notes: A minimum of two (2) chairs will be selected for this category with the Owner's determining if additional chairs will be added. If you wish to bid more chairs, you can click in the bid line; "add alternate" to add additional chairs.

Supplier Notes: Haworth Improv H.E. XL is rated for 500 lbs. Technically, it is not defined as a 'bariatric' chair.....but instead, a model suited for 'big & tall' individuals. Our alternate, the Via 4U...is rated to 400 lbs.

Item Attributes: Please review the following and respond where necessary

#	Name	Note	Response
1	Manufacturer and Model	Please provide the Manufacturer and Model bidding.	Haworth Improv H.E. XL
2	Warranty	I acknowledge that I have attached the warranty information related to each chair bidding to the Vendor's Response Attachment Section of the e-bid.	Yes
3	Manufacturer's Price List	I acknowledge that I have attached the Manufacturer's Price List for our basis of pricing to the Vendor's Response Attachment Section of the e-bid.	Yes
4	Discount Schedule	I acknowledge that I have attached the Discount Schedule per Specifications, Section 2, 2.2.4 and 2.2.4.1 to the Vendor's Response Attachment Section of the e-bid.	Yes

Alt Manufacturer: Via Alt Manufacturer #: 781-B-LS4B-68C-12SS-38A-XX-17AB-18BB-16HP-01U

Item Notes: A minimum of two (2) chairs will be selected for this category with the Owner's determining if additional chairs will be added. If you wish to bid more chairs, you can click in the bid line; "add alternate" to add additional chairs.

Supplier Notes:

Item Attributes: Please review the following and respond where necessary

#	Name	Note	Response
1	Manufacturer and Model	Please provide the Manufacturer and Model bidding.	Via 4U
2	Warranty	I acknowledge that I have attached the warranty information related to each chair bidding to the Vendor's Response Attachment Section of the e-bid.	Yes
3	Manufacturer's Price List	I acknowledge that I have attached the Manufacturer's Price List for our basis of pricing to the Vendor's Response Attachment Section of the e-bid.	Yes
4	Discount Schedule	I acknowledge that I have attached the Discount Schedule per Specifications, Section 2, 2.2.4 and 2.2.4.1 to the Vendor's Response Attachment Section of the e-bid.	Yes

Response Total: \$3,074.17

This page has been left blank intentionally.

**COMMERCIAL AUTOMOBILE
COVERAGE PART - DECLARATIONS
BUSINESS AUTO COVERAGE FORM**



POLICY NUMBER: 37 UEC VT6194

This COMMERCIAL AUTOMOBILE COVERAGE PART consists of:

- A. This Declarations Form;
- B. Business Auto Coverage Form; and
- C. Any Endorsements issued to be a part of this Coverage Form and listed below.

ITEM ONE - NAMED INSURED AND ADDRESS

The Named Insured is stated on the Common Policy Declarations.

ADVANCE PREMIUM: \$

AUDIT PERIOD:

Except in this Declarations, when we use the word "Declarations" in this Coverage Part, we mean this "Declarations" or the "Common Policy Declarations".

Form Numbers of Coverage Forms, Endorsements and Schedules that are part of this Coverage Part:

HA00040302	HA00120615T	CA00011013	HA21020614	CA99031013
CA21041013	CA31041013	CA01650716	CA01661013	CA02190116
CA05020416	CA20481013	CA23441116	HA00240614	HA99080614
HA99160312	IH12011185			

THIS ENDORSEMENT CHANGES THE POLICY. PLEASE READ IT CAREFULLY.

COMMERCIAL AUTOMOBILE BROAD FORM ENDORSEMENT

This endorsement modifies insurance provided under the following:

BUSINESS AUTO COVERAGE FORM

To the extent that the provisions of this endorsement provide broader benefits to the "insured" than other provisions of the Coverage Form, the provisions of this endorsement apply.

1. BROAD FORM INSURED

A. Subsidiaries and Newly Acquired or Formed Organizations

The Named Insured shown in the Declarations is amended to include:

- (1) Any legal business entity other than a partnership or joint venture, formed as a subsidiary in which you have an ownership interest of more than 50% on the effective date of the Coverage Form. However, the Named Insured does not include any subsidiary that is an "insured" under any other automobile policy or would be an "insured" under such a policy but for its termination or the exhaustion of its Limit of Insurance.
- (2) Any organization that is acquired or formed by you and over which you maintain majority ownership. However, the Named Insured does not include any newly formed or acquired organization:
 - (a) That is a partnership or joint venture,
 - (b) That is an "insured" under any other policy,
 - (c) That has exhausted its Limit of Insurance under any other policy, or
 - (d) 180 days or more after its acquisition or formation by you, unless you have given us notice of the acquisition or formation.

Coverage does not apply to "bodily injury" or "property damage" that results from an "accident" that occurred before you formed or acquired the organization.

B. Employees as Insureds

Paragraph A.1. - WHO IS AN INSURED - of SECTION II - LIABILITY COVERAGE is amended to add:

- d. Any "employee" of yours while using a covered "auto" you don't own, hire or borrow in your business or your personal affairs.

C. Lessors as Insureds

Paragraph A.1. - WHO IS AN INSURED - of Section II - Liability Coverage is amended to add:

- e. The lessor of a covered "auto" while the "auto" is leased to you under a written agreement if:
 - (1) The agreement requires you to provide direct primary insurance for the lessor and
 - (2) The "auto" is leased without a driver.

Such a leased "auto" will be considered a covered "auto" you own and not a covered "auto" you hire.

D. Additional Insured if Required by Contract

- (1) Paragraph A.1. - WHO IS AN INSURED - of Section II - Liability Coverage is amended to add:
 - f. When you have agreed, in a written contract or written agreement, that a person or organization be added as an additional insured on your business auto policy, such person or organization is an "insured", but only to the extent such person or organization is liable for "bodily injury" or "property damage" caused by the conduct of an "insured" under paragraphs a. or b. of Who Is An Insured with regard to the ownership, maintenance or use of a covered "auto."

The insurance afforded to any such additional insured applies only if the "bodily injury" or "property damage" occurs:

- (1) During the policy period, and
- (2) Subsequent to the execution of such written contract, and
- (3) Prior to the expiration of the period of time that the written contract requires such insurance be provided to the additional insured.

(2) How Limits Apply

If you have agreed in a written contract or written agreement that another person or organization be added as an additional insured on your policy, the most we will pay on behalf of such additional insured is the lesser of:

- (a) The limits of insurance specified in the written contract or written agreement; or
- (b) The Limits of Insurance shown in the Declarations.

Such amount shall be a part of and not in addition to Limits of Insurance shown in the Declarations and described in this Section.

(3) Additional Insureds Other Insurance

If we cover a claim or "suit" under this Coverage Part that may also be covered by other insurance available to an additional insured, such additional insured must submit such claim or "suit" to the other insurer for defense and indemnity.

However, this provision does not apply to the extent that you have agreed in a written contract or written agreement that this insurance is primary and non-contributory with the additional insured's own insurance.

(4) Duties in The Event Of Accident, Claim, Suit or Loss

If you have agreed in a written contract or written agreement that another person or organization be added as an additional insured on your policy, the additional insured shall be required to comply with the provisions in LOSS CONDITIONS 2. - DUTIES IN THE EVENT OF ACCIDENT, CLAIM, SUIT OR LOSS – OF SECTION IV – BUSINESS AUTO CONDITIONS, in the same manner as the Named Insured.

E. Primary and Non-Contributory if Required by Contract

Only with respect to insurance provided to an additional insured in 1.D. - Additional Insured If Required by Contract, the following provisions apply:

(3) Primary Insurance When Required By Contract

This insurance is primary if you have agreed in a written contract or written agreement that this insurance be primary. If other insurance is also primary, we will share with all that other insurance by the method described in Other Insurance 5.d.

(4) Primary And Non-Contributory To Other Insurance When Required By Contract

If you have agreed in a written contract or written agreement that this insurance is primary and non-contributory with the additional insured's own insurance, this insurance is primary and we will not seek contribution from that other insurance.

Paragraphs (3) and (4) do not apply to other insurance to which the additional insured has been added as an additional insured.

When this insurance is excess, we will have no duty to defend the insured against any "suit" if any other insurer has a duty to defend the insured against that "suit". If no other insurer defends, we will undertake to do so, but we will be entitled to the insured's rights against all those other insurers.

When this insurance is excess over other insurance, we will pay only our share of the amount of the loss, if any, that exceeds the sum of:

- (1) The total amount that all such other insurance would pay for the loss in the absence of this insurance; and
- (2) The total of all deductible and self-insured amounts under all that other insurance.

We will share the remaining loss, if any, by the method described in Other Insurance 5.d.

2. AUTOS RENTED BY EMPLOYEES

Any "auto" hired or rented by your "employee" on your behalf and at your direction will be considered an "auto" you hire.

The OTHER INSURANCE Condition is amended by adding the following:

If an "employee's" personal insurance also applies on an excess basis to a covered "auto" hired or rented by your "employee" on your behalf and at your direction, this insurance will be primary to the "employee's" personal insurance.

3. AMENDED FELLOW EMPLOYEE EXCLUSION

EXCLUSION 5. - FELLOW EMPLOYEE - of SECTION II - LIABILITY COVERAGE does not apply if you have workers' compensation insurance in-force covering all of your "employees".

Coverage is excess over any other collectible insurance.

4. HIRED AUTO PHYSICAL DAMAGE COVERAGE

If hired "autos" are covered "autos" for Liability Coverage and if Comprehensive, Specified Causes of Loss, or Collision coverages are provided under this Coverage Form for any "auto" you own, then the Physical Damage Coverages provided are extended to "autos" you hire or borrow, subject to the following limit.

The most we will pay for "loss" to any hired "auto" is:

- (1) \$100,000;
- (2) The actual cash value of the damaged or stolen property at the time of the "loss"; or
- (3) The cost of repairing or replacing the damaged or stolen property,

whichever is smallest, minus a deductible. The deductible will be equal to the largest deductible applicable to any owned "auto" for that coverage. No deductible applies to "loss" caused by fire or lightning. Hired Auto Physical Damage coverage is excess over any other collectible insurance. Subject to the above limit, deductible and excess provisions, we will provide coverage equal to the broadest coverage applicable to any covered "auto" you own.

We will also cover loss of use of the hired "auto" if it results from an "accident", you are legally liable and the lessor incurs an actual financial loss, subject to a maximum of \$1000 per "accident".

This extension of coverage does not apply to any "auto" you hire or borrow from any of your "employees", partners (if you are a partnership), members (if you are a limited liability company), or members of their households.

5. PHYSICAL DAMAGE - ADDITIONAL TEMPORARY TRANSPORTATION EXPENSE COVERAGE

Paragraph A.4.a. of SECTION III - PHYSICAL DAMAGE COVERAGE is amended to provide a limit of \$50 per day and a maximum limit of \$1,000.

6. LOAN/LEASE GAP COVERAGE

Under SECTION III - PHYSICAL DAMAGE COVERAGE, in the event of a total "loss" to a covered "auto", we will pay your additional legal obligation for any difference between the actual cash value of the "auto" at the time of the "loss" and the "outstanding balance" of the loan/lease.

"Outstanding balance" means the amount you owe on the loan/lease at the time of "loss" less any amounts representing taxes; overdue payments; penalties, interest or charges resulting from overdue payments; additional mileage charges; excess wear and tear charges; lease termination fees; security deposits not returned by the lessor; costs for extended warranties, credit life Insurance, health, accident or disability insurance purchased with the loan or lease; and carry-over balances from previous loans or leases.

7. AIRBAG COVERAGE

Under Paragraph B. EXCLUSIONS - of SECTION III - PHYSICAL DAMAGE COVERAGE, the following is added:

The exclusion relating to mechanical breakdown does not apply to the accidental discharge of an airbag.

8. ELECTRONIC EQUIPMENT - BROADENED COVERAGE

a. The exceptions to Paragraphs B.4 - EXCLUSIONS - of SECTION III - PHYSICAL DAMAGE COVERAGE are replaced by the following:

Exclusions **4.c.** and **4.d.** do not apply to equipment designed to be operated solely by use of the power from the "auto's" electrical system that, at the time of "loss", is:

- (1) Permanently installed in or upon the covered "auto";
- (2) Removable from a housing unit which is permanently installed in or upon the covered "auto";
- (3) An integral part of the same unit housing any electronic equipment described in Paragraphs (1) and (2) above; or

- (4) Necessary for the normal operation of the covered "auto" or the monitoring of the covered "auto's" operating system.

b. Section III – Version CA 00 01 03 10 of the Business Auto Coverage Form, Physical Damage Coverage, Limit of Insurance, Paragraph C.2 and Version CA 00 01 10 01 of the Business Auto Coverage Form, Physical Damage Coverage, Limit of Insurance, Paragraph C are each amended to add the following:

\$1,500 is the most we will pay for "loss" in any one "accident" to all electronic equipment (other than equipment designed solely for the reproduction of sound, and accessories used with such equipment) that reproduces, receives or transmits audio, visual or data signals which, at the time of "loss", is:

- (1) Permanently installed in or upon the covered "auto" in a housing, opening or other location that is not normally used by the "auto" manufacturer for the installation of such equipment;
- (2) Removable from a permanently installed housing unit as described in Paragraph 2.a. above or is an integral part of that equipment; or
- (3) An integral part of such equipment.

c. For each covered "auto", should loss be limited to electronic equipment only, our obligation to pay for, repair, return or replace damaged or stolen electronic equipment will be reduced by the applicable deductible shown in the Declarations, or \$250, whichever deductible is less.

9. EXTRA EXPENSE - BROADENED COVERAGE

Under Paragraph A. - COVERAGE - of SECTION III - PHYSICAL DAMAGE COVERAGE, we will pay for the expense of returning a stolen covered "auto" to you.

10. GLASS REPAIR - WAIVER OF DEDUCTIBLE

Under Paragraph D. - DEDUCTIBLE - of SECTION III - PHYSICAL DAMAGE COVERAGE, the following is added:

No deductible applies to glass damage if the glass is repaired rather than replaced.

11. TWO OR MORE DEDUCTIBLES

Under Paragraph D. - DEDUCTIBLE - of SECTION III - PHYSICAL DAMAGE COVERAGE, the following is added:

If another Hartford Financial Services Group, Inc. company policy or coverage form that is not an automobile policy or coverage form applies to the same "accident", the following applies:

- (1) If the deductible under this Business Auto Coverage Form is the smaller (or smallest) deductible, it will be waived;
- (2) If the deductible under this Business Auto Coverage Form is not the smaller (or smallest) deductible, it will be reduced by the amount of the smaller (or smallest) deductible.

12. AMENDED DUTIES IN THE EVENT OF ACCIDENT, CLAIM, SUIT OR LOSS

The requirement in LOSS CONDITIONS 2.a. - DUTIES IN THE EVENT OF ACCIDENT, CLAIM, SUIT OR LOSS - of SECTION IV - BUSINESS AUTO CONDITIONS that you must notify us of an "accident" applies only when the "accident" is known to:

- (1) You, if you are an individual;
- (2) A partner, if you are a partnership;
- (3) A member, if you are a limited liability company; or
- (4) An executive officer or insurance manager, if you are a corporation.

13. UNINTENTIONAL FAILURE TO DISCLOSE HAZARDS

If you unintentionally fail to disclose any hazards existing at the inception date of your policy, we will not deny coverage under this Coverage Form because of such failure.

14. HIRED AUTO - COVERAGE TERRITORY

Paragraph e. of GENERAL CONDITIONS 7. - POLICY PERIOD, COVERAGE TERRITORY - of SECTION IV - BUSINESS AUTO CONDITIONS is replaced by the following:

e. For short-term hired "autos", the coverage territory with respect to Liability Coverage is anywhere in the world provided that if the "insured's" responsibility to pay damages for "bodily injury" or "property damage" is determined in a "suit," the "suit" is brought in the United States of America, the territories and possessions of the United States of America, Puerto Rico or Canada or in a settlement we agree to.

15. WAIVER OF SUBROGATION

TRANSFER OF RIGHTS OF RECOVERY AGAINST OTHERS TO US - of SECTION IV - BUSINESS AUTO CONDITIONS is amended by adding the following:

We waive any right of recovery we may have against any person or organization with whom you have a written contract that requires such waiver because of payments we make for damages under this Coverage Form.

16. RESULTANT MENTAL ANGUISH COVERAGE

The definition of "bodily injury" in SECTION V-DEFINITIONS is replaced by the following:

"Bodily injury" means bodily injury, sickness or disease sustained by any person, including mental anguish or death resulting from any of these.

17. EXTENDED CANCELLATION CONDITION

Paragraph 2. of the COMMON POLICY CONDITIONS - CANCELLATION - applies except as follows:

If we cancel for any reason other than nonpayment of premium, we will mail or deliver to the first Named Insured written notice of cancellation at least 60 days before the effective date of cancellation.

18. HYBRID, ELECTRIC, OR NATURAL GAS VEHICLE PAYMENT COVERAGE

In the event of a total loss to a "non-hybrid" auto for which Comprehensive, Specified Causes of Loss, or Collision coverages are provided under this Coverage Form, then such Physical Damage Coverages are amended as follows:

- a. If the auto is replaced with a "hybrid" auto or an auto powered solely by electricity or natural gas, we will pay an additional 10%, to a maximum of \$2,500, of the "non-hybrid" auto's actual cash value or replacement cost, whichever is less,
- b. The auto must be replaced and a copy of a bill of sale or new lease agreement received by us within 60 calendar days of the date of "loss,"

c. Regardless of the number of autos deemed a total loss, the most we will pay under this Hybrid, Electric, or Natural Gas Vehicle Payment Coverage provision for any one "loss" is \$10,000.

For the purposes of the coverage provision,

- a. A "non-hybrid" auto is defined as an auto that uses only an internal combustion engine to move the auto but does not include autos powered solely by electricity or natural gas.
- b. A "hybrid" auto is defined as an auto with an internal combustion engine and one or more electric motors; and that uses the internal combustion engine and one or more electric motors to move the auto, or the internal combustion engine to charge one or more electric motors, which move the auto.

19. VEHICLE WRAP COVERAGE

In the event of a total loss to an "auto" for which Comprehensive, Specified Causes of Loss, or Collision coverages are provided under this Coverage Form, then such Physical Damage Coverages are amended to add the following:

In addition to the actual cash value of the "auto", we will pay up to \$1,000 for vinyl vehicle wraps which are displayed on the covered "auto" at the time of total loss. Regardless of the number of autos deemed a total loss, the most we will pay under this Vehicle Wrap Coverage provision for any one "loss" is \$5,000. For purposes of this coverage provision, signs or other graphics painted or magnetically affixed to the vehicle are not considered vehicle wraps.

SPECTRUM POLICY DECLARATIONS (Continued)

POLICY NUMBER: 37 SBA RG7859

LOSS PAYEE 'A':
FORM SS 12 12

PROPERTY:

LENDER'S LOSS PAYABLE 'B':
FORM SS 12 12

PROPERTY:

Form Numbers of Forms and Endorsements that apply:

SS 00 01 03 14	SS 00 05 12 06	SS 00 07 07 05	SS 00 08 04 05
SS 00 64 09 16	SS 84 01 09 07	SS 12 35 03 12	SS 41 70 06 11
SS 41 71 06 11	SS 01 06 07 16	SS 01 07 07 17	SS 01 15 07 08
SS 89 93 07 16	SS 00 60 09 15	SS 00 61 09 15	SS 04 08 09 07
SS 04 13 03 92	SS 04 19 07 05	SS 04 22 07 05	SS 04 30 07 05
SS 04 33 04 05	SS 04 39 07 05	SS 04 41 04 09	SS 04 42 03 17
SS 04 44 07 05	SS 04 45 07 05	SS 04 46 09 14	SS 04 47 04 09
SS 04 80 03 00	SS 04 86 03 00	SS 40 18 07 05	SS 40 93 07 05
SS 41 12 12 07	SS 41 51 10 09	SS 41 63 06 11	IH 10 01 09 86
SS 05 21 04 05	SS 05 47 09 15	SS 50 04 06 04	SS 50 19 01 15
SS 51 10 03 17	SS 51 11 03 17	SS 09 01 12 14	SS 09 07 12 14
SS 09 10 12 14	SS 09 12 12 14	SS 09 67 09 14	SS 09 70 12 14
SS 09 71 12 14	SS 10 18 04 01	SS 12 12 03 92	SS 12 15 03 00
SS 83 47 07 01	IH 99 40 04 09	IH 99 41 04 09	SX 80 01 06 97
SS 83 76 01 15	SS 12 23 06 11		
IH 12 00 11 85	ADDITIONAL INSURED		
IH 12 00 11 85	ADDITIONAL INSURED/LANDLORD		
IH 12 00 11 85	ADDITIONAL INSURED - DESIGNATED PERSON/ORG		
IH 12 00 11 85	ADDITIONAL INSURED - OWNER, LESSEES OR CONTRACTOR-SCHEDULED PERSON OR ORGANIZATION		
IH 12 00 11 85	ADDITIONAL INSURED-OWNERS, LESSEES OR CONTRACTORS -COMPLETED OPERATIONS		

BUSINESS LIABILITY COVERAGE FORM

**QUICK REFERENCE
BUSINESS LIABILITY COVERAGE FORM
READ YOUR POLICY CAREFULLY**

BUSINESS LIABILITY COVERAGE FORM	Beginning on Page
A. COVERAGES	1
Business Liability	1
Medical Expenses	2
Coverage Extension - Supplementary Payments	2
B. EXCLUSIONS	3
C. WHO IS AN INSURED	10
D. LIABILITY AND MEDICAL EXPENSES LIMITS OF INSURANCE	14
E. LIABILITY AND MEDICAL EXPENSES GENERAL CONDITIONS	15
1. Bankruptcy	15
2. Duties In The Event Of Occurrence, Offense, Claim Or Suit	15
3. Financial Responsibility Laws	16
4. Legal Action Against Us	16
5. Separation Of Insureds	16
6. Representations	16
7. Other Insurance	16
8. Transfer Of Rights Of Recovery Against Others To Us	17
F. OPTIONAL ADDITIONAL INSURED COVERAGES	18
Additional Insureds	18
G. LIABILITY AND MEDICAL EXPENSES DEFINITIONS	20



BUSINESS LIABILITY COVERAGE FORM

Various provisions in this policy restrict coverage. Read the entire policy carefully to determine rights, duties and what is and is not covered.

Throughout this policy the words "you" and "your" refer to the Named Insured shown in the Declarations. The words "we", "us" and "our" refer to the stock insurance company member of The Hartford providing this insurance.

The word "insured" means any person or organization qualifying as such under Section **C.** - Who Is An Insured.

Other words and phrases that appear in quotation marks have special meaning. Refer to Section **G.** - Liability And Medical Expenses Definitions.

A. COVERAGES

1. BUSINESS LIABILITY COVERAGE (BODILY INJURY, PROPERTY DAMAGE, PERSONAL AND ADVERTISING INJURY)

Insuring Agreement

- a. We will pay those sums that the insured becomes legally obligated to pay as damages because of "bodily injury", "property damage" or "personal and advertising injury" to which this insurance applies. We will have the right and duty to defend the insured against any "suit" seeking those damages. However, we will have no duty to defend the insured against any "suit" seeking damages for "bodily injury", "property damage" or "personal and advertising injury" to which this insurance does not apply.

We may, at our discretion, investigate any "occurrence" or offense and settle any claim or "suit" that may result. But:

- (1) The amount we will pay for damages is limited as described in Section **D.** - Liability And Medical Expenses Limits Of Insurance; and
- (2) Our right and duty to defend ends when we have used up the applicable limit of insurance in the payment of judgments, settlements or medical expenses to which this insurance applies.

No other obligation or liability to pay sums or perform acts or services is covered unless explicitly provided for under Coverage Extension - Supplementary Payments.

- b. This insurance applies:

- (1) To "bodily injury" and "property damage" only if:

(a) The "bodily injury" or "property damage" is caused by an "occurrence" that takes place in the "coverage territory";

(b) The "bodily injury" or "property damage" occurs during the policy period; and

(c) Prior to the policy period, no insured listed under Paragraph 1. of Section **C.** - Who Is An Insured and no "employee" authorized by you to give or receive notice of an "occurrence" or claim, knew that the "bodily injury" or "property damage" had occurred, in whole or in part. If such a listed insured or authorized "employee" knew, prior to the policy period, that the "bodily injury" or "property damage" occurred, then any continuation, change or resumption of such "bodily injury" or "property damage" during or after the policy period will be deemed to have been known prior to the policy period.

(2) To "personal and advertising injury" caused by an offense arising out of your business, but only if the offense was committed in the "coverage territory" during the policy period.

c. "Bodily injury" or "property damage" will be deemed to have been known to have occurred at the earliest time when any insured listed under Paragraph 1. of Section **C.** - Who Is An Insured or any "employee" authorized by you to give or receive notice of an "occurrence" or claim:

(1) Reports all, or any part, of the "bodily injury" or "property damage" to us or any other insurer;

BUSINESS LIABILITY COVERAGE FORM

- (2) Receives a written or verbal demand or claim for damages because of the "bodily injury" or "property damage"; or
 - (3) Becomes aware by any other means that "bodily injury" or "property damage" has occurred or has begun to occur.
- d. Damages because of "bodily injury" include damages claimed by any person or organization for care, loss of services or death resulting at any time from the "bodily injury".

e. Incidental Medical Malpractice

- (1) "Bodily injury" arising out of the rendering of or failure to render professional health care services as a physician, dentist, nurse, emergency medical technician or paramedic shall be deemed to be caused by an "occurrence", but only if:
 - (a) The physician, dentist, nurse, emergency medical technician or paramedic is employed by you to provide such services; and
 - (b) You are not engaged in the business or occupation of providing such services.
- (2) For the purpose of determining the limits of insurance for incidental medical malpractice, any act or omission together with all related acts or omissions in the furnishing of these services to any one person will be considered one "occurrence".

2. MEDICAL EXPENSES

Insuring Agreement

- a. We will pay medical expenses as described below for "bodily injury" caused by an accident:
 - (1) On premises you own or rent;
 - (2) On ways next to premises you own or rent; or
 - (3) Because of your operations;provided that:
 - (1) The accident takes place in the "coverage territory" and during the policy period;
 - (2) The expenses are incurred and reported to us within three years of the date of the accident; and
 - (3) The injured person submits to examination, at our expense, by physicians of our choice as often as we reasonably require.

- b. We will make these payments regardless of fault. These payments will not exceed the applicable limit of insurance. We will pay reasonable expenses for:

- (1) First aid administered at the time of an accident;
- (2) Necessary medical, surgical, x-ray and dental services, including prosthetic devices; and
- (3) Necessary ambulance, hospital, professional nursing and funeral services.

3. COVERAGE EXTENSION - SUPPLEMENTARY PAYMENTS

- a. We will pay, with respect to any claim or "suit" we investigate or settle, or any "suit" against an insured we defend:
 - (1) All expenses we incur.
 - (2) Up to \$1,000 for the cost of bail bonds required because of accidents or traffic law violations arising out of the use of any vehicle to which Business Liability Coverage for "bodily injury" applies. We do not have to furnish these bonds.
 - (3) The cost of appeal bonds or bonds to release attachments, but only for bond amounts within the applicable limit of insurance. We do not have to furnish these bonds.
 - (4) All reasonable expenses incurred by the insured at our request to assist us in the investigation or defense of the claim or "suit", including actual loss of earnings up to \$500 a day because of time off from work.
 - (5) All costs taxed against the insured in the "suit".
 - (6) Prejudgment interest awarded against the insured on that part of the judgment we pay. If we make an offer to pay the applicable limit of insurance, we will not pay any prejudgment interest based on that period of time after the offer.
 - (7) All interest on the full amount of any judgment that accrues after entry of the judgment and before we have paid, offered to pay, or deposited in court the part of the judgment that is within the applicable limit of insurance.

Any amounts paid under (1) through (7) above will not reduce the limits of insurance.

b. If we defend an insured against a "suit" and an indemnitee of the insured is also named as a party to the "suit", we will defend that indemnitee if all of the following conditions are met:

- (1) The "suit" against the indemnitee seeks damages for which the insured has assumed the liability of the indemnitee in a contract or agreement that is an "insured contract";
- (2) This insurance applies to such liability assumed by the insured;
- (3) The obligation to defend, or the cost of the defense of, that indemnitee, has also been assumed by the insured in the same "insured contract";
- (4) The allegations in the "suit" and the information we know about the "occurrence" are such that no conflict appears to exist between the interests of the insured and the interest of the indemnitee;
- (5) The indemnitee and the insured ask us to conduct and control the defense of that indemnitee against such "suit" and agree that we can assign the same counsel to defend the insured and the indemnitee; and
- (6) The indemnitee:
 - (a) Agrees in writing to:
 - (i) Cooperate with us in the investigation, settlement or defense of the "suit";
 - (ii) Immediately send us copies of any demands, notices, summonses or legal papers received in connection with the "suit";
 - (iii) Notify any other insurer whose coverage is available to the indemnitee; and
 - (iv) Cooperate with us with respect to coordinating other applicable insurance available to the indemnitee; and
 - (b) Provides us with written authorization to:
 - (i) Obtain records and other information related to the "suit"; and
 - (ii) Conduct and control the defense of the indemnitee in such "suit".

So long as the above conditions are met, attorneys' fees incurred by us in the defense of that indemnitee, necessary litigation expenses incurred by us and necessary litigation expenses incurred by the indemnitee at our request will be paid as Supplementary Payments.

Notwithstanding the provisions of Paragraph **1.b.(b)** of Section **B.** – Exclusions, such payments will not be deemed to be damages for "bodily injury" and "property damage" and will not reduce the Limits of Insurance.

Our obligation to defend an insured's indemnitee and to pay for attorneys' fees and necessary litigation expenses as Supplementary Payments ends when:

- (1) We have used up the applicable limit of insurance in the payment of judgments or settlements; or
- (2) The conditions set forth above, or the terms of the agreement described in Paragraph (6) above, are no longer met.

B. EXCLUSIONS

1. Applicable To Business Liability Coverage

This insurance does not apply to:

a. Expected Or Intended Injury

- (1) "Bodily injury" or "property damage" expected or intended from the standpoint of the insured. This exclusion does not apply to "bodily injury" or "property damage" resulting from the use of reasonable force to protect persons or property; or
- (2) "Personal and advertising injury" arising out of an offense committed by, at the direction of or with the consent or acquiescence of the insured with the expectation of inflicting "personal and advertising injury".

b. Contractual Liability

- (1) "Bodily injury" or "property damage"; or
- (2) "Personal and advertising injury"

for which the insured is obligated to pay damages by reason of the assumption of liability in a contract or agreement.

This exclusion does not apply to liability for damages because of:

- (a) "Bodily injury", "property damage" or "personal and advertising injury" that the insured would have in the absence of the contract or agreement; or

BUSINESS LIABILITY COVERAGE FORM

(b) "Bodily injury" or "property damage" assumed in a contract or agreement that is an "insured contract", provided the "bodily injury" or "property damage" occurs subsequent to the execution of the contract or agreement. Solely for the purpose of liability assumed in an "insured contract", reasonable attorneys' fees and necessary litigation expenses incurred by or for a party other than an insured are deemed to be damages because of "bodily injury" or "property damage" provided:

- (i) Liability to such party for, or for the cost of, that party's defense has also been assumed in the same "insured contract", and
- (ii) Such attorneys' fees and litigation expenses are for defense of that party against a civil or alternative dispute resolution proceeding in which damages to which this insurance applies are alleged.

c. Liquor Liability

"Bodily injury" or "property damage" for which any insured may be held liable by reason of:

- (1) Causing or contributing to the intoxication of any person;
- (2) The furnishing of alcoholic beverages to a person under the legal drinking age or under the influence of alcohol; or
- (3) Any statute, ordinance or regulation relating to the sale, gift, distribution or use of alcoholic beverages.

This exclusion applies only if you are in the business of manufacturing, distributing, selling, serving or furnishing alcoholic beverages.

d. Workers' Compensation And Similar Laws

Any obligation of the insured under a workers' compensation, disability benefits or unemployment compensation law or any similar law.

e. Employer's Liability

"Bodily injury" to:

- (1) An "employee" of the insured arising out of and in the course of:
 - (a) Employment by the insured; or

(b) Performing duties related to the conduct of the insured's business, or

- (2) The spouse, child, parent, brother or sister of that "employee" as a consequence of (1) above.

This exclusion applies:

- (1) Whether the insured may be liable as an employer or in any other capacity; and
- (2) To any obligation to share damages with or repay someone else who must pay damages because of the injury.

This exclusion does not apply to liability assumed by the insured under an "insured contract".

f. Pollution

- (1) "Bodily injury", "property damage" or "personal and advertising injury" arising out of the actual, alleged or threatened discharge, dispersal, seepage, migration, release or escape of "pollutants":

(a) At or from any premises, site or location which is or was at any time owned or occupied by, or rented or loaned to any insured. However, this subparagraph does not apply to:

- (i) "Bodily injury" if sustained within a building and caused by smoke, fumes, vapor or soot produced by or originating from equipment that is used to heat, cool or dehumidify the building, or equipment that is used to heat water for personal use, by the building's occupants or their guests;

- (ii) "Bodily injury" or "property damage" for which you may be held liable, if you are a contractor and the owner or lessee of such premises, site or location has been added to your policy as an additional insured with respect to your ongoing operations performed for that additional insured at that premises, site or location and such premises, site or location is not and never was owned or occupied by, or rented or loaned to, any insured, other than that additional insured; or

- (iii) "Bodily injury" or "property damage" arising out of heat, smoke or fumes from a "hostile fire";
 - (b) At or from any premises, site or location which is or was at any time used by or for any insured or others for the handling, storage, disposal, processing or treatment of waste;
 - (c) Which are or were at any time transported, handled, stored, treated, disposed of, or processed as waste by or for:
 - (i) Any insured; or
 - (ii) Any person or organization for whom you may be legally responsible;
 - (d) At or from any premises, site or location on which any insured or any contractors or subcontractors working directly or indirectly on any insured's behalf are performing operations if the "pollutants" are brought on or to the premises, site or location in connection with such operations by such insured, contractor or subcontractor. However, this subparagraph does not apply to:
 - (i) "Bodily injury" or "property damage" arising out of the escape of fuels, lubricants or other operating fluids which are needed to perform the normal electrical, hydraulic or mechanical functions necessary for the operation of "mobile equipment" or its parts, if such fuels, lubricants or other operating fluids escape from a vehicle part designed to hold, store or receive them. This exception does not apply if the "bodily injury" or "property damage" arises out of the intentional discharge, dispersal or release of the fuels, lubricants or other operating fluids, or if such fuels, lubricants or other operating fluids are brought on or to the premises, site or location with the intent that they be discharged, dispersed or released as part of the operations being performed by such insured, contractor or subcontractor;
 - (ii) "Bodily injury" or "property damage" sustained within a building and caused by the release of gases, fumes or vapors from materials brought into that building in connection with operations being performed by you or on your behalf by a contractor or subcontractor; or
 - (iii) "Bodily injury" or "property damage" arising out of heat, smoke or fumes from a "hostile fire"; or
 - (e) At or from any premises, site or location on which any insured or any contractors or subcontractors working directly or indirectly on any insured's behalf are performing operations if the operations are to test for, monitor, clean up, remove, contain, treat, detoxify or neutralize, or in any way respond to, or assess the effects of, "pollutants".
- (2) Any loss, cost or expense arising out of any:
- (a) Request, demand, order or statutory or regulatory requirement that any insured or others test for, monitor, clean up, remove, contain, treat, detoxify or neutralize, or in any way respond to, or assess the effects of, "pollutants"; or
 - (b) Claim or suit by or on behalf of a governmental authority for damages because of testing for, monitoring, cleaning up, removing, containing, treating, detoxifying or neutralizing, or in any way responding to, or assessing the effects of, "pollutants".
- However, this paragraph does not apply to liability for damages because of "property damage" that the insured would have in the absence of such request, demand, order or statutory or regulatory requirement, or such claim or "suit" by or on behalf of a governmental authority.

BUSINESS LIABILITY COVERAGE FORM

g. Aircraft, Auto Or Watercraft

"Bodily injury" or "property damage" arising out of the ownership, maintenance, use or entrustment to others of any aircraft, "auto" or watercraft owned or operated by or rented or loaned to any insured. Use includes operation and "loading or unloading".

This exclusion applies even if the claims against any insured allege negligence or other wrongdoing in the supervision, hiring, employment, training or monitoring of others by that insured, if the "occurrence" which caused the "bodily injury" or "property damage" involved the ownership, maintenance, use or entrustment to others of any aircraft, "auto" or watercraft that is owned or operated by or rented or loaned to any insured.

This exclusion does not apply to:

- (1) A watercraft while ashore on premises you own or rent;
- (2) A watercraft you do not own that is:
 - (a) Less than 51 feet long; and
 - (b) Not being used to carry persons for a charge;
- (3) Parking an "auto" on, or on the ways next to, premises you own or rent, provided the "auto" is not owned by or rented or loaned to you or the insured;
- (4) Liability assumed under any "insured contract" for the ownership, maintenance or use of aircraft or watercraft;
- (5) "Bodily injury" or "property damage" arising out of the operation of any of the equipment listed in Paragraph **f.(2)** or **f.(3)** of the definition of "mobile equipment"; or
- (6) An aircraft that is not owned by any insured and is hired, chartered or loaned with a paid crew. However, this exception does not apply if the insured has any other insurance for such "bodily injury" or "property damage", whether the other insurance is primary, excess, contingent or on any other basis.

h. Mobile Equipment

"Bodily injury" or "property damage" arising out of:

- (1) The transportation of "mobile equipment" by an "auto" owned or operated by or rented or loaned to any insured; or

- (2) The use of "mobile equipment" in, or while in practice or preparation for, a prearranged racing, speed or demolition contest or in any stunting activity.

i. War

"Bodily injury", "property damage" or "personal and advertising injury", however caused, arising, directly or indirectly, out of:

- (1) War, including undeclared or civil war;
- (2) Warlike action by a military force, including action in hindering or defending against an actual or expected attack, by any government, sovereign or other authority using military personnel or other agents; or
- (3) Insurrection, rebellion, revolution, usurped power, or action taken by governmental authority in hindering or defending against any of these.

j. Professional Services

"Bodily injury", "property damage" or "personal and advertising injury" arising out of the rendering of or failure to render any professional service. This includes but is not limited to:

- (1) Legal, accounting or advertising services;
- (2) Preparing, approving, or failing to prepare or approve maps, shop drawings, opinions, reports, surveys, field orders, change orders, designs or drawings and specifications;
- (3) Supervisory, inspection, architectural or engineering activities;
- (4) Medical, surgical, dental, x-ray or nursing services treatment, advice or instruction;
- (5) Any health or therapeutic service treatment, advice or instruction;
- (6) Any service, treatment, advice or instruction for the purpose of appearance or skin enhancement, hair removal or replacement or personal grooming;
- (7) Optical or hearing aid services including the prescribing, preparation, fitting, demonstration or distribution of ophthalmic lenses and similar products or hearing aid devices;

- (8) Optometry or optometric services including but not limited to examination of the eyes and the prescribing, preparation, fitting, demonstration or distribution of ophthalmic lenses and similar products;
- (9) Any:
 - (a) Body piercing (not including ear piercing);
 - (b) Tattooing, including but not limited to the insertion of pigments into or under the skin; and
 - (c) Similar services;
- (10) Services in the practice of pharmacy; and
- (11) Computer consulting, design or programming services, including web site design.

Paragraphs (4) and (5) of this exclusion do not apply to the Incidental Medical Malpractice coverage afforded under Paragraph 1.e. in Section A. - Coverages.

k. Damage To Property

"Property damage" to:

- (1) Property you own, rent or occupy, including any costs or expenses incurred by you, or any other person, organization or entity, for repair, replacement, enhancement, restoration or maintenance of such property for any reason, including prevention of injury to a person or damage to another's property;
- (2) Premises you sell, give away or abandon, if the "property damage" arises out of any part of those premises;
- (3) Property loaned to you;
- (4) Personal property in the care, custody or control of the insured;
- (5) That particular part of real property on which you or any contractors or subcontractors working directly or indirectly on your behalf are performing operations, if the "property damage" arises out of those operations; or
- (6) That particular part of any property that must be restored, repaired or replaced because "your work" was incorrectly performed on it.

Paragraphs (1), (3) and (4) of this exclusion do not apply to "property damage" (other than damage by fire) to premises, including the contents of such premises, rented to you for a period of 7 or fewer consecutive days. A separate Limit of Insurance applies to Damage To Premises Rented To You as described in Section D. - Limits Of Insurance.

Paragraph (2) of this exclusion does not apply if the premises are "your work" and were never occupied, rented or held for rental by you.

Paragraphs (3) and (4) of this exclusion do not apply to the use of elevators.

Paragraphs (3), (4), (5) and (6) of this exclusion do not apply to liability assumed under a sidetrack agreement.

Paragraphs (3) and (4) of this exclusion do not apply to "property damage" to borrowed equipment while not being used to perform operations at a job site.

Paragraph (6) of this exclusion does not apply to "property damage" included in the "products-completed operations hazard".

l. Damage To Your Product

"Property damage" to "your product" arising out of it or any part of it.

m. Damage To Your Work

"Property damage" to "your work" arising out of it or any part of it and included in the "products-completed operations hazard".

This exclusion does not apply if the damaged work or the work out of which the damage arises was performed on your behalf by a subcontractor.

n. Damage To Impaired Property Or Property Not Physically Injured

"Property damage" to "impaired property" or property that has not been physically injured, arising out of:

- (1) A defect, deficiency, inadequacy or dangerous condition in "your product" or "your work"; or
- (2) A delay or failure by you or anyone acting on your behalf to perform a contract or agreement in accordance with its terms.

This exclusion does not apply to the loss of use of other property arising out of sudden and accidental physical injury to "your product" or "your work" after it has been put to its intended use.

BUSINESS LIABILITY COVERAGE FORM

o. Recall Of Products, Work Or Impaired Property

Damages claimed for any loss, cost or expense incurred by you or others for the loss of use, withdrawal, recall, inspection, repair, replacement, adjustment, removal or disposal of:

- (1) "Your product";
- (2) "Your work"; or
- (3) "Impaired property";

if such product, work or property is withdrawn or recalled from the market or from use by any person or organization because of a known or suspected defect, deficiency, inadequacy or dangerous condition in it.

p. Personal And Advertising Injury

"Personal and advertising injury":

- (1) Arising out of oral, written or electronic publication of material, if done by or at the direction of the insured with knowledge of its falsity;
- (2) Arising out of oral, written or electronic publication of material whose first publication took place before the beginning of the policy period;
- (3) Arising out of a criminal act committed by or at the direction of the insured;
- (4) Arising out of any breach of contract, except an implied contract to use another's "advertising idea" in your "advertisement";
- (5) Arising out of the failure of goods, products or services to conform with any statement of quality or performance made in your "advertisement";
- (6) Arising out of the wrong description of the price of goods, products or services;
- (7) Arising out of any violation of any intellectual property rights such as copyright, patent, trademark, trade name, trade secret, service mark or other designation of origin or authenticity.

However, this exclusion does not apply to infringement, in your "advertisement", of

- (a) Copyright;
- (b) Slogan, unless the slogan is also a trademark, trade name, service mark or other designation of origin or authenticity; or

(c) Title of any literary or artistic work;

- (8) Arising out of an offense committed by an insured whose business is:
 - (a) Advertising, broadcasting, publishing or telecasting;
 - (b) Designing or determining content of web sites for others; or
 - (c) An Internet search, access, content or service provider.

However, this exclusion does not apply to Paragraphs **a.**, **b.** and **c.** under the definition of "personal and advertising injury" in Section **G.** – Liability And Medical Expenses Definitions.

For the purposes of this exclusion, placing an "advertisement" for or linking to others on your web site, by itself, is not considered the business of advertising, broadcasting, publishing or telecasting;

- (9) Arising out of an electronic chat room or bulletin board the insured hosts, owns, or over which the insured exercises control;
- (10) Arising out of the unauthorized use of another's name or product in your e-mail address, domain name or metatags, or any other similar tactics to mislead another's potential customers;
- (11) Arising out of the violation of a person's right of privacy created by any state or federal act.

However, this exclusion does not apply to liability for damages that the insured would have in the absence of such state or federal act;

- (12) Arising out of:
 - (a) An "advertisement" for others on your web site;
 - (b) Placing a link to a web site of others on your web site;
 - (c) Content from a web site of others displayed within a frame or border on your web site. Content includes information, code, sounds, text, graphics or images; or
 - (d) Computer code, software or programming used to enable:
 - (i) Your web site; or
 - (ii) The presentation or functionality of an "advertisement" or other content on your web site;

- (13) Arising out of a violation of any anti-trust law;
- (14) Arising out of the fluctuation in price or value of any stocks, bonds or other securities; or
- (15) Arising out of discrimination or humiliation committed by or at the direction of any "executive officer", director, stockholder, partner or member of the insured.

q. Electronic Data

Damages arising out of the loss of, loss of use of, damage to, corruption of, inability to access, or inability to manipulate "electronic data".

r. Employment-Related Practices

"Bodily injury" or "personal and advertising injury" to:

- (1) A person arising out of any:
 - (a) Refusal to employ that person;
 - (b) Termination of that person's employment; or
 - (c) Employment-related practices, policies, acts or omissions, such as coercion, demotion, evaluation, reassignment, discipline, defamation, harassment, humiliation or discrimination directed at that person; or
- (2) The spouse, child, parent, brother or sister of that person as a consequence of "bodily injury" or "personal and advertising injury" to the person at whom any of the employment-related practices described in Paragraphs (a), (b), or (c) above is directed.

This exclusion applies:

- (1) Whether the insured may be liable as an employer or in any other capacity; and
- (2) To any obligation to share damages with or repay someone else who must pay damages because of the injury.

s. Asbestos

- (1) "Bodily injury", "property damage" or "personal and advertising injury" arising out of the "asbestos hazard".
- (2) Any damages, judgments, settlements, loss, costs or expenses that:

- (a) May be awarded or incurred by reason of any claim or suit alleging actual or threatened injury or damage of any nature or kind to persons or property which would not have occurred in whole or in part but for the "asbestos hazard";
- (b) Arise out of any request, demand, order or statutory or regulatory requirement that any insured or others test for, monitor, clean up, remove, encapsulate, contain, treat, detoxify or neutralize or in any way respond to or assess the effects of an "asbestos hazard"; or
- (c) Arise out of any claim or suit for damages because of testing for, monitoring, cleaning up, removing, encapsulating, containing, treating, detoxifying or neutralizing or in any way responding to or assessing the effects of an "asbestos hazard".

t. Violation Of Statutes That Govern E-Mails, Fax, Phone Calls Or Other Methods Of Sending Material Or Information

"Bodily injury", "property damage", or "personal and advertising injury" arising directly or indirectly out of any action or omission that violates or is alleged to violate:

- (1) The Telephone Consumer Protection Act (TCPA), including any amendment of or addition to such law;
- (2) The CAN-SPAM Act of 2003, including any amendment of or addition to such law; or
- (3) Any statute, ordinance or regulation, other than the TCPA or CAN-SPAM Act of 2003, that prohibits or limits the sending, transmitting, communicating or distribution of material or information.

Damage To Premises Rented To You – Exception For Damage By Fire, Lightning or Explosion

Exclusions **c.** through **h.** and **k.** through **o.** do not apply to damage by fire, lightning or explosion to premises rented to you or temporarily occupied by you with permission of the owner. A separate Limit of Insurance applies to this coverage as described in Section **D.** - Liability And Medical Expenses Limits Of Insurance.

BUSINESS LIABILITY COVERAGE FORM

2. Applicable To Medical Expenses Coverage

We will not pay expenses for "bodily injury":

a. Any Insured

To any insured, except "volunteer workers".

b. Hired Person

To a person hired to do work for or on behalf of any insured or a tenant of any insured.

c. Injury On Normally Occupied Premises

To a person injured on that part of premises you own or rent that the person normally occupies.

d. Workers' Compensation And Similar Laws

To a person, whether or not an "employee" of any insured, if benefits for the "bodily injury" are payable or must be provided under a workers' compensation or disability benefits law or a similar law.

e. Athletics Activities

To a person injured while practicing, instructing or participating in any physical exercises or games, sports or athletic contests.

f. Products-Completed Operations Hazard

Included with the "products-completed operations hazard".

g. Business Liability Exclusions

Excluded under Business Liability Coverage.

C. WHO IS AN INSURED

1. If you are designated in the Declarations as:

- a. An individual, you and your spouse are insureds, but only with respect to the conduct of a business of which you are the sole owner.
- b. A partnership or joint venture, you are an insured. Your members, your partners, and their spouses are also insureds, but only with respect to the conduct of your business.
- c. A limited liability company, you are an insured. Your members are also insureds, but only with respect to the conduct of your business. Your managers are insureds, but only with respect to their duties as your managers.
- d. An organization other than a partnership, joint venture or limited liability company, you are an insured. Your "executive officers" and directors are insureds, but only with respect to their duties as your officers or directors. Your stockholders are also insureds, but only with respect to their liability as stockholders.

e. A trust, you are an insured. Your trustees are also insureds, but only with respect to their duties as trustees.

2. Each of the following is also an insured:

a. Employees And Volunteer Workers

Your "volunteer workers" only while performing duties related to the conduct of your business, or your "employees", other than either your "executive officers" (if you are an organization other than a partnership, joint venture or limited liability company) or your managers (if you are a limited liability company), but only for acts within the scope of their employment by you or while performing duties related to the conduct of your business.

However, none of these "employees" or "volunteer workers" are insureds for:

(1) "Bodily injury" or "personal and advertising injury":

- (a) To you, to your partners or members (if you are a partnership or joint venture), to your members (if you are a limited liability company), or to a co-"employee" while in the course of his or her employment or performing duties related to the conduct of your business, or to your other "volunteer workers" while performing duties related to the conduct of your business;
- (b) To the spouse, child, parent, brother or sister of that co-"employee" or that "volunteer worker" as a consequence of Paragraph (1)(a) above;
- (c) For which there is any obligation to share damages with or repay someone else who must pay damages because of the injury described in Paragraphs (1)(a) or (b) above; or
- (d) Arising out of his or her providing or failing to provide professional health care services.

If you are not in the business of providing professional health care services, Paragraph (d) does not apply to any nurse, emergency medical technician or paramedic employed by you to provide such services.

(2) "Property damage" to property:

- (a) Owned, occupied or used by,

(b) Rented to, in the care, custody or control of, or over which physical control is being exercised for any purpose by you, any of your "employees", "volunteer workers", any partner or member (if you are a partnership or joint venture), or any member (if you are a limited liability company).

b. Real Estate Manager

Any person (other than your "employee" or "volunteer worker"), or any organization while acting as your real estate manager.

c. Temporary Custodians Of Your Property

Any person or organization having proper temporary custody of your property if you die, but only:

- (1) With respect to liability arising out of the maintenance or use of that property; and
- (2) Until your legal representative has been appointed.

d. Legal Representative If You Die

Your legal representative if you die, but only with respect to duties as such. That representative will have all your rights and duties under this insurance.

e. Unnamed Subsidiary

Any subsidiary and subsidiary thereof, of yours which is a legally incorporated entity of which you own a financial interest of more than 50% of the voting stock on the effective date of this Coverage Part.

The insurance afforded herein for any subsidiary not shown in the Declarations as a named insured does not apply to injury or damage with respect to which an insured under this insurance is also an insured under another policy or would be an insured under such policy but for its termination or upon the exhaustion of its limits of insurance.

3. Newly Acquired Or Formed Organization

Any organization you newly acquire or form, other than a partnership, joint venture or limited liability company, and over which you maintain financial interest of more than 50% of the voting stock, will qualify as a Named Insured if there is no other similar insurance available to that organization. However:

- a. Coverage under this provision is afforded only until the 180th day after you acquire or form the organization or the end of the policy period, whichever is earlier; and

b. Coverage under this provision does not apply to:

- (1) "Bodily injury" or "property damage" that occurred; or
- (2) "Personal and advertising injury" arising out of an offense committed before you acquired or formed the organization.

4. Operator Of Mobile Equipment

With respect to "mobile equipment" registered in your name under any motor vehicle registration law, any person is an insured while driving such equipment along a public highway with your permission. Any other person or organization responsible for the conduct of such person is also an insured, but only with respect to liability arising out of the operation of the equipment, and only if no other insurance of any kind is available to that person or organization for this liability. However, no person or organization is an insured with respect to:

- a. "Bodily injury" to a co-"employee" of the person driving the equipment; or
- b. "Property damage" to property owned by, rented to, in the charge of or occupied by you or the employer of any person who is an insured under this provision.

5. Operator of Nonowned Watercraft

With respect to watercraft you do not own that is less than 51 feet long and is not being used to carry persons for a charge, any person is an insured while operating such watercraft with your permission. Any other person or organization responsible for the conduct of such person is also an insured, but only with respect to liability arising out of the operation of the watercraft, and only if no other insurance of any kind is available to that person or organization for this liability.

However, no person or organization is an insured with respect to:

- a. "Bodily injury" to a co-"employee" of the person operating the watercraft; or
- b. "Property damage" to property owned by, rented to, in the charge of or occupied by you or the employer of any person who is an insured under this provision.

6. Additional Insureds When Required By Written Contract, Written Agreement Or Permit

The person(s) or organization(s) identified in Paragraphs a. through f. below are additional insureds when you have agreed, in a written

BUSINESS LIABILITY COVERAGE FORM

contract, written agreement or because of a permit issued by a state or political subdivision, that such person or organization be added as an additional insured on your policy, provided the injury or damage occurs subsequent to the execution of the contract or agreement, or the issuance of the permit.

A person or organization is an additional insured under this provision only for that period of time required by the contract, agreement or permit.

However, no such person or organization is an additional insured under this provision if such person or organization is included as an additional insured by an endorsement issued by us and made a part of this Coverage Part, including all persons or organizations added as additional insureds under the specific additional insured coverage grants in Section F. – Optional Additional Insured Coverages.

a. Vendors

Any person(s) or organization(s) (referred to below as vendor), but only with respect to "bodily injury" or "property damage" arising out of "your products" which are distributed or sold in the regular course of the vendor's business and only if this Coverage Part provides coverage for "bodily injury" or "property damage" included within the "products-completed operations hazard".

- (1) The insurance afforded to the vendor is subject to the following additional exclusions:

This insurance does not apply to:

- (a) "Bodily injury" or "property damage" for which the vendor is obligated to pay damages by reason of the assumption of liability in a contract or agreement. This exclusion does not apply to liability for damages that the vendor would have in the absence of the contract or agreement;
- (b) Any express warranty unauthorized by you;
- (c) Any physical or chemical change in the product made intentionally by the vendor;
- (d) Repackaging, except when unpacked solely for the purpose of inspection, demonstration, testing, or the substitution of parts under instructions from the manufacturer, and then repackaged in the original container;

(e) Any failure to make such inspections, adjustments, tests or servicing as the vendor has agreed to make or normally undertakes to make in the usual course of business, in connection with the distribution or sale of the products;

(f) Demonstration, installation, servicing or repair operations, except such operations performed at the vendor's premises in connection with the sale of the product;

(g) Products which, after distribution or sale by you, have been labeled or relabeled or used as a container, part or ingredient of any other thing or substance by or for the vendor; or

(h) "Bodily injury" or "property damage" arising out of the sole negligence of the vendor for its own acts or omissions or those of its employees or anyone else acting on its behalf. However, this exclusion does not apply to:

(i) The exceptions contained in Subparagraphs (d) or (f); or

(ii) Such inspections, adjustments, tests or servicing as the vendor has agreed to make or normally undertakes to make in the usual course of business, in connection with the distribution or sale of the products.

- (2) This insurance does not apply to any insured person or organization from whom you have acquired such products, or any ingredient, part or container, entering into, accompanying or containing such products.

b. Lessors Of Equipment

- (1) Any person or organization from whom you lease equipment; but only with respect to their liability for "bodily injury", "property damage" or "personal and advertising injury" caused, in whole or in part, by your maintenance, operation or use of equipment leased to you by such person or organization.

- (2) With respect to the insurance afforded to these additional insureds, this insurance does not apply to any "occurrence" which takes place after you cease to lease that equipment.

c. Lessors Of Land Or Premises

- (1) Any person or organization from whom you lease land or premises, but only with respect to liability arising out of the ownership, maintenance or use of that part of the land or premises leased to you.
- (2) With respect to the insurance afforded to these additional insureds, this insurance does not apply to:
 - (a) Any "occurrence" which takes place after you cease to lease that land or be a tenant in that premises; or
 - (b) Structural alterations, new construction or demolition operations performed by or on behalf of such person or organization.

d. Architects, Engineers Or Surveyors

- (1) Any architect, engineer, or surveyor, but only with respect to liability for "bodily injury", "property damage" or "personal and advertising injury" caused, in whole or in part, by your acts or omissions or the acts or omissions of those acting on your behalf:
 - (a) In connection with your premises; or
 - (b) In the performance of your ongoing operations performed by you or on your behalf.
- (2) With respect to the insurance afforded to these additional insureds, the following additional exclusion applies:

This insurance does not apply to "bodily injury", "property damage" or "personal and advertising injury" arising out of the rendering of or the failure to render any professional services by or for you, including:

 - (a) The preparing, approving, or failure to prepare or approve, maps, shop drawings, opinions, reports, surveys, field orders, change orders, designs or drawings and specifications; or
 - (b) Supervisory, inspection, architectural or engineering activities.

e. Permits Issued By State Or Political Subdivisions

- (1) Any state or political subdivision, but only with respect to operations performed by you or on your behalf for which the state or political subdivision has issued a permit.
- (2) With respect to the insurance afforded to these additional insureds, this insurance does not apply to:
 - (a) "Bodily injury", "property damage" or "personal and advertising injury" arising out of operations performed for the state or municipality; or
 - (b) "Bodily injury" or "property damage" included within the "products-completed operations hazard".

f. Any Other Party

- (1) Any other person or organization who is not an insured under Paragraphs **a.** through **e.** above, but only with respect to liability for "bodily injury", "property damage" or "personal and advertising injury" caused, in whole or in part, by your acts or omissions or the acts or omissions of those acting on your behalf:
 - (a) In the performance of your ongoing operations;
 - (b) In connection with your premises owned by or rented to you; or
 - (c) In connection with "your work" and included within the "products-completed operations hazard", but only if
 - (i) The written contract or written agreement requires you to provide such coverage to such additional insured; and
 - (ii) This Coverage Part provides coverage for "bodily injury" or "property damage" included within the "products-completed operations hazard".
- (2) With respect to the insurance afforded to these additional insureds, this insurance does not apply to:

"Bodily injury", "property damage" or "personal and advertising injury" arising out of the rendering of, or the failure to render, any professional architectural, engineering or surveying services, including:

BUSINESS LIABILITY COVERAGE FORM

- (a) The preparing, approving, or failure to prepare or approve, maps, shop drawings, opinions, reports, surveys, field orders, change orders, designs or drawings and specifications; or
- (b) Supervisory, inspection, architectural or engineering activities.

The limits of insurance that apply to additional insureds are described in Section **D. – Limits Of Insurance**.

How this insurance applies when other insurance is available to an additional insured is described in the Other Insurance Condition in Section **E. – Liability And Medical Expenses General Conditions**.

No person or organization is an insured with respect to the conduct of any current or past partnership, joint venture or limited liability company that is not shown as a Named Insured in the Declarations.

D. LIABILITY AND MEDICAL EXPENSES LIMITS OF INSURANCE

1. The Most We Will Pay

The Limits of Insurance shown in the Declarations and the rules below fix the most we will pay regardless of the number of:

- a. Insureds;
- b. Claims made or "suits" brought; or
- c. Persons or organizations making claims or bringing "suits".

2. Aggregate Limits

The most we will pay for:

- a. Damages because of "bodily injury" and "property damage" included in the "products-completed operations hazard" is the Products-Completed Operations Aggregate Limit shown in the Declarations.
- b. Damages because of all other "bodily injury", "property damage" or "personal and advertising injury", including medical expenses, is the General Aggregate Limit shown in the Declarations.

This General Aggregate Limit applies separately to each of your "locations" owned by or rented to you.

"Location" means premises involving the same or connecting lots, or premises whose connection is interrupted only by a street, roadway or right-of-way of a railroad.

This General Aggregate limit does not apply to "property damage" to premises while rented to you or temporarily occupied by you with permission of the owner, arising out of fire, lightning or explosion.

3. Each Occurrence Limit

Subject to **2.a.** or **2.b.** above, whichever applies, the most we will pay for the sum of all damages because of all "bodily injury", "property damage" and medical expenses arising out of any one "occurrence" is the Liability and Medical Expenses Limit shown in the Declarations.

The most we will pay for all medical expenses because of "bodily injury" sustained by any one person is the Medical Expenses Limit shown in the Declarations.

4. Personal And Advertising Injury Limit

Subject to **2.b.** above, the most we will pay for the sum of all damages because of all "personal and advertising injury" sustained by any one person or organization is the Personal and Advertising Injury Limit shown in the Declarations.

5. Damage To Premises Rented To You Limit

The Damage To Premises Rented To You Limit is the most we will pay under Business Liability Coverage for damages because of "property damage" to any one premises, while rented to you, or in the case of damage by fire, lightning or explosion, while rented to you or temporarily occupied by you with permission of the owner.

In the case of damage by fire, lightning or explosion, the Damage to Premises Rented To You Limit applies to all damage proximately caused by the same event, whether such damage results from fire, lightning or explosion or any combination of these.

6. How Limits Apply To Additional Insureds

The most we will pay on behalf of a person or organization who is an additional insured under this Coverage Part is the lesser of:

- a. The limits of insurance specified in a written contract, written agreement or permit issued by a state or political subdivision; or
- b. The Limits of Insurance shown in the Declarations.

Such amount shall be a part of and not in addition to the Limits of Insurance shown in the Declarations and described in this Section.

If more than one limit of insurance under this policy and any endorsements attached thereto applies to any claim or "suit", the most we will pay under this policy and the endorsements is the single highest limit of liability of all coverages applicable to such claim or "suit". However, this paragraph does not apply to the Medical Expenses limit set forth in Paragraph 3. above.

The Limits of Insurance of this Coverage Part apply separately to each consecutive annual period and to any remaining period of less than 12 months, starting with the beginning of the policy period shown in the Declarations, unless the policy period is extended after issuance for an additional period of less than 12 months. In that case, the additional period will be deemed part of the last preceding period for purposes of determining the Limits of Insurance.

**E. LIABILITY AND MEDICAL EXPENSES
GENERAL CONDITIONS**

1. Bankruptcy

Bankruptcy or insolvency of the insured or of the insured's estate will not relieve us of our obligations under this Coverage Part.

2. Duties In The Event Of Occurrence, Offense, Claim Or Suit

a. Notice Of Occurrence Or Offense

You or any additional insured must see to it that we are notified as soon as practicable of an "occurrence" or an offense which may result in a claim. To the extent possible, notice should include:

- (1) How, when and where the "occurrence" or offense took place;
- (2) The names and addresses of any injured persons and witnesses; and
- (3) The nature and location of any injury or damage arising out of the "occurrence" or offense.

b. Notice Of Claim

If a claim is made or "suit" is brought against any insured, you or any additional insured must:

- (1) Immediately record the specifics of the claim or "suit" and the date received; and
- (2) Notify us as soon as practicable.

You or any additional insured must see to it that we receive a written notice of the claim or "suit" as soon as practicable.

c. Assistance And Cooperation Of The Insured

You and any other involved insured must:

- (1) Immediately send us copies of any demands, notices, summonses or legal papers received in connection with the claim or "suit";
- (2) Authorize us to obtain records and other information;
- (3) Cooperate with us in the investigation, settlement of the claim or defense against the "suit"; and
- (4) Assist us, upon our request, in the enforcement of any right against any person or organization that may be liable to the insured because of injury or damage to which this insurance may also apply.

d. Obligations At The Insured's Own Cost

No insured will, except at that insured's own cost, voluntarily make a payment, assume any obligation, or incur any expense, other than for first aid, without our consent.

e. Additional Insured's Other Insurance

If we cover a claim or "suit" under this Coverage Part that may also be covered by other insurance available to an additional insured, such additional insured must submit such claim or "suit" to the other insurer for defense and indemnity.

However, this provision does not apply to the extent that you have agreed in a written contract, written agreement or permit that this insurance is primary and non-contributory with the additional insured's own insurance.

f. Knowledge Of An Occurrence, Offense, Claim Or Suit

Paragraphs a. and b. apply to you or to any additional insured only when such "occurrence", offense, claim or "suit" is known to:

- (1) You or any additional insured that is an individual;
- (2) Any partner, if you or an additional insured is a partnership;
- (3) Any manager, if you or an additional insured is a limited liability company;
- (4) Any "executive officer" or insurance manager, if you or an additional insured is a corporation;
- (5) Any trustee, if you or an additional insured is a trust; or
- (6) Any elected or appointed official, if you or an additional insured is a political subdivision or public entity.

BUSINESS LIABILITY COVERAGE FORM

This Paragraph f. applies separately to you and any additional insured.

3. Financial Responsibility Laws

- a. When this policy is certified as proof of financial responsibility for the future under the provisions of any motor vehicle financial responsibility law, the insurance provided by the policy for "bodily injury" liability and "property damage" liability will comply with the provisions of the law to the extent of the coverage and limits of insurance required by that law.
- b. With respect to "mobile equipment" to which this insurance applies, we will provide any liability, uninsured motorists, underinsured motorists, no-fault or other coverage required by any motor vehicle law. We will provide the required limits for those coverages.

4. Legal Action Against Us

No person or organization has a right under this Coverage Form:

- a. To join us as a party or otherwise bring us into a "suit" asking for damages from an insured; or
- b. To sue us on this Coverage Form unless all of its terms have been fully complied with.

A person or organization may sue us to recover on an agreed settlement or on a final judgment against an insured; but we will not be liable for damages that are not payable under the terms of this insurance or that are in excess of the applicable limit of insurance. An agreed settlement means a settlement and release of liability signed by us, the insured and the claimant or the claimant's legal representative.

5. Separation Of Insureds

Except with respect to the Limits of Insurance, and any rights or duties specifically assigned in this policy to the first Named Insured, this insurance applies:

- a. As if each Named Insured were the only Named Insured; and
- b. Separately to each insured against whom a claim is made or "suit" is brought.

6. Representations

a. When You Accept This Policy

By accepting this policy, you agree:

- (1) The statements in the Declarations are accurate and complete;
- (2) Those statements are based upon representations you made to us; and

- (3) We have issued this policy in reliance upon your representations.

b. Unintentional Failure To Disclose Hazards

If unintentionally you should fail to disclose all hazards relating to the conduct of your business at the inception date of this Coverage Part, we shall not deny any coverage under this Coverage Part because of such failure.

7. Other Insurance

If other valid and collectible insurance is available for a loss we cover under this Coverage Part, our obligations are limited as follows:

a. Primary Insurance

This insurance is primary except when b. below applies. If other insurance is also primary, we will share with all that other insurance by the method described in c. below.

b. Excess Insurance

This insurance is excess over any of the other insurance, whether primary, excess, contingent or on any other basis:

(1) Your Work

That is Fire, Extended Coverage, Builder's Risk, Installation Risk or similar coverage for "your work";

(2) Premises Rented To You

That is fire, lightning or explosion insurance for premises rented to you or temporarily occupied by you with permission of the owner;

(3) Tenant Liability

That is insurance purchased by you to cover your liability as a tenant for "property damage" to premises rented to you or temporarily occupied by you with permission of the owner;

(4) Aircraft, Auto Or Watercraft

If the loss arises out of the maintenance or use of aircraft, "autos" or watercraft to the extent not subject to Exclusion g. of Section A. – Coverages.

(5) Property Damage To Borrowed Equipment Or Use Of Elevators

If the loss arises out of "property damage" to borrowed equipment or the use of elevators to the extent not subject to Exclusion k. of Section A. – Coverages.

(6) When You Are Added As An Additional Insured To Other Insurance

That is other insurance available to you covering liability for damages arising out of the premises or operations, or products and completed operations, for which you have been added as an additional insured by that insurance; or

(7) When You Add Others As An Additional Insured To This Insurance

That is other insurance available to an additional insured.

However, the following provisions apply to other insurance available to any person or organization who is an additional insured under this Coverage Part:

(a) Primary Insurance When Required By Contract

This insurance is primary if you have agreed in a written contract, written agreement or permit that this insurance be primary. If other insurance is also primary, we will share with all that other insurance by the method described in **c.** below.

(b) Primary And Non-Contributory To Other Insurance When Required By Contract

If you have agreed in a written contract, written agreement or permit that this insurance is primary and non-contributory with the additional insured's own insurance, this insurance is primary and we will not seek contribution from that other insurance.

Paragraphs **(a)** and **(b)** do not apply to other insurance to which the additional insured has been added as an additional insured.

When this insurance is excess, we will have no duty under this Coverage Part to defend the insured against any "suit" if any other insurer has a duty to defend the insured against that "suit". If no other insurer defends, we will undertake to do so, but we will be entitled to the insured's rights against all those other insurers.

When this insurance is excess over other insurance, we will pay only our share of the amount of the loss, if any, that exceeds the sum of:

- (1)** The total amount that all such other insurance would pay for the loss in the absence of this insurance; and
- (2)** The total of all deductible and self-insured amounts under all that other insurance.

We will share the remaining loss, if any, with any other insurance that is not described in this Excess Insurance provision and was not bought specifically to apply in excess of the Limits of Insurance shown in the Declarations of this Coverage Part.

c. Method Of Sharing

If all the other insurance permits contribution by equal shares, we will follow this method also. Under this approach, each insurer contributes equal amounts until it has paid its applicable limit of insurance or none of the loss remains, whichever comes first.

If any of the other insurance does not permit contribution by equal shares, we will contribute by limits. Under this method, each insurer's share is based on the ratio of its applicable limit of insurance to the total applicable limits of insurance of all insurers.

8. Transfer Of Rights Of Recovery Against Others To Us

a. Transfer Of Rights Of Recovery

If the insured has rights to recover all or part of any payment, including Supplementary Payments, we have made under this Coverage Part, those rights are transferred to us. The insured must do nothing after loss to impair them. At our request, the insured will bring "suit" or transfer those rights to us and help us enforce them. This condition does not apply to Medical Expenses Coverage.

b. Waiver Of Rights Of Recovery (Waiver Of Subrogation)

If the insured has waived any rights of recovery against any person or organization for all or part of any payment, including Supplementary Payments, we have made under this Coverage Part, we also waive that right, provided the insured waived their rights of recovery against such person or organization in a contract, agreement or permit that was executed prior to the injury or damage.

F. OPTIONAL ADDITIONAL INSURED COVERAGES

If listed or shown as applicable in the Declarations, one or more of the following Optional Additional Insured Coverages also apply. When any of these Optional Additional Insured Coverages apply, Paragraph 6. (Additional Insureds When Required by Written Contract, Written Agreement or Permit) of Section C., Who Is An Insured, does not apply to the person or organization shown in the Declarations. These coverages are subject to the terms and conditions applicable to Business Liability Coverage in this policy, except as provided below:

1. Additional Insured - Designated Person Or Organization

WHO IS AN INSURED under Section C. is amended to include as an additional insured the person(s) or organization(s) shown in the Declarations, but only with respect to liability for "bodily injury", "property damage" or "personal and advertising injury" caused, in whole or in part, by your acts or omissions or the acts or omissions of those acting on your behalf:

- a. In the performance of your ongoing operations; or
- b. In connection with your premises owned by or rented to you.

2. Additional Insured - Managers Or Lessors Of Premises

a. WHO IS AN INSURED under Section C. is amended to include as an additional insured the person(s) or organization(s) shown in the Declarations as an Additional Insured - Designated Person Or Organization; but only with respect to liability arising out of the ownership, maintenance or use of that part of the premises leased to you and shown in the Declarations.

b. With respect to the insurance afforded to these additional insureds, the following additional exclusions apply:

This insurance does not apply to:

- (1) Any "occurrence" which takes place after you cease to be a tenant in that premises; or
- (2) Structural alterations, new construction or demolition operations performed by or on behalf of such person or organization.

3. Additional Insured - Grantor Of Franchise

WHO IS AN INSURED under Section C. is amended to include as an additional insured the person(s) or organization(s) shown in the Declarations as an Additional Insured - Grantor Of Franchise, but only with respect to their liability as grantor of franchise to you.

4. Additional Insured - Lessor Of Leased Equipment

a. WHO IS AN INSURED under Section C. is amended to include as an additional insured the person(s) or organization(s) shown in the Declarations as an Additional Insured – Lessor of Leased Equipment, but only with respect to liability for "bodily injury", "property damage" or "personal and advertising injury" caused, in whole or in part, by your maintenance, operation or use of equipment leased to you by such person(s) or organization(s).

b. With respect to the insurance afforded to these additional insureds, this insurance does not apply to any "occurrence" which takes place after you cease to lease that equipment.

5. Additional Insured - Owners Or Other Interests From Whom Land Has Been Leased

a. WHO IS AN INSURED under Section C. is amended to include as an additional insured the person(s) or organization(s) shown in the Declarations as an Additional Insured – Owners Or Other Interests From Whom Land Has Been Leased, but only with respect to liability arising out of the ownership, maintenance or use of that part of the land leased to you and shown in the Declarations.

b. With respect to the insurance afforded to these additional insureds, the following additional exclusions apply:

This insurance does not apply to:

- (1) Any "occurrence" that takes place after you cease to lease that land; or
- (2) Structural alterations, new construction or demolition operations performed by or on behalf of such person or organization.

6. Additional Insured - State Or Political Subdivision – Permits

a. WHO IS AN INSURED under Section C. is amended to include as an additional insured the state or political subdivision shown in the Declarations as an Additional

Insured – State Or Political Subdivision - Permits, but only with respect to operations performed by you or on your behalf for which the state or political subdivision has issued a permit.

- b.** With respect to the insurance afforded to these additional insureds, the following additional exclusions apply:

This insurance does not apply to:

- (1)** "Bodily injury", "property damage" or "personal and advertising injury" arising out of operations performed for the state or municipality; or
- (2)** "Bodily injury" or "property damage" included in the "product-completed operations" hazard.

7. Additional Insured – Vendors

- a.** WHO IS AN INSURED under Section **C.** is amended to include as an additional insured the person(s) or organization(s) (referred to below as vendor) shown in the Declarations as an Additional Insured - Vendor, but only with respect to "bodily injury" or "property damage" arising out of "your products" which are distributed or sold in the regular course of the vendor's business and only if this Coverage Part provides coverage for "bodily injury" or "property damage" included within the "products-completed operations hazard".
- b.** The insurance afforded to the vendor is subject to the following additional exclusions:

- (1)** This insurance does not apply to:
 - (a)** "Bodily injury" or "property damage" for which the vendor is obligated to pay damages by reason of the assumption of liability in a contract or agreement. This exclusion does not apply to liability for damages that the vendor would have in the absence of the contract or agreement;
 - (b)** Any express warranty unauthorized by you;
 - (c)** Any physical or chemical change in the product made intentionally by the vendor;
 - (d)** Repackaging, unless unpacked solely for the purpose of inspection, demonstration, testing, or the substitution of parts under instructions from the manufacturer, and then repackaged in the original container;

- (e)** Any failure to make such inspections, adjustments, tests or servicing as the vendor has agreed to make or normally undertakes to make in the usual course of business, in connection with the distribution or sale of the products;
- (f)** Demonstration, installation, servicing or repair operations, except such operations performed at the vendor's premises in connection with the sale of the product;
- (g)** Products which, after distribution or sale by you, have been labeled or relabeled or used as a container, part or ingredient of any other thing or substance by or for the vendor; or
- (h)** "Bodily injury" or "property damage" arising out of the sole negligence of the vendor for its own acts or omissions or those of its employees or anyone else acting on its behalf. However, this exclusion does not apply to:

- (i)** The exceptions contained in Subparagraphs **(d)** or **(f)**; or
- (ii)** Such inspections, adjustments, tests or servicing as the vendor has agreed to make or normally undertakes to make in the usual course of business, in connection with the distribution or sale of the products.

- (2)** This insurance does not apply to any insured person or organization from whom you have acquired such products, or any ingredient, part or container, entering into, accompanying or containing such products.

8. Additional Insured – Controlling Interest

WHO IS AN INSURED under Section **C.** is amended to include as an additional insured the person(s) or organization(s) shown in the Declarations as an Additional Insured – Controlling Interest, but only with respect to their liability arising out of:

- a.** Their financial control of you; or
- b.** Premises they own, maintain or control while you lease or occupy these premises.

BUSINESS LIABILITY COVERAGE FORM

This insurance does not apply to structural alterations, new construction and demolition operations performed by or for that person or organization.

9. Additional Insured – Owners, Lessees Or Contractors – Scheduled Person Or Organization

a. WHO IS AN INSURED under Section C. is amended to include as an additional insured the person(s) or organization(s) shown in the Declarations as an Additional Insured – Owner, Lessees Or Contractors, but only with respect to liability for "bodily injury", "property damage" or "personal and advertising injury" caused, in whole or in part, by your acts or omissions or the acts or omissions of those acting on your behalf:

- (1) In the performance of your ongoing operations for the additional insured(s); or
- (2) In connection with "your work" performed for that additional insured and included within the "products-completed operations hazard", but only if this Coverage Part provides coverage for "bodily injury" or "property damage" included within the "products-completed operations hazard".

b. With respect to the insurance afforded to these additional insureds, this insurance does not apply to "bodily injury", "property damage" or "personal an advertising injury" arising out of the rendering of, or the failure to render, any professional architectural, engineering or surveying services, including:

- (1) The preparing, approving, or failure to prepare or approve, maps, shop drawings, opinions, reports, surveys, field orders, change orders, designs or drawings and specifications; or
- (2) Supervisory, inspection, architectural or engineering activities.

10. Additional Insured – Co-Owner Of Insured Premises

WHO IS AN INSURED under Section C. is amended to include as an additional insured the person(s) or Organization(s) shown in the Declarations as an Additional Insured – Co-Owner Of Insured Premises, but only with respect to their liability as co-owner of the premises shown in the Declarations.

The limits of insurance that apply to additional insureds are described in Section D. – Limits Of Insurance.

How this insurance applies when other insurance is available to an additional insured is described in the Other Insurance Condition in Section E. – Liability And Medical Expenses General Conditions.

G. LIABILITY AND MEDICAL EXPENSES DEFINITIONS

1. "Advertisement" means the widespread public dissemination of information or images that has the purpose of inducing the sale of goods, products or services through:

- a. (1) Radio;
- (2) Television;
- (3) Billboard;
- (4) Magazine;
- (5) Newspaper;

b. The Internet, but only that part of a web site that is about goods, products or services for the purposes of inducing the sale of goods, products or services; or

c. Any other publication that is given widespread public distribution.

However, "advertisement" does not include:

a. The design, printed material, information or images contained in, on or upon the packaging or labeling of any goods or products; or

b. An interactive conversation between or among persons through a computer network.

2. "Advertising idea" means any idea for an "advertisement".

3. "Asbestos hazard" means an exposure or threat of exposure to the actual or alleged properties of asbestos and includes the mere presence of asbestos in any form.

4. "Auto" means a land motor vehicle, trailer or semi-trailer designed for travel on public roads, including any attached machinery or equipment. But "auto" does not include "mobile equipment".

5. "Bodily injury" means physical:

- a. Injury;
- b. Sickness; or
- c. Disease

sustained by a person and, if arising out of the above, mental anguish or death at any time.

6. "Coverage territory" means:

- a. The United States of America (including its territories and possessions), Puerto Rico and Canada;
- b. International waters or airspace, but only if the injury or damage occurs in the course of travel or transportation between any places included in **a.** above;
- c. All other parts of the world if the injury or damage arises out of:
 - (1) Goods or products made or sold by you in the territory described in **a.** above;
 - (2) The activities of a person whose home is in the territory described in **a.** above, but is away for a short time on your business; or
 - (3) "Personal and advertising injury" offenses that take place through the Internet or similar electronic means of communication

provided the insured's responsibility to pay damages is determined in the United States of America (including its territories and possessions), Puerto Rico or Canada, in a "suit" on the merits according to the substantive law in such territory, or in a settlement we agree to.

- 7. "Electronic data" means information, facts or programs:
 - a. Stored as or on;
 - b. Created or used on; or
 - c. Transmitted to or from computer software, including systems and applications software, hard or floppy disks, CD-ROMS, tapes, drives, cells, data processing devices or any other media which are used with electronically controlled equipment.
- 8. "Employee" includes a "leased worker". "Employee" does not include a "temporary worker".
- 9. "Executive officer" means a person holding any of the officer positions created by your charter, constitution, by-laws or any other similar governing document.
- 10. "Hostile fire" means one which becomes uncontrollable or breaks out from where it was intended to be.
- 11. "Impaired property" means tangible property, other than "your product" or "your work", that cannot be used or is less useful because:
 - a. It incorporates "your product" or "your work" that is known or thought to be defective, deficient, inadequate or dangerous; or

- b. You have failed to fulfill the terms of a contract or agreement;
- if such property can be restored to use by:

- a. The repair, replacement, adjustment or removal of "your product" or "your work"; or
- b. Your fulfilling the terms of the contract or agreement.

12. "Insured contract" means:

- a. A contract for a lease of premises. However, that portion of the contract for a lease of premises that indemnifies any person or organization for damage by fire, lightning or explosion to premises while rented to you or temporarily occupied by you with permission of the owner is subject to the Damage To Premises Rented To You limit described in Section **D. – Liability and Medical Expenses Limits of Insurance.**
- b. A sidetrack agreement;
- c. Any easement or license agreement, including an easement or license agreement in connection with construction or demolition operations on or within 50 feet of a railroad;
- d. Any obligation, as required by ordinance, to indemnify a municipality, except in connection with work for a municipality;
- e. An elevator maintenance agreement; or
- f. That part of any other contract or agreement pertaining to your business (including an indemnification of a municipality in connection with work performed for a municipality) under which you assume the tort liability of another party to pay for "bodily injury" or "property damage" to a third person or organization, provided the "bodily injury" or "property damage" is caused, in whole or in part, by you or by those acting on your behalf. Tort liability means a liability that would be imposed by law in the absence of any contract or agreement.

Paragraph **f.** includes that part of any contract or agreement that indemnifies a railroad for "bodily injury" or "property damage" arising out of construction or demolition operations within 50 feet of any railroad property and affecting any railroad bridge or trestle, tracks, road-beds, tunnel, underpass or crossing.

However, Paragraph **f.** does not include that part of any contract or agreement:

BUSINESS LIABILITY COVERAGE FORM

- (1) That indemnifies an architect, engineer or surveyor for injury or damage arising out of:
 - (a) Preparing, approving or failing to prepare or approve maps, shop drawings, opinions, reports, surveys, field orders, change orders, designs or drawings and specifications; or
 - (b) Giving directions or instructions, or failing to give them, if that is the primary cause of the injury or damage; or
 - (2) Under which the insured, if an architect, engineer or surveyor, assumes liability for an injury or damage arising out of the insured's rendering or failure to render professional services, including those listed in (1) above and supervisory, inspection, architectural or engineering activities.
13. "Leased worker" means a person leased to you by a labor leasing firm under an agreement between you and the labor leasing firm, to perform duties related to the conduct of your business. "Leased worker" does not include a "temporary worker".
14. "Loading or unloading" means the handling of property:
 - a. After it is moved from the place where it is accepted for movement into or onto an aircraft, watercraft or "auto";
 - b. While it is in or on an aircraft, watercraft or "auto"; or
 - c. While it is being moved from an aircraft, watercraft or "auto" to the place where it is finally delivered;but "loading or unloading" does not include the movement of property by means of a mechanical device, other than a hand truck, that is not attached to the aircraft, watercraft or "auto".
15. "Mobile equipment" means any of the following types of land vehicles, including any attached machinery or equipment:
 - a. Bulldozers, farm machinery, forklifts and other vehicles designed for use principally off public roads;
 - b. Vehicles maintained for use solely on or next to premises you own or rent;
 - c. Vehicles that travel on crawler treads;
 - d. Vehicles, whether self-propelled or not, on which are permanently mounted:
 - (1) Power cranes, shovels, loaders, diggers or drills; or
 - (2) Road construction or resurfacing equipment such as graders, scrapers or rollers;
- e. Vehicles not described in a., b., c., or d. above that are not self-propelled and are maintained primarily to provide mobility to permanently attached equipment of the following types:
 - (1) Air compressors, pumps and generators, including spraying, welding, building cleaning, geophysical exploration, lighting and well servicing equipment; or
 - (2) Cherry pickers and similar devices used to raise or lower workers;
- f. Vehicles not described in a., b., c., or d. above maintained primarily for purposes other than the transportation of persons or cargo.

However, self-propelled vehicles with the following types of permanently attached equipment are not "mobile equipment" but will be considered "autos":

 - (1) Equipment, of at least 1,000 pounds gross vehicle weight, designed primarily for:
 - (a) Snow removal;
 - (b) Road maintenance, but not construction or resurfacing; or
 - (c) Street cleaning;
 - (2) Cherry pickers and similar devices mounted on automobile or truck chassis and used to raise or lower workers; and
 - (3) Air compressors, pumps and generators, including spraying, welding, building cleaning, geophysical exploration, lighting and well servicing equipment.
16. "Occurrence" means an accident, including continuous or repeated exposure to substantially the same general harmful conditions.
17. "Personal and advertising injury" means injury, including consequential "bodily injury", arising out of one or more of the following offenses:
 - a. False arrest, detention or imprisonment;
 - b. Malicious prosecution;

- c. The wrongful eviction from, wrongful entry into, or invasion of the right of private occupancy of a room, dwelling or premises that the person occupies, committed by or on behalf of its owner, landlord or lessor;
 - d. Oral, written or electronic publication of material that slanders or libels a person or organization or disparages a person's or organization's goods, products or services;
 - e. Oral, written or electronic publication of material that violates a person's right of privacy;
 - f. Copying, in your "advertisement", a person's or organization's "advertising idea" or style of "advertisement";
 - g. Infringement of copyright, slogan, or title of any literary or artistic work, in your "advertisement"; or
 - h. Discrimination or humiliation that results in injury to the feelings or reputation of a natural person.
- 18.** "Pollutants" means any solid, liquid, gaseous or thermal irritant or contaminant, including smoke, vapor, soot, fumes, acids, alkalis, chemicals and waste. Waste includes materials to be recycled, reconditioned or reclaimed.
- 19.** "Products-completed operations hazard";
- a. Includes all "bodily injury" and "property damage" occurring away from premises you own or rent and arising out of "your product" or "your work" except:
 - (1) Products that are still in your physical possession; or
 - (2) Work that has not yet been completed or abandoned. However, "your work" will be deemed to be completed at the earliest of the following times:
 - (a) When all of the work called for in your contract has been completed.
 - (b) When all of the work to be done at the job site has been completed if your contract calls for work at more than one job site.
 - (c) When that part of the work done at a job site has been put to its intended use by any person or organization other than another contractor or subcontractor working on the same project.
- Work that may need service, maintenance, correction, repair or replacement, but which is otherwise complete, will be treated as completed.
- The "bodily injury" or "property damage" must occur away from premises you own or rent, unless your business includes the selling, handling or distribution of "your product" for consumption on premises you own or rent.
- b. Does not include "bodily injury" or "property damage" arising out of:
 - (1) The transportation of property, unless the injury or damage arises out of a condition in or on a vehicle not owned or operated by you, and that condition was created by the "loading or unloading" of that vehicle by any insured; or
 - (2) The existence of tools, uninstalled equipment or abandoned or unused materials.
- 20.** "Property damage" means:
- a. Physical injury to tangible property, including all resulting loss of use of that property. All such loss of use shall be deemed to occur at the time of the physical injury that caused it; or
 - b. Loss of use of tangible property that is not physically injured. All such loss of use shall be deemed to occur at the time of "occurrence" that caused it.
- As used in this definition, "electronic data" is not tangible property.
- 21.** "Suit" means a civil proceeding in which damages because of "bodily injury", "property damage" or "personal and advertising injury" to which this insurance applies are alleged. "Suit" includes:
- a. An arbitration proceeding in which such damages are claimed and to which the insured must submit or does submit with our consent; or
 - b. Any other alternative dispute resolution proceeding in which such damages are claimed and to which the insured submits with our consent.
- 22.** "Temporary worker" means a person who is furnished to you to substitute for a permanent "employee" on leave or to meet seasonal or short-term workload conditions.
- 23.** "Volunteer worker" means a person who:
- a. Is not your "employee";

BUSINESS LIABILITY COVERAGE FORM

- b. Donates his or her work;
 - c. Acts at the direction of and within the scope of duties determined by you; and
 - d. Is not paid a fee, salary or other compensation by you or anyone else for their work performed for you.
- 24. "Your product":**
- a. Means:
 - (1) Any goods or products, other than real property, manufactured, sold, handled, distributed or disposed of by:
 - (a) You;
 - (b) Others trading under your name; or
 - (c) A person or organization whose business or assets you have acquired; and
 - (2) Containers (other than vehicles), materials, parts or equipment furnished in connection with such goods or products.
 - b. Includes:
 - (1) Warranties or representations made at any time with respect to the fitness, quality, durability, performance or use of "your product"; and
 - (2) The providing of or failure to provide warnings or instructions.
- 25. "Your work":**
- a. Means:
 - (1) Work or operations performed by you or on your behalf; and
 - (2) Materials, parts or equipment furnished in connection with such work or operations.
 - b. Includes:
 - (1) Warranties or representations made at any time with respect to the fitness, quality, durability, performance or use of "your work"; and
 - (2) The providing of or failure to provide warnings or instructions.



THIS ENDORSEMENT CHANGES THE POLICY. PLEASE READ IT CAREFULLY.

NOTICE OF CANCELLATION TO CERTIFICATE HOLDER(S)

Policy Number: 37 WEC CC3741

Effective Date: 01/05/18

Named Insured and Address: ENCOMPAS CORPORATION

1512 GRAND BLVD

KANSAS CITY MO 64108

Endorsement Number:

Effective hour is the same as stated on the Information Page of the policy.

This policy is subject to the following additional Conditions:

- A. If this policy is cancelled by the Company, other than for non-payment of premium, notice of such cancellation will be provided at least thirty (30) days in advance of the cancellation effective date to the certificate holder(s) with mailing addresses on file with the agent of record or the Company.
- B. If this policy is cancelled by the Company for non-payment of premium, or by the insured, notice of such cancellation will be provided within ten (10) days of the cancellation effective date to the certificate holder(s) with mailing addresses on file with the agent of record or the Company.

If notice is mailed, proof of mailing to the last known mailing address of the certificate holder(s) on file with the agent of record or the Company will be sufficient proof of notice.

Any notification rights provided by this endorsement apply only to active certificate holder(s) who were issued a certificate of insurance applicable to this policy's term.

Failure to provide such notice to the certificate holder(s) will not amend or extend the date the cancellation becomes effective, nor will it negate cancellation of the policy. Failure to send notice shall impose no liability of any kind upon the Company or its agents or representatives.



THIS ENDORSEMENT CHANGES THE POLICY. PLEASE READ IT CAREFULLY.

**WAIVER OF OUR RIGHT TO RECOVER
FROM OTHERS ENDORSEMENT**

Policy Number: 37 WEC CC3741

Endorsement Number:

Effective Date: 01/05/18

Effective hour is the same as stated on the Information Page of the policy.

Named Insured and Address: ENCOMPAS CORPORATION

1512 GRAND BLVD

KANSAS CITY MO 64108

We have the right to recover our payments from anyone liable for an injury covered by this policy. We will not enforce our right against the person or organization named in the Schedule.

This agreement shall not operate directly or indirectly to benefit anyone not named in the Schedule.

SCHEDULE

Any person or organization from whom you are required by contract or agreement to obtain this waiver from us. Endorsement is not applicable in KY, NH, NJ or for any MO construction risk

Countersigned by _____
Authorized Representative

ATTACHMENT A.1

Discount Schedule

LINCOLN LANCASTER CITY PUBLIC BUILDING

N041296/11640 AA for orders shipping to continental U.S. locations, accessing U.S. price list

Product Group	Systems and Tables Products	Seating Products	Freestanding Products	Wood Casegoods & Wood Tables	Architectural Interiors	List Dollar Value	Customer Discount Product Only
I Regular Lead Time	UniGroup® NW/WT PLACES® NW/WT UniGroup Too, Adaptable Components, Compose					\$1-\$884,016 \$884,017-\$2,062,706 \$2,062,707 or More	70.9% 74.78% Negotiable
RUSH**						\$1 or More	63.6%
II Regular Lead Time		Accolade®, Monaco®				\$1-\$25,000 \$25,001-\$300,000 \$300,001 or More	58% 60% Negotiable
RUSH**						\$1 or More	52%
III Regular Lead Time	PLACES® FW Patterns, Reside			PLACES® Wood Casegoods, Series K™, Orlando™, Tripoli™, Vancouver™, York, Masters		\$1 or More	54.55%
RUSH**						\$1 or More	44.45%
IV Regular Lead Time	if®		950 Series Files			\$1-\$1,456,027 \$1,456,028 or More	64.68% Negotiable
RUSH**						\$1 or More	58.4%
V Regular Lead Time		Improv®, System12 Look™				\$1 or More	61.72%
RUSH**						\$1 or More	58.18%
VI Regular Lead Time		X99®				\$1 or More	61.7%
RUSH**						\$1 or More	44.45%
VII Regular Lead Time	Tactics®, 450 Series, Tempo, Planes Compose Storage	Tempo				\$1 or More	60.5%
RUSH**						\$1 or More	56.93%
VIII Regular Lead Time		Composites™, Forenze™, Galerie™, Hello™, Prescott™, Tally™, Tuxedo™, ToDo®				\$1 or More	55.16%
RUSH**						\$1 or More	44.59%
IX Regular Lead Time	PREMISE® NW/WT Moxie™, Components					\$1-\$727,214 \$727,215-\$1,772,421 \$1,772,422 or More	68.15% 70.65% Negotiable
RUSH**						\$1 or More	56%

Product Group	Systems and Tables Products	Seating Products	Freestanding Products	Wood Casegoods & Wood Tables	Architectural Interiors	List Dollar Value	Customer Discount Product Only
X Regular Lead Time	RACE®		Beside X Series® Casegoods, Files & Storage V Series® Casegoods, Files & Storage			\$1-\$1,408,848 \$1,408,849 or More	63.5% Negotiable
RUSH**						\$1 or More	55.25%
XI Regular Lead Time	The Haworth Collection BRAZO, Lim, Belong, Jump®Stuff, Boogie® Board Workware					\$1 or More	40%
RUSH**						\$1 or More	35%
XII Regular Lead Time	Castelli					\$1 or More	35%
RUSH**						\$1 or More	35%
XIII Regular Lead Time		Very™, Very Task™ Zody,				\$1 or More	57%
XIV Regular Lead Time		Fern				\$1 or More	50%
XVI Regular Lead Time	Everyday Office(Jump, Jive, Hop and Swivel)					\$1 or More	50%
XVII Regular Lead Time		Cassis, Candor, Lively				\$1 or More	59%
XVII Regular Lead Time		Soji				\$1 or more	60%

Price List: Current price list.

**Seller offers the above mentioned discounts on products included in this Agreement which are offered in Seller's RUSH Programs. See the current price list(s) for a description of the products included in this program.

- A. Only the items stated within each product group may be combined on a single purchase order for purposes of attaining a higher discount tier and/or negotiable discount tier. DIFFERENT PRODUCT GROUPS OR LEAD TIMES MAY NOT be combined together for purposes of attaining the next pricing tier.
- B. The applicable discount will be separately negotiated for new products or lead time programs introduced by Seller during the term of this Agreement.

General Description of Seating Proposed in this RFP:

Haworth

Prices for each chair proposed include the following (exceptions noted below):

4D Arms
Adjustable Lumbar
Adjustable Seat Pan (seat depth)
Back Lock
Plastic Base (metal bases are available)
Mesh Back & Upholstered Seat

Exceptions: Improv has height adjustable arms but instead of 4D, they are 'flipper'allowing them to rotate out of the way.

Improv chair backs are fully upholstered and include an internal bladder which can be pumped up to increase lumbar support.

Improv chairs continue to be extremely popular with the city and county agencies as they are ordered regularly.

Note:

The Haworth Soji chair is brand new. It's not even included in the seating catalogue yet, therefore we've attached its preliminary price pages which will be added to the seating catalogue in the next few weeks.

Via - 4U

Arms adjust for height and width.

Seating

North America Price List – April 2018



This Haworth North American price book contains US list prices.



Canadian customers can convert the US list price into their Canadian equivalent by going to www.Haworth.com/Canada to find the current Canadian multipliers. These multiplier factors allow you to convert the US list price into a Canadian list price.

The following list gives a general overview of the content included within this price list and explains how the book is organized and where certain information can be found.

- 1 Front Cover**
 - Includes the title and pricing effectivity date.
- 2 Electronic Update Page / Canadian Conversion**
 - Electronic versions of the Price Book (.pdf files) will include an Electronic Update Page listing the most recent updates and addendum added since the original version was created. If this section is blank no updates or addendums have been added.
 - Each update will include a description, page number, date and a link to the updated or new page.
 - The footer contains Canadian conversion information for converting US pricing into it's Canadian equivalent.
- 3 Table of Contents**
 - Price List content with page numbers.
- 4 Statement of Line**
 - Provides a pictorial outline of the product offering.
- 5 Price List**
 - Each price list page contains the following:
 - Product Illustration
 - Catalog Number
 - To Order Specify – sequencing for ordering product options and finishes
 - List Prices
 - Product Specification Dimensions
 - Features
 - Specification Tips
 - Class, Discount Group Number (used for discounting) and GSA information
- 6 Finishes, Fabrics and COM**
 - Lists information for material finishes and availability.
 - Provides COM information and requirements (if applicable).
- 7 North American Terms of Sale**
 - Haworth terms for ordering, pricing, shipping and delivery, general terms, and services.
- 8 Index**
 - Products are listed alphabetically by alpha-numeric catalog numbers with price list page number.
- 9 Product Non-Obsolescence and Warranty Policy**
 - Provides Haworth policy for non-obsolescence and warranty.

Additional Information and Resources

Prices are subject to change without notice or approval. Haworth dealers should always submit proposals through Lynx before presenting to customers. See North American Terms of Sale for more information.

Online Resources

haworth.com

- Haworth's corporate website provides access to price books and a variety of other resources and publications.

surfaces.haworth.com

- Website provides access to the most current fabrics and finishes offered across Haworth's various product lines.

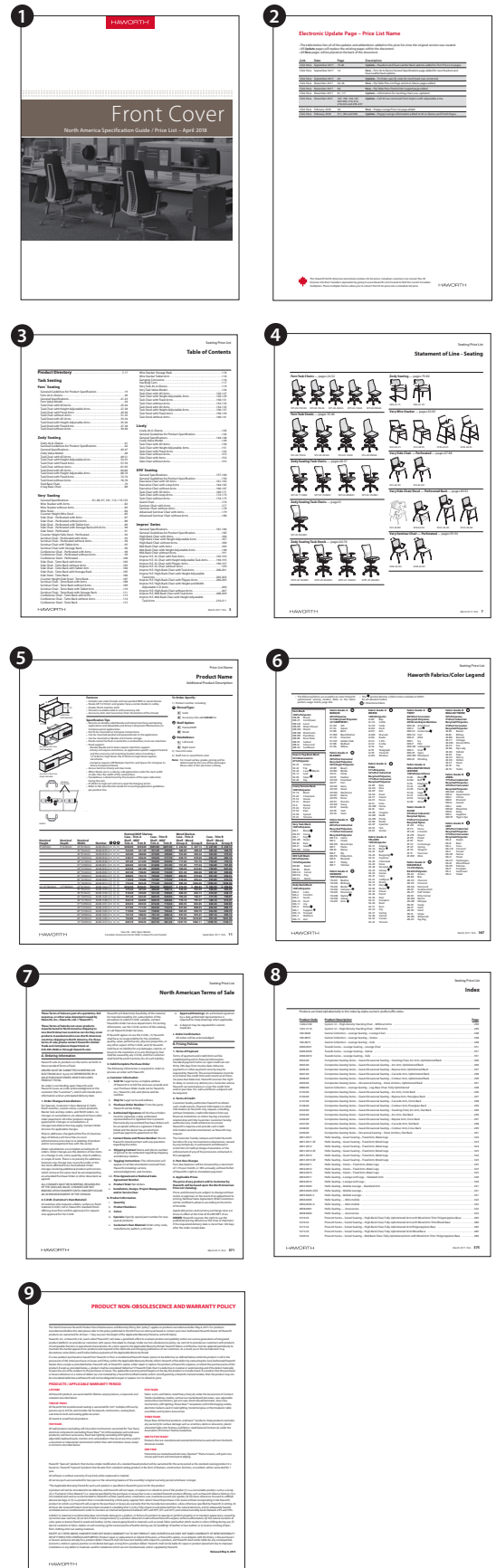

Table of Contents

Product Directory7-15

Task Seating

Fern™ Seating

General Guidelines for Product Specification.....	17
Fern-At-A-Glance.....	18
General Specifications.....	19-21
Fern Value Model.....	22
Task Chair with 4D Arms.....	23-24
Task Chair with Height Adjustable Arms.....	25-26
Task Chair with Fixed Arms.....	27-28
Task Chair without Arms.....	29-30
Task Stool with 4D Arms.....	31-32
Task Stool with Height Adjustable Arms.....	33-34
Task Stool with Fixed Arms.....	35-36
Task Stool without Arms.....	37-38

Zody® Seating

Zody-At-A-Glance.....	39
General Guidelines for Product Specification.....	40-41
General Specifications.....	42-45
Zody Value Model.....	46
Task Chair with 4D Arms.....	47-49
Task Chair with Height Adjustable Arms.....	51-53
Task Chair with Fixed Arms.....	55-57
Task Chair without Arms.....	59-61
Task Stool with 4D Arms.....	62-64
Task Stool with Height Adjustable Arms.....	66-68
Task Stool with Fixed Arms.....	70-72
Task Stool without Arms.....	74-76
Sled Base Chair.....	77
4 Leg Base Chair.....	78

Very® Seating

General Specifications.....	79, 84, 95, 99, 110, 117-121
Wire Stacker with Arms.....	80
Wire Stacker without Arms.....	81
Wire Stool.....	82
Counter Height Wire Stool.....	83
Side Chair - Perforated with Arms.....	85
Side Chair - Perforated without Arms.....	86
Side Chair - Perforated with Tablet Arm.....	87
Side Chair - Perforated with Storage Rack with Arms.....	88
Side Stool - Perforated.....	89
Counter Height Side Stool - Perforated.....	90
Seminar Chair - Perforated with Arms.....	91
Seminar Chair - Perforated without Arms.....	92
Seminar Chair with Tablet Arm.....	93
Seminar Chair with Storage Rack.....	94
Conference Chair - Perforated with Arms.....	96
Conference Chair - Perforated without Arms.....	97
Conference Stool - Perforated.....	98
Side Chair - Tetro Back with Arms.....	100
Side Chair - Tetro Back without Arms.....	101
Side Chair - Tetro Back with Tablet Arm.....	102
Side Chair - Tetro Back with Storage Rack.....	103
Side Stool - Tetro Back.....	104
Counter Height Side Stool - Tetro Back.....	105
Seminar Chair - Tetro Back with Arms.....	106
Seminar Chair - Tetro Back without Arms.....	107
Seminar Chair - Tetro Back with Tablet Arm.....	108
Seminar Chair - Tetro Back with Storage Rack.....	109
Conference Chair - Tetro Back with Arms.....	111
Conference Chair - Tetro Back without Arms.....	112
Conference Stool - Tetro Back.....	113

Wire Stacker Storage Rack.....	114
Wire Stacker Tablet Arm.....	114
Ganging Connector.....	114
Stacking Carts.....	115
Very Task-At-A-Glance.....	117
Very Task Value Model.....	122
Task Chair with 4D Arms.....	124-125
Task Chair with Height Adjustable Arms.....	126-127
Task Chair with Fixed Arms.....	128-129
Task Chair without Arms.....	130-131
Task Stool with 4D Arms.....	132-133
Task Stool with Height Adjustable Arms.....	134-135
Task Stool with Fixed Arms.....	136-137
Task Stool without Arms.....	138-139

Lively®

Lively-At-A-Glance.....	141
General Guidelines for Product Specification.....	142
General Specifications.....	142-146
Lively Value Model.....	147
Task Chair with 4D Arms.....	148
Task Chair with Height Adjustable Arms.....	149
Task Chair with Fixed Arms.....	150
Task Chair without Arms.....	151
Side Chair with Arms.....	152
Side Chair without Arms.....	153

X99® Seating

General Specifications.....	155-158
General Guidelines for Product Specification.....	157
Executive Chair with 3D Arms.....	159-161
Executive Chair with Loop Arms.....	162-163
Executive Chair without Arms.....	164-165
Task Chair with 3D Arms.....	167-169
Task Chair with Loop Arms.....	170-171
Task Chair without Arms.....	172-173
Guest Chair.....	174
Seminar Chair with Arms.....	175
Seminar Chair without Arms.....	176
Advanced Seminar Chair with Arms.....	177
Advanced Seminar Chair without Arms.....	178

Improv® Series

General Specifications.....	179-182
General Guidelines for Product Specification.....	183
High-Back Chair with Arms.....	184
High-Back Chair with Height Adjustable Arms.....	185
High-Back Chair without Arms.....	186
Mid-Back Chair with Arms.....	187
Mid-Back Chair with Height Adjustable Arms.....	188
Mid-Back Chair without Arms.....	189
Improv H.E. XL Chair with Task Arms.....	190-191
Improv H.E. XL Chair with Height Adjustable Task Arms.....	192-193
Improv H.E. XL Chair with Flipper Arms.....	194-195
Improv H.E. XL Chair without Arms.....	197
Improv H.E. High-Back Chair with Task Arms.....	198-199
Improv H.E. High-Back Chair with Height Adjustable Task Arms.....	200-201
Improv H.E. High-Back Chair with Flipper Arms.....	202-203
Improv H.E. High-Back Chair with Height and Width Adjustable 3-D Arms.....	204
Improv H.E. High-Back Chair without Arms.....	205
Improv H.E. Mid-Back Chair with Task Arms.....	206-207
Improv H.E. Mid-Back Chair with Height Adjustable Task Arms.....	208-209

Table of Contents

Improv H.E. Mid-Back Chair with Flipper Arms	210-211
Improv H.E. Mid-Back Chair with Height and Width Adjustable 3-D Arms	212
Improv H.E. Mid-Back Chair without Arms	213
Improv H.E. Stool with Task Arms	214-215
Improv H.E. Stool with Height Adjustable Task Arms	216-217
Improv H.E. Stool with Flipper Arms	218-219
Improv H.E. Stool with Height and Width Adjustable 3-D Arms	220
Improv H.E. Stool without Arms	221
Improv S.E. Mesh-Back Chair without Arms	222
Improv S.E. Mesh-Back Chair with Task Arms	224-225
Improv S.E. Mesh-Back Chair with Height Adjustable Task Arms	226-227
Improv S.E. Mesh-Back Chair with Flipper Arms	228-229
Improv S.E. Mesh-Back Chair with Height and Width Adjustable 3-D Arms	230
Improv Tag General Specifications	231
Improv Tag, Mesh Back Chair without Arms	232
Improv Tag, Mesh Back Chair with Fixed-Height Task Arms	233
Improv Tag, Mesh Back Chair with Height-Adjustable Task Arms	234
Improv Tag, Mesh Back Chair with Height- and Width-Adjustable 3-D Arms	235
Leg-Base Stacking Chair with Arms	236
Leg-Base Stacking Chair without Arms	237
Leg-Base Stacking Chair with Tablet Arm	238
Sled-Base Chair with Arms	239
Sled-Base Chair without Arms	240
Sled-Base Chair with Tablet Arm	241
Stool with Arms	242
Stool without Arms	242
Stacking Dolly	243
Book Rack	243
Tandem Seating and Tables Specifications	244
Tandem Seating and Tables Dimensions	245
Tandem Tables and Connecting Bars	246
Occasional Tables	247

LOOK®

General Specifications	249-250
High-Back Chair without Arms	251
High-Back Chair with Fixed Arms	252
High-Back Chair with Height Adjustable Arms	253
High-Back Chair with Height and Width Adjustable Arms	254
Mid-Back Chair without Arms	255
Mid-Back Chair with Fixed Arms	256
Mid-Back Chair with Height Adjustable Arms	257
Mid-Back Chair with Height and Width Adjustable Arms	258
Side Chair without Arms	259
Side Chair with Arms	260
Lounge Chair	261

Executive Seating

Monaco®

General Specifications	263-264
General Guidelines for Product Specification	264
Large High-Back Chair with Open Arms	265
Large High-Back Chair with Enclosed Arms	266
Medium High-Back Chair with Open Arms	267
Medium High-Back Chair with Enclosed Arms	268
Large Mid-Back Chair with Open Arms	269
Large Mid-Back Chair with Enclosed Arms	270
Medium Mid-Back Chair with Open Arms	271
Medium Mid-Back Chair with Enclosed Arms	272

Stack Seating

Wood Side Seating and Tables

General Specifications	273
General Guidelines for Product Specification	273

Candor® Seating

Classic Fully Upholstered Seat and Back	274
Classic Fully Upholstered Seat and 3/4 Back	274
Classic Fully Upholstered Seat and Slat Back	274
Modern Fully Upholstered Seat and Back	275
Modern Fully Upholstered Seat and 1/2 Back	275
Modern Fully Upholstered Seat and Slat Back	275

Composites™ Seating Series

Arc Arm, Upholstered Back	276
Arc Arm, Circle Back	276
Arc Arm, Slat Back	276
Repose Arm, Upholstered Back	277
Repose Arm, Hourglass Back	277
Repose Arm, Cross Back	277
Cascade Arm, Upholstered Back	278
Cascade Arm, Circle Back	278
Cascade Arm, Slat Back	278
Contour Arm, Upholstered Back	279
Contour Arm, Hourglass Back	279
Contour Arm, Cross Back	279
Stacking Chair, Arc Arm, Upholstered Back	280
Stacking Chair, Arc Arm, Slat Back	280
Stool, Armless, Upholstered Back	281
Stool, Armless, Slat Back	281

Forenze™ Seating

Serpentine Arm, Upholstered Back	282
Curve Arm, Upholstered Back	283
Scroll Arm, Slat Back	284
Scroll Arm, Upholstered Back	284
Cabriole Arm, Slat Back	285
Cabriole Arm, Upholstered Back	285

Openest™ Collection

Plume 3	286
Plume 6	286
Plume 9	286
Feather – Symmetrical	287
Feather – Asymmetrical	287
Chick Pouf with Back	288
Chick Pouf without Back	288
Rectangle	289
Round	289

Poppy™

Poppy-At-A-Glance	291
Four Star Base with Glides	292
Five Star Base with Casters	292
Wood Base	293
Basket	294
Swivel	294

Table of Contents

Harbor Work Lounge*

Harbor Work Lounge-At-A-Glance295
Fully Upholstered, Cast Aluminum Base Lounge Chair296
Fully Upholstered, Cast Aluminum Base Ottoman297
Partially Upholstered, Cast Aluminum Base Lounge Chair298
Partially Upholstered, Cast Aluminum Base Ottoman299

Lounge

Hello® Seating

Lounge with Legs, Standard Arm300
Mobile Lounge, Standard Arm301
Tablet Arm302
Cup Holder302
Mini-mobile302
Guest Seating Fixed Arms, Wood Legs303
Guest Seating Fixed Arms, Metal Legs304
Stools Fixed Arms, Metal Legs305

ToDo®

General Specifications306-307
Single, Stationary308
Single, Mobile309
Double, Stationary310
Triple, Stationary311
Wood Tablet with Arm312
Cup Holder312
Grommet Cover312
Ottoman313

Public Seating, Education Seating and Stools

Seating and Tables

Scamps™ Series, Chair with Arms314
Scamps Series, Round Table314
Tilt Stool315

Finishes and Fabrics

Finish/Color Legends316-319
Fabric Pattern Usage Matrix320
Haworth Fabrics/Color Legend321-323
COM Information324

Terms of Sale

North America325-328
-------------------------	----------

Index329-334
------------------------	----------

Product WarrantyInside Back Cover
-----------------------------------	--------------------

Product Directory

Fern Task Chairs — pages 22-30



SFT-U0-7501A5 SFT-U0-7502A SFT-U0-4502A SFT-U0-1502A SFT-U0-0N02A

Zody Seating — pages 77-78



SZG-22-1S SZG-22-1H

Fern Task Stools — pages 31-38



SFS-U0-7502A SFS-U0-4502A SFS-U0-1502A SFS-U0-0N02A

Very Wire Stacker — pages 80-83

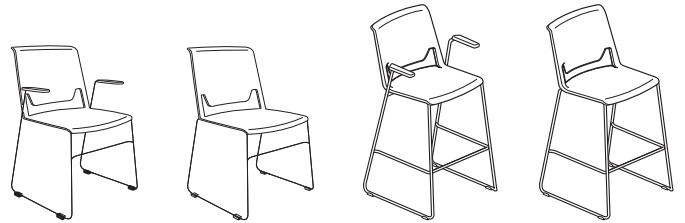

SCH-44-3S SCH-44-0S SCW-44-3S SCW-44-0S

Zody Seating Task Chairs — pages 46-55



SZT-20-711MA5 SZT-20-702MA1 SZT-20-402MA1 SZT-20-102MA1

Very Side Chair — Perforated — pages 85-86

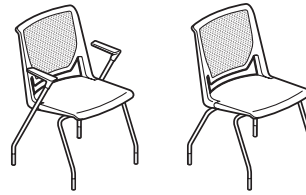

SCS-44-3H SCS-44-0H

Zody Seating Task Chairs — page 59



SZT-20-002MA1

Very Side Chair/Stool — Perforated Back — pages 87-90

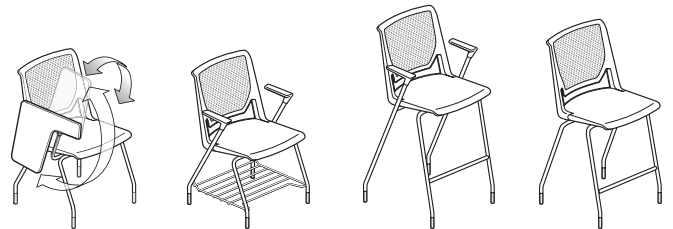

SCS-44-RH SCK-44-3H SCLC-44-3H SCLC-44-0H

Zody Seating Task Stools — pages 62-74



SZTC-20-702MA1 SZTC-20-402MA1 SZTC-20-102MA1 SZTC-20-002MA1

Very Seminar Chair — Perforated — pages 91-92

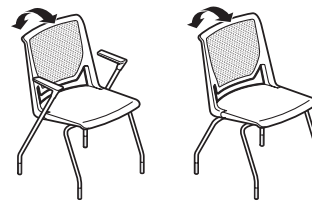

SCM-44-3H SCM-44-0H

Product Directory

Very Seminar with Tablet Arm/Storage Rack — pages 93-94



SCM-44-RH



SCB-44-3H



SCB-44-0H

Very Side Stool — Tetro Back — pages 104-105



SCL-45-3H



SCL-45-0H

Very Conference Chair — Perforated — pages 96-97



SCC-44-11



SCC-44-01

Very Seminar Chair — Tetro Back — pages 106-107



SCM-45-3H



SCM-45-0H

Very Conference Stool — Perforated — page 98



SCF-44-11



SCF-44-01

Very Seminar with Tablet Arm — Tetro Back — page 108



SCM-45-RH

Very Side Chair — Tetro Back — pages 100-101



SCS-45-3H



SCS-45-0H

Very Seminar with Storage Rack — Tetro Back — page 109



SCB-45-3H

Very Side Chair with Tablet Arm — Tetro Back — page 102



SCS-45-RH

Very Conference Chair — Tetro Back — pages 111-112



SCC-45-11



SCC-45-01

Very Side Chair with Storage Rack — Tetro Back — page 103



SCK-45-3H

Product Directory

Very Conference Stool — Tetro Back — page 113



SCF-45-11

SCF-45-01

Lively Side Chair — pages 152-153

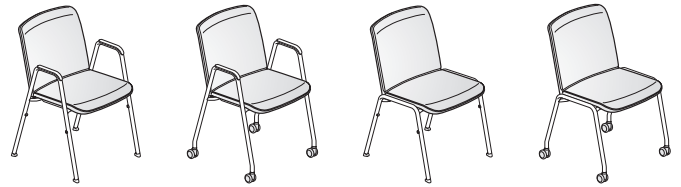

SLS1-2T-1H

SLS1-2T-11

SLS1-2T-0H

SLS1-2T-01

Very Accessories — pages 114-115

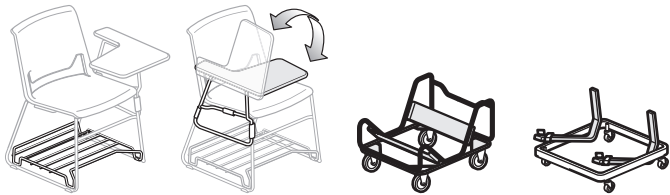

SCHR-1

SCHA-R

SCT-1

SCT-3
SCT-4

X99 Executive Seating — pages 159-165



X611-2W40
X611-2W44

X611-2140
X611-2144

X611-2040
X611-2044

Very Task Chairs — pages 122-130



SCT-20-7115

SCT-20-7011

SCT-20-4011

SCT-20-1011

SCT-20-0011

X99 Task & Guest Seating — pages 167-174

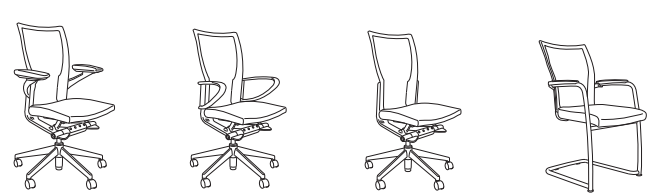

X621-2W40
X621-2W44

X621-2140
X621-2144

X621-2040
X621-2044

X630-3100

Very Task Stools — pages 132-138



SCTC-20-7011

SCTC-20-4011

SCTC-20-1011

SCTC-20-0011

X99 Seminar Chairs — pages 175-178



X640-0140

X640-0040

X641-2140

X641-2040

Lively Task Chairs — pages 147-151



SLT1-2T-7115A

SLT1-2T-7115A

SLT1-2T-4115A

SLT1-2T-1115A

SLT1-2T-0115A

Improv Series High-Back Chairs — pages 184-186



M221-1142

M221-1742

M221-1042

Product Directory

Improv Series Mid-Back Chair — pages 187-189



M211-1142 M211-1742 M211-1042

Improv Series H.E. Stools — pages 214-220



M2E1-1442 M2E1-1742 M2E1-1H42 M2E1-1W42

Improv Series H.E. XL Chairs — pages 190-197



M271-1442 M271-1742 M271-1H42 M271-1042

Improv Series H.E. Stools — page 221



M2E1-1042

Improv Series S.E. Mesh Back Chair without Arms — page 222



M235-3042

Improv Series H.E. High-Back Chairs — pages 198-204



M251-1442 M251-1742 M251-1H42 M251-1W42

Improv Series S.E. Mesh-Back Chair with Arms — pages 224-230

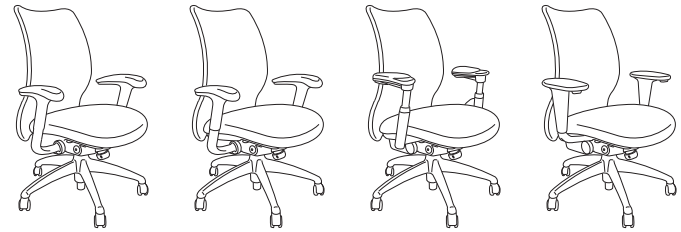

M235-3442 M235-3742 M235-3H42 M235-3W42

Improv Series H.E. High-Back Chairs — page 205



M251-1042

Improv Series H.E. Mid-Back Chairs — pages 206-209



M231-1442 M231-1742

Improv Tag Mesh Back Chairs — pages 232-235

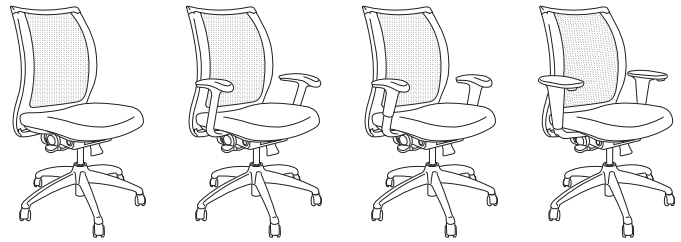

F235-2042 F235-2442 F235-2742 F235-2W42

Improv Series H.E. Mid-Back Chairs — pages 210-213



M231-1H42 M231-1W42 M231-1042

Product Directory

Improv Series Leg-Base Stacking Chairs — page 236

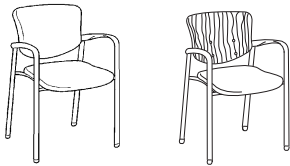

M600-2110 M600-2310

Improv Series Stools — page 242

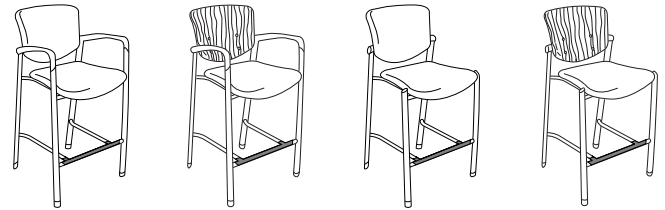

M600-8110 M600-8310 M600-8100 M600-8300

Improv Series Leg-Base Stacking Chairs without Arms — page 237

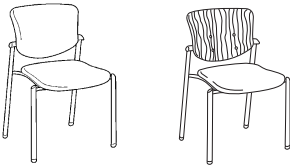

M600-2100 M600-2300

Improv Series Stacking Dolly and Book Rack — page 243

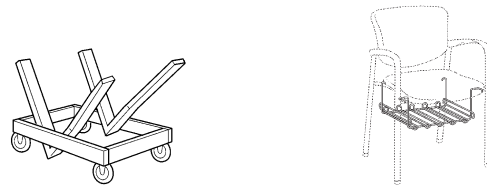

MPRV-CART MPRV-RACK

Improv Series Leg Base Chair with Tablet Arm — page 238



M600-2190

Improv Series Tandem In-Line Table — page 246

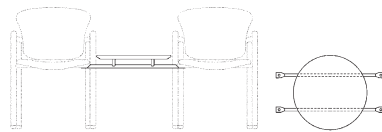

MTI1-20

Improv Series Sled-Base Chairs — pages 239-240

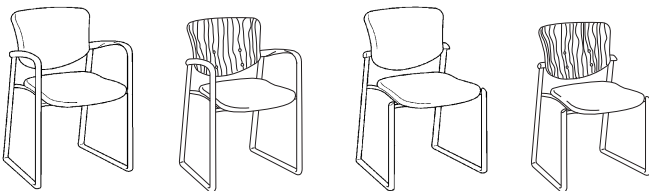

M601-2110 M601-2310 M601-2100 M601-2300

Improv Series Tandem End-of-Run Table — page 246

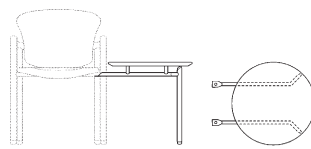

MTE1-20

Improv Series Sled-Base Chair with Tablet Arm — page 241

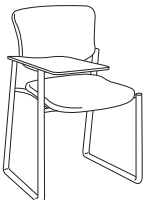

M601-2190

Improv Series Occasional Tables — page 247

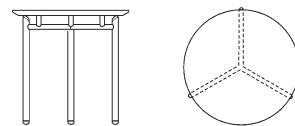

MTR1-20

LOOK High-Back Chairs — pages 251-254



Z851-1042 Z851-1442 Z851-1742 Z851-1W42

Product Directory

LOOK Mid-Back Chairs — pages 255-258



Z831-1042 Z831-1442 Z831-1742 Z831-1W42

**Wood Seating
Candor Classic Seating** — page 274



SAS-22-A1B SAS-22-A2B SAS-2W-A4B

LOOK Side Chairs — pages 259-260

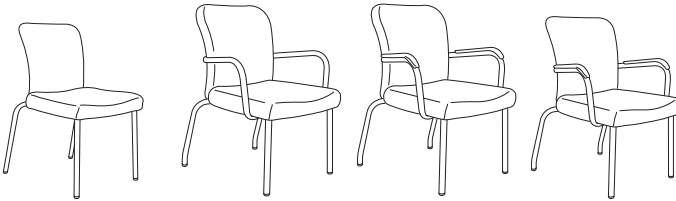

Z600-2100 Z600-2210 Z600-2230 Z600-2130

Candor Modern Seating — page 275



SAS-22-A1A SAS-22-A3A SAS-2W-A4A

LOOK Lounge Chairs — page 261



Z600-2440

Composites Arc Arm Models — page 276

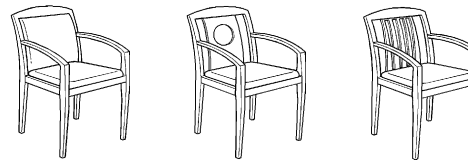

4045-00 4145-00 4245-00

Monaco High-Back Chairs — pages 265-268



D811-2240 D811-2640 D821-2240 D821-2640

Composites Repose Arm Models — page 277

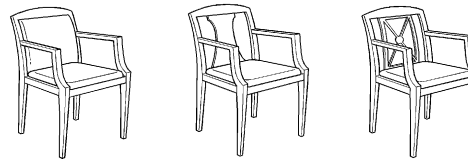

4046-00 4146-00 4246-00

Monaco Mid-Back Chairs — pages 269-272



D831-2240 D831-2640 D841-2240 D841-2640

Composites Cascade Arm Models — page 278

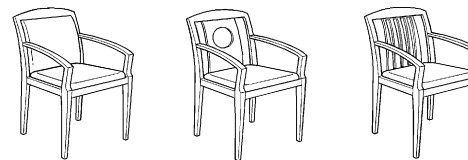

4047-00 4147-00 4247-00

Product Directory

Composites Contour Arm Models — page 279

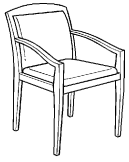

4048-00



4148-00

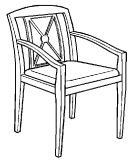

4248-00

Forenze Cabriole Arm Models — page 285



8484-00



8184-00

Composites Stacking Chairs — page 280



4043-00

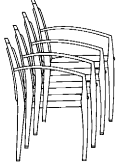

4243-00



Openest Collection Plume Screens — page 286

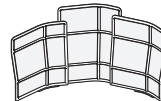

SON-3

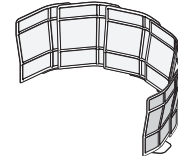

SON-6

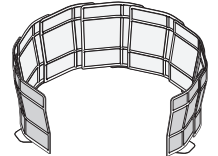

SON-9

Composites Stools — page 281

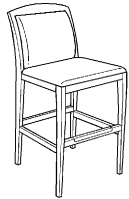

4049-00

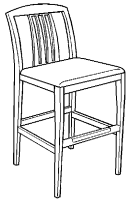

4249-00

Openest Collection Feather Sofa — page 287

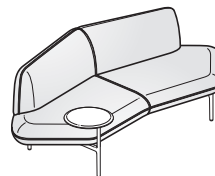

SOSS-1-RW

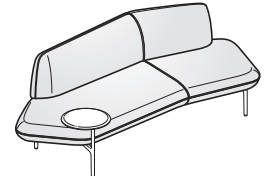

SOSR-1-RW

Forenze Serpentine Arm Models — page 282



8181-00

Openest Collection Chick Pouf — page 288

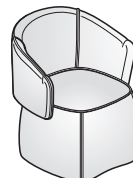

SOPB-22

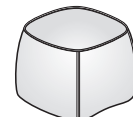

SOPN-22

Forenze Curve Arm Models — page 283



8182-00

Openest Collection Sprig Tables — page 289

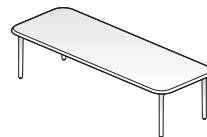

SORA-5320-P



SODC-1616-P



SODB-2424-P

Forenze Scroll Arm Models — page 284



8483-00



8183-00

Poppy — pages 292-293



SPG-11-4



SPG-11-5



SPG-11-W

Product Directory

Poppy Lounge — page 294



SLP-22-T



SLP-22-S

Hello Seating Mini-Mobile — page 302

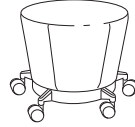

4856-0043

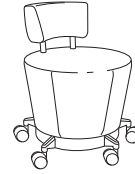

4856-0043-A

Harbor Work Lounge — pages 296-299



SHL-22-1R10



SHL-22-1R12



SHO-22-G



SHL-25-1L10



SHL-25-1L12



SHO-25-G

Hello Guest Seating/Stools — pages 303-305



4851-0011-W



4851-0011

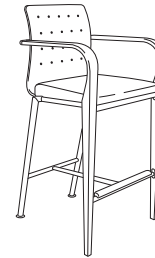

4852-0011

Hello Lounge Seating with Legs — page 300

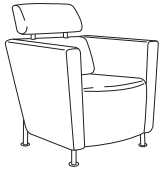

4854-0011

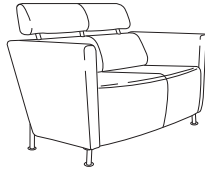

4854-0012

ToDo Stationary & Mobile Seating — pages 308-309

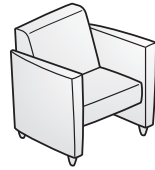

TQ84-0011

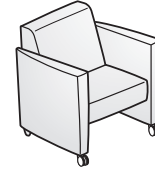

TQ85-0011

Hello Mobile Lounge Seating — page 301

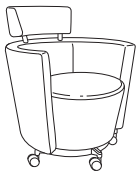

4855-0043



4855-0043-S



4855-0043-GSX

ToDo Stationary Seating — pages 310-311



TQ84-0012

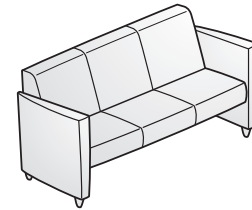

TQ84-0013

Hello Seating Accessories — page 302



4858-0001



4858-0002

ToDo Accessories — page 312

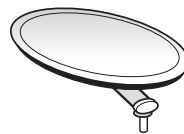

Wood Tablet
TQ90-0001

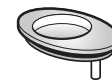

Cup Holder
TQ90-0003



Grommet Cover
TQ90-0006

Product Directory

ToDo Ottoman — page 313

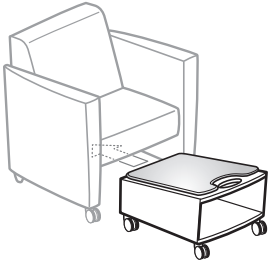

TQ90-0004

K100 Scamps Series Children's Furniture — page 314

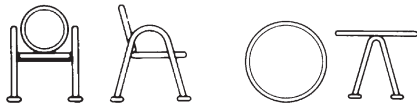

KSCP-5110

KSTR-24

Tilt Stool — page 315



STS-1

This page intentionally blank

Fern
General Specifications

General Guidelines for Product Specification

	<u>S</u>	<u>F</u>	<u>T - U</u>	<u>0 - 1</u>	<u>S</u>	<u>1</u>	<u>4</u>	<u>A</u>	<u>T</u>	<u>3A-18</u>	<u>MB-BE</u>	<u>TR-F</u>	<u>TR-TF</u>
Product Type	_____	_____	_____	_____	_____	_____	_____	_____	_____	_____	_____	_____	_____
(S) Seating													
Product Line	_____	_____	_____	_____	_____	_____	_____	_____	_____	_____	_____	_____	_____
(F) Fern													
Model (Product Type)	_____	_____	_____	_____	_____	_____	_____	_____	_____	_____	_____	_____	_____
(T) Task													
(S) Stool													
(E) Executive													
Seat (UPH)	_____	_____	_____	_____	_____	_____	_____	_____	_____	_____	_____	_____	_____
(U) Upholstery													
Back Upholstery	_____	_____	_____	_____	_____	_____	_____	_____	_____	_____	_____	_____	_____
(0) Knit													
(U) Upholstery													
Arms	_____	_____	_____	_____	_____	_____	_____	_____	_____	_____	_____	_____	_____
(0) No Arms													
(1) Fixed Arms													
(4) Height Adjustable													
(7) 4D Arms													
Arm Cap	_____	_____	_____	_____	_____	_____	_____	_____	_____	_____	_____	_____	_____
(S) Soft Cap													
(N) No Cap													
(L) Leather Cap (fixed arms only)													
Lumbar	_____	_____	_____	_____	_____	_____	_____	_____	_____	_____	_____	_____	_____
(0) No Lumbar													
(1) Lumbar													
Control	_____	_____	_____	_____	_____	_____	_____	_____	_____	_____	_____	_____	_____
(1) Pneumatic w/Back Stop													
(2) Pneumatic Synchronized Tilt													
(4) Pneumatic/Back Stop & Forward Tilt													
Seat Adjustment	_____	_____	_____	_____	_____	_____	_____	_____	_____	_____	_____	_____	_____
(A) Adjustable													
(F) Fixed													
Base & Caster Combo	_____	_____	_____	_____	_____	_____	_____	_____	_____	_____	_____	_____	_____
(1) Aluminum Hard Casters													
(2) Aluminum Soft Casters													
(T) Aluminum 2 Tone Hard Casters													
(5) Plastic Hard Casters													
(6) Plastic Soft Casters													
(7) Plastic 2 Tone Hard Casters													
(3) Aluminum Low Hard Casters													
(4) Aluminum Low Soft Casters													
Seat Upholstery	_____	_____	_____	_____	_____	_____	_____	_____	_____	_____	_____	_____	_____
Tellure													
Back Mesh	_____	_____	_____	_____	_____	_____	_____	_____	_____	_____	_____	_____	_____
Mesh													
Plastic Trim Color	_____	_____	_____	_____	_____	_____	_____	_____	_____	_____	_____	_____	_____
Plastic Model -													
(spine/wave suspension material/arm caps/levers/base)													
Aluminum Model -													
(spine/wave suspension material/arm caps/levers)													
Aluminum Trim Color	_____	_____	_____	_____	_____	_____	_____	_____	_____	_____	_____	_____	_____
Plastic Model -													
(back and arm upright/mechanism)													
Aluminum Model -													
(back and arm upright/mechanism/base)													

Fern At-A-Glance

General Specifications

Designer	Haworth Design Studio, through collaboration with ITO Design.
Fern	A revolutionary chair, backed by 16 patents and on-going research that blends science-based wellness and comfort with sustainability and international design.
Awards	2016 Best of Year award for Task Seating from Interior Design 2017 Red Dot award: Product Design
Environmental Factors	BIFMA Level 3 certified. Contains up to 95% recyclable materials. Contains 38% recycled content. Fern Task contains up to 26% post-consumer and 12% pre-consumer recycled content. Take Back Program - can be easily disassembled at the end of its useful life. Manufactured in a zero landfill, ISO 14001 certified facility in Holland, MI, USA. PED Sheet available.
Finishes and Fabrics	A complete listing of finishes and fabrics for Fern seating is available in the back of the price list.
COM & COL General Information	To order a COM fabric (Customer's Own Material) contact the Haworth Inquiry Center (1.800.462.8562), your local Haworth dealer, or go to Surfaces.haworth.com >COM library to find out if the COM you have selected has already been tested and approved. The surface collection site also has information on the Haworth+ alliance program with Carnegie, Luna Textiles, and Maharam as well as our industry-leading Pre-Approved COM program. COM fabrics are placed into Grades based on the cost per linear yard. If a fabric's cost exceeds the range of our highest Grade it will be noted as Non-Graded. The product will be priced at Grade A; the COM fabric costs will appear as a separate line item. The fabric charge will be Haworth's purchase cost plus a 4% administrative fee (based on the cost of the fabric). Yardage calculations will include any applicable fabric repeat. COM Leather products will be priced at a leather Grade A; COL costs will appear as a separate line item. The leather costs will be Haworth's purchase cost plus a 4% administrative fee (based on the cost of the leather).
Stain Repellent	Stain repellent available on seat only. To specify add "P" to the end of the product number. Example: SFT-U0-7S02A1P
Shipping Weights/Cube (Including packaging)	<ul style="list-style-type: none"> • Task Chair <ul style="list-style-type: none"> -With arms - 57 lbs. / 19.14 cubic feet -Armless - 53 lbs. / 19.14 cubic feet • Task Stool <ul style="list-style-type: none"> -With arms - 61 lbs. / 22.1 cubic feet -Armless - 57 lbs. / 22.1 cubic feet

Fern At-A-Glance

General Specifications

STANDARD MOBILITY AND ADJUSTABILITY

Seat Height Adjustment

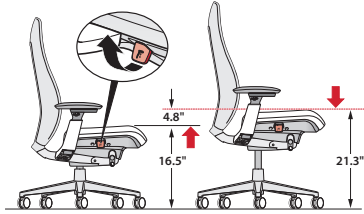

Features:

- Pneumatic seat height adjustment.
- Seat height adjusts 5"(127mm) from 16.5" to 21.5"(406mm-533mm) in standard models. Low-position adjusts from 15" to 17.5".

Benefits:

- Ensures the comfort of the lower limbs by avoiding pressure on the underside of the thigh caused by a seat pan that is too high, or decreased thigh-to-torso angle if the seat is too low.
- Accommodates users between approximately 4'11"(1499mm) and 6'3"(1905mm) tall to provide good leg circulation.
- Seat height adjustment is important in setting the proper hand position and allowing for proper sitting eye height as well.

Seat Depth Adjustment

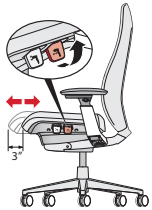

Features:

- Optional seat depth has 3"(76mm) seat depth range. Fixed seat also available.

Benefit:

- Supports the thighs, allows users to rest against the seat back for back support, and avoids pressure on the back of the knees of small to tall users.

Balanced 3-Point Tilt

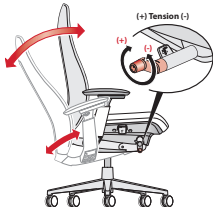

Features:

- Balanced 3-point tilt mechanism.
- Back reclines 24° from the upright position.
- Seat pan moves downward 5° from the initial position.

Benefits:

- Comfortable relaxed posture.
- Recline allows for the opening of the user's chest cavity providing good airflow to promote alertness.
- Users' feet remain flat on the floor.

Tilt Tension Control

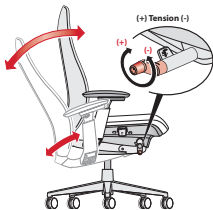

Features:

- Regulates the amount of resistance felt when leaning back in the chair and the effort required to recline the chair backwards.

Benefit:

- Personalized support to accommodate users of different body types and different work styles.

Edgeless Back Design

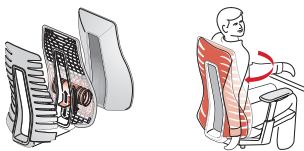

Features:

- Edgeless design provides flexibility.
- Patented design with flexible fronds and cradle system provide total back support.

Benefit:

- Encourages movement, eliminates pressure point from hard edge.

Back Support/ Lumbar Adjustment

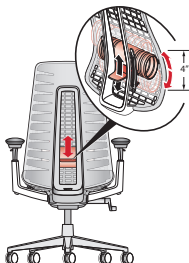

Features:

- Total back support, providing pelvic, to lumbar to thoracic support (upper back).
- Optional height adjustable lumbar.
- Range of 4" of height adjustment.

Benefits:

- Provides additional support in the lower back.
- Lumbar adjustment maintains the natural curvature of the spine at the lower back and allows users to choose the support that feels right for them.
- Integrated passive pelvic support rotates the pelvis forward to maintain the natural spine shape.

Fern At-A-Glance

General Specifications

STANDARD MOBILITY AND ADJUSTABILITY

Back Stop



Features:

- Optional Back Stop stops in 5 positions - upright and every 7° of back angle.

Benefit:

- Allows users the choice of selecting an upright position or limiting the amount of recline while performing different tasks.

Forward Tilt



Features:

- Optional forward tilt allows seat pan to move downward 5° from the initial position.

Benefit:

- Allows user the opportunity to vary their posture throughout the day.

4D Arm

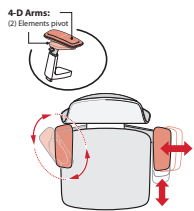

Features:

- Optional 4D arm adjusts in 4 ways:
 - Height adjustment 4.8"
 - Side-to-side arm cap adjustment range: 15" [7.5" each arm cap]
 - Front-to-back adjustment range: 3.5"(89mm)
 - Pivoting 40° in and 40° out

Benefits:

- Height adjustment offers users varying elbow rest heights so that users avoid lifting their shoulders or leaning sideways to get arm support.
- Front-to-back adjustment adjusts the armrest length, which is important because it allows users to get close to the worksurface while maintaining the effective use of the backrest.
- Side-to-side adjustment ensures a comfortable resting position for the arms with proper support of the forearm while allowing for easy entry/exit of the chair.
- Pivoting provides proper support of the forearm when performing tasks involving keying and mousing.

Height Adjustable Arm

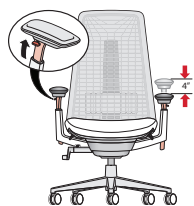

Features:

- Optional height adjustable arms adjust 4.8" vertically.

Benefit:

- Height adjustment accommodates users with varying elbow rest heights so that users avoid lifting their shoulders or leaning sideways to get arm support.

Base

Standard Plastic Base



Colors:

Fog, Black

Casters:

Hard: Black or two-tone grey

Soft: Black

Optional Aluminum Base

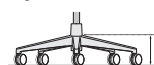

Colors:

Painted Metallic Silver, Metallic Champagne, Pitch (textured black), polished aluminum

Casters:

Hard: Black or two-tone grey

Soft: Black

Low Position Base (Aluminum only)



Colors:

Painted Metallic Silver, Metallic Champagne, Pitch (textured black)

Casters:

Hard: Black or two-tone grey

Soft: Black

Fern

General Specifications
UPHOLSTERY / AESTHETIC OPTIONS

Fern Plastic Model

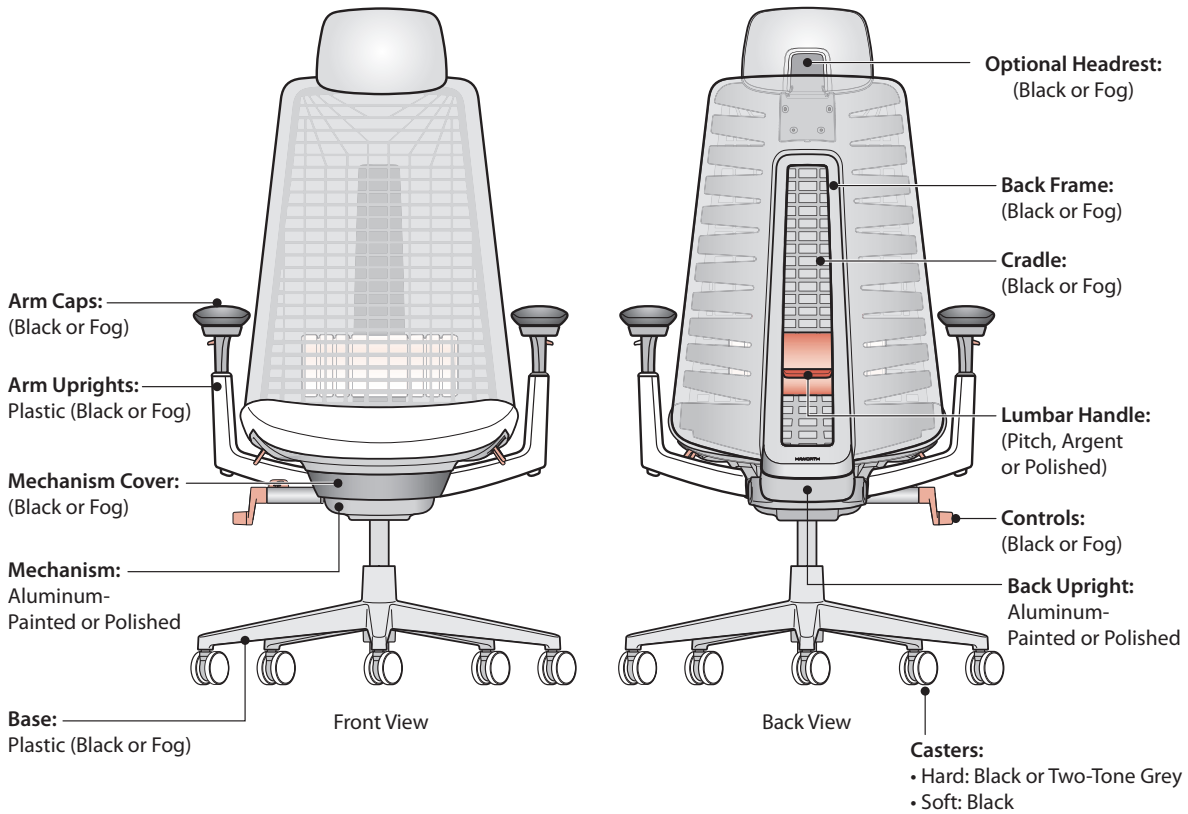

Fern Aluminum Model

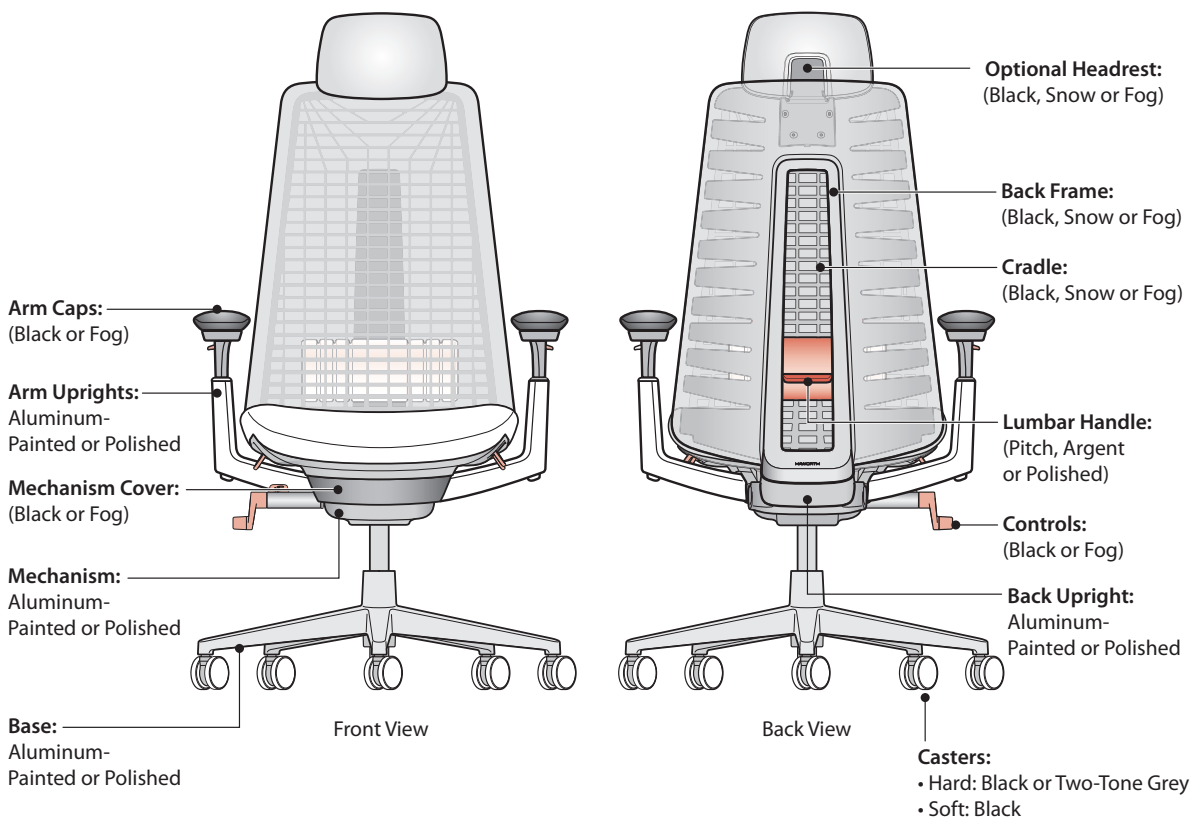

Fern Value Model

Task Chair with 4D Arms — Plastic Model



SFT-U0-7S01A5

Dimensions

- *SH: 16.5"-21.5"
(419mm-546mm)
- H: 41.5"-47"
(1054mm-1194mm)
- D: 28.5"(724mm)
- W: 29"(737mm)
- *SW: 19.9"(505mm)
- *AH: 6.7"-11.5"
(170mm-292mm)
- *SD: 15.5"-18.5"
(394mm-470mm)

* All measurements taken with the BIFMA chair measuring device.

Features

- Back: Flexible back with built in fronds wrapped in lofted mesh.
- Seat: Flexible seat pan with standard upholstered foam.
- Seat depth adjustment (3"(76mm) range).
- Base: Plastic five-star base.
- Arms: 4D arms with plastic upright.
 - Move fore, aft, side to side and pivot in and out.
 - Height adjustment range of 4.8"(122mm).
- Arm Caps: Standard with soft arm caps.
- Mechanism: Synchronized 3-point tilt; standard tilt tension adjustment.
- Height Adjustment: Pneumatic. Range: 16.5"-21.5"(419mm-546mm).
- Back Stop: 4 positions.
- Casters: Hard casters.

To Order, Specify:

- 1) Product number.
- 2) Seat surface/color: 4H-FT Blanket - Fort
- 3) Mesh back: MB-MU Mulch
- 4) Plastic trim color: TR-F Black
- 5) Aluminum trim color: TR-TF Pitch

Note: No changes to specification. No COM or Tailored Solutions.

Number	Price
SFT-U0-7S01A5	\$1146.29

Fern

Task Chair with 4D Arms — Plastic Model



SFT-U0-7S02A

1st Trim Color (Plastic)	Arm Cap/Levers	Lumbar Handle
TR-F Black	TR-F Black	TR-TF Pitch
TR-7 Fog	TR-7 Fog	TR-AR Argent

Dimensions

- *SH: 16.5"-21.5" (419mm-546mm)
- H: 41.5"-47" (1054mm-1194mm)
- D: 28.5"(724mm)
- W: 29"(737mm)
- *SW: 19.9"(505mm)
- *AH: 6.7"-11.5" (170mm-292mm)
- *SD: 15.5"-18.5" (394mm-470mm)

* All measurements taken with the BIFMA chair measuring device.

Features

- Back: Flexible back with built in fronds wrapped in lofted mesh or faux leather.
- Seat: Flexible seat pan with standard upholstered foam.
- Standard fixed seat. Optional seat depth adjustment (3"(76mm) range).
- Base: Plastic five-star base. Available in Black or Fog.
- Optional height adjustable lumbar support (4"(102mm) adjustment).
- Arms: 4D arms with plastic upright. –Move fore, aft, side to side and pivot in and out. –Height adjustment range of 4.8"(122mm).
- Arm Caps: Standard with soft arm caps.
- Optional headrest has an upholstered front with a plastic back. Headrest material and trim color are matched to the back.
- Mechanism: Synchronized 3-point tilt; standard tilt tension adjustment.
- Height Adjustment: Pneumatic. Range: 16.5"-21.5"(419mm-546mm).
- Optional Back Stop: 4 positions.
- Optional Forward Tilt (with Back Stop): 5° downward from initial position.
- Casters: Hard casters in black or two-tone grey; Soft casters black only.
- COM yardage / COL square footage: (Seat only) 0.71/8

To Order, Specify:

- 1) Product number, including;
 - 1** **Caster Option:**
 - 5** Hard Casters (Black)
 - 6** Soft Casters (Black)
 - 7** Hard Two-Tone Casters (Grey)
- 2) Fabric surface and color (seat).
- 3) Mesh or faux leather color (back).
- 4) Plastic trim color (back frame/cradle/arm uprights/arm caps/levers/base).
- 5) Aluminum trim color (back upright and mechanism). (Add **\$91.80** list for polished aluminum back upright and mechanism.)

Specification Tip

- When Polished Aluminum trim is specified, lumbar handle will default to Polished Aluminum.

Description	Number 1	Fabric Grade								Leather Grade A	Leather Grade B
		A	B	C	D	E	F	G	H		
Mesh Back, No Lumbar Adjustment											
Pneumatic w/Seat Depth Adjustment	SFT-U0-7S02A	\$1162.80	\$1197.48	\$1234.20	\$1252.56	\$1265.82	\$1298.46	\$1329.06	\$1409.64	\$1466.76	\$1611.60
Back Stop w/Seat Depth Adjustment	SFT-U0-7S01A	1244.40	1279.08	1315.80	1334.16	1347.42	1380.06	1410.66	1491.24	1548.36	1693.20
Back Stop Forward Tilt w/Seat Depth Adjustment	SFT-U0-7S04A	1326.00	1360.68	1397.40	1415.76	1429.02	1461.66	1492.26	1572.84	1629.96	1774.80
Mesh Back, Lumbar Adjustment											
Pneumatic w/Seat Depth Adjustment	SFT-U0-7S12A	\$1254.60	\$1289.28	\$1326.00	\$1344.36	\$1357.62	\$1390.26	\$1420.86	\$1501.44	\$1558.56	\$1703.40
Back Stop w/Seat Depth Adjustment	SFT-U0-7S11A	1336.20	1370.88	1407.60	1425.96	1439.22	1471.86	1502.46	1583.04	1640.16	1785.00
Back Stop Forward Tilt w/Seat Depth Adjustment	SFT-U0-7S14A	1417.80	1452.48	1489.20	1507.56	1520.82	1553.46	1584.06	1664.64	1721.76	1866.60

The following options require modification of the product number.

- Fixed seat
- Faux Leather back
- Headrest
- Stain repellent (Seat only)

To specify, change the 10th digit from an **A** to **F** and deduct **\$20.40** list; **Example:** SFT-U0-7S02F5

To specify, change the fifth digit in the product number to **U**; **Example:** SFT-UU-7S02A5 (Wellington; add **\$117.30** list, Brisa; add **\$302.94** list)

To specify, change the third digit from a **T** to an **E**; **Example:** SFE-U0-7S02A5 (Mesh; add **\$102.00** list, Faux Leather; add **\$142.80** list)

To specify, add **P** to the end of the product number and add **\$35.70** list; **Example:** SFT-U0-7S02A5P

Fern

Task Chair with 4D Arms — Aluminum Model



SFT-U0-7S02A

Dimensions

- *SH: 16.5"-21.5"
(419mm-546mm)
- H: 41.5"-47"
(1054mm-1194mm)
- D: 28.5"(724mm)
- W: 29"(737mm)
- *SW: 19.9"(505mm)
- *AH: 6.7"-11.5"
(170mm-292mm)
- *SD: 15.5"-18.5"
(394mm-470mm)

Low position seat height:
15"-17.5"
(381mm-445mm)

* All measurements taken with the BIFMA chair measuring device.

Features

- Back: Flexible back with built in fronds wrapped in lofted mesh or faux leather.
- Seat: Flexible seat pan with standard upholstered foam.
- Standard fixed seat. Optional seat depth adjustment (3"(76mm) range).
- Base: Aluminum five-star base.
- Optional height adjustable lumbar support (4"(102mm) adjustment).
- Arms: 4D arms with aluminum upright.
–Move fore, aft, side to side and pivot in and out.
–Height adjustment range of 4.8"(122mm).
- Arm Caps: Standard with soft arm caps.
- Optional headrest has an upholstered front with a plastic back. Headrest material and trim color are matched to the back.
- Mechanism: Synchronized 3-point tilt; standard tilt tension adjustment.
- Height Adjustment: Pneumatic or optional low position. Range: 15"-17.5"(381mm-445mm).
- Optional Back Stop: 4 positions.
- Optional Forward Tilt (with Back Stop): 5° downward from initial position.
- Casters: Hard casters in black or two-tone grey; Soft casters black only.
- COM yardage / COL square footage: (Seat only) 0.71/8

To Order, Specify:

- 1) Product number, including;

1 Caster Option: Standard Base

- 1** Std. Base Hard Casters (Black)
- 2** Std. Base Soft Casters (Black)
- T** Std. Base Hard Two-Tone Casters (Grey)

Low Base

- 3** Low Base, Hard Casters (Black)
- 4** Low Base, Soft Casters (Black)

- 2) Fabric surface and color (seat).
- 3) Mesh or faux leather color (back).
- 4) Plastic trim color (back frame/cradle/arm caps/levers). (Add **\$56.10** list for Snow TR-UFM for back frame/cradle.)
- 5) Aluminum trim color (back and arm upright/mechanism/base). (Add **\$91.80** list for polished aluminum.)

1st Trim Color (Plastic)	Arm Cap/Levers	Lumbar Handle
TR-F Black	TR-F Black	TR-TF Pitch
TR-7 Fog	TR-7 Fog	TR-AR Argent
TR-UFM Snow	TR-7 Fog	TR-FS Snowfall
TR-UFM Snow w/2nd trim PM-P Polished Aluminum	TR-7 Fog	PM-P Polished Aluminum

Specification Tip

- When Polished Aluminum trim is specified, lumbar handle will default to Polished Aluminum.

Description	Number ①	Fabric Grade								Leather Grade A	Leather Grade B
		A	B	C	D	E	F	G	H		
Mesh Back, No Lumbar Adjustment											
Pneumatic w/Seat Depth Adjustment	SFT-U0-7S02A	\$1317.84	\$1352.52	\$1389.24	\$1407.60	\$1420.86	\$1453.50	\$1484.10	\$1564.68	\$1621.80	\$1766.64
Back Stop w/Seat Depth Adjustment	SFT-U0-7S01A	1399.44	1434.12	1470.84	1489.20	1502.46	1535.10	1565.70	1646.28	1703.40	1848.24
Back Stop Forward Tilt w/Seat Depth Adjustment	SFT-U0-7S04A	1481.04	1515.72	1552.44	1570.80	1584.06	1616.70	1647.30	1727.88	1785.00	1929.84
Mesh Back, Lumbar Adjustment											
Pneumatic w/Seat Depth Adjustment	SFT-U0-7S12A	\$1409.64	\$1444.32	\$1481.04	\$1499.40	\$1512.66	\$1545.30	\$1575.90	\$1656.48	\$1713.60	\$1858.44
Back Stop w/Seat Depth Adjustment	SFT-U0-7S11A	1491.24	1525.92	1562.64	1581.00	1594.26	1626.90	1657.50	1738.08	1795.20	1940.04
Back Stop Forward Tilt w/Seat Depth Adjustment	SFT-U0-7S14A	1572.84	1607.52	1644.24	1662.60	1675.86	1708.50	1739.10	1819.68	1876.80	2021.64

The following options require modification of the product number.

- Fixed seat To specify, change the 10th digit from an **A** to **F** and deduct **\$20.40** list; **Example:** SFT-U0-7S02F1
- Faux Leather back To specify, change the fifth digit in the product number to **U**; **Example:** SFT-UU-7S02A1 (Wellington; add **\$117.30** list, Brisa; add **\$302.94** list)
- Headrest To specify, change the third digit from a **T** to an **E**; **Example:** SFE-U0-7S02A1 (Mesh; add **\$102.00** list, Faux Leather; add **\$142.80** list)
- Stain repellent (Seat only) To specify, add **P** to the end of the product number and add **\$35.70** list; **Example:** SFT-U0-7S02A1P

Fern

Task Chair with Height Adjustable Arms — Plastic Model



SFT-U0-4S02A

1st Trim Color (Plastic)	Arm Cap/Levers	Lumbar Handle
TR-F Black	TR-F Black	TR-TF Pitch
TR-7 Fog	TR-7 Fog	TR-AR Argent

Dimensions

- *SH: 16.5"-21.5" (419mm-546mm)
- H: 41.5"-47" (1054mm-1194mm)
- D: 28.5"(724mm)
- W: 29"(737mm)
- *SW: 19.9"(505mm)
- *AH: 6.7"-11.5" (170mm-292mm)
- *SD: 15.5"-18.5" (394mm-470mm)

* All measurements taken with the BIFMA chair measuring device.

Features

- Back: Flexible back with built in fronds wrapped in lofted mesh or faux leather.
- Seat: Flexible seat pan with standard upholstered foam.
- Standard fixed seat. Optional seat depth adjustment (3"(76mm) range).
- Base: Plastic five-star base. Available in Black or Fog.
- Optional height adjustable lumbar support (4"(102mm) adjustment).
- Arms: Height Adjustable with soft arm caps. Adjustment range of 4.8"(122mm).
- Optional headrest has an upholstered front with a plastic back. Headrest material and trim color are matched to the back.
- Mechanism: Synchronized 3-point tilt; standard tilt tension adjustment.
- Height Adjustment: Pneumatic. Range: 16.5"-21.5"(419mm-546mm).
- Optional Back Stop: 4 positions.
- Optional Forward Tilt (with Back Stop): 5° downward from initial position.
- Casters: Hard casters in black or two-tone grey; Soft casters black only.
- COM yardage / COL square footage: (Seat only) 0.71/8

To Order, Specify:

- 1) Product number, including;
 - 1** **Caster Option:**
 - 5** Hard Casters (Black)
 - 6** Soft Casters (Black)
 - 7** Hard Two-Tone Casters (Grey)
- 2) Fabric surface and color (seat).
- 3) Mesh or faux leather color (back).
- 4) Plastic trim color (back frame/cradle/arm uprights/arm caps/levers/base).
- 5) Aluminum trim color (back upright and mechanism). (Add **\$91.80** list for polished aluminum back upright and mechanism.)

Specification Tip

- When Polished Aluminum trim is specified, lumbar handle will default to Polished Aluminum.

Description	Number 1	Fabric Grade								Leather Grade A	Leather Grade B
		A	B	C	D	E	F	G	H		
Mesh Back, No Lumbar Adjustment											
Pneumatic w/Seat Depth Adjustment	SFT-U0-4S02A	\$1137.30	\$1171.98	\$1208.70	\$1227.06	\$1240.32	\$1272.96	\$1303.56	\$1384.14	\$1441.26	\$1586.10
Back Stop w/Seat Depth Adjustment	SFT-U0-4S01A	1218.90	1253.58	1290.30	1308.66	1321.92	1354.56	1385.16	1465.74	1522.86	1667.70
Back Stop Forward Tilt w/Seat Depth Adjustment	SFT-U0-4S04A	1300.50	1335.18	1371.90	1390.26	1403.52	1436.16	1466.76	1547.34	1604.46	1749.30
Mesh Back, Lumbar Adjustment											
Pneumatic w/Seat Depth Adjustment	SFT-U0-4S12A	\$1229.10	\$1263.78	\$1300.50	\$1318.86	\$1332.12	\$1364.76	\$1395.36	\$1475.94	\$1533.06	\$1677.90
Back Stop w/Seat Depth Adjustment	SFT-U0-4S11A	1310.70	1345.38	1382.10	1400.46	1413.72	1446.36	1476.96	1557.54	1614.66	1759.50
Back Stop Forward Tilt w/Seat Depth Adjustment	SFT-U0-4S14A	1392.30	1426.98	1463.70	1482.06	1495.32	1527.96	1558.56	1639.14	1696.26	1841.10

The following options require modification of the product number.

- Fixed seat To specify, change the 10th digit from an **A** to **F** and deduct **\$20.40** list; **Example:** SFT-U0-4S02F5
- Faux Leather back To specify, change the fifth digit in the product number to **U**; **Example:** SFT-UU-4S02A5 (Wellington; add **\$117.30** list, Brisa; add **\$302.94** list)
- Headrest To specify, change the third digit from a **T** to an **E**; **Example:** SFE-U0-4S02A5 (Mesh; add **\$102.00** list, Faux Leather; add **\$142.80** list)
- Stain repellent (Seat only) To specify, add **P** to the end of the product number and add **\$35.70** list; **Example:** SFT-U0-4S02A5P

Fern

Task Chair with Height Adjustable Arms — Aluminum Model



SFT-U0-4S02A

Dimensions

- *SH: 16.5"-21.5"
(419mm-546mm)
- H: 41.5"-47"
(1054mm-1194mm)
- D: 28.5"(724mm)
- W: 29"(737mm)
- *SW: 19.9"(505mm)
- *AH: 6.7"-11.5"
(170mm-292mm)
- *SD: 15.5"-18.5"
(394mm-470mm)

Low position seat height:
15"-17.5"
(381mm-445mm)

* All measurements taken with the BIFMA chair measuring device.

Features

- Back: Flexible back with built in fronds wrapped in lofted mesh or faux leather.
- Seat: Flexible seat pan with standard upholstered foam.
- Standard fixed seat. Optional seat depth adjustment (3"(76mm) range).
- Base: Aluminum five-star base.
- Optional height adjustable lumbar support (4"(102mm) adjustment).
- Arms: Height Adjustable with soft arm caps. Adjustment range of 4.8"(122mm).
- Optional headrest has an upholstered front with a plastic back. Headrest material and trim color are matched to the back.
- Mechanism: Synchronized 3-point tilt; standard tilt tension adjustment.
- Height Adjustment: Pneumatic or optional low position. Range: 15"-17.5"(381mm-445mm).
- Optional Back Stop: 4 positions.
- Optional Forward Tilt (with Back Stop): 5° downward from initial position.
- Casters: Hard casters in black or two-tone grey; Soft casters black only.
- COM yardage / COL square footage: (Seat only) 0.71/8

To Order, Specify:

1) Product number, including;

1 Caster Option: Standard Base

- 1** Std. Base Hard Casters (Black)
- 2** Std. Base Soft Casters (Black)
- T** Std. Hard Base Two-Tone Casters (Grey)

Low Base

- 3** Low Base, Hard Casters (Black)
- 4** Low Base, Soft Casters (Black)

- 2) Fabric surface and color (seat).
- 3) Mesh or faux leather color (back).
- 4) Plastic trim color (back frame/cradle/arm caps/levers). (Add **\$56.10** list for Snow TR-UFM for back frame/cradle.)
- 5) Aluminum trim color (back and arm upright/mechanism/base). (Add **\$91.80** list for polished aluminum.)

1st Trim Color (Plastic)	Arm Cap/Levers	Lumbar Handle
TR-F Black	TR-F Black	TR-TF Pitch
TR-7 Fog	TR-7 Fog	TR-AR Argent
TR-UFM Snow	TR-7 Fog	TR-FS Snowfall
TR-UFM Snow w/2nd trim PM-P Polished Aluminum	TR-7 Fog	PM-P Polished Aluminum

Specification Tip

- When Polished Aluminum trim is specified, lumbar handle will default to Polished Aluminum.

Description	Number 1	Fabric Grade								Leather Grade A	Leather Grade B
		A	B	C	D	E	F	G	H		
Mesh Back, No Lumbar Adjustment											
Pneumatic w/Seat Depth Adjustment	SFT-U0-4S02A	\$1292.34	\$1327.02	\$1363.74	\$1382.10	\$1395.36	\$1428.00	\$1458.60	\$1539.18	\$1596.30	\$1741.14
Back Stop w/Seat Depth Adjustment	SFT-U0-4S01A	1373.94	1408.62	1445.34	1463.70	1476.96	1509.60	1540.20	1620.78	1677.90	1822.74
Back Stop Forward Tilt w/Seat Depth Adjustment	SFT-U0-4S04A	1455.54	1490.22	1526.94	1545.30	1558.56	1591.20	1621.80	1702.38	1759.50	1904.34
Mesh Back, Lumbar Adjustment											
Pneumatic w/Seat Depth Adjustment	SFT-U0-4S12A	\$1384.14	\$1418.82	\$1455.54	\$1473.90	\$1487.16	\$1519.80	\$1550.40	\$1630.98	\$1688.10	\$1832.94
Back Stop w/Seat Depth Adjustment	SFT-U0-4S11A	1465.74	1500.42	1537.14	1555.50	1568.76	1601.40	1632.00	1712.58	1769.70	1914.54
Back Stop Forward Tilt w/Seat Depth Adjustment	SFT-U0-4S14A	1547.34	1582.02	1618.74	1637.10	1650.36	1683.00	1713.60	1794.18	1851.30	1996.14

The following options require modification of the product number.

- Fixed seat To specify, change the 10th digit from an **A** to **F** and deduct **\$20.40** list; **Example:** SFT-U0-4S02F1
- Faux Leather back To specify, change the fifth digit in the product number to **U**; **Example:** SFT-UU-4S02A1 (Wellington; add **\$117.30** list, Brisa; add **\$302.94** list)
- Headrest To specify, change the third digit from a **T** to an **E**; **Example:** SFE-U0-4S02A1 (Mesh; add **\$102.00** list, Faux Leather; add **\$142.80** list)
- Stain repellent (Seat only) To specify, add **P** to the end of the product number and add **\$35.70** list; **Example:** SFT-U0-4S02A1P

Fern

Task Chair with Fixed Arms — Plastic Model



SFT-U0-1S02A

1st Trim Color (Plastic)	Arm Cap/Levers	Lumbar Handle
TR-F Black	TR-F Black	TR-TF Pitch
TR-7 Fog	TR-7 Fog	TR-AR Argent

Dimensions

- *SH: 16.5"-21.5" (419mm-546mm)
- H: 41.5"-47" (1054mm-1194mm)
- D: 28.5"(724mm)
- W: 29"(737mm)
- *SW: 19.9"(505mm)
- *AH: 9"(229mm)
- *SD: 15.5"-18.5" (394mm-470mm)

* All measurements taken with the BIFMA chair measuring device.

Features

- Back: Flexible back with built in fronds wrapped in lofted mesh or faux leather.
- Seat: Flexible seat pan with standard upholstered foam.
- Standard fixed seat. Optional seat depth adjustment (3"(76mm) range).
- Base: Plastic five-star base. Available in Black or Fog.
- Optional height adjustable lumbar support (4"(102mm) adjustment).
- Arms: Fixed aluminum arms with soft arm caps.
- Optional leather arm cap available when ordering a leather seat. Leather arm cap coordinates with leather seat selection.
- Optional headrest has an upholstered front with a plastic back. Headrest material and trim color are matched to the back.
- Mechanism: Synchronized 3-point tilt; standard tilt tension adjustment.
- Height Adjustment: Pneumatic. Range: 15"-17.5"(381mm-445mm).
- Optional Back Stop: 4 positions.
- Optional Forward Tilt (with Back Stop): 5° downward from initial position.
- Casters: Hard casters in black or two-tone grey; Soft casters black only.
- COM yardage / COL square footage: (Seat only) 0.71/8

To Order, Specify:

- 1) Product number, including;
 - 1 Caster Option:**
 - 5** Hard Casters (Black)
 - 6** Soft Casters (Black)
 - 7** Hard Two-Tone Casters (Grey)
- 2) Fabric surface and color (seat).
- 3) Mesh or faux leather color (back).
- 4) Plastic trim color (back frame/cradle/arm caps/levers/base).
- 5) Aluminum trim color (back upright/arm uprights/mechanism). (Add **\$91.80** list for polished aluminum back upright and mechanism.)

Specification Tip

- When Polished Aluminum trim is specified, lumbar handle will default to Polished Aluminum.

Description	Number 1	Fabric Grade								Leather Grade A	Leather Grade B
		A	B	C	D	E	F	G	H		
Mesh Back, No Lumbar Adjustment											
Pneumatic w/Seat Depth Adjustment	SFT-U0-1S02A	\$1122.00	\$1156.68	\$1193.40	\$1211.76	\$1225.02	\$1257.66	\$1288.26	\$1368.84	\$1425.96	\$1570.80
Back Stop w/Seat Depth Adjustment	SFT-U0-1S01A	1203.60	1238.28	1275.00	1293.36	1306.62	1339.26	1369.86	1450.44	1507.56	1652.40
Back Stop Forward Tilt w/Seat Depth Adjustment	SFT-U0-1S04A	1285.20	1319.88	1356.60	1374.96	1388.22	1420.86	1451.46	1532.04	1589.16	1734.00
Mesh Back, Lumbar Adjustment											
Pneumatic w/Seat Depth Adjustment	SFT-U0-1S12A	\$1213.80	\$1248.48	\$1285.20	\$1303.56	\$1316.82	\$1349.46	\$1380.06	\$1460.64	\$1517.76	\$1662.60
Back Stop w/Seat Depth Adjustment	SFT-U0-1S11A	1295.40	1330.08	1366.80	1385.16	1398.42	1431.06	1461.66	1542.24	1599.36	1744.20
Back Stop Forward Tilt w/Seat Depth Adjustment	SFT-U0-1S14A	1377.00	1411.68	1448.40	1466.76	1480.02	1512.66	1543.26	1623.84	1680.96	1825.80

The following options require modification of the product number.

- | | |
|-----------------------------|---|
| Fixed seat | To specify, change the 10th digit from an A to F and deduct \$20.40 list; Example: SFT-U0-1S02F5 |
| Leather arm cap | To specify, change the 7th digit from S to L ; Example: SFT-U0-1L02A5 (matches required Leather seat), add \$71.40 list |
| Faux Leather back | To specify, change the fifth digit in the product number to U ; Example: SFT-UU-1S02A5 (Wellington); add \$117.30 list, Brisa; add \$302.94 list) |
| Headrest | To specify, change the third digit from a T to an E ; Example: SFE-U0-1S02A5 (Mesh; add \$102.00 list, Faux Leather; add \$142.80 list) |
| Stain repellent (Seat only) | To specify, add P to the end of the product number and add \$35.70 list; Example: SFT-U0-1S02A5P |

Fern

Task Chair with Fixed Arms — Aluminum Model



SFT-U0-1S02A

Dimensions

- *SH: 16.5"-21.5"
(419mm-546mm)
- H: 41.5"-47"
(1054mm-1194mm)
- D: 28.5"(724mm)
- W: 29"(737mm)
- *SW: 19.9"(505mm)
- *AH: 9"(229mm)
- *SD: 15.5"-18.5"
(394mm-470mm)

Low position seat height:
15"-17.5"(381mm-445mm)

* All measurements taken with the BIFMA chair measuring device.

Features

- Back: Flexible back with built in fronds wrapped in lofted mesh or faux leather.
- Seat: Flexible seat pan with standard upholstered foam.
- Standard fixed seat. Optional seat depth adjustment (3"(76mm) range).
- Base: Aluminum five-star base.
- Optional height adjustable lumbar support (4"(102mm) adjustment).
- Arms: Fixed with soft arm caps.
- Optional leather arm cap available when ordering a leather seat. Leather arm cap coordinates with leather seat selection.
- Optional headrest has an upholstered front with a plastic back. Headrest material and trim color are matched to the back.
- Mechanism: Synchronized 3-point tilt; standard tilt tension adjustment.
- Height Adjustment: Pneumatic or optional low position. Range: 15"-17.5"(381mm-445mm).
- Optional Back Stop: 4 positions.
- Optional Forward Tilt (with Back Stop): 5° downward from initial position.
- Casters: Hard casters in black or two-tone grey; Soft casters black only.
- COM yardage / COL square footage: (Seat only) 0.71/8

To Order, Specify:

- 1) Product number, including;

1 Caster Option: Standard Base

- 1** Std. Base Hard Casters (Black)
- 2** Std. Base Soft Casters (Black)
- T** Std. Base Hard Two-Tone Casters (Grey)

Low Base

- 3** Low Base, Hard Casters (Black)
- 4** Low Base, Soft Casters (Black)

- 2) Fabric surface and color (seat).
- 3) Mesh or faux leather color (back).
- 4) Plastic trim color (back frame/cradle/arm caps/levers). (Add **\$56.10** list for Snow TR-UFM for back frame/cradle/arm caps.)
- 5) Aluminum trim color (back and arm upright/mechanism/base). (Add **\$91.80** list for polished aluminum back upright and mechanism.)

1st Trim Color (Plastic)	Arm Cap/Levers	Lumbar Handle
TR-F Black	TR-F Black	TR-TF Pitch
TR-7 Fog	TR-7 Fog	TR-AR Argent
TR-UFM Snow	TR-7 Fog	TR-FS Snowfall
TR-UFM Snow w/2nd trim PM-P Polished Aluminum	TR-7 Fog	PM-P Polished Aluminum

Specification Tip

- When Polished Aluminum trim is specified, lumbar handle will default to Polished Aluminum.

Description	Number	①	Fabric Grade								Leather Grade A	Leather Grade B
			A	B	C	D	E	F	G	H		
Mesh Back, No Lumbar Adjustment												
Pneumatic w/Seat Depth Adjustment	SFT-U0-1S02A		\$1277.04	\$1311.72	\$1348.44	\$1366.80	\$1380.06	\$1412.70	\$1443.30	\$1523.88	\$1581.00	\$1725.84
Back Stop w/Seat Depth Adjustment	SFT-U0-1S01A		1358.64	1393.32	1430.04	1448.40	1461.66	1494.30	1524.90	1605.48	1662.60	1807.44
Back Stop Forward Tilt w/Seat Depth Adjustment	SFT-U0-1S04A		1440.24	1474.92	1511.64	1530.00	1543.26	1575.90	1606.50	1687.08	1744.20	1889.04
Mesh Back, Lumbar Adjustment												
Pneumatic w/Seat Depth Adjustment	SFT-U0-1S12A		\$1368.84	\$1403.52	\$1440.24	\$1458.60	\$1471.86	\$1504.50	\$1535.10	\$1615.68	\$1672.80	\$1817.64
Back Stop w/Seat Depth Adjustment	SFT-U0-1S11A		1450.44	1485.12	1521.84	1540.20	1553.46	1586.10	1616.70	1697.28	1754.40	1899.24
Back Stop Forward Tilt w/Seat Depth Adjustment	SFT-U0-1S14A		1532.04	1566.72	1603.44	1621.80	1635.06	1667.70	1698.30	1778.88	1836.00	1980.84

The following options require modification of the product number.

- Fixed seat To specify, change the 10th digit from an **A** to **F** and deduct **\$20.40** list; **Example:** SFT-U0-1S02F1
- Leather arm cap To specify, change the 7th digit from **S** to **L**; **Example:** SFT-U0-1L02A1 (matches required Leather seat), add **\$71.40** list
- Faux Leather back To specify, change the fifth digit in the product number to **U**; **Example:** SFT-UU-1S02A1 (Wellington; add **\$117.30** list, Brisa; add **\$302.74** list)
- Headrest To specify, change the third digit from a **T** to an **E**; **Example:** SFE-U0-1S02A1 (Mesh; add **\$102.00** list, Faux Leather; add **\$142.80** list)
- Stain repellent (Seat only) To specify, add **P** to the end of the product number and add **\$35.70** list; **Example:** SFT-U0-1S02A1P

Fern

Task Chair without Arms — Plastic Model



SFT-U0-0N02A

Dimensions

- *SH: 16.5"-21.5"
(419mm-546mm)
- H: 41.5"-47"
(1054mm-1194mm)
- D: 28.5"(724mm)
- W: 29"(737mm)
- *SW: 19.9"(505mm)
- *SD: 15.5"-18.5"
(394mm-470mm)

* All measurements taken with the BIFMA chair measuring device.

Features

- Back: Flexible back with built in fronds wrapped in lofted mesh or faux leather.
- Seat: Flexible seat pan with standard upholstered foam.
- Standard fixed seat. Optional seat depth adjustment (3"(76mm) range).
- Base: Plastic five-star base. Available in Black or Fog.
- Optional height adjustable lumbar support (4"(102mm) adjustment).
- Optional headrest has an upholstered front with a plastic back. Headrest material and trim color are matched to the back.
- Mechanism: Synchronized 3-point tilt; standard tilt tension adjustment.
- Height Adjustment: Pneumatic. Range: 16.5"-21.5"(419mm-546mm).
- Optional Back Stop: 4 positions.
- Optional Forward Tilt (with Back Stop): 5° downward from initial position.
- Casters: Hard casters in black or two-tone grey; Soft casters black only.
- COM yardage / COL square footage: (Seat only) 0.71/8

To Order, Specify:

- 1) Product number, including;
 - 1** Caster Option:
 - 5** Hard Casters (Black)
 - 6** Soft Casters (Black)
 - 7** Hard Two-Tone Casters (Grey)
- 2) Fabric surface and color (seat).
- 3) Mesh or faux leather color (back).
- 4) Plastic trim color (back frame/cradle/ levers/base).
- 5) Aluminum trim color (back upright and mechanism). (Add **\$91.80** list for polished aluminum back upright and mechanism.)

1st Trim Color (Plastic)	Levers	Lumbar Handle
TR-F Black	TR-F Black	TR-TF Pitch
TR-7 Fog	TR-7 Fog	TR-AR Argent

Specification Tip

- When Polished Aluminum trim is specified, lumbar handle will default to Polished Aluminum.

Description	Number	1	Fabric Grade								Leather Grade A	Leather Grade B
			A	B	C	D	E	F	G	H		
Mesh Back, No Lumbar Adjustment												
Pneumatic w/Seat Depth Adjustment	SFT-U0-0N02A		\$ 999.60	\$1034.28	\$1071.00	\$1089.36	\$1102.62	\$1135.26	\$1165.86	\$1246.44	\$1303.56	\$1448.40
Back Stop w/Seat Depth Adjustment	SFT-U0-0N01A		1081.20	1115.88	1152.60	1170.96	1184.22	1216.86	1247.46	1328.04	1385.16	1530.00
Back Stop Forward Tilt w/Seat Depth Adjustment	SFT-U0-0N04A		1162.80	1197.48	1234.20	1252.56	1265.82	1298.46	1329.06	1409.64	1466.76	1611.60
Mesh Back, Lumbar Adjustment												
Pneumatic w/Seat Depth Adjustment	SFT-U0-0N12A		\$1091.40	\$1126.08	\$1162.80	\$1181.16	\$1194.42	\$1227.06	\$1257.66	\$1338.24	\$1395.36	\$1540.20
Back Stop w/Seat Depth Adjustment	SFT-U0-0N11A		1173.00	1207.68	1244.40	1262.76	1276.02	1308.66	1339.26	1419.84	1476.96	1621.80
Back Stop Forward Tilt w/Seat Depth Adjustment	SFT-U0-0N14A		1254.60	1289.28	1326.00	1344.36	1357.62	1390.26	1420.86	1501.44	1558.56	1703.40

The following options require modification of the product number.

- | | |
|-----------------------------|--|
| Fixed seat | To specify, change the 10th digit from an A to F and deduct \$20.40 list; Example: SFT-U0-0N02F5 |
| Faux Leather back | To specify, change the fifth digit in the product number to U ; Example: SFT-UU-0N02A5 (Wellington; add \$117.30 list, Brisa; add \$302.94 list) |
| Headrest | To specify, change the third digit from a T to an E ; Example: SFE-U0-0N02A5 (Mesh; add \$102.00 list, Faux Leather; add \$142.80 list) |
| Stain repellent (Seat only) | To specify, add P to the end of the product number and add \$35.70 list; Example: SFT-U0-0N02A5P |

Fern

Task Chair without Arms — Aluminum Model

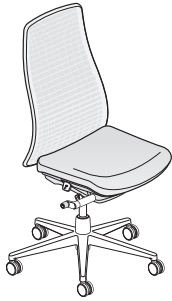

SFT-U0-0N02A

Dimensions

- *SH: 16.5"-21.5"
(419mm-546mm)
- H: 41.5"-47"
(1054mm-1194mm)
- D: 28.5"(724mm)
- W: 29"(737mm)
- *SW: 19.9"(505mm)
- *SD: 15.5"-18.5"
(394mm-470mm)

Low position seat height:
15"-17.5"(381mm-445mm)

* All measurements taken with the BIFMA chair measuring device.

Features

- Back: Flexible back with built in fronds wrapped in lofted mesh or faux leather.
- Seat: Flexible seat pan with standard upholstered foam.
- Standard fixed seat. Optional seat depth adjustment (3"(76mm) range).
- Base: Aluminum five-star base.
- Optional height adjustable lumbar support (4"(102mm) adjustment).
- Optional headrest has an upholstered front with a plastic back. Headrest material and trim color are matched to the back.
- Mechanism: Synchronized 3-point tilt; standard tilt tension adjustment.
- Height Adjustment: Pneumatic or optional low position. Range: 15"-17.5"(381mm-445mm).
- Optional Back Stop: 4 positions.
- Optional Forward Tilt (with Back Stop): 5° downward from initial position.
- Casters: Hard casters in black or two-tone grey; Soft casters black only.
- COM yardage / COL square footage: (Seat only) 0.71/8

To Order, Specify:

1) Product number, including;

1 Caster Option: Standard Base

- 1** Std. Base Hard Casters (Black)
- 2** Std. Base Soft Casters (Black)
- T** Std. Base Hard Two-Tone Casters (Grey)

Low Base

- 3** Low Base, Hard Casters (Black)
- 4** Low Base, Soft Casters (Black)

- 2) Fabric surface and color (seat).
- 3) Mesh or faux leather color (back).
- 4) Plastic trim color (back frame/cradle/levers). (Add **\$56.10** list for Snow TR-UFM for back frame/cradle.)
- 5) Aluminum trim color (back upright/mechanism/base). (Add **\$91.80** list for polished aluminum back upright and mechanism.)

1st Trim Color (Plastic)	Levers	Lumbar Handle
TR-F Black	TR-F Black	TR-TF Pitch
TR-7 Fog	TR-7 Fog	TR-AR Argent
TR-UFM Snow	TR-7 Fog	TR-FS Snowfall
TR-UFM Snow w/2nd trim PM-P Polished Aluminum	TR-7 Fog	PM-P Polished Aluminum

Specification Tip

- When Polished Aluminum trim is specified, lumbar handle will default to Polished Aluminum.

Description	Number	1	Fabric Grade								Leather Grade A	Leather Grade B
			A	B	C	D	E	F	G	H		
Mesh Back, No Lumbar Adjustment												
Pneumatic w/Seat Depth Adjustment	SFT-U0-0N02A		\$1154.64	\$1189.32	\$1226.04	\$1244.40	\$1257.66	\$1290.30	\$1320.90	\$1401.48	\$1458.60	\$1603.44
Back Stop w/Seat Depth Adjustment	SFT-U0-0N01A		1236.24	1270.92	1307.64	1326.00	1339.26	1371.90	1402.50	1483.08	1540.20	1685.04
Back Stop Forward Tilt w/Seat Depth Adjustment	SFT-U0-0N04A		1317.84	1352.52	1389.24	1407.60	1420.86	1453.50	1484.10	1564.68	1621.80	1766.64
Mesh Back, Lumbar Adjustment												
Pneumatic w/Seat Depth Adjustment	SFT-U0-0N12A		\$1246.44	\$1281.12	\$1317.84	\$1336.20	\$1349.46	\$1382.10	\$1412.70	\$1493.28	\$1550.40	\$1695.24
Back Stop w/Seat Depth Adjustment	SFT-U0-0N11A		1328.04	1362.72	1399.44	1417.80	1431.06	1463.70	1494.30	1574.88	1632.00	1776.84
Back Stop Forward Tilt w/Seat Depth Adjustment	SFT-U0-0N14A		1409.64	1444.32	1481.04	1499.40	1512.66	1545.30	1575.90	1656.48	1713.60	1858.44

The following options require modification of the product number.

- Fixed seat To specify, change the 10th digit from an **A** to **F** and deduct **\$20.40** list; **Example:** SFT-U0-0N02F1
- Faux Leather back To specify, change the fifth digit in the product number to **U**; **Example:** SFT-UU-0N02A1 (Wellington; add **\$117.30** list, Brisa; add **\$302.94** list)
- Headrest To specify, change the third digit from a **T** to an **E**; **Example:** SFE-U0-0N02A1 (Mesh; add **\$102.00** list, Faux Leather; add **\$142.80** list)
- Stain repellent (Seat only) To specify, add **P** to the end of the product number and add **\$35.70** list; **Example:** SFT-U0-0N02A1P

Fern

Task Stool with 4D Arms — Plastic Model



SFS-U0-7502A

1st Trim Color (Plastic)	Arm Cap/Levers	Lumbar Handle
TR-F Black	TR-F Black	TR-TF Pitch
TR-7 Fog	TR-7 Fog	TR-AR Argent

Dimensions

- *SH: 21.75"-29.25"
(552mm-743mm)
- H: 46.75"-54.75"
(1187mm-1391mm)
- D: 28.5"(724mm)
- W: 29"(737mm)
- *SW: 19.9"(505mm)
- *AH: 6.7"-11.5"
(170mm-292mm)
- *SD: 15.5"-18.5"
(394mm-470mm)

* All measurements taken with the BIFMA chair measuring device.

Features

- Back: Flexible back with built in fronds wrapped in lofted mesh or faux leather.
- Seat: Flexible seat pan with standard upholstered foam.
- Standard fixed seat. Optional seat depth adjustment (3"(76mm) range).
- Optional height adjustable lumbar support (4"(102mm) adjustment).
- Arms: 4D arms with plastic upright.
 - Move fore, aft, side to side and pivot in and out.
 - Height adjustment range of 4.8"(122mm).
- Arm Caps: Standard with soft arm caps.
- Mechanism: Synchronized 3-point tilt; standard tilt tension adjustment.
- Height Adjustment: Pneumatic. Range: 21.75"-29.25"(552mm-743mm).
- Optional Back Stop: 4 positions.
- Base: Plastic five-star base.
- Footring: Adjusts 4"(102mm) up and down. Brushed aluminum finish.
- Casters: Hard casters in black or two-tone grey; Soft casters black only.
- COM yardage / COL square footage:
(Seat only) 0.71/8

To Order, Specify:

- 1) Product number, including;

1 Caster Option:

- 5** Hard Casters (Black)
- 6** Soft Casters (Black)
- 7** Hard Two-Tone Casters (Grey)

- 2) Fabric surface and color (seat).
- 3) Mesh or faux leather color (back).
- 4) Plastic trim color for back frame/cradle/arm uprights/arm caps/levers/base.
- 5) Aluminum trim color for back upright and mechanism.
(Add **\$91.80** list for polished aluminum back upright and mechanism.)

Specification Tip

- When Polished Aluminum trim is specified, lumbar handle will default to Polished Aluminum.

Description	Number	Fabric Grade								Leather Grade A	Leather Grade B	
		1	A	B	C	D	E	F	G			H
Mesh Back, No Lumbar Adjustment												
Pneumatic w/Seat Depth Adjustment	SFS-U0-7502A		\$1572.84	\$1607.52	\$1644.24	\$1662.60	\$1675.86	\$1708.50	\$1739.10	\$1819.68	\$1876.80	\$2021.64
Back Stop w/Seat Depth Adjustment	SFS-U0-7501A		1654.44	1689.12	1725.84	1744.20	1757.46	1790.10	1820.70	1901.28	1958.40	2103.24
Mesh Back, Lumbar Adjustment												
Pneumatic w/Seat Depth Adjustment	SFS-U0-7512A		\$1664.64	\$1699.32	\$1736.04	\$1754.40	\$1767.66	\$1800.30	\$1830.90	\$1911.48	\$1968.60	\$2113.44
Back Stop w/Seat Depth Adjustment	SFS-U0-7511A		1746.24	1780.92	1817.64	1836.00	1849.26	1881.90	1912.50	1993.08	2050.20	2195.04

The following options require modification of the product number.

Fixed seat

Faux Leather back

Stain repellent (Seat only)

To specify, change the 10th digit from an **A** to **F** and deduct **\$20.40** list; **Example:** SFS-U0-7502F5

To specify, change the fifth digit in the product number to **U**; **Example:** SFS-UU-7502A5 (Wellington; add **\$117.30** list, Brisa; add **\$302.94** list)

To specify, add **P** to the end of the product number and add **\$35.70** list; **Example:** SFS-U0-7502A5P

Fern

Task Stool with 4D Arms — Aluminum Model



SFS-U0-7S02A

Dimensions

- *SH: 21.75"-29.25"
(552mm-743mm)
- H: 46.75"-54.75"
(1187mm-1391mm)
- D: 28.5"(724mm)
- W: 29"(737mm)
- *SW: 19.9"(505mm)
- *AH: 6.7"-11.5"
(170mm-292mm)
- *SD: 15.5"-18.5"
(394mm-470mm)

* All measurements taken with the BIFMA chair measuring device.

Features

- Back: Flexible back with built in fronds wrapped in lofted mesh or faux leather.
- Seat: Flexible seat pan with standard upholstered foam.
- Standard fixed seat. Optional seat depth adjustment (3"(76mm) range).
- Optional height adjustable lumbar support (4"(102mm) adjustment).
- Arms: 4D arms with aluminum upright.
 - Move fore, aft, side to side and pivot in and out.
 - Height adjustment range of 4.8"(122mm).
- Arm Caps: Standard with soft arm caps.
- Mechanism: Synchronized 3-point tilt; standard tilt tension adjustment.
- Height Adjustment: Pneumatic. Range: 21.75"-29.25"(552mm-743mm).
- Optional Back Stop: 4 positions.
- Base: Aluminum five-star base.
- Footring: Adjusts 4"(102mm) up and down. Brushed aluminum finish.
- Casters: Hard casters in black or two-tone grey; Soft casters black only.
- COM yardage / COL square footage: (Seat only) 0.71/8

To Order, Specify:

- 1) Product number, including;

1 Caster Option:

- 1** Hard Casters (Black)
- 2** Soft Casters (Black)
- T** Hard Two-Tone Casters (Grey)

- 2) Fabric surface and color (seat).
- 3) Mesh or faux leather color (back).
- 4) Plastic trim color for back frame/cradle/arm caps/levers. (Add **\$56.10** list for Snow TR-UFM for back frame/cradle.)
- 5) Aluminum trim color for back and arm upright/mechanism/base. (Add **\$91.80** list for polished aluminum back upright and mechanism.)

1st Trim Color (Plastic)	Arm Cap/Levers	Lumbar Handle
TR-F Black	TR-F Black	TR-TF Pitch
TR-7 Fog	TR-7 Fog	TR-AR Argent
TR-UFM Snow	TR-7 Fog	TR-FS Snowfall
TR-UFM Snow w/2nd trim PM-P Polished Aluminum	TR-7 Fog	PM-P Polished Aluminum

Specification Tip

- When Polished Aluminum trim is specified, lumbar handle will default to Polished Aluminum.

Description	Number	①	Fabric Grade								Leather Grade A	Leather Grade B
			A	B	C	D	E	F	G	H		
Mesh Back, No Lumbar Adjustment												
Pneumatic w/Seat Depth Adjustment	SFS-U0-7S02A		\$1727.88	\$1762.56	\$1799.28	\$1817.64	\$1830.90	\$1863.54	\$1894.14	\$1974.72	\$2031.84	\$2176.68
Back Stop w/Seat Depth Adjustment	SFS-U0-7S01A		1809.48	1844.16	1880.88	1899.24	1912.50	1945.14	1975.74	2056.32	2113.44	2258.28
Mesh Back, Lumbar Adjustment												
Pneumatic w/Seat Depth Adjustment	SFS-U0-7S12A		\$1819.68	\$1854.36	\$1891.08	\$1909.44	\$1922.70	\$1955.34	\$1985.94	\$2066.52	\$2123.64	\$2268.48
Back Stop w/Seat Depth Adjustment	SFS-U0-7S11A		1901.28	1935.96	1972.68	1991.04	2004.30	2036.94	2067.54	2148.12	2205.24	2350.08

The following options require modification of the product number.

- Fixed seat To specify, change the 10th digit from an **A** to **F** and deduct **\$20.40** list; **Example:** SFS-U0-7S02F1
- Faux Leather back To specify, change the fifth digit in the product number to **U**; **Example:** SFS-UU-7S02A1 (Wellington; add **\$117.30** list, Brisa; add **\$302.94** list)
- Stain repellent (Seat only) To specify, add **P** to the end of the product number and add **\$35.70** list; **Example:** SFS-U0-7S02A1P

Fern

Task Stool with Height Adjustable Arms — Plastic Model



SFS-U0-4S02A

1st Trim Color (Plastic)	Arm Cap/Levers	Lumbar Handle
TR-F Black	TR-F Black	TR-TF Pitch
TR-7 Fog	TR-7 Fog	TR-AR Argent

Dimensions

- *SH: 21.75"-29.25"
(552mm-743mm)
- H: 46.75"-54.75"
(1187mm-1391mm)
- D: 28.5"(724mm)
- W: 29"(737mm)
- *SW: 19.9"(505mm)
- *AH: 6.7"-11.5"
(170mm-292mm)
- *SD: 15.5"-18.5"
(394mm-470mm)

* All measurements taken with the BIFMA chair measuring device.

Features

- Back: Flexible back with built in fronds wrapped in lofted mesh or faux leather.
- Seat: Flexible seat pan with standard upholstered foam.
- Standard fixed seat. Optional seat depth adjustment (3"(76mm) range).
- Base: Plastic five-star base.
- Optional height adjustable lumbar support (4"(102mm) adjustment).
- Arms: Height Adjustable with soft arm caps. Adjustment range of 4.8"(122mm).
- Mechanism: Synchronized 3-point tilt; standard tilt tension adjustment.
- Height Adjustment: Pneumatic. Range: 21.75"-29.25"(552mm-743mm).
- Optional Back Stop: 4 positions.
- Footring: Adjusts 4"(102mm) up and down. Brushed aluminum finish.
- Casters: Hard casters in black or two-tone grey; Soft casters black only.
- COM yardage / COL square footage: (Seat only) 0.71/8

To Order, Specify:

- 1) Product number, including;
 - 1** **Caster Option:**
 - 5** Hard Casters (Black)
 - 6** Soft Casters (Black)
 - 7** Hard Two-Tone Casters (Grey)
- 2) Fabric surface and color (seat).
- 3) Mesh or faux leather color (back).
- 4) Plastic trim color for back frame/cradle/arm uprights/arm caps/levers/base.
- 5) Aluminum trim color for back upright and mechanism.
(Add **\$91.80** list for polished aluminum back upright and mechanism.)

Specification Tip

- When Polished Aluminum trim is specified, lumbar handle will default to Polished Aluminum.

Description	Number	①	Fabric Grade							Leather Grade A	Leather Grade B	
			A	B	C	D	E	F	G			H
Mesh Back, No Lumbar Adjustment												
Pneumatic w/Seat Depth Adjustment	SFS-U0-4S02A		\$1547.34	\$1582.02	\$1618.74	\$1637.10	\$1650.36	\$1683.00	\$1713.60	\$1794.18	\$1851.30	\$1996.14
Back Stop w/Seat Depth Adjustment	SFS-U0-4S01A		1628.94	1663.62	1700.34	1718.70	1731.96	1764.60	1795.20	1875.78	1932.90	2077.74
Mesh Back, Lumbar Adjustment												
Pneumatic w/Seat Depth Adjustment	SFS-U0-4S12A		\$1639.14	\$1673.82	\$1710.54	\$1728.90	\$1742.16	\$1774.80	\$1805.40	\$1885.98	\$1943.10	\$2087.94
Back Stop w/Seat Depth Adjustment	SFS-U0-4S11A		1720.74	1755.42	1792.14	1810.50	1823.76	1856.40	1887.00	1967.58	2024.70	2169.54

The following options require modification of the product number.

- | | |
|-----------------------------|--|
| Fixed seat | To specify, change the 10th digit from an A to F and deduct \$20.40 list; Example: SFS-U0-4S02F5 |
| Faux Leather back | To specify, change the fifth digit in the product number to U ; Example: SFS-UU-4S02A5 (Wellington; add \$117.30 list, Brisa; add \$302.94 list) |
| Stain repellent (Seat only) | To specify, add P to the end of the product number and add \$35.70 list; Example: SFS-U0-4S02A5P |

Fern

Task Stool with Height Adjustable Arms — Aluminum Model



SFS-U0-4S02A

Dimensions

- *SH: 21.75"-29.25"
(552mm-743mm)
- H: 46.75"-54.75"
(1187mm-1391mm)
- D: 28.5"(724mm)
- W: 29"(737mm)
- *SW: 19.9"(505mm)
- *AH: 6.7"-11.5"
(170mm-292mm)
- *SD: 15.5"-18.5"
(394mm-470mm)

* All measurements taken with the BIFMA chair measuring device.

Features

- Back: Flexible back with built in fronds wrapped in lofted mesh or faux leather.
- Seat: Flexible seat pan with standard upholstered foam.
- Standard fixed seat. Optional seat depth adjustment (3"(76mm) range).
- Optional height adjustable lumbar support (4"(102mm) adjustment).
- Arms: Height Adjustable with soft arm caps. Adjustment range of 4.8"(122mm).
- Mechanism: Synchronized 3-point tilt; standard tilt tension adjustment.
- Height Adjustment: Pneumatic. Range: 21.75"-29.25"(552mm-743mm).
- Optional Back Stop: 4 positions.
- Base: Aluminum five-star base.
- Footring: Adjusts 4"(102mm) up and down. Brushed aluminum finish.
- Casters: Hard casters in black or two-tone grey; Soft casters black only.
- COM yardage / COL square footage: (Seat only) 0.71/8

To Order, Specify:

1) Product number, including;

1 Caster Option:

- 1** Hard Casters (Black)
- 2** Soft Casters (Black)
- T** Hard Two-Tone Casters (Grey)

2) Fabric surface and color (seat).

3) Mesh or faux leather color (back).

4) Plastic trim color for back frame/cradle/arm caps/levers. (Add **\$56.10** list for Snow TR-UFM for back frame/cradle.)

5) Aluminum trim color for back and arm upright/mechanism/base. (Add **\$91.80** list for polished aluminum back upright and mechanism.)

1st Trim Color (Plastic)	Arm Cap/Levers	Lumbar Handle
TR-F Black	TR-F Black	TR-TF Pitch
TR-7 Fog	TR-7 Fog	TR-AR Argent
TR-UFM Snow	TR-7 Fog	TR-FS Snowfall
TR-UFM Snow w/2nd trim PM-P Polished Aluminum	TR-7 Fog	PM-P Polished Aluminum

Specification Tip

- When Polished Aluminum trim is specified, lumbar handle will default to Polished Aluminum.

Description	Number	1	Fabric Grade								Leather Grade A	Leather Grade B
			A	B	C	D	E	F	G	H		
Mesh Back, No Lumbar Adjustment												
Pneumatic w/Seat Depth Adjustment	SFS-U0-4S02A		\$1702.38	\$1737.06	\$1773.78	\$1792.14	\$1805.40	\$1838.04	\$1868.64	\$1949.22	\$2006.34	\$2151.18
Back Stop w/Seat Depth Adjustment	SFS-U0-4S01A		1783.98	1818.66	1855.38	1873.74	1887.00	1919.64	1950.24	2030.82	2087.94	2232.78
Mesh Back, Lumbar Adjustment												
Pneumatic w/Seat Depth Adjustment	SFS-U0-4S12A		\$1794.18	\$1828.86	\$1865.58	\$1883.94	\$1897.20	\$1929.84	\$1960.44	\$2041.02	\$2098.14	\$2242.98
Back Stop w/Seat Depth Adjustment	SFS-U0-4S11A		1875.78	1910.46	1947.18	1965.54	1978.80	2011.44	2042.04	2122.62	2179.74	2324.58

The following options require modification of the product number.

Fixed seat

To specify, change the 10th digit from an **A** to **F** and deduct **\$20.40** list; **Example:** SFS-U0-4S02F1

Faux Leather back

To specify, change the fifth digit in the product number to **U**; **Example:** SFS-UU-4S02A1 (Wellington; add **\$117.30** list, Brisa; add **\$302.94** list)

Stain repellent (Seat only)

To specify, add **P** to the end of the product number and add **\$35.70** list; **Example:** SFS-U0-4S02A1P

Fern

Task Stool with Fixed Arms — Plastic Model



SFS-U0-1S02A

Dimensions

- *SH: 21.75"-29.25"
(552mm-743mm)
- H: 46.75"-54.75"
(1187mm-1391mm)
- D: 28.5"(724mm)
- W: 29"(737mm)
- *SW: 19.9"(505mm)
- *AH: 9"(229mm)
- *SD: 15.5"-18.5"
(394mm-470mm)

* All measurements taken with the BIFMA chair measuring device.

Features

- Back: Flexible back with built in fronds wrapped in lofted mesh or faux leather.
- Seat: Flexible seat pan with standard upholstered foam.
- Standard fixed seat. Optional seat depth adjustment (3"(76mm) range).
- Optional height adjustable lumbar support (4"(102mm) adjustment).
- Arms: Fixed aluminum arms with soft arm caps.
- Optional leather arm cap available when ordering a leather seat. Leather arm cap coordinates with leather seat selection.
- Mechanism: Synchronized 3-point tilt; standard tilt tension adjustment.
- Height Adjustment: Pneumatic. Range: 21.75"-29.25"(552mm-743mm).
- Optional Back Stop: 4 positions.
- Base: Plastic five-star base.
- Footring: Adjusts 4"(102mm) up and down. Brushed aluminum finish.
- Casters: Hard casters in black or two-tone grey; Soft casters black only.
- COM yardage / COL square footage: (Seat only) 0.71/8

To Order, Specify:

- 1) Product number, including;
 - 1** **Caster Option:**
 - 5** Hard Casters (Black)
 - 6** Soft Casters (Black)
 - 7** Hard Two-Tone Casters (Grey)
- 2) Fabric surface and color (seat).
- 3) Mesh or faux leather color (back).
- 4) Plastic trim color for back frame/cradle/arm caps/levers/base.
- 5) Aluminum trim color for back and arm upright/mechanism. (Add \$91.80 list for polished aluminum back upright and mechanism.)

1st Trim Color (Plastic)	Arm Cap/Levers	Lumbar Handle
TR-F Black	TR-F Black	TR-TF Pitch
TR-7 Fog	TR-7 Fog	TR-AR Argent

Specification Tip

- When Polished Aluminum trim is specified, lumbar handle will default to Polished Aluminum.

Description	Number	Fabric Grade								Leather Grade A	Leather Grade B
		1 A	B	C	D	E	F	G	H		
Mesh Back, No Lumbar Adjustment											
Pneumatic w/Seat Depth Adjustment	SFS-U0-1S02A	\$1532.04	\$1566.72	\$1603.44	\$1621.80	\$1635.06	\$1667.70	\$1698.30	\$1778.88	\$1836.00	\$1980.84
Back Stop w/Seat Depth Adjustment	SFS-U0-1S01A	1613.64	1648.32	1685.04	1703.40	1716.66	1749.30	1779.90	1860.48	1917.60	2062.44
Mesh Back, Lumbar Adjustment											
Pneumatic w/Seat Depth Adjustment	SFS-U0-1S12A	\$1623.84	\$1658.52	\$1695.24	\$1713.60	\$1726.86	\$1759.50	\$1790.10	\$1870.68	\$1927.80	\$2072.64
Back Stop w/Seat Depth Adjustment	SFS-U0-1S11A	1705.44	1740.12	1776.84	1795.20	1808.46	1841.10	1871.70	1952.28	2009.40	2154.24

The following options require modification of the product number.

- | | |
|-----------------------------|---|
| Fixed seat | To specify, change the 10th digit from an A to F and deduct \$20.40 list; Example: SFS-U0-1S02 F 5 |
| Leather arm cap | To specify, change the 7th digit from S to L ; Example: SFS-U0-1 L 02A5 (matches required Leather seat), add \$71.40 list |
| Faux Leather back | To specify, change the fifth digit in the product number to U ; Example: SFS- UU -1S02A5 (Wellington; add \$117.30 list, Brisa; add \$302.94 list) |
| Stain repellent (Seat only) | To specify, add P to the end of the product number and add \$35.70 list; Example: SFS-U0-1S02A5 P |

Fern

Task Stool with Fixed Arms — Aluminum Model



SFS-U0-1S02A

Dimensions

- *SH: 21.75"-29.25"
(552mm-743mm)
- H: 46.75"-54.75"
(1187mm-1391mm)
- D: 28.5"(724mm)
- W: 29"(737mm)
- *SW: 19.9"(505mm)
- *AH: 9"(229mm)
- *SD: 15.5"-18.5"
(394mm-470mm)

* All measurements taken with the BIFMA chair measuring device.

Features

- Back: Flexible back with built in fronds wrapped in lofted mesh or faux leather.
- Seat: Flexible seat pan with standard upholstered foam.
- Standard fixed seat. Optional seat depth adjustment (3"(76mm) range).
- Optional height adjustable lumbar support (4"(102mm) adjustment).
- Arms: Fixed with soft arm caps.
- Optional leather arm cap available when ordering a leather seat. Leather arm cap coordinates with leather seat selection.
- Mechanism: Synchronized 3-point tilt; standard tilt tension adjustment.
- Height Adjustment: Pneumatic. Range: 21.75"-29.25"(552mm-743mm).
- Optional Back Stop: 4 positions.
- Base: Aluminum five-star base.
- Footring: Adjusts 4"(102mm) up and down. Brushed aluminum finish.
- Casters: Hard casters in black or two-tone grey; Soft casters black only.
- COM yardage / COL square footage: (Seat only) 0.71/8

To Order, Specify:

- 1) Product number, including;

1 Caster Option:

- 1** Hard Casters (Black)
- 2** Soft Casters (Black)
- T** Hard Two-Tone Casters (Grey)

- 2) Fabric surface and color (seat).
- 3) Mesh or faux leather color (back).
- 4) Plastic trim color for base frame/cradle/arm caps/levers. (Add **\$56.10** list for Snow TR-UFM for back frame/cradle.)
- 5) Aluminum trim color for back and arm upright/mechanism/base. (Add **\$91.80** list for polished aluminum back upright and mechanism.)

1st Trim Color (Plastic)	Arm Cap/Levers	Lumbar Handle
TR-F Black	TR-F Black	TR-TF Pitch
TR-7 Fog	TR-7 Fog	TR-AR Argent
TR-UFM Snow	TR-7 Fog	TR-FS Snowfall
TR-UFM Snow w/2nd trim PM-P Polished Aluminum	TR-7 Fog	PM-P Polished Aluminum

Specification Tip

- When Polished Aluminum trim is specified, lumbar handle will default to Polished Aluminum.

Description	Number	①	Fabric Grade							Leather Grade A	Leather Grade B	
			A	B	C	D	E	F	G			H
Mesh Back, No Lumbar Adjustment												
Pneumatic w/Seat Depth Adjustment	SFS-U0-1S02A		\$1687.08	\$1721.76	\$1758.48	\$1776.84	\$1790.10	\$1822.74	\$1853.34	\$1933.92	\$1991.04	\$2135.88
Back Stop w/Seat Depth Adjustment	SFS-U0-1S01A		1768.68	1803.36	1840.08	1858.44	1871.70	1904.34	1934.94	2015.52	2072.64	2217.48
Mesh Back, Lumbar Adjustment												
Pneumatic w/Seat Depth Adjustment	SFS-U0-1S12A		\$1778.88	\$1813.56	\$1850.28	\$1868.64	\$1881.90	\$1914.54	\$1945.14	\$2025.72	\$2082.84	\$2227.68
Back Stop w/Seat Depth Adjustment	SFS-U0-1S11A		1860.48	1895.16	1931.88	1950.24	1963.50	1996.14	2026.74	2107.32	2164.44	2309.28

The following options require modification of the product number.

- Fixed seat To specify, change the 10th digit from an **A** to **F** and deduct **\$20.40** list; **Example:** SFS-U0-1S02F1
- Leather arm cap To specify, change the 7th digit from **S** to **L**; **Example:** SFS-U0-1L02A1 (matches required Leather seat), add **\$71.40** list
- Faux Leather back To specify, change the fifth digit in the product number to **U**; **Example:** SFS-UU-1S02A1 (Wellington; add **\$117.30** list, Brisa; add **\$302.94** list)
- Stain repellent (Seat only) To specify, add **P** to the end of the product number and add **\$35.70** list; **Example:** SFS-U0-1S02A1P

Fern

Task Stool without Arms — Plastic Model



SFS-U0-0N02A

Dimensions

- *SH: 21.75"-29.25"
(552mm-743mm)
- H: 46.75"-54.75"
(1187mm-1391mm)
- D: 28.5"(724mm)
- W: 29"(737mm)
- *SW: 19.9"(505mm)
- *SD: 15.5"-18.5"
(394mm-470mm)

* All measurements taken with the BIFMA chair measuring device.

Features

- Back: Flexible back with built in fronds wrapped in lofted mesh or faux leather.
- Seat: Flexible seat pan with standard upholstered foam.
- Standard fixed seat. Optional seat depth adjustment (3"(76mm) range).
- Optional height adjustable lumbar support (4"(102mm) adjustment).
- Mechanism: Synchronized 3-point tilt; standard tilt tension adjustment.
- Height Adjustment: Pneumatic. Range: 21.75"-29.25"(552mm-743mm).
- Optional Back Stop: 4 positions.
- Footring: Adjusts 4"(102mm) up and down. Brushed aluminum finish.
- Casters: Hard casters in black or two-tone grey; Soft casters black only.
- COM yardage / COL square footage: (Seat only) 0.71/8

To Order, Specify:

- 1) Product number, including;
 - 1** **Caster Option:**
 - 5** Hard Casters (Black)
 - 6** Soft Casters (Black)
 - 7** Hard Two-Tone Casters (Grey)
- 2) Fabric surface and color (seat).
- 3) Mesh or faux leather color (back).
- 4) Plastic trim color for back frame/cradle/ levers/base.
- 5) Aluminum trim color for back upright and mechanism. (Add **\$91.80** list for polished aluminum back upright and mechanism.)

1st Trim Color (Plastic)	Levers	Lumbar Handle
TR-F Black	TR-F Black	TR-TF Pitch
TR-7 Fog	TR-7 Fog	TR-AR Argent

Specification Tip

- When Polished Aluminum trim is specified, lumbar handle will default to Polished Aluminum.

Description	Number	①	Fabric Grade								Leather Grade A	Leather Grade B
			A	B	C	D	E	F	G	H		
Mesh Back, No Lumbar Adjustment												
Pneumatic w/Seat Depth Adjustment	SFS-U0-0N02A		\$1409.64	\$1444.32	\$1481.04	\$1499.40	\$1512.66	\$1545.30	\$1575.90	\$1656.48	\$1713.60	\$1858.44
Back Stop w/Seat Depth Adjustment	SFS-U0-0N01A		1491.24	1525.92	1562.64	1581.00	1594.26	1626.90	1657.50	1738.08	1795.20	1940.04
Mesh Back, Lumbar Adjustment												
Pneumatic w/Seat Depth Adjustment	SFS-U0-0N12A		\$1501.44	\$1536.12	\$1572.84	\$1591.20	\$1604.46	\$1637.10	\$1667.70	\$1748.28	\$1805.40	\$1950.24
Back Stop w/Seat Depth Adjustment	SFS-U0-0N11A		1583.04	1617.72	1654.44	1672.80	1686.06	1718.70	1749.30	1829.88	1887.00	2031.84

The following options require modification of the product number.

- Fixed seat To specify, change the 10th digit from an **A** to **F** and deduct **\$20.40** list; **Example:** SFS-U0-0N02F5
- Faux Leather back To specify, change the fifth digit in the product number to **U**; **Example:** SFS-UU-0N02A5 (Wellington; add **\$117.30** list, Brisa; add **\$302.94** list)
- Stain repellent (Seat only) To specify, add **P** to the end of the product number and add **\$35.70** list; **Example:** SFS-U0-0N02A5P

Fern

Task Stool without Arms — Aluminum Model



SFS-U0-0N02A

Dimensions

- *SH: 21.75"-29.25"
(552mm-743mm)
- H: 46.75"-54.75"
(1187mm-1391mm)
- D: 28.5"(724mm)
- W: 29"(737mm)
- *SW: 19.9"(505mm)
- *SD: 15.5"-18.5"
(394mm-470mm)

* All measurements taken with the BIFMA chair measuring device.

Features

- Back: Flexible back with built in fronds wrapped in lofted mesh or faux leather.
- Seat: Flexible seat pan with standard upholstered foam.
- Standard fixed seat. Optional seat depth adjustment (3"(76mm) range).
- Optional height adjustable lumbar support (4"(102mm) adjustment).
- Mechanism: Synchronized 3-point tilt; standard tilt tension adjustment.
- Height Adjustment: Pneumatic. Range: 21.75"-29.25"(552mm-743mm).
- Optional Back Stop: 4 positions.
- Base: Aluminum five-star base.
- Footring: Adjusts 4"(102mm) up and down. Brushed aluminum finish.
- Casters: Hard casters in black or two-tone grey; Soft casters black only.
- COM yardage / COL square footage: (Seat only) 0.71/8

To Order, Specify:

1) Product number, including;

1) Caster Option:

- 1** Hard Casters (Black)
- 2** Soft Casters (Black)
- T** Hard Two-Tone Casters (Grey)

2) Fabric surface and color (seat).

3) Mesh or faux leather color (back).

4) Plastic trim color for back frame/cradle/levers. (Add **\$56.10** list for Snow TR-UFM for back frame/cradle.)

5) Aluminum trim color for back upright/mechanism/base. (Add **\$91.80** list for polished aluminum back upright and mechanism.)

1st Trim Color (Plastic)	Levers	Lumbar Handle
TR-F Black	TR-F Black	TR-TF Pitch
TR-7 Fog	TR-7 Fog	TR-AR Argent
TR-UFM Snow	TR-7 Fog	TR-FS Snowfall
TR-UFM Snow w/2nd trim PM-P Polished Aluminum	TR-7 Fog	PM-P Polished Aluminum

Specification Tip

- When Polished Aluminum trim is specified, lumbar handle will default to Polished Aluminum.

Description	Number	1	Fabric Grade								Leather Grade A	Leather Grade B
			A	B	C	D	E	F	G	H		
Mesh Back, No Lumbar Adjustment												
Pneumatic w/Seat Depth Adjustment	SFS-U0-0N02A		\$1564.68	\$1599.36	\$1636.08	\$1654.44	\$1667.70	\$1700.34	\$1730.94	\$1811.52	\$1868.64	\$2013.48
Back Stop w/Seat Depth Adjustment	SFS-U0-0N01A		1646.28	1680.96	1717.68	1736.04	1749.30	1781.94	1812.54	1893.12	1950.24	2095.08
Mesh Back, Lumbar Adjustment												
Pneumatic w/Seat Depth Adjustment	SFS-U0-0N12A		\$1656.48	\$1691.16	\$1727.88	\$1746.24	\$1759.50	\$1792.14	\$1822.74	\$1903.32	\$1960.44	\$2105.28
Back Stop w/Seat Depth Adjustment	SFS-U0-0N11A		1738.08	1772.76	1809.48	1827.84	1841.10	1873.74	1904.34	1984.92	2042.04	2186.88

The following options require modification of the product number.

- Fixed seat To specify, change the 10th digit from an **A** to **F** and deduct **\$20.40** list; **Example:** SFS-U0-0N02F1
- Faux Leather back To specify, change the fifth digit in the product number to **U**; **Example:** SFS-UU-0N02A1 (Wellington; add **\$117.30** list, Brisa; add **\$302.94** list)
- Stain repellent (Seat only) To specify, add **P** to the end of the product number and add **\$35.70** list; **Example:** SFS-U0-0N02A1P

Zody-At-A-Glance

Designer	ITO Design and Haworth Design Studio
Awards/Achievements	NeoCon Silver, Best of NeoCon, Seating: Ergonomic Desk/Task, June 2005, USA IIDEX/NeoCon Gold, Seating: Desk/Workstation Chairs, September 2005, Canada BIFMA level 3 certified.
Zody	A high-performing chair that blends science-based wellness and comfort with sustainability and international design.

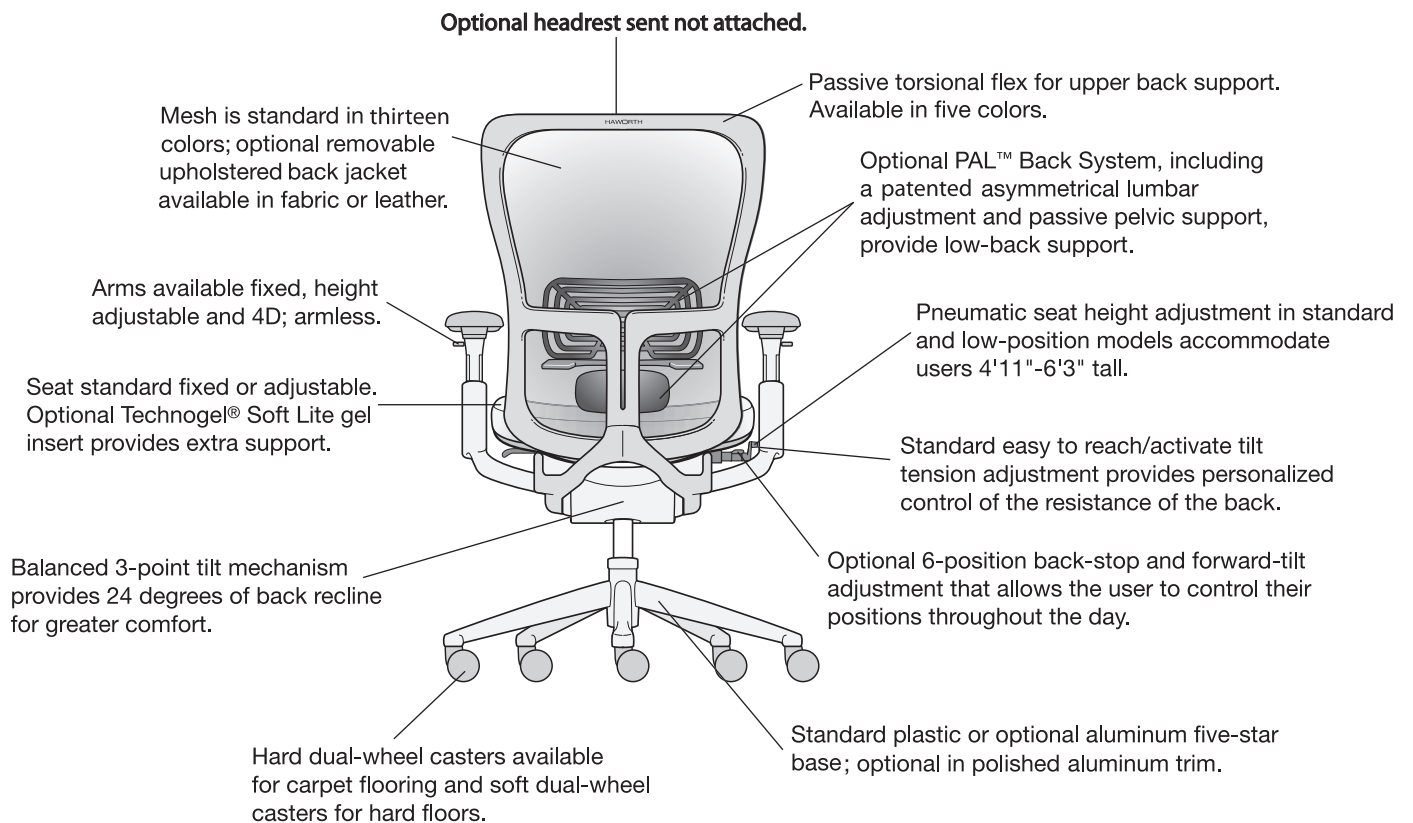

Note: Headrest and forward-tilt options not available on Stool.

Zody-At-A-Glance

General Specifications

General Guidelines for Product Specification

Zody seating specification numbers are based on an alpha-numeric logic that identifies a product by model and certain characteristics.

For example, a product number that reads **SZT-20-702MA5** identifies the product as a Zody mesh back chair with 4D arms, no lumbar, pneumatic seat height adjustment, foam adjustable seat and standard plastic base TR-F black only with hard casters. The numeric logic for this model with fabric and finish codes is shown below:

Mesh Back

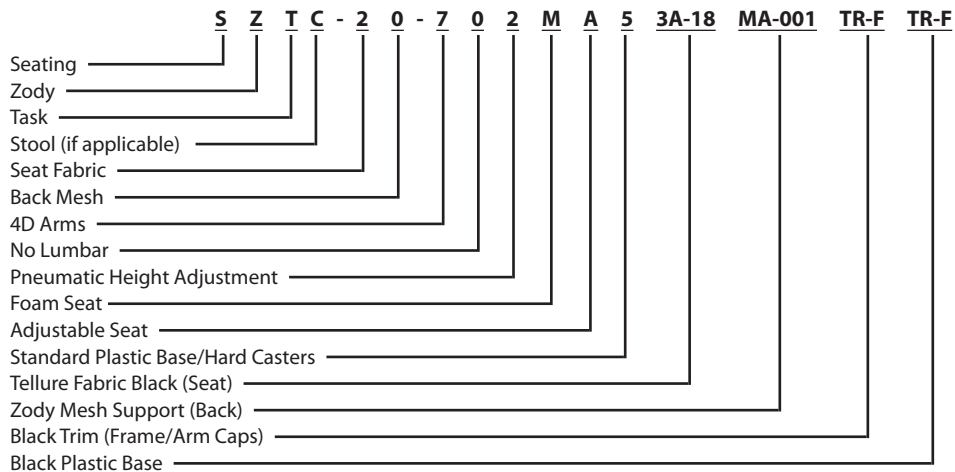

Mesh Back with Upholstered Back Jacket

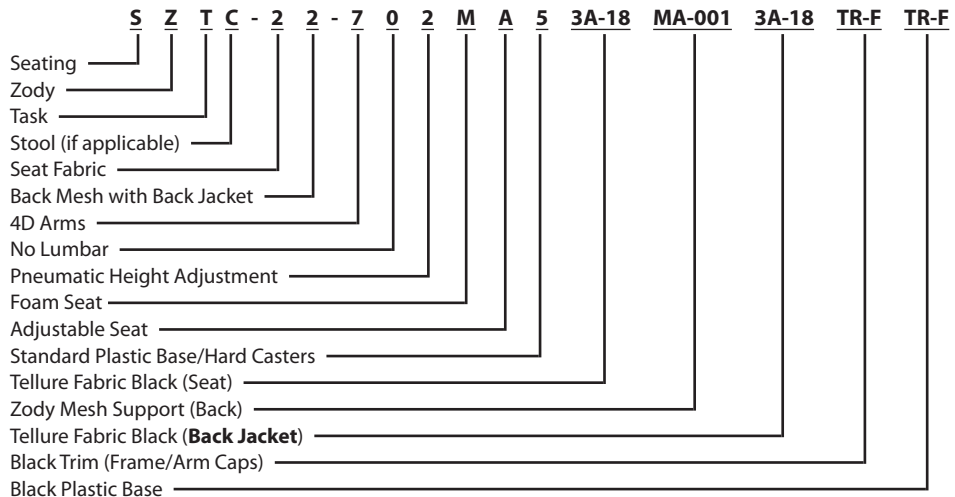

There are exceptions to this logic; therefore, always refer to the price charts for product numbers rather than attempting to construct them. Product number modification instructions for additional options appear in footnoted copy for each applicable model.

Beyond the printed product number, fabric and finish codes are required to complete an order specification. To communicate your order clearly, list the product number and fabric/finish codes in the sequence outlined on each price page.

Zody-At-A-Glance

General Specifications

Environmental Factors	<ul style="list-style-type: none"> • Zody has been evaluated for its human health, environmental health, lifecycle attributes, renewable energy, water stewardship and social responsibility characteristics against stringent certification criteria and is considered an ecologically intelligent product. • Greenguard Children and Schools certified for low emissions. • BIFMA level 3 certified 2012. • Zody has up to 51% recycled content and is up to 98% recyclable. • Zody is produced in an ISO 14001 certified manufacturing facility. • Zody is assembled using renewable power. Haworth has purchased 100% Green-e certified American wind power credits to offset the energy consumed in manufacturing the product. • Components are identified with ISO recycling symbols and material information to assist in the recycling effort, where practical. • Haworth will take back Zody chairs after their useful life and recycle the components. Please contact Haworth's Material Recovery Center at (616)393-1215. • Optional Trivalent chrome finish provides safer and more environmentally friendly alternative for customers requiring the attributes of a chrome finish.
COM & COL General Information	<p>To order a COM fabric (Customer's Own Material), contact the Haworth Inquiry Center (1.800.426.8562), your local Haworth dealer, or go to surfaces.haworth.com > COM Library to find out if the COM you have selected has already been tested and approved. The surface collection site also has information on the Haworth+ alliance program with Carnegie, Luna Textiles, and Maharam as well as our industry-leading Pre-Approved COM program.</p> <p>COM fabrics are placed into Grades based on the cost per linear yard. If a fabric's cost exceeds the range of our highest Grade it will be noted as Non-Graded. The product will be priced at Grade A; the COM fabric costs will appear as a separate line item. The fabric charge will be Haworth's purchase cost plus a 4% administrative fee (based on the cost of the fabric). Yardage calculations will include any applicable fabric repeat.</p> <p>COM Leather products will be priced at a leather Grade A; COL costs will appear as a separate line item. The leather costs will be Haworth's purchase cost plus a 4% administrative fee (based on the cost of the leather).</p>
Finishes and Fabrics	A complete listing of finishes and fabrics for Zody seating is available in the back of the price list.
Shipping Weights (Including packaging)	<ul style="list-style-type: none"> • Chairs with arms: 55 pounds/1 chair per carton/17.3 cubic feet • Chairs without arms: 51 pounds/1 chair per carton/17.3 cubic feet • Chairs with sled base: 24 pounds/1 chair per carton/17.3 cubic feet • Chairs with leg base: 21 pounds/1 chair per carton/17.3 cubic feet • Stool with arms: 58 pounds/1 stool per carton/21.5 cubic feet • Stool without arms: 54 pounds/1 stool per carton/21.5 cubic feet
Stain Repellent	<p>To specify add "P" to end of product number. Example: SZT-22-702MA1P</p> <p>Not available on mesh, faux leather, or leather. For available fabrics, refer to surfaces.haworth.com.</p>

Zody

General Specifications

STANDARD MOBILITY AND ADJUSTABILITY

Balanced 3-point tilt

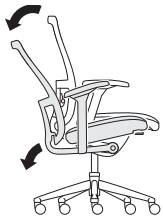

Features:

- Balanced 3-point tilt mechanism.
- Back reclines 24° from the upright position.
- Seat pan moves downward 3° from the initial position.

Benefits:

- Comfortable relaxed posture.
- Recline allows for the opening of the users' chest cavity providing good airflow to promote alertness.
- Users' feet remain flat.

Tilt Tension Control

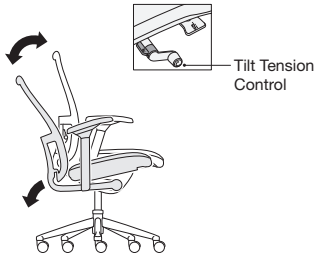

Feature:

- Easy-to-reach and easy-to-activate side-mounted tilt tension control regulates the amount of resistance felt when leaning back in the chair and the effort required to recline the chair backwards.

Benefit:

- Personalized support to accommodate users of different body types and different work styles.

Seat Height Adjustment

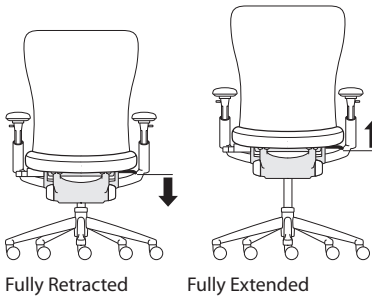

Features:

- Pneumatic seat height adjustment.
- Task chair seat height adjusts 5"(127mm) from 16" to 21"(406mm to 533mm) in standard models. Low-position adjusts 14" to 17"(356 to 432mm).
- Task stool seat height adjusts 7.5"(191mm) from 21.5" to 29"(546mm to 737mm).

Benefits:

- Ensures the comfort of the lower limbs by avoiding pressure on the underside of the thigh caused by a seat pan that is too high, or decreased thigh-to-torso angle if the seat pan is too low.
- Accommodates for users between approximately 4'11"(1499mm) and 6'3"(1905mm) tall to provide good leg circulation.
- Seat height adjustment also is important in setting the proper hand position and allowing for a proper sitting eye height.

Seat Depth Adjustment

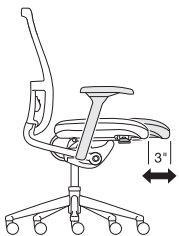

Features:

- 3"(76mm) of seat depth range. (Fixed seat also available.)
- Available with conventional foam material or optional Technogel® Soft Lite gel insert.
- Waterfall edge.

Benefit:

- Supports the thighs, allows users to rest against the seat back for back support, and avoids pressure on the back of the knees of small to tall users.

Upper Back Torsional Movement



Feature:

- Passive 2"(51mm) of torsional flex in the upper back.
- Patented mesh with built in tension zones for added comfort.

Benefit:

- Increases users' mobility and comfort when reaching sideways for objects.

Zody

General Specifications

OPTIONAL MOBILITY AND ADJUSTABILITY

PAL Back System**Features:**

- PAL Back System includes Asymmetrical Lumbar Adjustment and passive pelvic support.
- Asymmetrical Lumbar Adjustment adjusts 4"(102mm) in height; support level can be adjusted independently for right or left-hand side of users' body.
- Passive pelvic support.

Benefits:

- Lumbar adjustment maintains the natural curvature of the spine at the lower back and allows users to choose the support that feels right for them.
- Passive pelvic support rotates the pelvis forward to maintain the natural spine shape.

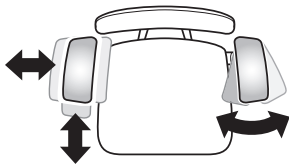
4D Arm**Features:**

- Optional 4D arm.
- Arm adjusts in 4 ways:
 - Height adjustment: 4"(102mm)
 - Side-to-side arm cap adjustment range: 3"(76mm) [1.5"(38mm) each arm cap]
 - Front-to-back adjustment range: 3 1/2"(89mm)
 - Pivoting: In 20°; out 20°

Benefits:

- Arms support the muscular system of users' neck and shoulders and proper arm support provides back relief. Arms can be an aid in standing or sitting down.
- Height adjustment accommodates for users with varying elbow rest heights so that users avoid lifting their shoulders or leaning sideways to get arm support.
- Front-to-back adjustment adjusts the armrest length, which is important because it allows users to get close to the worksurface while maintaining the effective use of the backrest.
- Side-to-side adjustment ensures a comfortable resting position for the arms with proper support of the forearm while allowing for easy entry/exit of the chair.
- Pivoting provides proper support of the forearm when performing tasks involving keying and mousing.

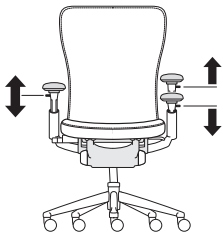
Adjustable Height Arm**Feature:**

- Optional height adjustable arms adjust 4"(102mm) vertically.

Benefit:

- Height adjustment accommodates users with varying elbow rest heights so that users avoid lifting their shoulders or leaning sideways to get arm support.

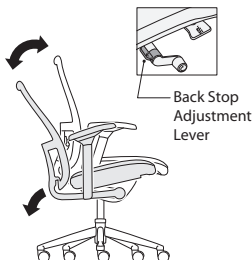
Tilt with Back Stop**Features:**

- Optional back stop;
- Back stops in 6 positions - upright and every 4° backward.
- Tilt limiter.

Benefit:

- Allows users the choice of selecting an upright position or limiting the amount of recline while performing different tasks.

Zody

General Specifications

OPTIONAL MOBILITY AND ADJUSTABILITY (continued)

Forward Tilt

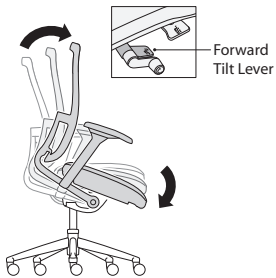

Features:

- Optional forward tilt.
- Seat pan moves downward 5° from the initial position.

Benefit:

- Allows the user the opportunity to vary their posture throughout the day.

Note: Not available on task stool.

Back Stop/Forward Tilt

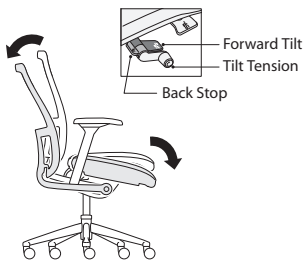

Feature:

- Optional back-stop and forward tilt.
- Back stops in 6 positions, upright and every 4° backward.

Benefit:

- Allows users to vary their posture for maximum comfort and for changes in task requirements.

Note: Not available on task stool.

Base

Standard Plastic Base

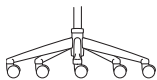

TR-F Black

Optional Aluminum Base

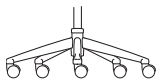

TR-F Black
 TR-LE Metallic Silver
 TR-MC Metallic Champagne
 TR-MG Metallic Gunmetal*
 TR-RR Rusty Red
 TR-1M Sable
 PM-P Polished Aluminum

Low Position Base (Aluminum only)

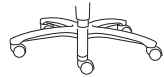

TR-F Black
 TR-LE Metallic Silver
 TR-MC Metallic Champagne
 TR-MG Metallic Gunmetal*

*Color on Alert status and being considered for future obsolescence due to low volume.

Note: Low Position Base not available on stool.

Ergonomic Standards Guidelines

- All Zody models meet or exceed all ANSI/BIFMA durability standards for office seating.
- Zody meets the following ergonomic standards/guidelines:
 - BSR/HFES 100-2002
 - BIFMA G1-2002
 - CSA-Z412-2000
 - CAN/CGSB 44.232-2002
 - HFES 2007

Zody

General Specifications
UPHOLSTERY / AESTHETIC OPTIONS

Leather Upholstery



Seat: Stitched double seams. Vertically in the center and on the edges of the seat cushion.

Back: Vertical stitched double seams on the upholstered back jacket with leather or Customers Own Leather (COL).

Upholstered Back Jacket

Front View:

Leather Jacket



Back View:



Features

- Removable.
- Back jacket covers the inside back of the chairs allowing a back view of the mesh. Jacket consists of padding covered with fabric or leather upholstery.
- Available in fabric, faux leather, leather, COM and COL.

Headrest



Features

- Height-adjustable 2.5" to fit a wide range of users, headrest is TPU material, like Zody arm.
 - Trim color of headrest front and back are in same color. Black or Smoke only. If a trim color other than Black or Smoke is specified, the headrest will default to Black or Smoke based on the matrix below.
 - Headrest sent not attached; 10.5"W x 7.5"H, 2.5" height adjustment.
 - See Zody price pages for specification (available on all task seating models). Not available on stools.
Specification Example: SZE-22-722MA1 (Zody with headrest, 4D arm).
- To add a headrest to an existing model in the field order service part: Back and Headrest replacement, see e-Parts.

Specification

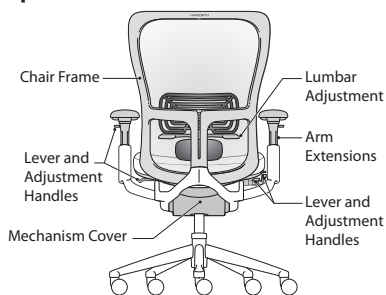

Features

- Trim color specification applies to the following components:
 - Chair frame
 - Levers
 - Adjustment handles
 - Lumbar adjustment (not lumbar pad)
 - Arm extensions
 - Mechanism covers
- Arm cap and Headrest color defaults based on the matrix below.

Trim Color	Arm Cap & Headrest Color*	
	Black	Smoke
Black (TR-F)	•	
Rusty Red (TR-RR)	•	
Sable (TR-1M)	•	
Smoke (TR-E)		•
Snow (TR-UFM)		•

*Not specifiable.

Zody Value Model

Task Chair with 4D Arms



SZT-20-711MA5

Dimensions*

- *SH: 16-21"
(406mm-533mm)
- H: 38-43"(965mm-1092mm)
- D: 29"(737mm)
- W: 29"(737mm)
- *SW: 19 1/4"(489mm)
- *AH: 6.8-10.8"
(173mm-274mm)
- *SD: 16-19"(406mm-483mm)

* All measurements taken with the BIFMA chair measuring device.

Features

- Back: Soft mesh only.
- Seat:
 - Upholstered with foam.
 - Adjustable [3"(76mm) range]
- Base: Plastic five-star.
- Arms: 4D with soft arm caps.
- Mechanism: Balanced 3-point tilt; tilt tension.
- Pneumatic height adjustment.
- Back Stop: Tilt stop in 6 positions
- Asymmetrical Lumbar Adjustment: 4"(102mm) height adjustment; support level can be adjusted independently for right- or left-hand side of users body.
- Casters: Hard Casters

To Order, Specify:

- 1) Product number.
 - 2) Seat surface/color:
3A-18 Tellure - Black
 - 3) Mesh Back:
MA-001 Black
 - 4) Trim color for frame/arm caps:
TR-F Black
 - 5) Trim color for base/arms:
TR-F Black
- Note:** No changes to specification. No COM or Specials.

Number	Price
SZT-20-711MA5	\$1213.80

Zody

Task Chair with 4D Arms



SZT-20-702MA1

Dimensions*

- *SH: 16-21"
(406mm-533mm)
- H: 38-43"(965mm-1092mm)
- D: 29"(737mm)
- W: 29"(737mm)
- *SW: 19 1/4"(489mm)
- *AH: 6.8-10.8"
(173mm-274mm)
- *SD: 16-19"(406mm-483mm)

Low position seat height:
14-17"(356mm-432mm)

* All measurements taken with the BIFMA chair measuring device.

Trim Color	Arm Cap & Headrest Color*	
	Black	Smoke
Black (TR-F)	•	
Rusty Red (TR-RR)	•	
Sable (TR-1M)	•	
Smoke (TR-E)		•
Snow (TR-UFM)		•

*Not specifiable.

Features

- Back: Soft mesh only or mesh back with upholstered back jacket.
- Seat: Standard upholstered with foam or optional foam with Technogel® Soft Lite gel insert.
- Seat Type: Standard adjustable [3"(76mm) range] or optional fixed.
- Base: Standard Plastic painted five-star base or optional painted aluminum or polished aluminum. –Plastic base available in Black. –Aluminum base available with painted Black, Rusty Red, Snow, Metallic Silver, Metallic Champagne, Metallic Gunmetal, or optional Polished Aluminum.
- Arms: 4D with soft arm caps. See matrix for default colors.
- Mechanism: Balanced 3-point tilt; standard tilt tension.
- Height adjustment: Pneumatic or low-position pneumatic.
- Optional Back Stop: Tilt stop in 6 positions.
- Optional Forward Tilt: 5 degrees downward from initial position.
- Optional Back Stop with Forward Tilt
- Optional Asymmetrical Lumbar Adjustment: 4"(102mm) height adjustment; support level can be adjusted independently for right or left hand side of users body. Optional PAL Back System: Passive pelvic support.
- Casters: Standard with hard casters; optional soft casters.
- COM yardage / COL square footage:
Mesh back model: .75/10
Mesh back/upholstered back jacket: 1.5/18

NOTE: When specifying fabric or leather back jacket; must also specify mesh surface color for outside back.

Upcharge for mixed grade surfaces, refer to the electronic design and specification tools.

To Order with Fabric or Leather Upholstered Back Jacket Specify:

1) Product number, including:

1 Base/Caster Option:

Aluminum Base

- 1 Aluminum Base, Hard Caster, add **\$32.78** to list
- 2 Aluminum Base, Soft Caster, add **\$32.78** to list
- 3 Aluminum Low Base, Hard Caster, add **\$32.78** to list
- 4 Aluminum Low Base, Soft Caster, add **\$32.78** to list

Plastic Base

- 5 Plastic Std. Base, Hard Caster
- 6 Plastic Std. Base, Soft Caster

- 2) Fabric surface and color (seat).
- 3) Mesh surface color (back).
- 4) Fabric surface and color (back jacket).
- 5) Trim color for frame. (Add **\$56.10** list for Snow.)
- 6) Trim color for base/arms. (Add **\$191.59** list for polished aluminum.)

To Order with Mesh Back Specify:

1) Product number, including:

1 Base/Caster Option:

Aluminum Base

- 1 Aluminum Base, Hard Caster, add **\$32.78** to list
- 2 Aluminum Base, Soft Caster, add **\$32.78** to list
- 3 Aluminum Low Base, Hard Caster, add **\$32.78** to list
- 4 Aluminum Low Base, Soft Caster, add **\$32.78** to list

Plastic Base

- 5 Plastic Std. Base, Hard Caster
- 6 Plastic Std. Base, Soft Caster

- 2) Fabric surface and color (seat).
- 3) Mesh surface and color (back).
- 4) Trim color for frame. (Add **\$56.10** list for Snow.)
- 5) Trim color for base/arms. (Add **\$191.59** list for polished aluminum.)

Zody

Task Chair with 4D Arms

Upholstered Foam Seat	Adjustments	Number	Fabric Grade								Leather Grade A	Leather Grade B
			A	B	C	D	E	F	G	H		
No Lumbar Adjustment - Mesh Back w/Plastic Base												
Pneumatic		SZT-20-702MA	\$1164.30	\$1198.71	\$1235.42	\$1253.79	\$1267.55	\$1300.83	\$1330.65	\$1412.11	\$1468.32	\$1617.74
Back Stop		SZT-20-701MA	1241.16	1275.57	1312.28	1330.65	1344.41	1377.69	1407.51	1488.97	1545.18	1694.60
Forward Tilt		SZT-20-703MA	1241.16	1275.57	1312.28	1330.65	1344.41	1377.69	1407.51	1488.97	1545.18	1694.60
Back Stop/ Forward Tilt		SZT-20-704MA	1265.26	1299.67	1336.38	1354.75	1368.51	1401.79	1431.61	1513.07	1569.28	1718.70
No Lumbar Adjustment - Upholstered Back Jacket w/Plastic Base												
Pneumatic		SZT-22-702MA	\$1277.88	\$1346.70	\$1420.12	\$1456.86	\$1484.38	\$1550.94	\$1610.58	\$1773.50	\$1885.92	\$2184.76
Back Stop		SZT-22-701MA	1354.74	1423.56	1496.98	1533.72	1561.24	1627.80	1687.44	1850.36	1962.78	2261.62
Forward Tilt		SZT-22-703MA	1354.74	1423.56	1496.98	1533.72	1561.24	1627.80	1687.44	1850.36	1962.78	2261.62
Back Stop/ Forward Tilt		SZT-22-704MA	1378.84	1447.66	1521.08	1557.82	1585.34	1651.90	1711.54	1874.46	1986.88	2285.72
Lumbar Adjustment - Mesh Back w/Plastic Base												
Pneumatic		SZT-20-712MA	\$1265.26	\$1299.67	\$1336.38	\$1354.75	\$1368.51	\$1401.79	\$1431.61	\$1513.07	\$1569.28	\$1718.70
Back Stop		SZT-20-711MA	1342.12	1376.53	1413.24	1431.61	1445.37	1478.65	1508.47	1589.93	1646.14	1795.56
Forward Tilt		SZT-20-713MA	1342.12	1376.53	1413.24	1431.61	1445.37	1478.65	1508.47	1589.93	1646.14	1795.56
Back Stop/ Forward Tilt		SZT-20-714MA	1366.22	1400.63	1437.34	1455.71	1469.47	1502.75	1532.57	1614.03	1670.24	1819.66
Lumbar Adjustment - Upholstered Back Jacket w/Plastic Base												
Pneumatic		SZT-22-712MA	\$1378.84	\$1447.66	\$1521.08	\$1557.82	\$1585.34	\$1651.90	\$1711.54	\$1874.46	\$1986.88	\$2285.72
Back Stop		SZT-22-711MA	1455.70	1524.52	1597.94	1634.68	1662.20	1728.76	1788.40	1951.32	2063.74	2362.58
Forward Tilt		SZT-22-713MA	1455.70	1524.52	1597.94	1634.68	1662.20	1728.76	1788.40	1951.32	2063.74	2362.58
Back Stop/ Forward Tilt		SZT-22-714MA	1479.80	1548.62	1622.04	1658.78	1686.30	1752.86	1812.50	1975.42	2087.84	2386.68
PAL Back System - Mesh Back w/Plastic Base												
Pneumatic		SZT-20-722MA	\$1291.65	\$1326.06	\$1362.77	\$1381.14	\$1394.90	\$1428.18	\$1458.00	\$1539.46	\$1595.67	\$1745.09
Back Stop		SZT-20-721MA	1368.51	1402.92	1439.63	1458.00	1471.76	1505.04	1534.86	1616.32	1672.53	1821.95
Forward Tilt		SZT-20-723MA	1368.51	1402.92	1439.63	1458.00	1471.76	1505.04	1534.86	1616.32	1672.53	1821.95
Back Stop/ Forward Tilt		SZT-20-724MA	1392.61	1427.02	1463.73	1482.10	1495.86	1529.14	1558.96	1640.42	1696.63	1846.05
PAL Back System - Upholstered Back Jacket w/Plastic Base												
Pneumatic		SZT-22-722MA	\$1405.23	\$1474.05	\$1547.47	\$1584.21	\$1611.73	\$1678.29	\$1737.93	\$1900.85	\$2013.27	\$2312.11
Back Stop		SZT-22-721MA	1482.09	1550.91	1624.33	1661.07	1688.59	1755.15	1814.79	1977.71	2090.13	2388.97
Forward Tilt		SZT-22-723MA	1482.09	1550.91	1624.33	1661.07	1688.59	1755.15	1814.79	1977.71	2090.13	2388.97
Back Stop/ Forward Tilt		SZT-22-724MA	1506.19	1575.01	1648.43	1685.17	1712.69	1779.25	1838.89	2001.81	2114.23	2413.07

The following options require modification of the product number.

- Soft Casters
- Aluminum Base
- Low position pneumatic

To specify, change the 11th digit from a 1 (hard caster) to a 2 (soft caster); **Example:** SZT-20-702MA2

To specify, change the 11th digit from a 5 to a 1 (hard caster) or 2 (soft caster) and add **\$32.78** list

To specify, change the 11th digit from a 1 to a 3 (hard caster) or from a 2 to a 4 (soft caster);

Examples: SZT-20-702MA3 is a low base with hard casters

SZT-20-702MA4 is a low base with soft casters

NOTE: Polished aluminum trim not available with this option.

To specify, change the 10th digit from A to X; **Example:** SZT-20-702MX1

To specify, add **F** to the end of the product number; **Example:** SZT-20-712MA1F (add **\$141.12** list)

To specify, change the 3rd digit from a T to an E; **Example:** SZE-22-702MA1 with headrest (add **\$59.65** list)

To specify, add **P** to end of the product number (add **\$35.57** list)

To specify, change the 4th digit to 1 and 5th digit to 0; **Example:** SZT-10-702MA5

To specify, change the 4th digit to 1 and 5th digit to 1; **Example:** SZT-11-702MA5

To specify, change the 4th digit to 3; **Example:** SZT-30-702MA5

To specify, change the 4th and 5th digits to 33; **Example:** SZT-33-702MA5

NOTE: CAL 133 is available on chairs with black frame and foam seat with or without the Lumbar option.

CAL 133 is not available on chairs with PAL back system.

For available fabrics, refer to surfaces.haworth.com.

Upholstered Gel Insert Seat	Adjustments	Number	Fabric Grade								Leather Grade A	Leather Grade B
			A	B	C	D	E	F	G	H		
No Lumbar Adjustment - Mesh Back w/Plastic Base												
	Pneumatic	SZT-20-702EA	\$1259.53	\$1293.94	\$1330.65	\$1349.02	\$1362.78	\$1396.06	\$1425.88	\$1507.34	\$1563.55	\$1712.97
	Back Stop	SZT-20-701EA	1336.39	1370.80	1407.51	1425.88	1439.64	1472.92	1502.74	1584.20	1640.41	1789.83
	Forward Tilt	SZT-20-703EA	1336.39	1370.80	1407.51	1425.88	1439.64	1472.92	1502.74	1584.20	1640.41	1789.83
	Back Stop/ Forward Tilt	SZT-20-704EA	1360.49	1394.90	1431.61	1449.98	1463.74	1497.02	1526.84	1608.30	1664.51	1813.93
No Lumbar Adjustment - Upholstered Back Jacket w/Plastic Base												
	Pneumatic	SZT-22-702EA	\$1373.11	\$1441.93	\$1515.35	\$1552.09	\$1579.61	\$1646.17	\$1705.81	\$1868.73	\$1981.15	\$2279.99
	Back Stop	SZT-22-701EA	1449.97	1518.79	1592.21	1628.95	1656.47	1723.03	1782.67	1945.59	2058.01	2356.85
	Forward Tilt	SZT-22-703EA	1449.97	1518.79	1592.21	1628.95	1656.47	1723.03	1782.67	1945.59	2058.01	2356.85
	Back Stop/ Forward Tilt	SZT-22-704EA	1474.07	1542.89	1616.31	1653.05	1680.57	1747.13	1806.77	1969.69	2082.11	2380.95
Lumbar Adjustment - Mesh Back w/Plastic Base												
	Pneumatic	SZT-20-712EA	\$1360.49	\$1394.90	\$1431.61	\$1449.98	\$1463.74	\$1497.02	\$1526.84	\$1608.30	\$1664.51	\$1813.93
	Back Stop	SZT-20-711EA	1437.35	1471.76	1508.47	1526.84	1540.60	1573.88	1603.70	1685.16	1741.37	1890.79
	Forward Tilt	SZT-20-713EA	1437.35	1471.76	1508.47	1526.84	1540.60	1573.88	1603.70	1685.16	1741.37	1890.79
	Back Stop/ Forward Tilt	SZT-20-714EA	1461.45	1495.86	1532.57	1550.94	1564.70	1597.98	1627.80	1709.26	1765.47	1914.89
Lumbar Adjustment - Upholstered Back Jacket w/Plastic Base												
	Pneumatic	SZT-22-712EA	\$1474.07	\$1542.89	\$1616.31	\$1653.05	\$1680.57	\$1747.13	\$1806.77	\$1969.69	\$2082.11	\$2380.95
	Back Stop	SZT-22-711EA	1550.93	1619.75	1693.17	1729.91	1757.43	1823.99	1883.63	2046.55	2158.97	2457.81
	Forward Tilt	SZT-22-713EA	1550.93	1619.75	1693.17	1729.91	1757.43	1823.99	1883.63	2046.55	2158.97	2457.81
	Back Stop/ Forward Tilt	SZT-22-714EA	1575.03	1643.85	1717.27	1754.01	1781.53	1848.09	1907.73	2070.65	2183.07	2481.91
PAL Back System - Mesh Back w/Plastic Base												
	Pneumatic	SZT-20-722EA	\$1386.88	\$1421.29	\$1458.00	\$1476.37	\$1490.13	\$1523.41	\$1553.23	\$1634.69	\$1690.90	\$1840.32
	Back Stop	SZT-20-721EA	1463.74	1498.15	1534.86	1553.23	1566.99	1600.27	1630.09	1711.55	1767.76	1917.18
	Forward Tilt	SZT-20-723EA	1463.74	1498.15	1534.86	1553.23	1566.99	1600.27	1630.09	1711.55	1767.76	1917.18
	Back Stop/ Forward Tilt	SZT-20-724EA	1487.84	1522.25	1558.96	1577.33	1591.09	1624.37	1654.19	1735.65	1791.86	1941.28
PAL Back System - Upholstered Back Jacket w/Plastic Base												
	Pneumatic	SZT-22-722EA	\$1500.46	\$1569.28	\$1642.70	\$1679.44	\$1706.96	\$1773.52	\$1833.16	\$1996.08	\$2108.50	\$2407.34
	Back Stop	SZT-22-721EA	1577.32	1646.14	1719.56	1756.30	1783.82	1850.38	1910.02	2072.94	2185.36	2484.20
	Forward Tilt	SZT-22-723EA	1577.32	1646.14	1719.56	1756.30	1783.82	1850.38	1910.02	2072.94	2185.36	2484.20
	Back Stop/ Forward Tilt	SZT-22-724EA	1601.42	1670.24	1743.66	1780.40	1807.92	1874.48	1934.12	2097.04	2209.46	2508.30

The following options require modification of the product number.

Soft Casters
Aluminum Base
Low position pneumatic

Fixed seat
Headrest
Stain repellent
Leather Seat with Mesh Back
Leather Seat with Leather Upholstered Back Jacket
Faux Leather Seat with Mesh Back
Faux Leather Seat with Faux Leather Upholstered Back Jacket

To specify, change the 11th digit from a 1 (hard caster) to a 2 (soft caster); **Example:** SZT-20-702EA2

To specify, change the 11th digit from a 5 to a 1 (hard caster) or 2 (soft caster) and add **\$32.78** list

To specify, change the 11th digit from a 1 to a 3 (hard caster) or from a 2 to a 4 (soft caster);

Examples: SZT-20-702EA3 is a low base with hard casters

SZT-20-702EA4 is a low base with soft casters

NOTE: Polished aluminum trim not available with this option.

To specify, change the 10th digit from A to X; **Example:** SZT-20-702EX1

To specify, change the 3rd digit from a T to an E; **Example:** SZE-22-702EA1 with headrest (add **\$59.65** list)

To specify, add **P** to end of the product number (add **\$35.57** list)

To specify, change the 4th digit to **1** and 5th digit to **0**; **Example:** SZT-10-702EA5

To specify, change the 4th digit to **1** and 5th digit to **1**; **Example:** SZT-11-702EA5

To specify, change the 4th digit to **3**; **Example:** SZT-30-702EA5

To specify, change the 4th and 5th digits to **33**; **Example:** SZT-33-702EA5

NOTE: For available fabrics, refer to surfaces.haworth.com.

This page intentionally blank

Zody

Task Chair with Height Adjustable Arms



SZT-20-402MA1

Dimensions*

- *SH: 16-21"
(406mm-533mm)
- H: 38-43"(965mm-1092mm)
- D: 29"(737mm)
- W: 29"(737mm)
- *SW: 19 1/4"(489mm)
- *AH: 6.8-10.8"
(173mm-274mm)
- *SD: 16-19"(406mm-483mm)

Low position seat height:
14-17"(356mm-432mm)

* All measurements taken with the BIFMA chair measuring device.

Trim Color	Arm Cap & Headrest Color*	
	Black	Smoke
Black (TR-F)	•	
Rusty Red (TR-RR)	•	
Sable (TR-1M)	•	
Smoke (TR-E)		•
Snow (TR-UFM)		•

*Not specifiable.

Features

- Back: Soft mesh only or mesh back with upholstered back jacket.
- Seat: Standard upholstered with foam or optional foam with Technogel® Soft Lite gel insert.
- Seat Type: Standard adjustable [3"(76mm) range] or optional fixed.
- Base: Standard Plastic painted five-star base or optional painted aluminum or polished aluminum. –Plastic base available in Black. –Aluminum base available with painted Black, Rusty Red, Snow, Metallic Silver, Metallic Champagne, Metallic Gunmetal, or optional Polished Aluminum.
- Arms: Height-adjustable with soft arm caps. See matrix for default colors.
- Mechanism: Balanced 3-point tilt; standard tilt tension.
- Height adjustment: Pneumatic or low-position pneumatic.
- Optional Back Stop: Tilt stop in 6 positions.
- Optional Forward Tilt: 5 degrees downward from initial position.
- Optional Back Stop with Forward Tilt
- Optional Asymmetrical Lumbar Adjustment: 4"(102mm) height adjustment; support level can be adjusted independently for right or left hand side of users body. Optional PAL Back System: Passive pelvic support.
- Casters: Standard with hard casters; optional soft casters.
- COM yardage / COL square footage:
Mesh back model: 0.75/10
Mesh back/upholstered back jacket: 1.5/18

NOTE: When specifying fabric or leather back jacket; must also specify mesh surface color for outside back.

Upcharge for mixed grade surfaces, refer to the electronic design and specification tools.

To Order with Fabric or Leather Upholstered Back Jacket Specify:

1) Product number, including:

1 Base/Caster Option:

Aluminum Base

- 1 Aluminum Base, Hard Caster, add **\$32.78** to list
- 2 Aluminum Base, Soft Caster, add **\$32.78** to list
- 3 Aluminum Low Base, Hard Caster, add **\$32.78** to list
- 4 Aluminum Low Base, Soft Caster, add **\$32.78** to list

Plastic Base

- 5 Plastic Std. Base, Hard Caster
- 6 Plastic Std. Base, Soft Caster

- 2) Fabric surface and color (seat).
- 3) Mesh surface color (back).
- 4) Fabric surface and color (back jacket).
- 5) Trim color for frame. (Add **\$56.10** list for Snow.)
- 6) Trim color for base/arms. (Add **\$191.59** list for polished aluminum.)

To Order with Mesh Back Specify:

1) Product number, including:

1 Base/Caster Option:

Aluminum Base

- 1 Aluminum Base, Hard Caster, add **\$32.78** to list
- 2 Aluminum Base, Soft Caster, add **\$32.78** to list
- 3 Aluminum Low Base, Hard Caster, add **\$32.78** to list
- 4 Aluminum Low Base, Soft Caster, add **\$32.78** to list

Plastic Base

- 5 Plastic Std. Base, Hard Caster
- 6 Plastic Std. Base, Soft Caster

- 2) Fabric surface and color (seat).
- 3) Mesh surface and color (back).
- 4) Trim color for frame. (Add **\$56.10** list for Snow.)
- 5) Trim color for base/arms. (Add **\$191.59** list for polished aluminum.)

Zody

Task Chair with Height Adjustable Arms

Upholstered Foam Seat	Adjustments	Number	①	Fabric Grade								Leather Grade A	Leather Grade B
				A	B	C	D	E	F	G	H		
No Lumbar Adjustment - Mesh w/Plastic Base													
Pneumatic		SZT-20-402MA		\$1126.44	\$1160.85	\$1197.56	\$1215.93	\$1229.69	\$1262.97	\$1292.79	\$1374.25	\$1430.46	\$1579.88
Back Stop		SZT-20-401MA		1203.30	1237.71	1274.42	1292.79	1306.55	1339.83	1369.65	1451.11	1507.32	1656.74
Forward Tilt		SZT-20-403MA		1203.30	1237.71	1274.42	1292.79	1306.55	1339.83	1369.65	1451.11	1507.32	1656.74
Back Stop/ Forward Tilt		SZT-20-404MA		1227.40	1261.81	1298.52	1316.89	1330.65	1363.93	1393.75	1475.21	1531.42	1680.84
No Lumbar Adjustment - Upholstered Back Jacket w/Plastic Base													
Pneumatic		SZT-22-402MA		\$1240.02	\$1308.84	\$1382.26	\$1419.00	\$1446.52	\$1513.08	\$1572.72	\$1735.64	\$1848.06	\$2146.90
Back Stop		SZT-22-401MA		1316.88	1385.70	1459.12	1495.86	1523.38	1589.94	1649.58	1812.50	1924.92	2223.76
Forward Tilt		SZT-22-403MA		1316.88	1385.70	1459.12	1495.86	1523.38	1589.94	1649.58	1812.50	1924.92	2223.76
Back Stop/ Forward Tilt		SZT-22-404MA		1340.98	1409.80	1483.22	1519.96	1547.48	1614.04	1673.68	1836.60	1949.02	2247.86
Lumbar Adjustment - Mesh w/Plastic Base													
Pneumatic		SZT-20-412MA		\$1227.40	\$1261.81	\$1298.52	\$1316.89	\$1330.65	\$1363.93	\$1393.75	\$1475.21	\$1531.42	\$1680.84
Back Stop		SZT-20-411MA		1304.26	1338.67	1375.38	1393.75	1407.51	1440.79	1470.61	1552.07	1608.28	1757.70
Forward Tilt		SZT-20-413MA		1304.26	1338.67	1375.38	1393.75	1407.51	1440.79	1470.61	1552.07	1608.28	1757.70
Back Stop/ Forward Tilt		SZT-20-414MA		1328.36	1362.77	1399.48	1417.85	1431.61	1464.89	1494.71	1576.17	1632.38	1781.80
Lumbar Adjustment - Upholstered Back Jacket w/Plastic Base													
Pneumatic		SZT-22-412MA		\$1340.98	\$1409.80	\$1483.22	\$1519.96	\$1547.48	\$1614.04	\$1673.68	\$1836.60	\$1949.02	\$2247.86
Back Stop		SZT-22-411MA		1417.84	1486.66	1560.08	1596.82	1624.34	1690.90	1750.54	1913.46	2025.88	2324.72
Forward Tilt		SZT-22-413MA		1417.84	1486.66	1560.08	1596.82	1624.34	1690.90	1750.54	1913.46	2025.88	2324.72
Back Stop/ Forward Tilt		SZT-22-414MA		1441.94	1510.76	1584.18	1620.92	1648.44	1715.00	1774.64	1937.56	2049.98	2348.82
PAL Back System - Mesh w/Plastic Base													
Pneumatic		SZT-20-422MA		\$1253.79	\$1288.20	\$1324.91	\$1343.28	\$1357.04	\$1390.32	\$1420.14	\$1501.60	\$1557.81	\$1707.23
Back Stop		SZT-20-421MA		1330.65	1365.06	1401.77	1420.14	1433.90	1467.18	1497.00	1578.46	1634.67	1784.09
Forward Tilt		SZT-20-423MA		1330.65	1365.06	1401.77	1420.14	1433.90	1467.18	1497.00	1578.46	1634.67	1784.09
Back Stop/ Forward Tilt		SZT-20-424MA		1354.75	1389.16	1425.87	1444.24	1458.00	1491.28	1521.10	1602.56	1658.77	1808.19
PAL Back System - Upholstered Back Jacket w/Plastic Base													
Pneumatic		SZT-22-422MA		\$1367.37	\$1436.19	\$1509.61	\$1546.35	\$1573.87	\$1640.43	\$1700.07	\$1862.99	\$1975.41	\$2274.25
Back Stop		SZT-22-421MA		1444.23	1513.05	1586.47	1623.21	1650.73	1717.29	1776.93	1939.85	2052.27	2351.11
Forward Tilt		SZT-22-423MA		1444.23	1513.05	1586.47	1623.21	1650.73	1717.29	1776.93	1939.85	2052.27	2351.11
Back Stop/ Forward Tilt		SZT-22-424MA		1468.33	1537.15	1610.57	1647.31	1674.83	1741.39	1801.03	1963.95	2076.37	2375.21

The following options require modification of the product number.

- Soft Casters
- Aluminum Base
- Low position pneumatic

To specify, change the 11th digit from a 1 (hard caster) to a 2 (soft caster); **Example:** SZT-20-402MA2

To specify, change the 11th digit from a 5 to a 1 (hard caster) or 2 (soft caster) and add **\$32.78** list

To specify, change the 11th digit from a 1 to a 3 (hard caster) or from a 2 to a 4 (soft caster);

Examples: SZT-20-402MA3 is a low base with hard casters

SZT-20-402MA4 is a low base with soft casters

NOTE: Polished aluminum trim not available with this option.

To specify, change the 10th digit from A to X; **Example:** SZT-20-402MX1

To specify, add **F** to the end of the product number; **Example:** SZT-20-401MA1F (add **\$141.12** list)

To specify, change the 3rd digit from a T to an E; **Example:** SZE-22-402MA1 with headrest (add **\$59.65** list)

To specify, add **P** to end of the product number (add **\$35.57** list)

To specify, change the 4th digit to **1** and 5th digit to **0**; **Example:** SZT-10-402MA5

To specify, change the 4th digit to **1** and 5th digit to **1**; **Example:** SZT-11-402MA5

To specify, change the 4th digit to **3**; **Example:** SZT-30-402MA5

To specify, change the 4th and 5th digits to **33**; **Example:** SZT-33-402MA5

NOTE: CAL 133 is available on chairs with black frame and foam seat with or without the Lumbar option.

CAL 133 is not available on chairs with PAL back system.

For available fabrics, refer to surfaces.haworth.com.

Upholstered Gel Insert Seat	Adjustments	Number	①	Fabric Grade								Leather Grade A	Leather Grade B
				A	B	C	D	E	F	G	H		
No Lumbar Adjustment - Mesh w/Plastic Base													
	Pneumatic	SZT-20-402EA		\$1221.67	\$1256.08	\$1292.79	\$1311.16	\$1324.92	\$1358.20	\$1388.02	\$1469.48	\$1525.69	\$1675.11
	Back Stop	SZT-20-401EA		1298.53	1332.94	1369.65	1388.02	1401.78	1435.06	1464.88	1546.34	1602.55	1751.97
	Forward Tilt	SZT-20-403EA		1298.53	1332.94	1369.65	1388.02	1401.78	1435.06	1464.88	1546.34	1602.55	1751.97
	Back Stop/ Forward Tilt	SZT-20-404EA		1322.63	1357.04	1393.75	1412.12	1425.88	1459.16	1488.98	1570.44	1626.65	1776.07
No Lumbar Adjustment - Upholstered Back Jacket w/Plastic Base													
	Pneumatic	SZT-22-402EA		\$1335.25	\$1404.07	\$1477.49	\$1514.23	\$1541.75	\$1608.31	\$1667.95	\$1830.87	\$1943.29	\$2242.13
	Back Stop	SZT-22-401EA		1412.11	1480.93	1554.35	1591.09	1618.61	1685.17	1744.81	1907.73	2020.15	2318.99
	Forward Tilt	SZT-22-403EA		1412.11	1480.93	1554.35	1591.09	1618.61	1685.17	1744.81	1907.73	2020.15	2318.99
	Back Stop/ Forward Tilt	SZT-22-404EA		1436.21	1505.03	1578.45	1615.19	1642.71	1709.27	1768.91	1931.83	2044.25	2343.09
Lumbar Adjustment - Mesh w/Plastic Base													
	Pneumatic	SZT-20-412EA		\$1322.63	\$1357.04	\$1393.75	\$1412.12	\$1425.88	\$1459.16	\$1488.98	\$1570.44	\$1626.65	\$1776.07
	Back Stop	SZT-20-411EA		1399.49	1433.90	1470.61	1488.98	1502.74	1536.02	1565.84	1647.30	1703.51	1852.93
	Forward Tilt	SZT-20-413EA		1399.49	1433.90	1470.61	1488.98	1502.74	1536.02	1565.84	1647.30	1703.51	1852.93
	Back Stop/ Forward Tilt	SZT-20-414EA		1423.59	1458.00	1494.71	1513.08	1526.84	1560.12	1589.94	1671.40	1727.61	1877.03
Lumbar Adjustment - Upholstered Back Jacket w/Plastic Base													
	Pneumatic	SZT-22-412EA		\$1436.21	\$1505.03	\$1578.45	\$1615.19	\$1642.71	\$1709.27	\$1768.91	\$1931.83	\$2044.25	\$2343.09
	Back Stop	SZT-22-411EA		1513.07	1581.89	1655.31	1692.05	1719.57	1786.13	1845.77	2008.69	2121.11	2419.95
	Forward Tilt	SZT-22-413EA		1513.07	1581.89	1655.31	1692.05	1719.57	1786.13	1845.77	2008.69	2121.11	2419.95
	Back Stop/ Forward Tilt	SZT-22-414EA		1537.17	1605.99	1679.41	1716.15	1743.67	1810.23	1869.87	2032.79	2145.21	2444.05
PAL Back System - Mesh w/Plastic Base													
	Pneumatic	SZT-20-422EA		\$1349.02	\$1383.43	\$1420.14	\$1438.51	\$1452.27	\$1485.55	\$1515.37	\$1596.83	\$1653.04	\$1802.46
	Back Stop	SZT-20-421EA		1425.88	1460.29	1497.00	1515.37	1529.13	1562.41	1592.23	1673.69	1729.90	1879.32
	Forward Tilt	SZT-20-423EA		1425.88	1460.29	1497.00	1515.37	1529.13	1562.41	1592.23	1673.69	1729.90	1879.32
	Back Stop/ Forward Tilt	SZT-20-424EA		1449.98	1484.39	1521.10	1539.47	1553.23	1586.51	1616.33	1697.79	1754.00	1903.42
PAL Back System - Upholstered Back Jacket w/Plastic Base													
	Pneumatic	SZT-22-422EA		\$1462.60	\$1531.42	\$1604.84	\$1641.58	\$1669.10	\$1735.66	\$1795.30	\$1958.22	\$2070.64	\$2369.48
	Back Stop	SZT-22-421EA		1539.46	1608.28	1681.70	1718.44	1745.96	1812.52	1872.16	2035.08	2147.50	2446.34
	Forward Tilt	SZT-22-423EA		1539.46	1608.28	1681.70	1718.44	1745.96	1812.52	1872.16	2035.08	2147.50	2446.34
	Back Stop/ Forward Tilt	SZT-22-424EA		1563.56	1632.38	1705.80	1742.54	1770.06	1836.62	1896.26	2059.18	2171.60	2470.44

The following options require modification of the product number.

Soft Casters
Aluminum Base
Low position pneumatic

Fixed seat
Headrest
Stain repellent
Leather Seat with Mesh Back
Leather Seat with Leather Upholstered Back Jacket
Faux Leather Seat with Mesh Back
Faux Leather Seat with Faux Leather Upholstered Back Jacket

To specify, change the 11th digit from a 1 (hard caster) to a 2 (soft caster); **Example:** SZT-20-402EA2

To specify, change the 11th digit from a 5 to a 1 (hard caster) or 2 (soft caster) and add **\$32.78** list

To specify, change the 11th digit from a 1 to a 3 (hard caster) or from a 2 to a 4 (soft caster);

Examples: SZT-20-402EA3 is a low base with hard casters

SZT-20-402EA4 is a low base with soft casters

NOTE: Polished aluminum trim not available with this option.

To specify, change the 10th digit from A to X; **Example:** SZT-20-402EX1

To specify, change the 3rd digit from a T to an E; **Example:** SZE-22-402EA1 with headrest (add **\$59.65** list)

To specify, add **P** to end of the product number (add **\$35.57** list)

To specify, change the 4th digit to 1 and 5th digit to 0; **Example:** SZT-10-402EA5

To specify, change the 4th digit to 1 and 5th digit to 1; **Example:** SZT-11-402EA5

To specify, change the 4th digit to 3; **Example:** SZT-30-402EA5

To specify, change the 4th and 5th digits to 33; **Example:** SZT-33-402EA5

NOTE: For available fabrics, refer to surfaces.haworth.com.

This page intentionally blank

Zody

Task Chair with Fixed Arms



SZT-20-102MA1

Dimensions*

*SH: 16-21"
(406mm-533mm)
H: 38-43"(965mm-1092mm)
D: 29"(737mm)
W: 29"(737mm)
*SW: 19 1/4"(489mm)
*AH: 9"(229mm)
*SD: 16-19"(406mm-483mm)
Low position seat height:
14-17"(356mm-432mm)

* All measurements taken with the BIFMA chair measuring device.

Features

- Back: Soft mesh only or mesh back with upholstered back jacket.
- Seat: Standard upholstered with foam or optional foam with Technogel® Soft Lite gel insert.
- Seat Type: Standard adjustable [3"(76mm) range] or optional fixed.
- Base: Standard Plastic painted five-star base or optional painted aluminum or polished aluminum. –Plastic base available in Black. –Aluminum base available with painted Black, Rusty Red, Snow, Metallic Silver, Metallic Champagne, Metallic Gunmetal, or optional Polished Aluminum.
- Arms: Fixed with soft arm caps. See matrix for default colors.
- Mechanism: Balanced 3-point tilt; standard tilt tension.
- Height adjustment: Pneumatic or low-position pneumatic.
- Optional Back Stop: Tilt stop in 6 positions.
- Optional Forward Tilt: 5 degrees downward from initial position.
- Optional Back Stop with Forward Tilt
- Optional Asymmetrical Lumbar Adjustment: 4"(102mm) height adjustment; support level can be adjusted independently for right or left hand side of users body. Optional PAL Back System: Passive pelvic support.
- Casters: Standard with hard casters; optional soft casters.
- COM yardage / COL square footage:
Mesh back model: 0.75/10
Mesh back/upholstered back jacket: 1.5/18

NOTE: When specifying fabric or leather back jacket; must also specify mesh surface color for outside back.

Upcharge for mixed grade surfaces, refer to the electronic design and specification tools.

To Order with Fabric or Leather Upholstered Back Jacket Specify:

1) Product number, including:

1 Base/Caster Option:**Aluminum Base**

- 1 Aluminum Base, Hard Caster, add **\$32.78** to list
- 2 Aluminum Base, Soft Caster, add **\$32.78** to list
- 3 Aluminum Low Base, Hard Caster, add **\$32.78** to list
- 4 Aluminum Low Base, Soft Caster, add **\$32.78** to list

Plastic Base

- 5 Plastic Std. Base, Hard Caster
- 6 Plastic Std. Base, Soft Caster

2) Fabric surface and color (seat).

3) Mesh surface color (back).

4) Fabric surface and color (back jacket).

5) Trim color for frame. (Add **\$56.10** list for Snow.)

6) Trim color for base/arms. (Add **\$191.59** list for polished aluminum.)

To Order with Mesh Back Specify:

1) Product number, including:

1 Base/Caster Option:**Aluminum Base**

- 1 Aluminum Base, Hard Caster, add **\$32.78** to list
- 2 Aluminum Base, Soft Caster, add **\$32.78** to list
- 3 Aluminum Low Base, Hard Caster, add **\$32.78** to list
- 4 Aluminum Low Base, Soft Caster, add **\$32.78** to list

Plastic Base

- 5 Plastic Std. Base, Hard Caster
- 6 Plastic Std. Base, Soft Caster

2) Fabric surface and color (seat).

3) Mesh surface and color (back).

4) Trim color for frame. (Add **\$56.10** list for Snow.)

5) Trim color for base/arms. (Add **\$191.59** list for polished aluminum.)

Trim Color	Arm Cap & Headrest Color*	
	Black	Smoke
Black (TR-F)	•	
Rusty Red (TR-RR)	•	
Sable (TR-1M)	•	
Smoke (TR-E)		•
Snow (TR-UFM)		•

*Not specifiable.

Zody

Task Chair with Fixed Arms

Upholstered Foam Seat	Adjustments	Number	Fabric Grade								Leather Grade A	Leather Grade B
			A	B	C	D	E	F	G	H		
No Lumbar Adjustment - Mesh Back w/Plastic Base												
	Pneumatic	SZT-20-102MA	\$1048.43	\$1082.84	\$1119.55	\$1137.92	\$1151.68	\$1184.96	\$1214.78	\$1296.24	\$1352.45	\$1501.87
	Back Stop	SZT-20-101MA	1125.29	1159.70	1196.41	1214.78	1228.54	1261.82	1291.64	1373.10	1429.31	1578.73
	Forward Tilt	SZT-20-103MA	1125.29	1159.70	1196.41	1214.78	1228.54	1261.82	1291.64	1373.10	1429.31	1578.73
	Back Stop/ Forward Tilt	SZT-20-104MA	1149.39	1183.80	1220.51	1238.88	1252.64	1285.92	1315.74	1397.20	1453.41	1602.83
No Lumbar Adjustment - Upholstered Back Jacket w/Plastic Base												
	Pneumatic	SZT-22-102MA	\$1162.01	\$1230.83	\$1304.25	\$1340.99	\$1368.51	\$1435.07	\$1494.71	\$1657.63	\$1770.05	\$2068.89
	Back Stop	SZT-22-101MA	1238.87	1307.69	1381.11	1417.85	1445.37	1511.93	1571.57	1734.49	1846.91	2145.75
	Forward Tilt	SZT-22-103MA	1238.87	1307.69	1381.11	1417.85	1445.37	1511.93	1571.57	1734.49	1846.91	2145.75
	Back Stop/ Forward Tilt	SZT-22-104MA	1262.97	1331.79	1405.21	1441.95	1469.47	1536.03	1595.67	1758.59	1871.01	2169.85
Lumbar Adjustment - Mesh Back w/Plastic Base												
	Pneumatic	SZT-20-112MA	\$1149.39	\$1183.80	\$1220.51	\$1238.88	\$1252.64	\$1285.92	\$1315.74	\$1397.20	\$1453.41	\$1602.83
	Back Stop	SZT-20-111MA	1226.25	1260.66	1297.37	1315.74	1329.50	1362.78	1392.60	1474.06	1530.27	1679.69
	Forward Tilt	SZT-20-113MA	1226.25	1260.66	1297.37	1315.74	1329.50	1362.78	1392.60	1474.06	1530.27	1679.69
	Back Stop/ Forward Tilt	SZT-20-114MA	1250.35	1284.76	1321.47	1339.84	1353.60	1386.88	1416.70	1498.16	1554.37	1703.79
Lumbar Adjustment - Upholstered Back Jacket w/Plastic Base												
	Pneumatic	SZT-22-112MA	\$1262.97	\$1331.79	\$1405.21	\$1441.95	\$1469.47	\$1536.03	\$1595.67	\$1758.59	\$1871.01	\$2169.85
	Back Stop	SZT-22-111MA	1339.83	1408.65	1482.07	1518.81	1546.33	1612.89	1672.53	1835.45	1947.87	2246.71
	Forward Tilt	SZT-22-113MA	1339.83	1408.65	1482.07	1518.81	1546.33	1612.89	1672.53	1835.45	1947.87	2246.71
	Back Stop/ Forward Tilt	SZT-22-114MA	1363.93	1432.75	1506.17	1542.91	1570.43	1636.99	1696.63	1859.55	1971.97	2270.81
PAL Back System - Mesh Back w/Plastic Base												
	Pneumatic	SZT-20-122MA	\$1175.78	\$1210.19	\$1246.90	\$1265.27	\$1279.03	\$1312.31	\$1342.13	\$1423.59	\$1479.80	\$1629.22
	Back Stop	SZT-20-121MA	1252.64	1287.05	1323.76	1342.13	1355.89	1389.17	1418.99	1500.45	1556.66	1706.08
	Forward Tilt	SZT-20-123MA	1252.64	1287.05	1323.76	1342.13	1355.89	1389.17	1418.99	1500.45	1556.66	1706.08
	Back Stop/ Forward Tilt	SZT-20-124MA	1276.74	1311.15	1347.86	1366.23	1379.99	1413.27	1443.09	1524.55	1580.76	1730.18
PAL Back System - Upholstered Back Jacket w/Plastic Base												
	Pneumatic	SZT-22-122MA	\$1289.36	\$1358.18	\$1431.60	\$1468.34	\$1495.86	\$1562.42	\$1622.06	\$1784.98	\$1897.40	\$2196.24
	Back Stop	SZT-22-121MA	1366.22	1435.04	1508.46	1545.20	1572.72	1639.28	1698.92	1861.84	1974.26	2273.10
	Forward Tilt	SZT-22-123MA	1366.22	1435.04	1508.46	1545.20	1572.72	1639.28	1698.92	1861.84	1974.26	2273.10
	Back Stop/ Forward Tilt	SZT-22-124MA	1390.32	1459.14	1532.56	1569.30	1596.82	1663.38	1723.02	1885.94	1998.36	2297.20

The following options require modification of the product number.

- Soft Casters
- Aluminum Base
- Low position pneumatic

To specify, change the 11th digit from a 1 (hard caster) to a 2 (soft caster); **Example:** SZT-20-102MA2

To specify, change the 11th digit from a 5 to a 1 (hard caster) or 2 (soft caster) and add **\$32.78** list

To specify, change the 11th digit from a 1 to a 3 (hard caster) or from a 2 to a 4 (soft caster);

Examples: SZT-20-102MA3 is a low base with hard casters

SZT-20-102MA4 is a low base with soft casters

NOTE: Polished aluminum trim not available with this option.

To specify, change the 10th digit from A to X; **Example:** SZT-20-102MX1

To specify, add **F** to the end of the product number; **Example:** SZT-22-101MA1F (add **\$141.12** list)

To specify, change the 3rd digit from a T to an E; **Example:** SZE-22-102MA1 with headrest (add **\$59.65** list)

To specify, add **P** to end of the product number (add **\$35.57** list)

To specify, change the 4th digit to 1 and 5th digit to 0; **Example:** SZT-10-102MA5

To specify, change the 4th digit to 1 and 5th digit to 1; **Example:** SZT-11-102MA5

To specify, change the 4th digit to 3; **Example:** SZT-30-102MA5

To specify, change the 4th and 5th digits to 33; **Example:** SZT-33-102MA5

NOTE: CAL 133 is available on chairs with black frame and foam seat with or without the Lumbar option.

CAL 133 is not available on chairs with PAL back system.

For available fabrics, refer to surfaces.haworth.com.

Zody

Task Chair with Fixed Arms

Upholstered Gel Insert Seat	Adjustments	Number	①	Fabric Grade								Leather Grade A	Leather Grade B
				A	B	C	D	E	F	G	H		
No Lumbar Adjustment - Mesh Back w/Plastic Base													
	Pneumatic	SZT-20-102EA		\$1143.66	\$1178.07	\$1214.78	\$1233.15	\$1246.91	\$1280.19	\$1310.01	\$1391.47	\$1447.68	\$1597.10
	Back Stop	SZT-20-101EA		1220.52	1254.93	1291.64	1310.01	1323.77	1357.05	1386.87	1468.33	1524.54	1673.96
	Forward Tilt	SZT-20-103EA		1220.52	1254.93	1291.64	1310.01	1323.77	1357.05	1386.87	1468.33	1524.54	1673.96
	Back Stop/ Forward Tilt	SZT-20-104EA		1244.62	1279.03	1315.74	1334.11	1347.87	1381.15	1410.97	1492.43	1548.64	1698.06
No Lumbar Adjustment - Upholstered Back Jacket w/Plastic Base													
	Pneumatic	SZT-22-102EA		\$1257.24	\$1326.06	\$1399.48	\$1436.22	\$1463.74	\$1530.30	\$1589.94	\$1752.86	\$1865.28	\$2164.12
	Back Stop	SZT-22-101EA		1334.10	1402.92	1476.34	1513.08	1540.60	1607.16	1666.80	1829.72	1942.14	2240.98
	Forward Tilt	SZT-22-103EA		1334.10	1402.92	1476.34	1513.08	1540.60	1607.16	1666.80	1829.72	1942.14	2240.98
	Back Stop/ Forward Tilt	SZT-22-104EA		1358.20	1427.02	1500.44	1537.18	1564.70	1631.26	1690.90	1853.82	1966.24	2265.08
Lumbar Adjustment - Mesh Back w/Plastic Base													
	Pneumatic	SZT-20-112EA		\$1244.62	\$1279.03	\$1315.74	\$1334.11	\$1347.87	\$1381.15	\$1410.97	\$1492.43	\$1548.64	\$1698.06
	Back Stop	SZT-20-111EA		1321.48	1355.89	1392.60	1410.97	1424.73	1458.01	1487.83	1569.29	1625.50	1774.92
	Forward Tilt	SZT-20-113EA		1321.48	1355.89	1392.60	1410.97	1424.73	1458.01	1487.83	1569.29	1625.50	1774.92
	Back Stop/ Forward Tilt	SZT-20-114EA		1345.58	1379.99	1416.70	1435.07	1448.83	1482.11	1511.93	1593.39	1649.60	1799.02
Lumbar Adjustment - Upholstered Back Jacket w/Plastic Base													
	Pneumatic	SZT-22-112EA		\$1358.20	\$1427.02	\$1500.44	\$1537.18	\$1564.70	\$1631.26	\$1690.90	\$1853.82	\$1966.24	\$2265.08
	Back Stop	SZT-22-111EA		1435.06	1503.88	1577.30	1614.04	1641.56	1708.12	1767.76	1930.68	2043.10	2341.94
	Forward Tilt	SZT-22-113EA		1435.06	1503.88	1577.30	1614.04	1641.56	1708.12	1767.76	1930.68	2043.10	2341.94
	Back Stop/ Forward Tilt	SZT-22-114EA		1459.16	1527.98	1601.40	1638.14	1665.66	1732.22	1791.86	1954.78	2067.20	2366.04
PAL Back System - Mesh Back w/Plastic Base													
	Pneumatic	SZT-20-122EA		\$1271.01	\$1305.42	\$1342.13	\$1360.50	\$1374.26	\$1407.54	\$1437.36	\$1518.82	\$1575.03	\$1724.45
	Back Stop	SZT-20-121EA		1347.87	1382.28	1418.99	1437.36	1451.12	1484.40	1514.22	1595.68	1651.89	1801.31
	Forward Tilt	SZT-20-123EA		1347.87	1382.28	1418.99	1437.36	1451.12	1484.40	1514.22	1595.68	1651.89	1801.31
	Back Stop/ Forward Tilt	SZT-20-124EA		1371.97	1406.38	1443.09	1461.46	1475.22	1508.50	1538.32	1619.78	1675.99	1825.41
PAL Back System - Upholstered Back Jacket w/Plastic Base													
	Pneumatic	SZT-22-122EA		\$1384.59	\$1453.41	\$1526.83	\$1563.57	\$1591.09	\$1657.65	\$1717.29	\$1880.21	\$1992.63	\$2291.47
	Back Stop	SZT-22-121EA		1461.45	1530.27	1603.69	1640.43	1667.95	1734.51	1794.15	1957.07	2069.49	2368.33
	Forward Tilt	SZT-22-123EA		1461.45	1530.27	1603.69	1640.43	1667.95	1734.51	1794.15	1957.07	2069.49	2368.33
	Back Stop/ Forward Tilt	SZT-22-124EA		1485.55	1554.37	1627.79	1664.53	1692.05	1758.61	1818.25	1981.17	2093.59	2392.43

The following options require modification of the product number.

- Soft Casters
- Aluminum Base
- Low position pneumatic

- Fixed seat
- Headrest
- Stain repellent
- Leather Seat with Mesh Back
- Leather Seat with Leather Upholstered Back Jacket
- Faux Leather Seat with Mesh Back
- Faux Leather Seat with Faux Leather Upholstered Back Jacket

To specify, change the 11th digit from a 1 (hard caster) to a 2 (soft caster); **Example:** SZT-20-102EA2
 To specify, change the 11th digit from a 5 to a 1 (hard caster) or 2 (soft caster) and add **\$32.78** list
 To specify, change the 11th digit from a 1 to a 3 (hard caster) or from a 2 to a 4 (soft caster);
Examples: SZT-20-102EA3 is a low base with hard casters
 SZT-20-102EA4 is a low base with soft casters
NOTE: Polished aluminum trim not available with this option.
 To specify, change the 10th digit from A to X; **Example:** SZT-20-102EX1
 To specify, change the 3rd digit from a T to an E; **Example:** SZE-22-102EA1 with headrest (add **\$59.65** list)
 To specify, add **P** to end of the product number (add **\$35.57** list)
 To specify, change the 4th digit to 1 and 5th digit to 0; **Example:** SZT-10-102EA5
 To specify, change the 4th digit to 1 and 5th digit to 1; **Example:** SZT-11-102EA5
 To specify, change the 4th digit to 3; **Example:** SZT-30-102EA5
 To specify, change the 4th and 5th digits to 33; **Example:** SZT-33-102EA5
NOTE: For available fabrics, refer to surfaces.haworth.com.

This page intentionally blank

Zody

Task Chair without Arms



SZT-20-002MA1

Dimensions*

- *SH: 16-21" (406mm-533mm)
- H: 38-43" (965mm-1092mm)
- D: 29" (737mm)
- W: 29" (737mm)
- *SW: 19 1/4" (489mm)
- *SD: 16-19" (406mm-483mm)

Low position seat height:
14-17" (356mm-432mm)

* All measurements taken with the BIFMA chair measuring device.

Trim Color	Headrest Color*	
	Black	Smoke
Black (TR-F)	•	
Rusty Red (TR-RR)	•	
Sable (TR-1M)	•	
Smoke (TR-E)		•
Snow (TR-UFM)		•

*Not specifiable.

Features

- Back: Soft mesh only or mesh back with upholstered back jacket.
- Seat: Standard upholstered with foam or optional foam with Technogel® Soft Lite gel insert.
- Seat Type: Standard adjustable [3" (76mm) range] or optional fixed.
- Base: Standard Plastic painted five-star base or optional painted aluminum or polished aluminum. –Plastic base available in Black. –Aluminum base available with painted Black, Rusty Red, Snow, Metallic Silver, Metallic Champagne, Metallic Gunmetal, or optional Polished Aluminum.
- Mechanism: Balanced 3-point tilt; standard tilt tension.
- Height adjustment: Pneumatic or low-position pneumatic.
- Optional Back Stop: Tilt stop in 6 positions.
- Optional Forward Tilt: 5 degrees downward from initial position.
- Optional Back Stop with Forward Tilt
- Optional Asymmetrical Lumbar Adjustment: 4" (102mm) height adjustment; support level can be adjusted independently for right or left hand side of users body. Optional PAL Back System: Passive pelvic support
- Casters: Standard with hard casters; optional soft casters.
- COM yardage / COL square footage:
Mesh back model: 0.75/10
Mesh back/upholstered back jacket: 1.5/18

NOTE: When specifying fabric or leather back jacket; must also specify mesh surface color for outside back.

Upcharge for mixed grade surfaces, refer to the electronic design and specification tools.

To Order with Fabric or Leather Upholstered Back Jacket Specify:

1) Product number, including:

1 Base/Caster Option:

Aluminum Base

- 1 Aluminum Base, Hard Caster, add **\$32.78** to list
- 2 Aluminum Base, Soft Caster, add **\$32.78** to list
- 3 Aluminum Low Base, Hard Caster, add **\$32.78** to list
- 4 Aluminum Low Base, Soft Caster, add **\$32.78** to list

Plastic Base

- 5 Plastic Std. Base, Hard Caster
- 6 Plastic Std. Base, Soft Caster

- 2) Fabric surface and color (seat).
- 3) Mesh surface color (back).
- 4) Fabric surface and color (back jacket).
- 5) Trim color for frame. (Add **\$56.10** list for Snow.)
- 6) Trim color for base. (Add **\$191.59** list for polished aluminum.)

To Order with Mesh Back Specify:

1) Product number, including:

1 Base/Caster Option:

Aluminum Base

- 1 Aluminum Base, Hard Caster, add **\$32.78** to list
- 2 Aluminum Base, Soft Caster, add **\$32.78** to list
- 3 Aluminum Low Base, Hard Caster, add **\$32.78** to list
- 4 Aluminum Low Base, Soft Caster, add **\$32.78** to list

Plastic Base

- 5 Plastic Std. Base, Hard Caster
- 6 Plastic Std. Base, Soft Caster

- 2) Fabric surface and color (seat).
- 3) Mesh surface and color (back).
- 4) Trim color for frame. (Add **\$56.10** list for Snow.)
- 5) Trim color for base. (Add **\$191.59** list for polished aluminum.)

Zody

Task Chair without Arms

Upholstered Foam Seat	Adjustments	Number	①	Fabric Grade								Leather Grade A	Leather Grade B
				A	B	C	D	E	F	G	H		
No Lumbar Adjustment - Mesh Back w/Plastic Base													
Pneumatic		SZT-20-002MA		\$ 921.08	\$ 955.49	\$ 992.20	\$1010.57	\$1024.33	\$1057.61	\$1087.43	\$1168.89	\$1225.10	\$1374.52
Back Stop		SZT-20-001MA		997.94	1032.35	1069.06	1087.43	1101.19	1134.47	1164.29	1245.75	1301.96	1451.38
Forward Tilt		SZT-20-003MA		997.94	1032.35	1069.06	1087.43	1101.19	1134.47	1164.29	1245.75	1301.96	1451.38
Back Stop/ Forward Tilt		SZT-20-004MA		1022.04	1056.45	1093.16	1111.53	1125.29	1158.57	1188.39	1269.85	1326.06	1475.48
No Lumbar Adjustment - Upholstered Back Jacket w/Plastic Base													
Pneumatic		SZT-22-002MA		\$1034.66	\$1103.48	\$1176.90	\$1213.64	\$1241.16	\$1307.72	\$1367.36	\$1530.28	\$1642.70	\$1941.54
Back Stop		SZT-22-001MA		1111.52	1180.34	1253.76	1290.50	1318.02	1384.58	1444.22	1607.14	1719.56	2018.40
Forward Tilt		SZT-22-003MA		1111.52	1180.34	1253.76	1290.50	1318.02	1384.58	1444.22	1607.14	1719.56	2018.40
Back Stop/ Forward Tilt		SZT-22-004MA		1135.62	1204.44	1277.86	1314.60	1342.12	1408.68	1468.32	1631.24	1743.66	2042.50
Lumbar Adjustment - Mesh Back w/Plastic Base													
Pneumatic		SZT-20-012MA		\$1022.04	\$1056.45	\$1093.16	\$1111.53	\$1125.29	\$1158.57	\$1188.39	\$1269.85	\$1326.06	\$1475.48
Back Stop		SZT-20-011MA		1098.90	1133.31	1170.02	1188.39	1202.15	1235.43	1265.25	1346.71	1402.92	1552.34
Forward Tilt		SZT-20-013MA		1098.90	1133.31	1170.02	1188.39	1202.15	1235.43	1265.25	1346.71	1402.92	1552.34
Back Stop/ Forward Tilt		SZT-20-014MA		1123.00	1157.41	1194.12	1212.49	1226.25	1259.53	1289.35	1370.81	1427.02	1576.44
Lumbar Adjustment - Upholstered Back Jacket w/Plastic Base													
Pneumatic		SZT-22-012MA		\$1135.62	\$1204.44	\$1277.86	\$1314.60	\$1342.12	\$1408.68	\$1468.32	\$1631.24	\$1743.66	\$2042.50
Back Stop		SZT-22-011MA		1212.48	1281.30	1354.72	1391.46	1418.98	1485.54	1545.18	1708.10	1820.52	2119.36
Forward Tilt		SZT-22-013MA		1212.48	1281.30	1354.72	1391.46	1418.98	1485.54	1545.18	1708.10	1820.52	2119.36
Back Stop/ Forward Tilt		SZT-22-014MA		1236.58	1305.40	1378.82	1415.56	1443.08	1509.64	1569.28	1732.20	1844.62	2143.46
PAL Back System - Mesh Back w/Plastic Base													
Pneumatic		SZT-20-022MA		\$1048.43	\$1082.84	\$1119.55	\$1137.92	\$1151.68	\$1184.96	\$1214.78	\$1296.24	\$1352.45	\$1501.87
Back Stop		SZT-20-021MA		1125.29	1159.70	1196.41	1214.78	1228.54	1261.82	1291.64	1373.10	1429.31	1578.73
Forward Tilt		SZT-20-023MA		1125.29	1159.70	1196.41	1214.78	1228.54	1261.82	1291.64	1373.10	1429.31	1578.73
Back Stop/ Forward Tilt		SZT-20-024MA		1149.39	1183.80	1220.51	1238.88	1252.64	1285.92	1315.74	1397.20	1453.41	1602.83
PAL Back System - Upholstered Back Jacket w/Plastic Base													
Pneumatic		SZT-22-022MA		\$1162.01	\$1230.83	\$1304.25	\$1340.99	\$1368.51	\$1435.07	\$1494.71	\$1657.63	\$1770.05	\$2068.89
Back Stop		SZT-22-021MA		1238.87	1307.69	1381.11	1417.85	1445.37	1511.93	1571.57	1734.49	1846.91	2145.75
Forward Tilt		SZT-22-023MA		1238.87	1307.69	1381.11	1417.85	1445.37	1511.93	1571.57	1734.49	1846.91	2145.75
Back Stop/ Forward Tilt		SZT-22-024MA		1262.97	1331.79	1405.21	1441.95	1469.47	1536.03	1595.67	1758.59	1871.01	2169.85

The following options require modification of the product number.

- Soft Casters
- Aluminum Base
- Low position pneumatic

To specify, change the 11th digit from a 1 (hard caster) to a 2 (soft caster); **Example:** SZT-20-002MA2

To specify, change the 11th digit from a 5 to a 1 (hard caster) or 2 (soft caster) and add **\$32.78** list

To specify, change the 11th digit from a 1 to a 3 (hard caster) or from a 2 to a 4 (soft caster);

Examples: SZT-20-002MA3 is a low base with hard casters

SZT-20-002MA4 is a low base with soft casters

NOTE: Polished aluminum trim not available with this option.

To specify, change the 10th digit from A to X; **Example:** SZT-20-002MX1

To specify, add **F** to the end of the product number; **Example:** SZT-20-002MA1F (add **\$141.12** list)

To specify, change the 3rd digit from a T to an E; **Example:** SZE-22-002MA1 with headrest (add **\$59.65** list)

To specify, add **P** to end of the product number (add **\$35.57** list)

To specify, change the 4th digit to **1** and 5th digit to **0**; **Example:** SZT-10-002MA5

To specify, change the 4th digit to **1** and 5th digit to **1**; **Example:** SZT-11-002MA5

To specify, change the 4th digit to **3**; **Example:** SZT-30-002MA5

To specify, change the 4th and 5th digits to **33**; **Example:** SZT-33-002MA5

NOTE: CAL 133 is available on chairs with black frame and foam seat with or without the Lumbar option.

CAL 133 is not available on chairs with PAL back system.

For available fabrics, refer to surfaces.haworth.com.

Upholstered Gel Insert Seat	Adjustments	Number	①	Fabric Grade								Leather Grade A	Leather Grade B
				A	B	C	D	E	F	G	H		
No Lumbar Adjustment - Mesh Back w/Plastic Base													
	Pneumatic	SZT-20-002EA		\$1016.31	\$1050.72	\$1087.43	\$1105.80	\$1119.56	\$1152.84	\$1182.66	\$1264.12	\$1320.33	\$1469.75
	Back Stop	SZT-20-001EA		1093.17	1127.58	1164.29	1182.66	1196.42	1229.70	1259.52	1340.98	1397.19	1546.61
	Forward Tilt	SZT-20-003EA		1093.17	1127.58	1164.29	1182.66	1196.42	1229.70	1259.52	1340.98	1397.19	1546.61
	Back Stop/ Forward Tilt	SZT-20-004EA		1117.27	1151.68	1188.39	1206.76	1220.52	1253.80	1283.62	1365.08	1421.29	1570.71
No Lumbar Adjustment - Upholstered Back Jacket w/Plastic Base													
	Pneumatic	SZT-22-002EA		\$1129.89	\$1198.71	\$1272.13	\$1308.87	\$1336.39	\$1402.95	\$1462.59	\$1625.51	\$1737.93	\$2036.77
	Back Stop	SZT-22-001EA		1206.75	1275.57	1348.99	1385.73	1413.25	1479.81	1539.45	1702.37	1814.79	2113.63
	Forward Tilt	SZT-22-003EA		1206.75	1275.57	1348.99	1385.73	1413.25	1479.81	1539.45	1702.37	1814.79	2113.63
	Back Stop/ Forward Tilt	SZT-22-004EA		1230.85	1299.67	1373.09	1409.83	1437.35	1503.91	1563.55	1726.47	1838.89	2137.73
Lumbar Adjustment - Mesh Back w/Plastic Base													
	Pneumatic	SZT-20-012EA		\$1117.27	\$1151.68	\$1188.39	\$1206.76	\$1220.52	\$1253.80	\$1283.62	\$1365.08	\$1421.29	\$1570.71
	Back Stop	SZT-20-011EA		1194.13	1228.54	1265.25	1283.62	1297.38	1330.66	1360.48	1441.94	1498.15	1647.57
	Forward Tilt	SZT-20-013EA		1194.13	1228.54	1265.25	1283.62	1297.38	1330.66	1360.48	1441.94	1498.15	1647.57
	Back Stop/ Forward Tilt	SZT-20-014EA		1218.23	1252.64	1289.35	1307.72	1321.48	1354.76	1384.58	1466.04	1522.25	1671.67
Lumbar Adjustment - Upholstered Back Jacket w/Plastic Base													
	Pneumatic	SZT-22-012EA		\$1230.85	\$1299.67	\$1373.09	\$1409.83	\$1437.35	\$1503.91	\$1563.55	\$1726.47	\$1838.89	\$2137.73
	Back Stop	SZT-22-011EA		1307.71	1376.53	1449.95	1486.69	1514.21	1580.77	1640.41	1803.33	1915.75	2214.59
	Forward Tilt	SZT-22-013EA		1307.71	1376.53	1449.95	1486.69	1514.21	1580.77	1640.41	1803.33	1915.75	2214.59
	Back Stop/ Forward Tilt	SZT-22-014EA		1331.81	1400.63	1474.05	1510.79	1538.31	1604.87	1664.51	1827.43	1939.85	2238.69
PAL Back System - Mesh Back w/Plastic Base													
	Pneumatic	SZT-20-022EA		\$1143.66	\$1178.07	\$1214.78	\$1233.15	\$1246.91	\$1280.19	\$1310.01	\$1391.47	\$1447.68	\$1597.10
	Back Stop	SZT-20-021EA		1220.52	1254.93	1291.64	1310.01	1323.77	1357.05	1386.87	1468.33	1524.54	1673.96
	Forward Tilt	SZT-20-023EA		1220.52	1254.93	1291.64	1310.01	1323.77	1357.05	1386.87	1468.33	1524.54	1673.96
	Back Stop/ Forward Tilt	SZT-20-024EA		1244.62	1279.03	1315.74	1334.11	1347.87	1381.15	1410.97	1492.43	1548.64	1698.06
PAL Back System - Upholstered Back Jacket w/Plastic Base													
	Pneumatic	SZT-22-022EA		\$1257.24	\$1326.06	\$1399.48	\$1436.22	\$1463.74	\$1530.30	\$1589.94	\$1752.86	\$1865.28	\$2164.12
	Back Stop	SZT-22-021EA		1334.10	1402.92	1476.34	1513.08	1540.60	1607.16	1666.80	1829.72	1942.14	2240.98
	Forward Tilt	SZT-22-023EA		1334.10	1402.92	1476.34	1513.08	1540.60	1607.16	1666.80	1829.72	1942.14	2240.98
	Back Stop/ Forward Tilt	SZT-22-024EA		1358.20	1427.02	1500.44	1537.18	1564.70	1631.26	1690.90	1853.82	1966.24	2265.08

The following options require modification of the product number.

- Soft Casters
- Aluminum Base
- Low position pneumatic

- Fixed seat
- Headrest
- Stain repellent
- Leather Seat with Mesh Back
- Leather Seat with Leather Upholstered Back Jacket
- Faux Leather Seat with Mesh Back
- Faux Leather Seat with Faux Leather Upholstered Back Jacket

To specify, change the 11th digit from a 1 (hard caster) to a 2 (soft caster); **Example:** SZT-20-002EA2

To specify, change the 11th digit from a 5 to a 1 (hard caster) or 2 (soft caster) and add **\$32.78** list

To specify, change the 11th digit from a 1 to a 3 (hard caster) or from a 2 to a 4 (soft caster);

Examples: SZT-20-002EA3 is a low base with hard casters

SZT-20-002EA4 is a low base with soft casters

NOTE: Polished aluminum trim not available with this option.

To specify, change the 10th digit from A to X; **Example:** SZT-20-002EX1

To specify, change the 3rd digit from a T to an E; **Example:** SZE-22-002EA1 with headrest (add **\$59.65** list)

To specify, add **P** to end of the product number (add **\$35.57** list)

To specify, change the 4th digit to 1 and 5th digit to 0; **Example:** SZT-10-002EA5

To specify, change the 4th digit to 1 and 5th digit to 1; **Example:** SZT-11-002EA5

To specify, change the 4th digit to 3; **Example:** SZT-30-002EA5

To specify, change the 4th and 5th digits to 33; **Example:** SZT-33-002EA5

NOTE: For available fabrics, refer to surfaces.haworth.com.

Zody

Task Stool with 4D Arms



SZTC-20-702MA1

Dimensions*

- *SH: 21.5-29"
(546mm-737mm)
- H: 43-51"(1092mm-1295mm)
- D: 29"(737mm)
- W: 29"(737mm)
- *SW: 19 1/4"(489mm)
- *AH: 6.8-10.8"
(173mm-274mm)
- *SD: 16-19"(406mm-483mm)

* All measurements taken with the BIFMA chair measuring device.

Trim Color	Arm Cap Color*	
	Black	Smoke
Black (TR-F)	•	
Rusty Red (TR-RR)	•	
Sable (TR-1M)	•	
Smoke (TR-E)		•
Snow (TR-UFM)		•

*Not specifiable.

Features

- Back: Soft mesh only or mesh back with upholstered back jacket.
- Seat: Standard upholstered with foam or optional foam with Technogel® Soft Lite gel insert.
- Seat Type: Standard adjustable [3"(76mm) range] or optional fixed.
- Base: Standard Plastic painted five-star base or optional painted aluminum or polished aluminum.
 - Plastic base available in Black.
 - Aluminum base available with painted Black, Rusty Red, Snow, Metallic Silver, Metallic Champagne, Metallic Gunmetal, or optional Polished Aluminum.
- Arms: 4D with soft arm caps. See matrix for default colors.
- Mechanism: Balanced 3-point tilt; standard tilt tension.
- Height adjustment: Pneumatic.
- Optional Back Stop: Tilt stop in 6 positions.
- Optional Asymmetrical Lumbar Adjustment: 4"(102mm) height adjustment; support level can be adjusted independently for right or left hand side of users body. Optional PAL Back System: Passive pelvic support.
- Casters: Standard with hard casters; optional soft casters.
- COM yardage / COL square footage:
 - Mesh back model: .75/10
 - Mesh back/upholstered back jacket: 1.5/18

NOTE: When specifying fabric or leather back jacket; must also specify mesh surface color for outside back.

Upcharge for mixed grade surfaces, refer to the electronic design and specification tools.

To Order with Fabric or Leather Upholstered Back Jacket Specify:

1) Product number, including:

1 Base/Caster Option:

Aluminum Base

- 1 Aluminum Base, Hard Caster, add **\$32.78** to list
- 2 Aluminum Base, Soft Caster, add **\$32.78** to list

Plastic Base

- 5 Plastic Std. Base, Hard Caster
- 6 Plastic Std. Base, Soft Caster

- 2) Fabric surface and color (seat).
- 3) Mesh surface color (back).
- 4) Fabric surface and color (back jacket).
- 5) Trim color for frame. (Add **\$56.10** list for Snow.)
- 6) Trim color for base/arms. (Add **\$191.59** list for polished aluminum.)

To Order with Mesh Back Specify:

1) Product number, including:

1 Base/Caster Option:

Aluminum Base

- 1 Aluminum Base, Hard Caster, add **\$32.78** to list
- 2 Aluminum Base, Soft Caster, add **\$32.78** to list

Plastic Base

- 5 Plastic Std. Base, Hard Caster
- 6 Plastic Std. Base, Soft Caster

- 2) Fabric surface and color (seat).
- 3) Mesh surface and color (back).
- 4) Trim color for frame. (Add **\$56.10** list for Snow.)
- 5) Trim color for base/arms. (Add **\$191.59** list for polished aluminum.)

Zody

Task Stool with 4D Arms

Upholstered Foam Seat	Adjustments	Number	Fabric Grade								Leather Grade A	Leather Grade B
			A	B	C	D	E	F	G	H		
No Lumbar Adjustment - Mesh Back w/Plastic Base												
	Pneumatic	SZTC-20-702MA	\$1417.58	\$1451.99	\$1488.70	\$1507.07	\$1520.83	\$1554.11	\$1583.93	\$1665.39	\$1721.60	\$1871.02
	Back Stop	SZTC-20-701MA	1494.44	1528.85	1565.56	1583.93	1597.69	1630.97	1660.79	1742.25	1798.46	1947.88
No Lumbar Adjustment - Upholstered Back Jacket w/Plastic Base												
	Pneumatic	SZTC-22-702MA	\$1531.16	\$1599.98	\$1673.40	\$1710.14	\$1737.66	\$1804.22	\$1863.86	\$2026.78	\$2139.20	\$2438.04
	Back Stop	SZTC-22-701MA	1608.02	1676.84	1750.26	1787.00	1814.52	1881.08	1940.72	2103.64	2216.06	2514.90
Lumbar Adjustment - Mesh Back w/Plastic Base												
	Pneumatic	SZTC-20-712MA	\$1518.54	\$1552.95	\$1589.66	\$1608.03	\$1621.79	\$1655.07	\$1684.89	\$1766.35	\$1822.56	\$1971.98
	Back Stop	SZTC-20-711MA	1595.40	1629.81	1666.52	1684.89	1698.65	1731.93	1761.75	1843.21	1899.42	2048.84
Lumbar Adjustment - Upholstered Back Jacket w/Plastic Base												
	Pneumatic	SZTC-22-712MA	\$1632.12	\$1700.94	\$1774.36	\$1811.10	\$1838.62	\$1905.18	\$1964.82	\$2127.74	\$2240.16	\$2539.00
	Back Stop	SZTC-22-711MA	1708.98	1777.80	1851.22	1887.96	1915.48	1982.04	2041.68	2204.60	2317.02	2615.86
PAL Back System - Mesh Back w/Plastic Base												
	Pneumatic	SZTC-20-722MA	\$1544.93	\$1579.34	\$1616.05	\$1634.42	\$1648.18	\$1681.46	\$1711.28	\$1792.74	\$1848.95	\$1998.37
	Back Stop	SZTC-20-721MA	1621.79	1656.20	1692.91	1711.28	1725.04	1758.32	1788.14	1869.60	1925.81	2075.23
PAL Back System - Upholstered Back Jacket w/Plastic Base												
	Pneumatic	SZTC-22-722MA	\$1658.51	\$1727.33	\$1800.75	\$1837.49	\$1865.01	\$1931.57	\$1991.21	\$2154.13	\$2266.55	\$2565.39
	Back Stop	SZTC-22-721MA	1735.37	1804.19	1877.61	1914.35	1941.87	2008.43	2068.07	2230.99	2343.41	2642.25

The following options require modification of the product number.

- Fixed seat
- Stain repellent
- Leather Seat with Mesh Back
- Leather Seat with Leather Upholstered Back Jacket
- Faux Leather Seat with Mesh Back
- Faux Leather Seat with Faux Leather Upholstered Back Jacket

- To specify, change the 11th digit from A to X; **Example:** SZTC-20-702MX1
- To specify, add P to end of the product number (add \$35.57 list); **Example:** SZTC-20-712MA1P
- To specify, change the 5th digit to 1 and 6th digit to 0; **Example:** SZTC-10-702MA5
- To specify, change the 5th digit to 1 and 6th digit to 1; **Example:** SZTC-11-702MA5
- To specify, change the 5th digit to 3; **Example:** SZTC-30-702MA5
- To specify, change the 5th and 6th digits to 33; **Example:** SZTC-33-702MA5

NOTE: For available fabrics, refer to surfaces.haworth.com.

Zody

Task Stool with 4D Arms

Upholstered Gel Insert Seat	Adjustments	Number	①	Fabric Grade								Leather Grade A	Leather Grade B
				A	B	C	D	E	F	G	H		
No Lumbar Adjustment - Mesh Back w/Plastic Base													
Pneumatic		SZTC-20-702EA		\$1512.81	\$1547.22	\$1583.93	\$1602.30	\$1616.06	\$1649.34	\$1679.16	\$1760.62	\$1816.83	\$1966.25
Back Stop		SZTC-20-701EA		1589.67	1624.08	1660.79	1679.16	1692.92	1726.20	1756.02	1837.48	1893.69	2043.11
No Lumbar Adjustment - Upholstered Back Jacket w/Plastic Base													
Pneumatic		SZTC-22-702EA		\$1626.39	\$1695.21	\$1768.63	\$1805.37	\$1832.89	\$1899.45	\$1959.09	\$2122.01	\$2234.43	\$2533.27
Back Stop		SZTC-22-701EA		1703.25	1772.07	1845.49	1882.23	1909.75	1976.31	2035.95	2198.87	2311.29	2610.13
Lumbar Adjustment - Mesh Back w/Plastic Base													
Pneumatic		SZTC-20-712EA		\$1613.77	\$1648.18	\$1684.89	\$1703.26	\$1717.02	\$1750.30	\$1780.12	\$1861.58	\$1917.79	\$2067.21
Back Stop		SZTC-20-711EA		1690.63	1725.04	1761.75	1780.12	1793.88	1827.16	1856.98	1938.44	1994.65	2144.07
Lumbar Adjustment - Upholstered Back Jacket w/Plastic Base													
Pneumatic		SZTC-22-712EA		\$1727.35	\$1796.17	\$1869.59	\$1906.33	\$1933.85	\$2000.41	\$2060.05	\$2222.97	\$2335.39	\$2634.23
Back Stop		SZTC-22-711EA		1804.21	1873.03	1946.45	1983.19	2010.71	2077.27	2136.91	2299.83	2412.25	2711.09
PAL Back System - Mesh Back w/Plastic Base													
Pneumatic		SZTC-20-722EA		\$1640.16	\$1674.57	\$1711.28	\$1729.65	\$1743.41	\$1776.69	\$1806.51	\$1887.97	\$1944.18	\$2093.60
Back Stop		SZTC-20-721EA		1717.02	1751.43	1788.14	1806.51	1820.27	1853.55	1883.37	1964.83	2021.04	2170.46
PAL Back System - Upholstered Back Jacket w/Plastic Base													
Pneumatic		SZTC-22-722EA		\$1753.74	\$1822.56	\$1895.98	\$1932.72	\$1960.24	\$2026.80	\$2086.44	\$2249.36	\$2361.78	\$2660.62
Back Stop		SZTC-22-721EA		1830.60	1899.42	1972.84	2009.58	2037.10	2103.66	2163.30	2326.22	2438.64	2737.48

The following options require modification of the product number.

Fixed seat

Stain repellent

Leather Seat with Mesh Back

Leather Seat with Leather Upholstered Back Jacket

Faux Leather Seat with Mesh Back

Faux Leather Seat with Faux Leather Upholstered Back Jacket

To specify, change the 11th digit from A to X; **Example:** SZTC-20-702EX1

To specify, add **P** to end of the product number (add \$35.57 list); **Example:** SZTC-20-702EA1P

To specify, change the 5th digit to 1 and 6th digit to 0; **Example:** SZTC-10-702EA5

To specify, change the 5th digit to 1 and 6th digit to 1; **Example:** SZTC-11-702EA5

To specify, change the 5th digit to 3; **Example:** SZTC-30-702EA5

To specify, change the 5th and 6th digits to 33; **Example:** SZTC-33-702EA5

NOTE: For available fabrics, refer to surfaces.haworth.com.

This page intentionally blank

Zody

Task Stool with Height Adjustable Arms



SZTC-20-402MA1

Dimensions*

- *SH: 21.5-29"
(546mm-737mm)
- H: 43-51"(1092mm-1295mm)
- D: 29"(737mm)
- W: 29"(737mm)
- *SW: 19 1/4"(489mm)
- *AH: 6.8-10.8"
(173mm-274mm)
- *SD: 16-19"(406mm-483mm)

* All measurements taken with the BIFMA chair measuring device.

Trim Color	Arm Cap Color*	
	Black	Smoke
Black (TR-F)	•	
Rusty Red (TR-RR)	•	
Sable (TR-1M)	•	
Smoke (TR-E)		•
Snow (TR-UFM)		•

*Not specifiable.

Features

- Back: Soft mesh only or mesh back with upholstered back jacket.
- Seat: Standard upholstered with foam or optional foam with Technogel® Soft Lite gel insert.
- Seat Type: Standard adjustable [3"(76mm) range] or optional fixed.
- Base: Standard Plastic painted five-star base or optional painted aluminum or polished aluminum.
 - Plastic base available in Black.
 - Aluminum base available with painted Black, Rusty Red, Snow, Metallic Silver, Metallic Champagne, Metallic Gunmetal, or optional Polished Aluminum.
- Arms: Height-adjustable with soft arm caps. See matrix for default colors.
- Mechanism: Balanced 3-point tilt; standard tilt tension.
- Height adjustment: Pneumatic.
- Optional Back Stop: Tilt stop in 6 positions.
- Optional Asymmetrical Lumbar Adjustment: 4"(102mm) height adjustment; support level can be adjusted independently for right or left hand side of users body. Optional PAL Back System: Passive pelvic support.
- Casters: Standard with hard casters; optional soft casters.
- COM yardage / COL square footage:
 - Mesh back model: 0.75/10
 - Mesh back/upholstered back jacket: 1.5/18

NOTE: When specifying fabric or leather back jacket; must also specify mesh surface color for outside back.

Upcharge for mixed grade surfaces, refer to the electronic design and specification tools.

To Order with Fabric or Leather Upholstered Back Jacket Specify:

1) Product number, including:

1 Base/Caster Option:

Aluminum Base

- 1 Aluminum Base, Hard Caster, add **\$32.78** to list
- 2 Aluminum Base, Soft Caster, add **\$32.78** to list

Plastic Base

- 5 Plastic Std. Base, Hard Caster
- 6 Plastic Std. Base, Soft Caster

- 2) Fabric surface and color (seat).
- 3) Mesh surface color (back).
- 4) Fabric surface and color (back jacket).
- 5) Trim color for frame. (Add **\$56.10** list for Snow.)
- 6) Trim color for base/arms. (Add **\$191.59** list for polished aluminum.)

To Order with Mesh Back Specify:

1) Product number, including:

1 Base/Caster Option:

Aluminum Base

- 1 Aluminum Base, Hard Caster, add **\$32.78** to list
- 2 Aluminum Base, Soft Caster, add **\$32.78** to list

Plastic Base

- 5 Plastic Std. Base, Hard Caster
- 6 Plastic Std. Base, Soft Caster

- 2) Fabric surface and color (seat).
- 3) Mesh surface and color (back).
- 4) Trim color for frame. (Add **\$56.10** list for Snow.)
- 5) Trim color for base/arms. (Add **\$191.59** list for polished aluminum.)

Zody

Task Stool with Height Adjustable Arms

Upholstered Foam Seat	Adjustments	Number	①	Fabric Grade								Leather Grade A	Leather Grade B
				A	B	C	D	E	F	G	H		
No Lumbar Adjustment - Mesh w/Plastic Base													
	Pneumatic	SZTC-20-402MA		\$1379.72	\$1414.13	\$1450.84	\$1469.21	\$1482.97	\$1516.25	\$1546.07	\$1627.53	\$1683.74	\$1833.16
	Back Stop	SZTC-20-401MA		1456.58	1490.99	1527.70	1546.07	1559.83	1593.11	1622.93	1704.39	1760.60	1910.02
No Lumbar Adjustment - Upholstered Back Jacket w/Plastic Base													
	Pneumatic	SZTC-22-402MA		\$1493.30	\$1562.12	\$1635.54	\$1672.28	\$1699.80	\$1766.36	\$1826.00	\$1988.92	\$2101.34	\$2400.18
	Back Stop	SZTC-22-401MA		1570.16	1638.98	1712.40	1749.14	1776.66	1843.22	1902.86	2065.78	2178.20	2477.04
Lumbar Adjustment - Mesh w/Plastic Base													
	Pneumatic	SZTC-20-412MA		\$1480.68	\$1515.09	\$1551.80	\$1570.17	\$1583.93	\$1617.21	\$1647.03	\$1728.49	\$1784.70	\$1934.12
	Back Stop	SZTC-20-411MA		1557.54	1591.95	1628.66	1647.03	1660.79	1694.07	1723.89	1805.35	1861.56	2010.98
Lumbar Adjustment - Upholstered Back Jacket w/Plastic Base													
	Pneumatic	SZTC-22-412MA		\$1594.26	\$1663.08	\$1736.50	\$1773.24	\$1800.76	\$1867.32	\$1926.96	\$2089.88	\$2202.30	\$2501.14
	Back Stop	SZTC-22-411MA		1671.12	1739.94	1813.36	1850.10	1877.62	1944.18	2003.82	2166.74	2279.16	2578.00
PAL Back System - Mesh w/Plastic Base													
	Pneumatic	SZTC-20-422MA		\$1507.07	\$1541.48	\$1578.19	\$1596.56	\$1610.32	\$1643.60	\$1673.42	\$1754.88	\$1811.09	\$1960.51
	Back Stop	SZTC-20-421MA		1583.93	1618.34	1655.05	1673.42	1687.18	1720.46	1750.28	1831.74	1887.95	2037.37
PAL Back System - Upholstered Back Jacket w/Plastic Base													
	Pneumatic	SZTC-22-422MA		\$1620.65	\$1689.47	\$1762.89	\$1799.63	\$1827.15	\$1893.71	\$1953.35	\$2116.27	\$2228.69	\$2527.53
	Back Stop	SZTC-22-421MA		1697.51	1766.33	1839.75	1876.49	1904.01	1970.57	2030.21	2193.13	2305.55	2604.39

The following options require modification of the product number.

- Fixed seat
- Stain repellent
- Leather Seat with Mesh Back
- Leather Seat with Leather Upholstered Back Jacket
- Faux Leather Seat with Mesh Back
- Faux Leather Seat with Faux Leather Upholstered Back Jacket

- To specify, change the 11th digit from A to X; **Example:** SZTC-20-402MX1
- To specify, add **P** to end of the product number (add **\$35.57** list); **Example:** SZTC-20-401MAP
- To specify, change the 5th digit to **1** and 6th digit to **0**; **Example:** SZTC-10-402MA5
- To specify, change the 5th digit to **1** and 6th digit to **1**; **Example:** SZTC-11-402MA5
- To specify, change the 5th digit to **3**; **Example:** SZTC-30-402MA5
- To specify, change the 5th and 6th digits to **33**; **Example:** SZTC-33-402MA5

NOTE: For available fabrics, refer to surfaces.haworth.com.

Zody

Task Stool with Height Adjustable Arms

Upholstered Gel Insert Seat	Adjustments	Number	①	Fabric Grade								Leather Grade A	Leather Grade B
				A	B	C	D	E	F	G	H		
No Lumbar Adjustment - Mesh w/Plastic Base													
	Pneumatic	SZTC-20-402EA		\$1474.95	\$1509.36	\$1546.07	\$1564.44	\$1578.20	\$1611.48	\$1641.30	\$1722.76	\$1778.97	\$1928.39
	Back Stop	SZTC-20-401EA		1551.81	1586.22	1622.93	1641.30	1655.06	1688.34	1718.16	1799.62	1855.83	2005.25
No Lumbar Adjustment - Upholstered Back Jacket w/Plastic Base													
	Pneumatic	SZTC-22-402EA		\$1588.53	\$1657.35	\$1730.77	\$1767.51	\$1795.03	\$1861.59	\$1921.23	\$2084.15	\$2196.57	\$2495.41
	Back Stop	SZTC-22-401EA		1665.39	1734.21	1807.63	1844.37	1871.89	1938.45	1998.09	2161.01	2273.43	2572.27
Lumbar Adjustment - Mesh w/Plastic Base													
	Pneumatic	SZTC-20-412EA		\$1575.91	\$1610.32	\$1647.03	\$1665.40	\$1679.16	\$1712.44	\$1742.26	\$1823.72	\$1879.93	\$2029.35
	Back Stop	SZTC-20-411EA		1652.77	1687.18	1723.89	1742.26	1756.02	1789.30	1819.12	1900.58	1956.79	2106.21
Lumbar Adjustment - Upholstered Back Jacket w/Plastic Base													
	Pneumatic	SZTC-22-412EA		\$1689.49	\$1758.31	\$1831.73	\$1868.47	\$1895.99	\$1962.55	\$2022.19	\$2185.11	\$2297.53	\$2596.37
	Back Stop	SZTC-22-411EA		1766.35	1835.17	1908.59	1945.33	1972.85	2039.41	2099.05	2261.97	2374.39	2673.23
PAL Back System - Mesh w/Plastic Base													
	Pneumatic	SZTC-20-422EA		\$1602.30	\$1636.71	\$1673.42	\$1691.79	\$1705.55	\$1738.83	\$1768.65	\$1850.11	\$1906.32	\$2055.74
	Back Stop	SZTC-20-421EA		1679.16	1713.57	1750.28	1768.65	1782.41	1815.69	1845.51	1926.97	1983.18	2132.60
PAL Back System - Upholstered Back Jacket w/Plastic Base													
	Pneumatic	SZTC-22-422EA		\$1715.88	\$1784.70	\$1858.12	\$1894.86	\$1922.38	\$1988.94	\$2048.58	\$2211.50	\$2323.92	\$2622.76
	Back Stop	SZTC-22-421EA		1792.74	1861.56	1934.98	1971.72	1999.24	2065.80	2125.44	2288.36	2400.78	2699.62

The following options require modification of the product number.

- Fixed seat
- Stain repellent
- Leather Seat with Mesh Back
- Leather Seat with Leather Upholstered Back Jacket
- Faux Leather Seat with Mesh Back
- Faux Leather Seat with Faux Leather Upholstered Back Jacket

- To specify, change the 11th digit from A to X; **Example:** SZTC-20-402EX1
- To specify, add **P** to end of the product number (add **\$35.57** list); **Example:** SZTC-20-422EA1P
- To specify, change the 5th digit to **1** and 6th digit to **0**; **Example:** SZTC-10-402EA5
- To specify, change the 5th digit to **1** and 6th digit to **1**; **Example:** SZTC-11-402EA5
- To specify, change the 5th digit to **3**; **Example:** SZTC-30-402EA5
- To specify, change the 5th and 6th digits to **33**; **Example:** SZTC-33-402EA5

NOTE: For available fabrics, refer to surfaces.haworth.com.

This page intentionally blank

Zody

Task Stool with Fixed Arms



SZTC-20-102MA1

Dimensions*

- *SH: 21.5-29"
(546mm-737mm)
- H: 43-51"(1092mm-1295mm)
- D: 29"(737mm)
- W: 29"(737mm)
- *SW: 19 1/4"(489mm)
- *AH: 9"(229mm)
- *SD: 16-19"(406mm-483mm)

* All measurements taken with the BIFMA chair measuring device.

Features

- Back: Soft mesh only or mesh back with upholstered back jacket.
- Seat: Standard upholstered with foam or optional foam with Technogel® Soft Lite gel insert.
- Seat Type: Standard adjustable [3"(76mm) range] or optional fixed.
- Base: Standard Plastic painted five-star base or optional painted aluminum or polished aluminum. –Plastic base available in Black. –Aluminum base available with painted Black, Rusty Red, Snow, Metallic Silver, Metallic Champagne, Metallic Gunmetal, or optional Polished Aluminum.
- Arms: Fixed with soft arm caps. See matrix for default colors.
- Mechanism: Balanced 3-point tilt; standard tilt tension.
- Height adjustment: Pneumatic.
- Optional Back Stop: Tilt stop in 6 positions.
- Optional Asymmetrical Lumbar Adjustment: 4"(102mm) height adjustment; support level can be adjusted independently for right or left hand side of users body. Optional PAL Back System: Passive pelvic support.
- Casters: Standard with hard casters; optional soft casters.
- COM yardage / COL square footage:
Mesh back model: 0.75/10
Mesh back/upholstered back jacket: 1.5/18

NOTE: When specifying fabric or leather back jacket; must also specify mesh surface color for outside back.

Upcharge for mixed grade surfaces, refer to the electronic design and specification tools.

Trim Color	Arm Cap Color*	
	Black	Smoke
Black (TR-F)	•	
Rusty Red (TR-RR)	•	
Sable (TR-1M)	•	
Smoke (TR-E)		•
Snow (TR-UFM)		•

*Not specifiable.

To Order with Fabric or Leather Upholstered Back Jacket Specify:

1) Product number, including:

1 Base/Caster Option:

Aluminum Base

- 1 Aluminum Base, Hard Caster, add **\$32.78** to list
- 2 Aluminum Base, Soft Caster, add **\$32.78** to list

Plastic Base

- 5 Plastic Std. Base, Hard Caster
- 6 Plastic Std. Base, Soft Caster

- 2) Fabric surface and color (seat).
- 3) Mesh surface color (back).
- 4) Fabric surface and color (back jacket).
- 5) Trim color for frame. (Add **\$56.10** list for Snow.)
- 6) Trim color for base/arms. (Add **\$191.59** list for polished aluminum.)

To Order with Mesh Back Specify:

1) Product number, including:

1 Base/Caster Option:

Aluminum Base

- 1 Aluminum Base, Hard Caster, add **\$32.78** to list
- 2 Aluminum Base, Soft Caster, add **\$32.78** to list

Plastic Base

- 5 Plastic Std. Base, Hard Caster
- 6 Plastic Std. Base, Soft Caster

- 2) Fabric surface and color (seat).
- 3) Mesh surface and color (back).
- 4) Trim color for frame. (Add **\$56.10** list for Snow.)
- 5) Trim color for base/arms. (Add **\$191.59** list for polished aluminum.)

Zody

Task Stool with Fixed Arms

Upholstered Foam Seat	Adjustments	Number	Fabric Grade								Leather Grade A	Leather Grade B
			A	B	C	D	E	F	G	H		
No Lumbar Adjustment - Mesh Back w/Plastic Base												
Pneumatic		SZTC-20-102MA	\$1301.71	\$1336.12	\$1372.83	\$1391.20	\$1404.96	\$1438.24	\$1468.06	\$1549.52	\$1605.73	\$1755.15
Back Stop		SZTC-20-101MA	1378.57	1412.98	1449.69	1468.06	1481.82	1515.10	1544.92	1626.38	1682.59	1832.01
No Lumbar Adjustment - Upholstered Back Jacket w/Plastic Base												
Pneumatic		SZTC-22-102MA	\$1415.29	\$1484.11	\$1557.53	\$1594.27	\$1621.79	\$1688.35	\$1747.99	\$1910.91	\$2023.33	\$2322.17
Back Stop		SZTC-22-101MA	1492.15	1560.97	1634.39	1671.13	1698.65	1765.21	1824.85	1987.77	2100.19	2399.03
Lumbar Adjustment - Mesh Back w/Plastic Base												
Pneumatic		SZTC-20-112MA	\$1402.67	\$1437.08	\$1473.79	\$1492.16	\$1505.92	\$1539.20	\$1569.02	\$1650.48	\$1706.69	\$1856.11
Back Stop		SZTC-20-111MA	1479.53	1513.94	1550.65	1569.02	1582.78	1616.06	1645.88	1727.34	1783.55	1932.97
Lumbar Adjustment - Upholstered Back Jacket w/Plastic Base												
Pneumatic		SZTC-22-112MA	\$1516.25	\$1585.07	\$1658.49	\$1695.23	\$1722.75	\$1789.31	\$1848.95	\$2011.87	\$2124.29	\$2423.13
Back Stop		SZTC-22-111MA	1593.11	1661.93	1735.35	1772.09	1799.61	1866.17	1925.81	2088.73	2201.15	2499.99
PAL Back System - Mesh Back w/Plastic Base												
Pneumatic		SZTC-20-122MA	\$1429.06	\$1463.47	\$1500.18	\$1518.55	\$1532.31	\$1565.59	\$1595.41	\$1676.87	\$1733.08	\$1882.50
Back Stop		SZTC-20-121MA	1505.92	1540.33	1577.04	1595.41	1609.17	1642.45	1672.27	1753.73	1809.94	1959.36
PAL Back System - Upholstered Back Jacket w/Plastic Base												
Pneumatic		SZTC-22-122MA	\$1542.64	\$1611.46	\$1684.88	\$1721.62	\$1749.14	\$1815.70	\$1875.34	\$2038.26	\$2150.68	\$2449.52
Back Stop		SZTC-22-121MA	1619.50	1688.32	1761.74	1798.48	1826.00	1892.56	1952.20	2115.12	2227.54	2526.38

The following options require modification of the product number.

- Fixed seat
- Stain repellent
- Leather Seat with Mesh Back
- Leather Seat with Leather Upholstered Back Jacket
- Faux Leather Seat with Mesh Back
- Faux Leather Seat with Faux Leather Upholstered Back Jacket

- To specify, change the 11th digit from A to X; **Example:** SZTC-20-102MX1
- To specify, add **P** to end of the product number (add \$35.57 list); **Example:** SZTC-22-101MA1P
- To specify, change the 5th digit to 1 and 6th digit to 0; **Example:** SZTC-10-102MA5
- To specify, change the 5th digit to 1 and 6th digit to 1; **Example:** SZTC-11-102MA5
- To specify, change the 5th digit to 3; **Example:** SZTC-30-102MA5
- To specify, change the 5th and 6th digits to 33; **Example:** SZTC-33-102MA5

NOTE: For available fabrics, refer to surfaces.haworth.com.

Zody

Task Stool with Fixed Arms

Upholstered Gel Insert Seat	Adjustments	Number	①	Fabric Grade								Leather Grade A	Leather Grade B
				A	B	C	D	E	F	G	H		
No Lumbar Adjustment - Mesh Back w/Plastic Base													
Pneumatic		SZTC-20-102EA		\$1396.94	\$1431.35	\$1468.06	\$1486.43	\$1500.19	\$1533.47	\$1563.29	\$1644.75	\$1700.96	\$1850.38
Back Stop		SZTC-20-101EA		1473.80	1508.21	1544.92	1563.29	1577.05	1610.33	1640.15	1721.61	1777.82	1927.24
No Lumbar Adjustment - Upholstered Back Jacket w/Plastic Base													
Pneumatic		SZTC-22-102EA		\$1510.52	\$1579.34	\$1652.76	\$1689.50	\$1717.02	\$1783.58	\$1843.22	\$2006.14	\$2118.56	\$2417.40
Back Stop		SZTC-22-101EA		1587.38	1656.20	1729.62	1766.36	1793.88	1860.44	1920.08	2083.00	2195.42	2494.26
Lumbar Adjustment - Mesh Back w/Plastic Base													
Pneumatic		SZTC-20-112EA		\$1497.90	\$1532.31	\$1569.02	\$1587.39	\$1601.15	\$1634.43	\$1664.25	\$1745.71	\$1801.92	\$1951.34
Back Stop		SZTC-20-111EA		1574.76	1609.17	1645.88	1664.25	1678.01	1711.29	1741.11	1822.57	1878.78	2028.20
Lumbar Adjustment - Upholstered Back Jacket w/Plastic Base													
Pneumatic		SZTC-22-112EA		\$1611.48	\$1680.30	\$1753.72	\$1790.46	\$1817.98	\$1884.54	\$1944.18	\$2107.10	\$2219.52	\$2518.36
Back Stop		SZTC-22-111EA		1688.34	1757.16	1830.58	1867.32	1894.84	1961.40	2021.04	2183.96	2296.38	2595.22
PAL Back System - Mesh Back w/Plastic Base													
Pneumatic		SZTC-20-122EA		\$1524.29	\$1558.70	\$1595.41	\$1613.78	\$1627.54	\$1660.82	\$1690.64	\$1772.10	\$1828.31	\$1977.73
Back Stop		SZTC-20-121EA		1601.15	1635.56	1672.27	1690.64	1704.40	1737.68	1767.50	1848.96	1905.17	2054.59
PAL Back System - Upholstered Back Jacket w/Plastic Base													
Pneumatic		SZTC-22-122EA		\$1637.87	\$1706.69	\$1780.11	\$1816.85	\$1844.37	\$1910.93	\$1970.57	\$2133.49	\$2245.91	\$2544.75
Back Stop		SZTC-22-121EA		1714.73	1783.55	1856.97	1893.71	1921.23	1987.79	2047.43	2210.35	2322.77	2621.61

The following options require modification of the product number.

- Fixed seat
- Stain repellent
- Leather Seat with Mesh Back
- Leather Seat with Leather Upholstered Back Jacket
- Faux Leather Seat with Mesh Back
- Faux Leather Seat with Faux Leather Upholstered Back Jacket

- To specify, change the 11th digit from A to X; **Example:** SZTC-20-102EX1
- To specify, add **P** to end of the product number (add **\$35.57** list); **Example:** SZTC-20-102EA1P
- To specify, change the 5th digit to **1** and 6th digit to **0**; **Example:** SZTC-10-102EA5
- To specify, change the 5th digit to **1** and 6th digit to **1**; **Example:** SZTC-11-102EA5
- To specify, change the 5th digit to **3**; **Example:** SZTC-30-102EA5
- To specify, change the 5th and 6th digits to **33**; **Example:** SZTC-33-102EA5

NOTE: For available fabrics, refer to surfaces.haworth.com.

This page intentionally blank

Zody

Task Stool without Arms



SZTC-20-002MA1

Dimensions*

- *SH: 21.5-29"
(546mm-737mm)
- H: 43-51"(1092mm-1295mm)
- D: 29"(737mm)
- W: 29"(737mm)
- *SW: 19 1/4"(489mm)
- *SD: 16-19"(406mm-483mm)

* All measurements taken with the BIFMA chair measuring device.

Features

- Back: Soft mesh only or mesh back with upholstered back jacket.
- Seat: Standard upholstered with foam or optional foam with Technogel® Soft Lite gel insert.
- Seat Type: Standard adjustable [3"(76mm) range] or optional fixed.
- Base: Standard Plastic painted five-star base or optional painted aluminum or polished aluminum.
 - Plastic base available in Black.
 - Aluminum base available with painted Black, Rusty Red, Snow, Metallic Silver, Metallic Champagne, Metallic Gunmetal, or optional Polished Aluminum.
- Mechanism: Balanced 3-point tilt; standard tilt tension.
- Height adjustment: Pneumatic.
- Optional Back Stop: Tilt stop in 6 positions.
- Optional Asymmetrical Lumbar Adjustment: 4"(102mm) height adjustment; support level can be adjusted independently for right or left hand side of users body. Optional PAL Back System: Passive pelvic support
- Casters: Standard with hard casters; optional soft casters.
- COM yardage / COL square footage:
 - Mesh back model: 0.75/10
 - Mesh back/upholstered back jacket: 1.5/18

NOTE: When specifying fabric or leather back jacket; must also specify mesh surface color for outside back.

Upcharge for mixed grade surfaces, refer to the electronic design and specification tools.

To Order with Fabric or Leather Upholstered Back Jacket Specify:

1) Product number, including:

1 Base/Caster Option:**Aluminum Base**

- 1** Aluminum Base, Hard Caster, add **\$32.78** to list
- 2** Aluminum Base, Soft Caster, add **\$32.78** to list

Plastic Base

- 5** Plastic Std. Base, Hard Caster
- 6** Plastic Std. Base, Soft Caster

- 2) Fabric surface and color (seat).
- 3) Mesh surface color (back).
- 4) Fabric surface and color (back jacket).
- 5) Trim color for frame. (Add **\$56.10** list for Snow.)
- 6) Trim color for base. (Add **\$191.59** list for polished aluminum.)

To Order with Mesh Back Specify:

1) Product number, including:

1 Base/Caster Option:**Aluminum Base**

- 1** Aluminum Base, Hard Caster, add **\$32.78** to list
- 2** Aluminum Base, Soft Caster, add **\$32.78** to list

Plastic Base

- 5** Plastic Std. Base, Hard Caster
- 6** Plastic Std. Base, Soft Caster

- 2) Fabric surface and color (seat).
- 3) Mesh surface and color (back).
- 4) Trim color for frame. (Add **\$56.10** list for Snow.)
- 5) Trim color for base. (Add **\$191.59** list for polished aluminum.)

Upholstered Foam Seat	Adjustments	Number	Fabric Grade								Leather Grade A	Leather Grade B
			A	B	C	D	E	F	G	H		
No Lumbar Adjustment - Mesh Back w/Plastic Base												
	Pneumatic	SZTC-20-002MA	\$1174.36	\$1208.77	\$1245.48	\$1263.85	\$1277.61	\$1310.89	\$1340.71	\$1422.17	\$1478.38	\$1627.80
	Back Stop	SZTC-20-001MA	1251.22	1285.63	1322.34	1340.71	1354.47	1387.75	1417.57	1499.03	1555.24	1704.66
No Lumbar Adjustment - Upholstered Back Jacket w/Plastic Base												
	Pneumatic	SZTC-22-002MA	\$1287.94	\$1356.76	\$1430.18	\$1466.92	\$1494.44	\$1561.00	\$1620.64	\$1783.56	\$1895.98	\$2194.82
	Back Stop	SZTC-22-001MA	1364.80	1433.62	1507.04	1543.78	1571.30	1637.86	1697.50	1860.42	1972.84	2271.68
Lumbar Adjustment - Mesh Back w/Plastic Base												
	Pneumatic	SZTC-20-012MA	\$1275.32	\$1309.73	\$1346.44	\$1364.81	\$1378.57	\$1411.85	\$1441.67	\$1523.13	\$1579.34	\$1728.76
	Back Stop	SZTC-20-011MA	1352.18	1386.59	1423.30	1441.67	1455.43	1488.71	1518.53	1599.99	1656.20	1805.62
Lumbar Adjustment - Upholstered Back Jacket w/Plastic Base												
	Pneumatic	SZTC-22-012MA	\$1388.90	\$1457.72	\$1531.14	\$1567.88	\$1595.40	\$1661.96	\$1721.60	\$1884.52	\$1996.94	\$2295.78
	Back Stop	SZTC-22-011MA	1465.76	1534.58	1608.00	1644.74	1672.26	1738.82	1798.46	1961.38	2073.80	2372.64
PAL Back System - Mesh Back w/Plastic Base												
	Pneumatic	SZTC-20-022MA	\$1301.71	\$1336.12	\$1372.83	\$1391.20	\$1404.96	\$1438.24	\$1468.06	\$1549.52	\$1605.73	\$1755.15
	Back Stop	SZTC-20-021MA	1378.57	1412.98	1449.69	1468.06	1481.82	1515.10	1544.92	1626.38	1682.59	1832.01
PAL Back System - Upholstered Back Jacket w/Plastic Base												
	Pneumatic	SZTC-22-022MA	\$1415.29	\$1484.11	\$1557.53	\$1594.27	\$1621.79	\$1688.35	\$1747.99	\$1910.91	\$2023.33	\$2322.17
	Back Stop	SZTC-22-021MA	1492.15	1560.97	1634.39	1671.13	1698.65	1765.21	1824.85	1987.77	2100.19	2399.03

The following options require modification of the product number.

- Fixed seat
- Stain repellent
- Leather Seat with Mesh Back
- Leather Seat with Leather Upholstered Back Jacket
- Faux Leather Seat with Mesh Back
- Faux Leather Seat with Faux Leather Upholstered Back Jacket

- To specify, change the 11th digit from A to X; **Example:** SZTC-20-002MX1
- To specify, add **P** to end of the product number (add \$35.57 list); **Example:** SZTC-20-002MA1P
- To specify, change the 5th digit to 1 and 6th digit to 0; **Example:** SZTC-10-002MA5
- To specify, change the 5th digit to 1 and 6th digit to 1; **Example:** SZTC-11-002MA5
- To specify, change the 5th digit to 3; **Example:** SZTC-30-002MA5
- To specify, change the 5th and 6th digits to 33; **Example:** SZTC-33-002MA5

NOTE: For available fabrics, refer to surfaces.haworth.com.

Zody

Task Stool without Arms

Upholstered Gel Insert Seat	Adjustments	Number	Fabric Grade								Leather Grade A	Leather Grade B
			A	B	C	D	E	F	G	H		
No Lumbar Adjustment - Mesh Back w/Plastic Base												
Pneumatic		SZTC-20-002EA	\$1269.59	\$1304.00	\$1340.71	\$1359.08	\$1372.84	\$1406.12	\$1435.94	\$1517.40	\$1573.61	\$1723.03
Back Stop		SZTC-20-001EA	1346.45	1380.86	1417.57	1435.94	1449.70	1482.98	1512.80	1594.26	1650.47	1799.89
No Lumbar Adjustment - Upholstered Back Jacket w/Plastic Base												
Pneumatic		SZTC-22-002EA	\$1383.17	\$1451.99	\$1525.41	\$1562.15	\$1589.67	\$1656.23	\$1715.87	\$1878.79	\$1991.21	\$2290.05
Back Stop		SZTC-22-001EA	1460.03	1528.85	1602.27	1639.01	1666.53	1733.09	1792.73	1955.65	2068.07	2366.91
Lumbar Adjustment - Mesh Back w/Plastic Base												
Pneumatic		SZTC-20-012EA	\$1370.55	\$1404.96	\$1441.67	\$1460.04	\$1473.80	\$1507.08	\$1536.90	\$1618.36	\$1674.57	\$1823.99
Back Stop		SZTC-20-011EA	1447.41	1481.82	1518.53	1536.90	1550.66	1583.94	1613.76	1695.22	1751.43	1900.85
Lumbar Adjustment - Upholstered Back Jacket w/Plastic Base												
Pneumatic		SZTC-22-012EA	\$1484.13	\$1552.95	\$1626.37	\$1663.11	\$1690.63	\$1757.19	\$1816.83	\$1979.75	\$2092.17	\$2391.01
Back Stop		SZTC-22-011EA	1560.99	1629.81	1703.23	1739.97	1767.49	1834.05	1893.69	2056.61	2169.03	2467.87
PAL Back System - Mesh Back w/Plastic Base												
Pneumatic		SZTC-20-022EA	\$1396.94	\$1431.35	\$1468.06	\$1486.43	\$1500.19	\$1533.47	\$1563.29	\$1644.75	\$1700.96	\$1850.38
Back Stop		SZTC-20-021EA	1473.80	1508.21	1544.92	1563.29	1577.05	1610.33	1640.15	1721.61	1777.82	1927.24
PAL Back System - Upholstered Back Jacket w/Plastic Base												
Pneumatic		SZTC-22-022EA	\$1510.52	\$1579.34	\$1652.76	\$1689.50	\$1717.02	\$1783.58	\$1843.22	\$2006.14	\$2118.56	\$2417.40
Back Stop		SZTC-22-021EA	1587.38	1656.20	1729.62	1766.36	1793.88	1860.44	1920.08	2083.00	2195.42	2494.26

The following options require modification of the product number.

- | | |
|---|--|
| Fixed seat | To specify, change the 11th digit from A to X; Example: SZTC-20-002EX1 |
| Stain repellent | To specify, add P to end of the product number (add \$35.57 list); Example: SZTC-20-002EA1P |
| Leather Seat with Mesh Back | To specify, change the 5th digit to 1 and 6th digit to 0 ; Example: SZTC-10-002EA5 |
| Leather Seat with Leather Upholstered Back Jacket | To specify, change the 5th digit to 1 and 6th digit to 1 ; Example: SZTC-11-002EA5 |
| Faux Leather Seat with Mesh Back | To specify, change the 5th digit to 3 ; Example: SZTC-30-002EA5 |
| Faux Leather Seat with Faux Leather Upholstered Back Jacket | To specify, change the 5th and 6th digits to 33 ; Example: SZTC-33-002EA5 |
- NOTE:** For available fabrics, refer to surfaces.haworth.com.

Zody

Sled Base



SZG-22-1

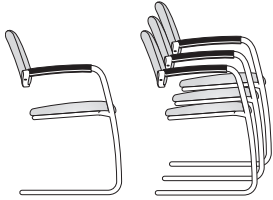

Dimensions*

- *SH: 18" (457mm)
- H: 32.5" (826mm)
- D: 22.1" (501mm)
- W: 21" (533mm)
- *SW: 16.8" (427mm)
- *SD: 17" (432mm)
- *AH: 26" (660mm)

* All measurements taken with the BIFMA chair measuring device.

Features

- Back: Upholstered or Wood (Beech)
Fully cantilevered
- Seat: Upholstered
- Base: Sled
- Glide options: Plastic (S) or Felt (J)
(Felt glides for use on hard floors. Glides are retrofittable. See e-Parts.)
- Felt glides are black color.
- Optional Trivalent chrome frame
- Stacking: 4-high
- COM Yardage / COL square footage
Back: 0.75/15.2
Seat: 0.75/15.2

To Order, Specify:

1) Product number, including:

1 Sled Base Glides:

- S** Plastic
- J** Felt

- 2) Seat surface and color
- 3) Back surface and color
- 4) Arm cap trim color
- 5) Base trim color
Trivalent chrome (KR-V)
add **\$191.59** list

Seat	Back	Number ①	Fabric Grade								Leather Grade A	Leather Grade B
			A	B	C	D	E	F	G	H		
Fabric	Fabric	SZG-22-1	\$784.73	\$848.99	\$922.41	\$959.11	\$986.65	\$1050.89	\$1110.53	\$1275.75	N/A	N/A
Fabric	Wood	SZG-2W-1	\$881.10	\$913.23	\$949.94	\$968.29	\$982.06	\$1014.18	\$1044.00	\$1126.61	N/A	N/A
Leather	Leather	SZG-11-1	N/A	N/A	N/A	N/A	N/A	N/A	N/A	N/A	\$1388.21	\$1685.05
Leather	Wood	SZG-1W-1	N/A	N/A	N/A	N/A	N/A	N/A	N/A	N/A	\$1182.84	\$1331.26

The following options require modification of the product number.

- CAL 133
- Stain repellent
- Moisture barrier with Stain Repellent
- Faux Leather Seat and Back
- Faux Leather Seat with Wood Back

- To specify, add **F** to the end of the product number; **Example:** SZG-22-1SF (add **\$52.77** list)
- To specify, add **P** to end of the product number (add **\$35.57** list)
- To specify, add **D** to end of the product number (add **\$48.18** list)
- To specify, change the 4th digit to **3** and 5th digit to **3**; **Example:** SZG-33-S
- To specify, change the 4th digit to **3** and 5th digit to **W**; **Example:** SZG-3W-J

NOTE: Upcharge for mixed grade surfaces, refer to the electronic design and specification tools.
For available fabrics, refer to surfaces.haworth.com.

Zody

4 Leg



SZG-22-1



Dimensions*

- *SH: 18" (457mm)
- H: 32.5" (826mm)
- D: 22.13" (562mm)
- W: 21" (533mm)
- *SW: 16.4" (417mm)
- *SD: 17" (432mm)
- *AH: 26" (660mm)

* All measurements taken with the BIFMA chair measuring device.

Features

- Back: Upholstered or Wood (Beech)
Fully cantilevered
- Seat: Upholstered
- Base: 4 Legs
- Optional Glide: Plastic (H) or Felt (K)
(Felt glides for use on hard floors. Glides are retrofittable. See e-Parts.)
- Felt glides are black color.
- Optional Trivalent chrome frame
- Stacking: 6-high
- COM Yardage / COL square footage
Back: 0.75/15.2
Seat: 0.75/15.2

To Order, Specify:

1) Product number, including:

1 Leg Base Glides:

- H** Plastic
- K** Felt

- 2) Seat surface and color
- 3) Back surface and color
- 4) Arm cap trim color
- 5) Base trim color
Trivalent chrome (KR-V)
add **\$191.59** list

Seat	Back	Number ①	Fabric Grade								Leather Grade A	Leather Grade B	
			A	B	C	D	E	F	G	H			
Fabric	Fabric	SZG-22-1	■	\$657.38	\$721.64	\$795.06	\$831.76	\$859.30	\$923.54	\$983.18	\$1148.40	N/A	N/A
Fabric	Wood	SZG-2W-1	■	\$753.75	\$785.88	\$822.59	\$840.94	\$854.71	\$886.83	\$916.65	\$ 999.26	N/A	N/A
Leather	Leather	SZG-11-1	■	N/A	N/A	N/A	N/A	N/A	N/A	N/A	N/A	\$1260.86	\$1557.70
Leather	Wood	SZG-1W-1	■	N/A	N/A	N/A	N/A	N/A	N/A	N/A	N/A	\$1055.49	\$1203.91

The following options require modification of the product number.

- CAL 133
- Stain repellent
- Moisture barrier with Stain Repellent
- Faux Leather Seat and Back
- Faux Leather Seat with Wood Back

- To specify, add **F** to the end of the product number; **Example:** SZG-22-1HF (add **\$52.77** list)
- To specify, add **P** to end of the product number (add **\$35.57** list)
- To specify, add **D** to end of the product number (add **\$48.18** list)
- To specify, change the 4th digit to **3** and 5th digit to **3**; **Example:** SZG-33-S
- To specify, change the 4th digit to **3** and 5th digit to **W**; **Example:** SZG-3W-J

NOTE: Upcharge for mixed grade surfaces, refer to the electronic design and specification tools.

For available fabrics, refer to surfaces.haworth.com.

Very Wire Stacker

General Specifications

Features and Options (Wire Stacker and Wire Stool)

Wire Stacker Chair

- 11mm solid steel rod frame
- Single piece high-strength polymer shell seat and back
- Clear nylon glides
- Frame finishes include: painted or Trivalent chrome
- Optional upholstered foam pad on seat or seat and back
- Fog or black trim arm caps
- Arm or armless version available
- Arm chair stacks 5-high on the floor or 15-high on a cart. Total height on cart is 54"(1372mm). Total depth 55"(1397mm). Height of front edge is 46.5"(1181mm).
- Armless stacks 10-high on the floor, upholstered or non-upholstered; stacks 40-high non-upholstered on a cart; stacks 25-high upholstered on a cart.
- Seat: Stitched double seams. Vertically in the center and on the edges of the leather seat cushion.
- Ganging option: arm chair to armless, armless to armless.
- Chairs with arms: 16 lbs.
- Chairs without arms: 15 lbs.

Wire Stacker Stool

- Chrome frame
- Stacks 5-high on the floor.
- Single piece high-strength polymer shell seat and back
- Clear nylon glides
- Fog or black trim arm caps
- Arm or armless version available

General Guidelines for Product Specification

	<u>S</u>	<u>C</u>	<u>H - 2</u>	<u>2 - 3</u>	<u>S</u>	<u>E</u>	<u>3A-18</u>	<u>3A-18</u>	<u>TR-FA</u>	<u>TR-F</u>	<u>KR-V</u>
Product Type	_____										
(S) Seating	_____										
Product Line	_____										
(C) Very	_____										
Model	_____										
(H) Wire Stack	_____										
(W) Stool	_____										
Seat Upholstery	_____										
(1) Leather	_____										
(2) Fabric	_____										
(3) Faux Leather	_____										
(4) Polymer	_____										
Back Upholstery	_____										
(1) Leather	_____										
(2) Fabric	_____										
(3) Faux Leather	_____										
(4) Polymer	_____										
Arm/Caps	_____										
(0) No Arms	_____										
(3) Fixed Arms, Hard Caps	_____										
Base Frame	_____										
(9) Plastic Glide, Ganging*	_____										
(S) Plastic Glide, Non-ganging*	_____										
Enhanced Upholstery	_____										
Seat Upholstery	_____										
Tellure	_____										
Back Upholstery	_____										
Tellure	_____										
Shell Color	_____										
Tomato	_____										
Trim Color	_____										
Black	_____										
Frame Trim Color	_____										
Trivalent Chrome	_____										

*Wire Stacker Chair only

Very

Wire Stacker

With Arms



SCH-44-35

Dimensions

SH: 17.3"(440mm)*
 H: 30.6"(778mm)
 D: 23.3"(591mm)
 W: 23"(584mm)
 SW: 18.8"(476mm)*
 SD: 17.3"(439mm)*
 AH: 8.5"(216mm)*
 Between Arms:
 19.2"(487mm)

* All measurements taken with the BIFMA chair measuring device.

Features

- 11 mm steel rod frame.
- Single high-strength polymer shell seat and back with an optional upholstery pad.
- Upholstered seat features 0.5"(12.7mm) foam pad.
- Upholstered back features 0.5"(12.7mm) foam pad.
- Arms: Black or Fog glass-filled polypropylene arm caps.
- Frame: Available painted or trivalent chrome.
- High impact clear nylon glides available with or without ganging option.
- Stacks 5-high on the floor or 15-high on a cart. Total height on cart is 54"(1372mm). Total depth 55"(1397mm). Height of front edge is 46.5"(1181mm).
- Ganging option: Arm to armless, armless to armless.
- COM yardage / COL square footage:
 Fully Upholstered: 1.5/17.0
 Upholstered seat: 0.8/10.6

To Order, Specify:

1) Product number, including;

1 Seat or Seat Pad Option:

- 1 Leather
- 2 Fabric
- 3 Faux Leather
- 4 Polymer

2 Back or Back Pad Option:

- 1 Leather
- 2 Fabric
- 3 Faux Leather
- 4 Polymer

- 2) Fabric surface and color (seat).
- 3) Fabric surface and color (back).
- 4) Shell color - required for upholstered and non-upholstered.
- 5) Trim for arm caps and plastic components.
- 6) Frame trim color.

Ganging	Number 1 2	Price	Fabric Grade								Leather Grade A	Leather Grade B	
			A	B	C	D	E	F	G	H			
Polymer Shell Without Optional Upholstered Pad													
Non-Ganging	SCH- 4 4 -3S	\$285.56	N/A	N/A	N/A	N/A	N/A	N/A	N/A	N/A	N/A	N/A	N/A
Ganging Glide	SCH- 4 4 -39	296.40	N/A	N/A	N/A	N/A	N/A	N/A	N/A	N/A	N/A	N/A	N/A
Polymer Shell With Upholstered Seat Pad													
Non-Ganging	SCH- 4 -3SE	N/A	\$365.44	\$400.38	\$437.75	\$454.61	\$470.26	\$501.60	\$531.72	\$611.26	\$526.90	\$ 671.31	
Ganging Glide	SCH- 4 -39E	N/A	376.28	411.22	448.59	465.45	481.10	512.44	542.56	622.10	537.74	682.15	
Polymer Shell With Upholstered Seat and Back Pads													
Non-Ganging	SCH- -3SE	N/A	\$438.78	\$508.66	\$583.40	\$617.12	\$648.42	\$711.10	\$771.34	\$930.42	\$761.70	\$1050.52	
Ganging Glide	SCH- -39E	N/A	449.62	519.50	594.24	627.96	659.26	721.94	782.18	941.26	772.54	1061.36	

The following options require modification of the product number.

CAL 133
 Stain repellent

To specify, add **F** to the end of the product number; **Example:** SCH-22-3SEF (add **\$68.68** list)
 To specify, add **P** to end of the product number (add **\$37.35** list)

NOTE: CAL 133 is available on SCH-22 or SCH-33 fully upholstered fabric or faux leather models only.

Stain repellent is available on SCH-22 or SCH-24 models only.

For available fabrics, refer to surfaces.haworth.com.

Very

Wire Stacker

Without Arms



SCH-44-05

Dimensions

- SH: 17.3"(440mm)*
- H: 30.6"(778mm)
- D: 23.3"(591mm)
- W: 21.8"(554mm)
- SW: 18.8"(476mm)*
- SD: 17.3"(439mm)*

* All measurements taken with the BIFMA chair measuring device.

Features

- 11 mm steel rod frame.
- Single piece high-strength polymer shell seat and back with an optional upholstery pad.
- Upholstered seat features 0.5"(12.7mm) foam pad.
- Upholstered back features 0.5"(12.7mm) foam pad.
- Frame: Available painted or trivalent chrome.
- High impact clear nylon glides available with or without ganging option.
- Stacks 10-high on the floor, upholstered or non-upholstered; stacks 40-high non-upholstered on a cart; stacks 25-high upholstered on a cart.
- Ganging option: Arm to armless, armless to armless.
- COM yardage / COL square footage:
Fully Upholstered: 1.5/17.0
Upholstered seat: 0.8/10.6

To Order, Specify:

1) Product number, including;

1 Seat or Seat Pad Option:

- 1 Leather
- 2 Fabric
- 3 Faux Leather
- 4 Polymer

2 Back or Back Pad Option:

- 1 Leather
- 2 Fabric
- 3 Faux Leather
- 4 Polymer

- 2) Fabric surface and color (seat).
- 3) Fabric surface and color (back).
- 4) Shell color - required for upholstered and non-upholstered.
- 5) Frame trim color.

Ganging	Number 1 2	Price	Fabric Grade		C	D	E	F	G	H	Leather Grade A	Leather Grade B
			A	B								
Polymer Shell Without Optional Upholstered Pad												
Non-Ganging	SCH- 4 4 -05	\$222.91	N/A	N/A	N/A	N/A	N/A	N/A	N/A	N/A	N/A	N/A
Ganging Glide	SCH- 4 4 -09	233.75	N/A	N/A	N/A	N/A	N/A	N/A	N/A	N/A	N/A	N/A
Polymer Shell With Upholstered Seat Pad												
Non-Ganging	SCH- 4 -05E	N/A	\$302.79	\$337.73	\$375.10	\$391.96	\$407.61	\$438.95	\$469.07	\$548.61	\$464.25	\$608.66
Ganging Glide	SCH- 4 -09E	N/A	313.63	348.57	385.94	402.80	418.45	449.79	479.91	559.45	475.09	619.50
Polymer Shell With Upholstered Seat and Back Pads												
Non-Ganging	SCH- -05E	N/A	\$376.13	\$446.01	\$520.75	\$554.47	\$585.77	\$648.45	\$708.69	\$867.77	\$699.05	\$987.87
Ganging Glide	SCH- -09E	N/A	386.97	456.85	531.59	565.31	596.61	659.29	719.53	878.61	709.89	998.71

The following options require modification of the product number.

- CAL 133
- Stain repellent

To specify, add **F** to the end of the product number; **Example:** SCH-22-05EF (add **\$68.68** list)
To specify, add **P** to end of the product number (add **\$37.35** list)

NOTE: CAL 133 is available on SCH-22 or SCH-33 fully upholstered fabric or faux leather models only.
Stain repellent is available on SCH-22 or SCH-24 models only.
For available fabrics, refer to surfaces.haworth.com.

Very

Bar Height Wire Stool

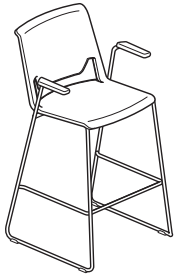

SCW-44-3S

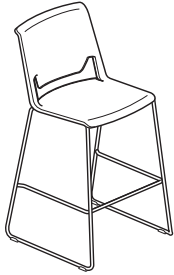

SCW-44-0S

Dimensions

SH: 29.75"(756mm)
 H: 43"(1092mm)
 W: 23"(587mm)
 D: 23"(587mm)
 SW: 18.68"(475mm)
 SD: 17.3"(439mm)

Between Arms:
 19.2"(488mm)

Features

- 11 mm steel rod frame.
- Single piece high-strength polymer shell seat and back with an optional upholstery pad.
- 10 shell color options.
- Upholstered seat features 0.5"(12.7mm) foam pad.
- Upholstered back features 0.5"(12.7mm) foam pad.
- Arms: Black or Fog glass-filled polypropylene arm caps.
- Base: trivalent chrome.
- High impact clear nylon glides.
- Stacks 5-high on the floor.
- Upholstered option.
- 29.75"(756mm) seated height. The foot rest is 11.84"(300.7mm) from the floor.
- COM yardage / COL square footage:
 Fully Upholstered: 1.5/12.5
 Upholstered seat: .8/7.5

To Order, Specify:

1) Product number.

1 Seat or Seat Pad Option:

- 1 Leather
- 2 Fabric
- 3 Faux Leather
- 4 Polymer

2 Back or Back Pad Option:

- 1 Leather
- 2 Fabric
- 3 Faux Leather
- 4 Polymer

- 2) Fabric surface and color (seat).
- 3) Fabric surface and color (back).
- 4) Shell color - required for upholstered and non-upholstered.
- 5) Trim for arm caps (if specified).
- 6) Frame trim color (KR-V only).

Description	Number ①②	Price	Fabric Grade								Leather Grade A	Leather Grade B
			A	B	C	D	E	F	G	H		
Polymer Shell Without Optional Upholstered Pad												
With Arms	SCW- 44 -3S	\$484.38	N/A	N/A	N/A	N/A	N/A	N/A	N/A	N/A	N/A	N/A
Without Arms	SCW- 44 -0S	421.73	N/A	N/A	N/A	N/A	N/A	N/A	N/A	N/A	N/A	N/A
Polymer Shell With Upholstered Seat Pad												
With Arms	SCW- 4 -3SE	N/A	\$564.26	\$599.20	\$636.57	\$653.43	\$669.08	\$700.42	\$730.54	\$ 810.08	\$725.72	\$ 870.13
Without Arms	SCW- 4 -0SE	N/A	501.61	536.55	573.92	590.78	606.43	637.77	667.89	747.43	663.07	807.48
Polymer Shell With Upholstered Seat and Back Pads												
With Arms	SCW- 4 -3SE	N/A	\$637.60	\$707.48	\$782.22	\$815.94	\$847.24	\$909.92	\$970.16	\$1129.24	\$960.52	\$1249.34
Without Arms	SCW- 4 -0SE	N/A	574.95	644.83	719.57	753.29	784.59	847.27	907.51	1066.59	897.87	1186.69

The following options require modification of the product number.

CAL 133
 Stain repellent

To specify, add **F** to the end of the product number; **Example:** SCW-22-0SEF (add **\$68.68** list)
 To specify, add **P** to end of the product number (add **\$37.35** list)

NOTE: CAL 133 is available on SCW-22 or SCW-33 fully upholstered fabric or faux leather models only.

Stain repellent is available on SCW-22 or SCW-24 models only.

For available fabrics, refer to surfaces.haworth.com.

Very

Counter Height Wire Stool

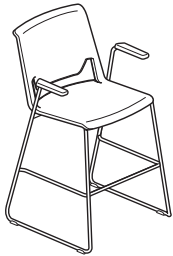

SCWC-44-3S

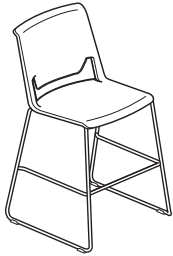

SCWC-44-0S

Dimensions

SH: 25.75"(654mm)
 H: 39"(991mm)
 W: 23"(587mm)
 D: 23"(587mm)
 SW: 18.68"(475mm)
 SD: 17.3"(439mm)

Between Arms:
 19.2"(488mm)

Features

- 11 mm steel rod frame.
- Single piece high-strength polymer shell seat and back with an optional upholstery pad.
- 10 shell color options.
- Upholstered seat features 0.5"(12.7mm) foam pad.
- Upholstered back features 0.5"(12.7mm) foam pad.
- Arms: Black or Fog glass-filled polypropylene arm caps.
- Base: trivalent chrome.
- High impact clear nylon glides.
- Stacks 5-high on the floor.
- Upholstered option.
- 25.75"(654mm) seated height. The foot rest is 7.84"(199.1mm) from the floor.
- COM yardage / COL square footage:
 Fully Upholstered: 1.5/12.5
 Upholstered seat: .8/7.5

To Order, Specify:

1) Product number.

1 Seat or Seat Pad Option:

- 1 Leather
- 2 Fabric
- 3 Faux Leather
- 4 Polymer

2 Back or Back Pad Option:

- 1 Leather
- 2 Fabric
- 3 Faux Leather
- 4 Polymer

- 2) Fabric surface and color (seat).
- 3) Fabric surface and color (back).
- 4) Shell color - required for upholstered and non-upholstered.
- 5) Trim for arm caps (if specified).
- 6) Frame trim color (KR-V only).

Description	Number 1 2	Price	Fabric Grade								Leather Grade A	Leather Grade B	
			A	B	C	D	E	F	G	H			
Polymer Shell Without Optional Upholstered Pad													
With Arms	SCWC- 44 -3S	\$484.38	N/A	N/A	N/A	N/A	N/A	N/A	N/A	N/A	N/A	N/A	N/A
Without Arms	SCWC- 44 -0S	421.73	N/A	N/A	N/A	N/A	N/A	N/A	N/A	N/A	N/A	N/A	N/A
Polymer Shell With Upholstered Seat Pad													
With Arms	SCWC- 4 -3SE	N/A	\$564.26	\$599.20	\$636.57	\$653.43	\$669.08	\$700.42	\$730.54	\$ 810.08	\$725.72	\$ 870.13	
Without Arms	SCWC- 4 -0SE	N/A	501.61	536.55	573.92	590.78	606.43	637.77	667.89	747.43	663.07	807.48	
Polymer Shell With Upholstered Seat and Back Pads													
With Arms	SCWC- 4 -3SE	N/A	\$637.60	\$707.48	\$782.22	\$815.94	\$847.24	\$909.92	\$970.16	\$1129.24	\$960.52	\$1249.34	
Without Arms	SCWC- 4 -0SE	N/A	574.95	644.83	719.57	753.29	784.59	847.27	907.51	1066.59	897.87	1186.69	

The following options require modification of the product number.

CAL 133
 Stain repellent

To specify, add **F** to the end of the product number; **Example:** SCWC-22-0SEF (add **\$68.68** list)
 To specify, add **P** to end of the product number (add **\$37.35** list)

NOTE: CAL 133 is available on SCWC-22 or SCWC-33 fully upholstered fabric or faux leather models only.
 Stain repellent is available on SCWC-22 or SCWC-24 models only.
 For available fabrics, refer to surfaces.haworth.com.

Very Perforated Side, Seminar and Side Stool

General Specifications

Features and Options

(Side, Seminar and Side Chair)

Side and Seminar Chair

- Back: High-strength polymer back with perforations for added flexibility and an optional upholstered foam pad
- Seat: High-strength polymer seat with an optional upholstered foam pad
- Casters: Hard (black), soft (black) or two-tone (fog and gray)
- Glides: Plastic or felt
- Frame finishes include: painted or trivalent chrome
- Weight assisted recline mechanism (Seminar model only)
- Fog or black trim arm caps and glides available
- Arm or armless version available
- Optional Laminate Tablet arm
- Optional Storage rack
- Stacking cart (8-high capacity)
- Stacks 5-high on the floor or 8-high (arms - 69" high x 46" wide x 24" deep), (armless - 57" high x 44" wide x 24" deep) on cart.
- 22mm 14-gauge steel leg tube
- Seminar Chair with intuitive reclining back.

Side Stool

- Back: High-strength polymer back with perforations for added flexibility and an optional upholstered foam pad
- Seat: High-strength polymer seat with an optional upholstered polyurethane foam pad
- Glides: Plastic or felt
- Frame finishes include: painted or trivalent chrome
- Fog or black trim arm caps and glides available
- Arm or armless version available
- Stacks 5-high on the floor

General Guidelines for Product Specification

	S	C	M	-	2	2	-	3	1	E	3A-18	3A-18	TR-FA	TR-F	TR-LE
Product Type	_____	_____	_____	_____	_____	_____	_____	_____	_____	_____	_____	_____	_____	_____	_____
(S) Seating	_____	_____	_____	_____	_____	_____	_____	_____	_____	_____	_____	_____	_____	_____	_____
Product Line	_____	_____	_____	_____	_____	_____	_____	_____	_____	_____	_____	_____	_____	_____	_____
(C) Very	_____	_____	_____	_____	_____	_____	_____	_____	_____	_____	_____	_____	_____	_____	_____
Model	_____	_____	_____	_____	_____	_____	_____	_____	_____	_____	_____	_____	_____	_____	_____
(M) Seminar	_____	_____	_____	_____	_____	_____	_____	_____	_____	_____	_____	_____	_____	_____	_____
(S) Side	_____	_____	_____	_____	_____	_____	_____	_____	_____	_____	_____	_____	_____	_____	_____
(L) Side Stool	_____	_____	_____	_____	_____	_____	_____	_____	_____	_____	_____	_____	_____	_____	_____
Seat Upholstery	_____	_____	_____	_____	_____	_____	_____	_____	_____	_____	_____	_____	_____	_____	_____
(1) Leather	_____	_____	_____	_____	_____	_____	_____	_____	_____	_____	_____	_____	_____	_____	_____
(2) Fabric	_____	_____	_____	_____	_____	_____	_____	_____	_____	_____	_____	_____	_____	_____	_____
(3) Faux Leather	_____	_____	_____	_____	_____	_____	_____	_____	_____	_____	_____	_____	_____	_____	_____
(4) Polymer	_____	_____	_____	_____	_____	_____	_____	_____	_____	_____	_____	_____	_____	_____	_____
Back Upholstery	_____	_____	_____	_____	_____	_____	_____	_____	_____	_____	_____	_____	_____	_____	_____
(1) Leather	_____	_____	_____	_____	_____	_____	_____	_____	_____	_____	_____	_____	_____	_____	_____
(2) Fabric	_____	_____	_____	_____	_____	_____	_____	_____	_____	_____	_____	_____	_____	_____	_____
(3) Faux Leather	_____	_____	_____	_____	_____	_____	_____	_____	_____	_____	_____	_____	_____	_____	_____
(4) Polymer	_____	_____	_____	_____	_____	_____	_____	_____	_____	_____	_____	_____	_____	_____	_____
Arm/Caps	_____	_____	_____	_____	_____	_____	_____	_____	_____	_____	_____	_____	_____	_____	_____
(0) No Arms	_____	_____	_____	_____	_____	_____	_____	_____	_____	_____	_____	_____	_____	_____	_____
(3) Fixed Arms, Hard Caps	_____	_____	_____	_____	_____	_____	_____	_____	_____	_____	_____	_____	_____	_____	_____
Base/Caster	_____	_____	_____	_____	_____	_____	_____	_____	_____	_____	_____	_____	_____	_____	_____
(H) 4-Leg, Plastic Glides	_____	_____	_____	_____	_____	_____	_____	_____	_____	_____	_____	_____	_____	_____	_____
(K) 4-Leg, Felt Glides	_____	_____	_____	_____	_____	_____	_____	_____	_____	_____	_____	_____	_____	_____	_____
(1) 4-Leg, Hard Casters*	_____	_____	_____	_____	_____	_____	_____	_____	_____	_____	_____	_____	_____	_____	_____
(2) 4-Leg, Soft Casters*	_____	_____	_____	_____	_____	_____	_____	_____	_____	_____	_____	_____	_____	_____	_____
(T) 4-Leg, Two-Tone Casters*	_____	_____	_____	_____	_____	_____	_____	_____	_____	_____	_____	_____	_____	_____	_____
Enhanced Upholstery	_____	_____	_____	_____	_____	_____	_____	_____	_____	_____	_____	_____	_____	_____	_____
Seat Upholstery	_____	_____	_____	_____	_____	_____	_____	_____	_____	_____	_____	_____	_____	_____	_____
Tellure	_____	_____	_____	_____	_____	_____	_____	_____	_____	_____	_____	_____	_____	_____	_____
Back Upholstery	_____	_____	_____	_____	_____	_____	_____	_____	_____	_____	_____	_____	_____	_____	_____
Tellure	_____	_____	_____	_____	_____	_____	_____	_____	_____	_____	_____	_____	_____	_____	_____
Shell Color	_____	_____	_____	_____	_____	_____	_____	_____	_____	_____	_____	_____	_____	_____	_____
Tomato	_____	_____	_____	_____	_____	_____	_____	_____	_____	_____	_____	_____	_____	_____	_____
Trim Color	_____	_____	_____	_____	_____	_____	_____	_____	_____	_____	_____	_____	_____	_____	_____
Black	_____	_____	_____	_____	_____	_____	_____	_____	_____	_____	_____	_____	_____	_____	_____
Frame Trim Color	_____	_____	_____	_____	_____	_____	_____	_____	_____	_____	_____	_____	_____	_____	_____
Metallic Silver	_____	_____	_____	_____	_____	_____	_____	_____	_____	_____	_____	_____	_____	_____	_____

*Side and Seminar chairs only.

Very

Side Chair – Perforated

With Arms

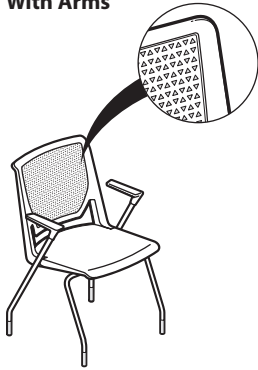

SCS-44-3H

Dimensions

- SH: 18.2"(461mm)*
- H: 33.9"(861mm)
- D: 22"(559mm)
- W: 23.5"(597mm)
- SW: 19.2"(487mm)*
- SD: 17.5"(443mm)*
- AH: 8.9"(226mm)*
- Between Arms:
19.6"(498mm)

* All measurements taken with the BIFMA chair measuring device.

Features

- Back: High-strength polymer back with flexing perforations and an optional upholstered foam pad.
- Seat: High-strength polymer seat with an optional upholstery pad.
- Upholstered seat features 1"(25.4mm) foam pad.
- Upholstered back features 0.5"(12.7mm) foam pad.
- Arms: Black or Fog glass-filled polypropylene arm caps.
- Frame: Available painted or trivalent chrome.
- Casters: Hard (black), soft (black) or two-tone (fog and gray).
- Glides: Plastic or felt.
- Stacks 5-high on the floor and 8-high on a cart with glides and casters.
- COM yardage / COL square footage:
Fully Upholstered: 1.5/17.0
Upholstered seat: 0.75/9.5

To Order, Specify:

1) Product number, including;

1 Seat or Seat Pad Option:

- 1 Leather
- 2 Fabric
- 3 Faux Leather
- 4 Polymer

2 Back or Back Pad Option:

- 1 Leather
- 2 Fabric
- 3 Faux Leather
- 4 Polymer

3 Glide or Caster Option:

- H Plastic Glide
- K Felt Glide
- 1 Hard Casters, add \$43.38 list
- 2 Soft Casters, add \$43.38 list
- T Two-Tone Casters, add \$43.38 list

- 2) Fabric surface and color (seat).
- 3) Fabric surface and color (back).
- 4) Shell color – required for upholstered and non-upholstered.
- 5) Trim for arm caps, glides and plastic components.
- 6) Frame trim color.
Trivalent Chrome (KR-V) add \$186.77 list.

Number 1 2 3	Price	Fabric Grade		C	D	E	F	G	H	Leather Grade A	Leather Grade B
		A	B								
Polymer Shell Without Optional Upholstered Pad											
SCS- 4 4 -3	\$334.97	N/A	N/A	N/A	N/A	N/A	N/A	N/A	N/A	N/A	N/A
Polymer Shell With Upholstered Seat Pad											
SCS- 4 -3 E	N/A	\$415.64	\$450.58	\$487.95	\$504.81	\$520.46	\$551.80	\$581.92	\$661.46	\$577.10	\$ 721.51
Polymer Shell With Upholstered Seat and Back Pads											
SCS- -3 E	N/A	\$490.85	\$560.73	\$635.47	\$669.19	\$700.49	\$763.17	\$823.41	\$982.49	\$813.77	\$1102.59

The following options require modification of the product number.

- CAL 133
Stain repellent

To specify, add **F** to the end of the product number; **Example:** SCS-22-3HEF (add \$68.68 list)
To specify, add **P** to end of the product number (add \$37.35 list)

NOTE: CAL 133 is available on SCS-22 or SCS-33 fully upholstered fabric or faux leather upholstered models only.
Stain repellent is available on SCS-22 and SCS-24 models only.
For available fabrics, refer to surfaces.haworth.com.

Very

Side Chair – Perforated

Without Arms

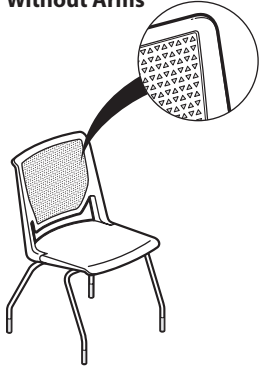

SCS-44-0H

Dimensions

- SH: 18.2"(461mm)*
- H: 33.9"(861mm)
- D: 22"(559mm)
- W: 22.3"(566mm)
- SW: 19.2"(487mm)*
- SD: 17.5"(443mm)*

* All measurements taken with the BIFMA chair measuring device.

Features

- Back: High-strength polymer back with flexing perforations and an optional upholstered foam pad.
- Seat: High-strength polymer seat with an optional upholstery pad.
- Upholstered seat features 1"(25.4mm) foam pad.
- Upholstered back features 0.5"(12.7mm) foam pad.
- Frame: Available painted or trivalent chrome.
- Casters: Hard (black), soft (black) or two-tone (fog and gray).
- Glides: Plastic or felt.
- Stacks 5-high on the floor and 8-high on a cart with glides and casters.
- COM yardage / COL square footage:
Fully Upholstered: 1.5/17
Upholstered seat: 0.75/9.5

To Order, Specify:

1) Product number, including;

1 Seat or Seat Pad Option:

- 1 Leather
- 2 Fabric
- 3 Faux Leather
- 4 Polymer

2 Back or Back Pad Option:

- 1 Leather
- 2 Fabric
- 3 Faux Leather
- 4 Polymer

3 Glide or Caster Option:

- H Plastic Glide
- K Felt Glide
- 1 Hard Casters, add \$43.38 list
- 2 Soft Casters, add \$43.38 list
- T Two-Tone Casters, add \$43.38 list

- 2) Fabric surface and color (seat).
 - 3) Fabric surface and color (back).
 - 4) Shell color – required for upholstered and non-upholstered.
 - 5) Add glide and plastic component trim color.
 - 6) Frame trim color.
- Trivalent Chrome (KR-V) add \$186.77 list.

Number ① ② ③	Price	Fabric Grade		C	D	E	F	G	H	Leather Grade A	Leather Grade B
		A	B								
Polymer Shell Without Optional Upholstered Pad											
SCS- 4 4 -0	\$272.32	N/A	N/A	N/A	N/A	N/A	N/A	N/A	N/A	N/A	N/A
Polymer Shell With Upholstered Seat Pad											
SCS- 4 -0 E	N/A	\$352.99	\$387.93	\$425.30	\$442.16	\$457.81	\$489.15	\$519.27	\$598.81	\$514.45	\$ 658.86
Polymer Shell With Upholstered Seat and Back Pads											
SCS- -0 E	N/A	\$428.20	\$498.08	\$572.82	\$606.54	\$637.84	\$700.52	\$760.76	\$919.84	\$751.12	\$1039.94

The following options require modification of the product number.

CAL 133

Stain repellent

To specify, add **F** to the end of the product number; **Example:** SCS-22-0HEF (add \$68.68 list)

To specify, add **P** to end of the product number (add \$37.35 list)

NOTE: CAL 133 is available on SCS-22 or SCS-33 fully upholstered fabric or faux leather models only.

Stain repellent is available on SCS-22 and SCS-24 models only.

For available fabrics, refer to surfaces.haworth.com.

Very

Side Chair with Tablet Arm – Perforated Back

Side With Tablet Arm

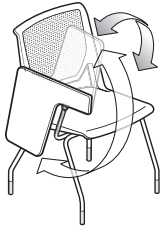

SCS-44-RH

Dimensions

- SH: 18.2"(461mm)*
- H: 33.9"(861mm)
- W: 23.5"(597mm)
- D: 22"(559mm)
- SW: 19.2"(487mm)*
- SD: 17.5"(443mm)*

Features

- Back: High-strength polymer back with flexing perforations and an optional upholstery pad.
- Seat: High-strength polymer with an optional upholstery pad.
- Upholstered seat features 1"(25.4mm) foam pad.
- Upholstered back features 0.5"(12.7mm) foam pad.
- Arm cap: Black.
- Tablet assembly painted black.
- Clearance from tablet to chair back 12.5"(318mm)-15.5"(394mm) angled.
- Flips up and fold away laminate tablet with matching laminate underside.
- Left or right-hand configurations.
- Tablet arm size: 15"W x 9.8"D (Sized to accommodate laptops).
- Base: available painted or optional trivalent chrome.
- Glides or Casters.
- Standard with hard casters, black or two-tone.
- Optional black soft casters.
- COM yardage / COL square footage:
Fully Upholstered: 1.5/13
Upholstered seat: .75/7.25

*All measurements taken with the BIFMA chair measuring device.

To Order, Specify:

1) Product number.

1 Seat or Seat Pad Option:

- 1 Leather
- 2 Fabric
- 3 Faux Leather
- 4 Polymer

2 Back or Back Pad Option:

- 1 Leather
- 2 Fabric
- 3 Faux Leather
- 4 Perforated Polymer

3 Arm or Tablet Option:

- R Right-Hand Tablet Arm
- L Left-Hand Tablet Arm

4 Glide or Caster Option:

- H Plastic Glide
- K Felt Glide
- 1 Hard Casters, add **\$43.38** list
- 2 Soft Casters, add **\$43.38** list
- T Two-Tone Casters, add **\$43.38** list

- 2) Fabric surface and color (seat).
- 3) Fabric surface and color (back).
- 4) Shell color - required for upholstered and non-upholstered.
- 5) Trim for arm caps (if specified) and glides.
- 6) Frame trim color.
Trivalent Chrome (KR-V) add **\$186.77** list.
- 7) Laminate for tablet (if specified).

Description	Number 1 2 3 4	Price	Fabric Grade								Leather Grade A	Leather Grade B
			A	B	C	D	E	F	G	H		
Without Optional Upholstered Pad												
SCS- 4 4 -		\$483.18	N/A	N/A	N/A	N/A	N/A	N/A	N/A	N/A	N/A	N/A
With Upholstered Seat Pad												
SCS- 4 -	E	N/A	\$563.85	\$598.79	\$636.16	\$653.02	\$668.67	\$700.01	\$730.13	\$ 809.67	\$725.31	\$ 869.72
With Upholstered Seat and Back Pads												
SCS- -	E	N/A	\$639.06	\$708.94	\$783.68	\$817.40	\$848.70	\$880.04	\$971.62	\$1130.70	\$961.98	\$1250.80

The following options require modification of the product number.

Stain repellent

To specify, add **P** to end of the product number; **Example:** SCS-22-RHEP (add **\$37.35** list)

Very

Side Chair with Storage Rack – Perforated Back



SCK-44-3H

Dimensions

- SH: 18.2"(461mm)*
- H: 33.9"(861mm)
- W: 23.5"(597mm)
- D: 22"(559mm)
- SW: 19.2"(487mm)*
- SD: 17.5"(443mm)*
- AH: 8.9"(226mm)*

Between Arms:
19.6"(498mm)

Features

- Back: High-strength polymer back with flexing perforations and an optional upholstery pad.
- Seat: Injection-molded with an optional upholstery pad.
- Upholstered seat features 1"(25.4mm) foam pad.
- Upholstered back features 0.5"(12.7mm) foam pad.
- Storage rack ships unassembled (chrome only).
- Arms: Black or Fog arm caps when no tablet is specified.
- Optional Tablet arm:
 - Tablet assembly painted black.
 - Flips up and fold away laminate tablet with matching laminate underside.
 - Left or right-hand configurations.
 - Tablet arm size: 15"W x 9.8"D (Sized to accommodate laptops).
- Base: available painted or optional trivalent chrome.
- Glides or Casters: Standard with hard casters, black or two-tone.
- Optional black soft casters.
- COM yardage / COL square footage:
 - Fully Upholstered: 1.5/13
 - Upholstered seat: .75/7.25

*All measurements taken with the BIFMA chair measuring device.

To Order, Specify:

1) Product number.

1 Seat or Seat Pad Option:

- 1 Leather
- 2 Fabric
- 3 Faux Leather
- 4 Polymer

2 Back or Back Pad Option:

- 1 Leather
- 2 Fabric
- 3 Faux Leather
- 4 Perforated Polymer

3 Arm or Cap Option:

- R Right-Hand Tablet Arm, add **\$210.86** list
- L Left-Hand Tablet Arm, add **\$210.86** list
- 0 No Arms
- 3 Fixed Arm, Hard Caps, add **\$62.65** list

4 Glide or Caster Option:

- H Plastic Glide
- K Felt Glide
- 1 Hard Casters, add **\$43.38** list
- 2 Soft Casters, add **\$43.38** list
- T Two-Tone Casters, add **\$43.38** list

2) Fabric surface and color (seat).

3) Fabric surface and color (back).

4) Shell color - required for upholstered and non-upholstered.

5) Trim for arm caps (if specified) and glides.

6) Frame trim color.

Trivalent Chrome (KR-V) add **\$186.77** list.

7) Laminate for tablet (if specified).

Description	Number 1 2 3 4	Price	Fabric Grade							Leather Grade A	Leather Grade B	
			A	B	C	D	E	F	G			H
Without Optional Upholstered Pad												
SCK- 4 4 - ■ ■		\$350.63	N/A	N/A	N/A	N/A	N/A	N/A	N/A	N/A	N/A	N/A
With Upholstered Seat Pad												
SCK- ■ 4 - ■ ■ E		N/A	\$431.30	\$466.24	\$503.61	\$520.47	\$536.12	\$567.46	\$597.58	\$677.12	\$592.76	\$ 737.17
With Upholstered Seat and Back Pads												
SCK- ■ ■ - ■ ■ E		N/A	\$506.51	\$576.39	\$651.13	\$684.85	\$716.15	\$778.83	\$839.07	\$998.15	\$829.43	\$1118.25

The following options require modification of the product number.

Stain repellent

To specify, add **P** to end of the product number; **Example:** SCK-22-RHEP (add **\$37.35** list)

Very

Bar Height Side Stool – Perforated Back

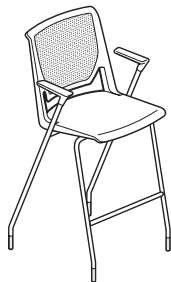

SCL-44-3H

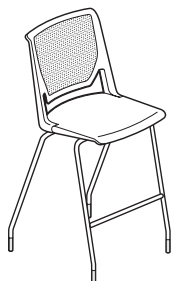

SCL-44-0H

Dimensions

SH: 29.75"(756mm)
 H: 46.25"(1175mm)
 W: 23.75"(604mm)
 D: 23"(587mm)
 SW: 18.75"(477mm)
 SD: 17.2"(434mm)
 AH: 8.9"(226mm)

Between Arms:
 19.6"(498mm)

Features

- Back options: High-strength polymer with flexing perforations and an optional upholstery pad.
- Seat: Injection-molded high-strength polymer seat with an optional upholstery pad.
- Upholstered seat features 1"(25.4mm) foam pad.
- Upholstered back features 0.5"(12.7mm) foam pad.
- Arms: Black or Fog high-strength polymer arm caps.
- Base: available painted or optional trivalent chrome.
- Standard with glides.
- Stacks 5 high on the floor.
- COM yardage / COL square footage:
 Fully Upholstered: 1.5/13
 Upholstered seat: .75/7.25

To Order, Specify:

1) Product number.

1 Seat or Seat Pad Option:

- 1 Leather
- 2 Fabric
- 3 Faux Leather
- 4 Polymer

2 Back or Back Pad Option:

- 1 Leather
- 2 Fabric
- 3 Faux Leather
- 4 Perforated Polymer

3 Glide Option:

- H Plastic Glide
- K Felt Glide

- 2) Fabric surface and color (seat).
 - 3) Fabric surface and color (back).
 - 4) Shell color - required for upholstered and non-upholstered.
 - 5) Trim for arm caps (if specified) and glides.
 - 6) Frame trim color.
- Trivalent Chrome (KR-V) add **\$186.77** list.

Description	Number			Price	Fabric Grade								Leather Grade A	Leather Grade B
	1	2	3		A	B	C	D	E	F	G	H		
Without Optional Upholstered Pad														
With Arms	SCL-	44	-3	\$695.25	N/A	N/A	N/A	N/A	N/A	N/A	N/A	N/A	N/A	N/A
Without Arms	SCL-	44	-0	632.60	N/A	N/A	N/A	N/A	N/A	N/A	N/A	N/A	N/A	N/A
With Upholstered Seat Pad														
With Arms	SCL-	4	-3	N/A	\$775.92	\$810.86	\$848.23	\$ 865.09	\$ 880.74	\$ 912.08	\$ 942.20	\$1021.74	\$ 937.38	\$1081.79
Without Arms	SCL-	4	-0	N/A	713.27	748.21	785.58	802.44	818.09	849.43	879.55	959.09	874.73	1019.14
With Upholstered Seat and Back Pads														
With Arms	SCL-		-3	N/A	\$851.13	\$921.01	\$995.75	\$1029.47	\$1060.77	\$1123.45	\$1183.69	\$1342.77	\$1174.05	\$1462.87
Without Arms	SCL-		-0	N/A	788.48	858.36	933.10	966.82	998.12	1060.80	1121.04	1280.12	1111.40	1400.22

The following options require modification of the product number.

CAL 133
 Stain repellent

To specify, add **F** to the end of the product number; **Example:** SCL-22-3HEF (add **\$68.68** list)
 To specify, add **P** to end of the product number; **Example:** SCL-22-3HEP (add **\$37.35** list)

NOTE: CAL 133 is available on SCL-22 or SCL-33 fully upholstered fabric or faux leather models only.
 Stain repellent is available on SCL-22 or SCL-24 models only.
 For available fabrics, refer to surfaces.haworth.com.

Very

Counter Height Side Stool – Perforated Back

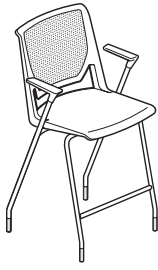

SCLC-44-3H

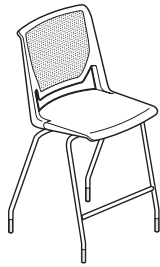

SCLC-44-0H

Dimensions

SH: 25.75"(654mm)
 H: 42.25"(1073mm)
 W: 23.75"(604mm)
 D: 21.7"(551mm)
 SW: 18.75"(477mm)
 SD: 17.2"(434mm)
 AH: 8.9"(226mm)

Between Arms:
 19.6"(498mm)

Features

- Back options: High-strength polymer with flexing perforations and an optional upholstery pad.
- Seat: Injection-molded high-strength polymer seat with an optional upholstery pad.
- Upholstered seat features 1"(25.4mm) foam pad.
- Upholstered back features 0.5"(12.7mm) foam pad.
- Arms: Black or Fog high-strength polymer arm caps.
- Base: available painted or optional trivalent chrome.
- Standard with glides.
- Stacks 5 high on the floor.
- COM yardage / COL square footage:
 Fully Upholstered: 1.5/13
 Upholstered seat: .75/7.25

To Order, Specify:

1) Product number.

1 Seat or Seat Pad Option:

- 1 Leather
- 2 Fabric
- 3 Faux Leather
- 4 Polymer

2 Back or Back Pad Option:

- 1 Leather
- 2 Fabric
- 3 Faux Leather
- 4 Perforated Polymer

3 Glide Option:

- H Plastic Glide
- K Felt Glide

2) Fabric surface and color (seat).

3) Fabric surface and color (back).

4) Shell color - required for upholstered and non-upholstered.

5) Trim for arm caps (if specified) and glides.

6) Frame trim color.

Trivalent Chrome (KR-V) add **\$186.77** list.

Description	Number			Price	Fabric Grade								Leather Grade A	Leather Grade B
	1	2	3		A	B	C	D	E	F	G	H		
Without Optional Upholstered Pad														
With Arms	SCLC-	44	-3	\$695.25	N/A	N/A	N/A	N/A	N/A	N/A	N/A	N/A	N/A	N/A
Without Arms	SCLC-	44	-0	632.60	N/A	N/A	N/A	N/A	N/A	N/A	N/A	N/A	N/A	N/A
With Upholstered Seat Pad														
With Arms	SCLC-	4	-3	N/A	\$775.92	\$810.86	\$848.23	\$ 865.09	\$ 880.74	\$ 912.08	\$ 942.20	\$1021.74	\$ 937.38	\$1081.79
Without Arms	SCLC-	4	-0	N/A	713.27	748.21	785.58	802.44	818.09	849.43	879.55	959.09	874.73	1019.14
With Upholstered Seat and Back Pads														
With Arms	SCLC-		-3	N/A	\$851.13	\$921.01	\$995.75	\$1029.47	\$1060.77	\$1123.45	\$1183.69	\$1342.77	\$1174.05	\$1462.87
Without Arms	SCLC-		-0	N/A	788.48	858.36	933.10	966.82	998.12	1060.80	1121.04	1280.12	1111.40	1400.22

The following options require modification of the product number.

CAL 133

Stain repellent

To specify, add **F** to the end of the product number; **Example:** SCLC-22-3HEF (add **\$68.68** list)

To specify, add **P** to end of the product number; **Example:** SCLC-22-3HEP (add **\$37.35** list)

NOTE: CAL 133 is available on SCLC-22 or SCLC-33 fully upholstered fabric or faux leather models only.

Stain repellent is available on SCLC-22 or SCLC-24 models only.

For available fabrics, refer to surfaces.haworth.com.

Very Seminar Chair – Perforated

With Arms

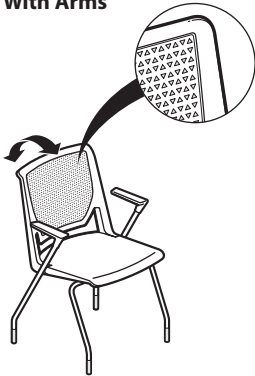

SCM-44-3H

Dimensions

- SH: 18.2"(461mm)*
- H: 33.9"(861mm)
- D: 22"(559mm)
- W: 23.5"(597mm)
- SW: 19.2"(487mm)*
- SD: 17.5"(443mm)*
- AH: 8.9"(226mm)*
- Between Arms:
19.6"(498mm)

* All measurements taken with the BIFMA chair measuring device.

Features

- Back: High-strength polymer back with flexing perforations and an optional upholstered foam pad.
- Seat: High-strength polymer seat with an optional upholstery pad.
- Weight assisted recline mechanism.
- Upholstered seat features 1"(25.4mm) foam pad.
- Upholstered back features 0.5"(12.7mm) foam pad.
- Arms: Black or Fog glass-filled polypropylene arm caps.
- Frame: Available painted or trivalent chrome.
- Casters: Hard (black), soft (black) or two-tone (fog and gray).
- Glides: Plastic or felt.
- Stacks 5-high on the floor and 8-high on a cart with glides and casters.
- COM yardage / COL square footage:
Fully Upholstered: 1.5/17
Upholstered seat: 0.75/9.5

To Order, Specify:

1) Product number, including;

1 Seat or Seat Pad Option:

- 1 Leather
- 2 Fabric
- 3 Faux Leather
- 4 Polymer

2 Back or Back Pad Option:

- 1 Leather
- 2 Fabric
- 3 Faux Leather
- 4 Polymer

3 Glide or Caster Option:

- H Plastic Glide
- K Felt Glide
- 1 Hard Casters, add \$55.42 list
- 2 Soft Casters, add \$55.42 list
- T Two-Tone Casters, add \$55.42 list

- 2) Fabric surface and color (seat).
- 3) Fabric surface and color (back).
- 4) Shell color – required for upholstered and non-upholstered.
- 5) Trim for arm caps, glides, and plastic components.
- 6) Frame trim color.
Trivalent Chrome (KR-V) add \$186.77 list.

Number 1 2 3	Price	Fabric Grade		C	D	E	F	G	H	Leather Grade A	Leather Grade B
		A	B								
Polymer Shell Without Optional Upholstered Pad											
SCM- 4 4 -3	\$577.16	N/A	N/A	N/A	N/A	N/A	N/A	N/A	N/A	N/A	N/A
Polymer Shell With Upholstered Seat Pad											
SCM- 4 -3 E	N/A	\$679.44	\$714.38	\$751.75	\$768.61	\$784.26	\$ 815.60	\$ 845.72	\$ 925.26	\$ 840.90	\$ 985.31
Polymer Shell With Upholstered Seat and Back Pads											
SCM- -3 E	N/A	\$757.93	\$827.81	\$902.55	\$936.27	\$967.57	\$1030.25	\$1090.49	\$1249.57	\$1080.85	\$1369.67

The following options require modification of the product number.

- CAL 133
- Stain repellent

To specify, add **F** to the end of the product number; **Example:** SCM-22-3HEF (add \$68.68 list)
To specify, add **P** to end of the product number (add \$37.35 list)

NOTE: CAL 133 is available on SCM-22 or SCM-33 fully upholstered fabric or faux leather models only.
Stain repellent is available on SCM-22 and SCM-24 models only.
For available fabrics, refer to surfaces.haworth.com.

Very

Seminar Chair – Perforated

Without Arms

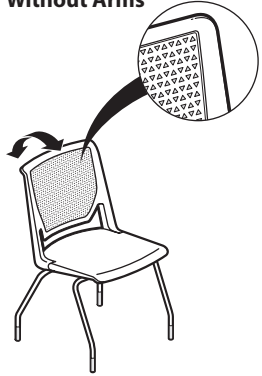

SCM-44-0H

Dimensions

- SH: 18.2"(461mm)*
- H: 33.9"(861mm)
- D: 22"(559mm)
- W: 22.3"(566mm)
- SW: 19.2"(487mm)*
- SD: 17.5"(443mm)*

* All measurements taken with the BIFMA chair measuring device.

Features

- Back: High-strength polymer back with flexing perforations and an optional upholstered foam pad.
- Seat: High-strength polymer seat with an optional upholstery pad.
- Weight assisted recline mechanism.
- Upholstered seat features 1"(25.4mm) foam pad.
- Upholstered back features 0.5"(12.7mm) foam pad.
- Arms: Black or Fog glass-filled polypropylene arm caps.
- Frame: Available painted or trivalent chrome.
- Casters: Hard (black), soft (black) or two-tone (fog and gray).
- Glides: Plastic or felt.
- Stacks 5-high on the floor and 8-high on a cart with glides and casters.
- COM yardage / COL square footage:
Fully Upholstered: 1.5/17
Upholstered seat: 0.75/9.5

To Order, Specify:

1) Product number, including;

1 Seat or Seat Pad Option:

- 1 Leather
- 2 Fabric
- 3 Faux Leather
- 4 Polymer

2 Back or Back Pad Option:

- 1 Leather
- 2 Fabric
- 3 Faux Leather
- 4 Polymer

3 Glide or Caster Option:

- H Plastic Glide
- K Felt Glide
- 1 Hard Casters, add \$55.42 list
- 2 Soft Casters, add \$55.42 list
- T Two-Tone Casters, add \$55.42 list

- 2) Fabric surface and color (seat).
- 3) Fabric surface and color (back).
- 4) Shell color – required for upholstered and non-upholstered.
- 5) Glide and plastic component trim color.
- 6) Frame trim color.
- Trivalent Chrome (KR-V) add \$186.77 list.

Number 1 2 3	Price	Fabric Grade										Leather Grade A	Leather Grade B
		A	B	C	D	E	F	G	H				
Polymer Shell Without Optional Upholstered Pad													
SCM- 4 4 -0	\$514.51	N/A	N/A	N/A	N/A	N/A	N/A	N/A	N/A	N/A	N/A	N/A	N/A
Polymer Shell With Upholstered Seat Pad													
SCM- 4 4 -0 E	N/A	\$616.79	\$651.73	\$689.10	\$705.96	\$721.61	\$752.95	\$ 783.07	\$ 862.61	\$ 778.25	\$ 922.66		
Polymer Shell With Upholstered Seat and Back Pads													
SCM- 4 4 -0 E	N/A	\$695.28	\$765.16	\$839.90	\$873.62	\$904.92	\$967.60	\$1027.84	\$1186.92	\$1018.20	\$1307.02		

The following options require modification of the product number.

CAL 133

Stain repellent

To specify, add **F** to the end of the product number; **Example:** SCM-22-0HEF (add \$68.68 list)

To specify, add **P** to end of the product number (add \$37.35 list)

NOTE: CAL 133 is available on SCM-22 or SCM-33 fully upholstered fabric or faux leather models only.

Stain repellent is available on SCM-22 and SCM-24 models only.

For available fabrics, refer to surfaces.haworth.com.

Very

Seminar with Tablet Arm – Perforated Back

Seminar With Tablet Arm

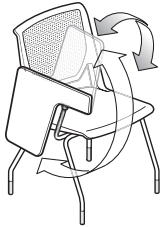

SCM-44-RH

Dimensions

- SH: 18.2"(461mm)*
- H: 33.9"(861mm)
- W: 23.5"(597mm)
- D: 22"(559mm)
- SW: 19.2"(487mm)*
- SD: 17.5"(443mm)*

Features

- Back: High-strength polymer back with flexing perforations and an optional upholstery pad.
- Seat: High-strength polymer with an optional upholstery pad.
- Weight assisted recline mechanism.
- Upholstered seat features 1"(25.4mm) foam pad.
- Upholstered back features 0.5"(12.7mm) foam pad.
- Arm caps: Black.
- Tablet assembly painted black.
- Clearance from tablet to chair back 12.5"(318mm)-15.5"(394mm) angled.
- Flips up and fold away laminate tablet with matching laminate underside.
- Left or right-hand configurations.
- Tablet arm size: 15"W x 9.8"D (Sized to accommodate laptops).
- Base: available painted or optional trivalent chrome.
- Glides or Casters.
- Standard with hard casters, black or two-tone.
- Optional black soft casters.
- COM yardage / COL square footage:
Fully Upholstered: 1.5/13
Upholstered seat: .75/7.25

*All measurements taken with the BIFMA chair measuring device.

To Order, Specify:

1) Product number.

1 Seat or Seat Pad Option:

- 1 Leather
- 2 Fabric
- 3 Faux Leather
- 4 Polymer

2 Back or Back Pad Option:

- 1 Leather
- 2 Fabric
- 3 Faux Leather
- 4 Perforated Polymer

3 Arm or Tablet Option:

- R Right-Hand Tablet Arm
- L Left-Hand Tablet Arm

4 Glide or Caster Option:

- H Plastic Glide
- K Felt Glide
- 1 Hard Casters, add **\$55.42** list
- 2 Soft Casters, add **\$55.42** list
- T Two-Tone Casters, add **\$55.42** list

- 2) Fabric surface and color (seat).
- 3) Fabric surface and color (back).
- 4) Shell color - required for upholstered and non-upholstered.
- 5) Trim for arm caps (if specified) and glides.
- 6) Frame trim color.
Trivalent Chrome (KR-V) add **\$186.77** list.
- 7) Laminate for tablet (if specified).

Description	Number 1 2 3 4	Price	Fabric Grade								Leather Grade A	Leather Grade B
			A	B	C	D	E	F	G	H		
Without Optional Upholstered Pad												
SCM- 4 4 -		\$725.37	N/A	N/A	N/A	N/A	N/A	N/A	N/A	N/A	N/A	N/A
With Upholstered Seat Pad												
SCM- 4 -	E	N/A	\$827.65	\$862.59	\$ 899.96	\$ 916.82	\$ 932.47	\$ 963.81	\$ 993.93	\$1073.47	\$ 989.11	\$1133.52
With Upholstered Seat and Back Pads												
SCM- -	E	N/A	\$906.14	\$976.02	\$1050.76	\$1084.48	\$1115.78	\$1178.46	\$1238.70	\$1397.78	\$1229.06	\$1517.88

The following options require modification of the product number.

Stain repellent

To specify, add **P** to end of the product number; **Example:** SCM-22-RHEP (add **\$37.35** list)

Very

Seminar with Storage Rack – Perforated Back

Seminar With Storage Rack

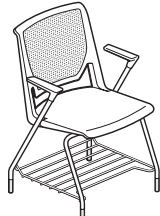

SCB-44-3H

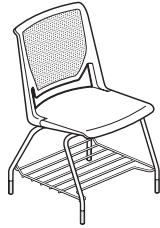

SCB-44-0H

Dimensions

- SH: 18.2"(461mm)*
- H: 33.9"(861mm)
- W: 23.5"(597mm)
- D: 22"(559mm)
- SW: 19.2"(487mm)*
- SD: 17.5"(443mm)*
- AH: 8.9"(226mm)*

Between Arms:
19.6"(498mm)

Features

- Back: High-strength polymer back with flexing perforations and an optional upholstery pad.
- Seat: High-strength polymer seat with an optional upholstery pad.
- Weight assisted recline mechanism.
- Upholstered seat features 1"(25.4mm) foam pad.
- Upholstered back features 0.5"(12.7mm) foam pad.
- Arms: Black or Fog arm caps.
- Storage rack available in Chrome only.
- Tablet assembly painted black.
- Flips up and fold away laminate tablet with matching laminate underside.
- Left or right-hand configurations.
- Tablet arm size: 15"W x 9.8"D (Sized to accommodate laptops).
- Ships with chair, unassembled.
- Base: available painted or optional trivalent chrome.
- Glides or Casters: Standard with hard casters, black or two-tone.
- Optional black soft casters.
- COM yardage / COL square footage:
Fully Upholstered: 1.5/13
Upholstered seat: .75/7.25

*All measurements taken with the BIFMA chair measuring device.

To Order, Specify:

1) Product number.

1 Seat or Seat Pad Option:

- 1 Leather
- 2 Fabric
- 3 Faux Leather
- 4 Polymer Back or Back Pad

2 Back or Back Pad Option:

- 1 Leather
- 2 Fabric Faux Leather
- 4 Perforated Polymer

3 Arm or Cap Option:

- R Right-Hand Tablet Arm, add **\$210.86** list
- L Left-Hand Tablet Arm, add **\$210.86** list
- 0 No Arms
- 3 Fixed Arm, Hard Caps, add **\$62.65** list

4 Glide or Caster Option:

- H Plastic Glide
- K Felt Glide
- 1 Hard Casters, add **\$55.42** list
- 2 Soft Casters, add **\$55.42** list
- T Two-Tone Casters, add **\$55.42** list

2) Fabric surface and color (seat).

3) Fabric surface and color (back).

4) Shell color - required for upholstered and non-upholstered.

5) Trim for arm caps (if specified) and glides.

6) Frame trim color.

Trivalent Chrome (KR-V) add **\$186.77** list.

Description	Number				Price	Fabric Grade						Leather Grade A	Leather Grade B		
	1	2	3	4		A	B	C	D	E	F			G	H
Without Optional Upholstered Pad															
SCB- 4 4 -					\$592.82	N/A	N/A	N/A	N/A	N/A	N/A	N/A	N/A	N/A	
With Upholstered Seat Pad															
SCB- 4 -				E	N/A	\$695.10	\$730.04	\$767.41	\$784.27	\$799.92	\$ 831.26	\$ 861.38	\$ 940.92	\$ 856.56	\$1000.97
With Upholstered Seat and Back Pads															
SCB- - -				E	N/A	\$773.59	\$843.47	\$918.21	\$951.93	\$983.23	\$1045.91	\$1106.15	\$1265.23	\$1096.51	\$1385.33

The following options require modification of the product number.

Stain repellent

To specify, add **P** to end of the product number; **Example:** SCB-22-RHEP (add **\$37.35** list)

Very Perforated Conference Chair and Conference Stool

General Specifications

**Features and Options
(Conference Chair and Conference Stool)**

- Back: High-strength polymer back with flexing perforations and an optional upholstered foam pad
- Seat: High-strength polymer seat with an optional upholstered polyurethane foam pad
- Five-star base with casters: hard (black), soft (black) or two-tone (fog and gray)
- Base: painted aluminum, polished aluminum or plastic (fog or black)
- Frame finishes include: painted or polished aluminum
- Weight assisted recline mechanism
- Pneumatic height adjustment
- Fog or black trim arm caps
- Arm or armless version available
- Adjustable footring in brushed aluminum (stool only)

**General Guidelines for
Product Specification**

	S	C	C - 2	2 - 1	1	E	3A-18	3A-18	TR-FA	TR-F	TR-LE
Conference											
Product Type	_____	_____	_____	_____	_____	_____	_____	_____	_____	_____	_____
(S) Seating	_____	_____	_____	_____	_____	_____	_____	_____	_____	_____	_____
Product Line	_____	_____	_____	_____	_____	_____	_____	_____	_____	_____	_____
(C) Very	_____	_____	_____	_____	_____	_____	_____	_____	_____	_____	_____
Model	_____	_____	_____	_____	_____	_____	_____	_____	_____	_____	_____
(C) Conference	_____	_____	_____	_____	_____	_____	_____	_____	_____	_____	_____
(F) Stool	_____	_____	_____	_____	_____	_____	_____	_____	_____	_____	_____
Seat Upholstery	_____	_____	_____	_____	_____	_____	_____	_____	_____	_____	_____
(1) Leather	_____	_____	_____	_____	_____	_____	_____	_____	_____	_____	_____
(2) Fabric	_____	_____	_____	_____	_____	_____	_____	_____	_____	_____	_____
(3) Faux Leather	_____	_____	_____	_____	_____	_____	_____	_____	_____	_____	_____
(4) Polymer	_____	_____	_____	_____	_____	_____	_____	_____	_____	_____	_____
Back Upholstery	_____	_____	_____	_____	_____	_____	_____	_____	_____	_____	_____
(1) Leather	_____	_____	_____	_____	_____	_____	_____	_____	_____	_____	_____
(2) Fabric	_____	_____	_____	_____	_____	_____	_____	_____	_____	_____	_____
(3) Faux Leather	_____	_____	_____	_____	_____	_____	_____	_____	_____	_____	_____
(4) Polymer	_____	_____	_____	_____	_____	_____	_____	_____	_____	_____	_____
Arm/Caps	_____	_____	_____	_____	_____	_____	_____	_____	_____	_____	_____
(0) No Arms	_____	_____	_____	_____	_____	_____	_____	_____	_____	_____	_____
(1) Fixed Arms, Soft Caps	_____	_____	_____	_____	_____	_____	_____	_____	_____	_____	_____
Base/Caster	_____	_____	_____	_____	_____	_____	_____	_____	_____	_____	_____
(1) Aluminum Standard Base, Hard Caster	_____	_____	_____	_____	_____	_____	_____	_____	_____	_____	_____
(2) Aluminum Standard Base, Soft Caster	_____	_____	_____	_____	_____	_____	_____	_____	_____	_____	_____
(3) Aluminum Low Base, Hard Caster	_____	_____	_____	_____	_____	_____	_____	_____	_____	_____	_____
(4) Aluminum Low Base, Soft Caster	_____	_____	_____	_____	_____	_____	_____	_____	_____	_____	_____
(5) Plastic Standard Base, Hard Caster	_____	_____	_____	_____	_____	_____	_____	_____	_____	_____	_____
(6) Plastic Standard Base, Soft Caster	_____	_____	_____	_____	_____	_____	_____	_____	_____	_____	_____
(7) Plastic Low Base, Hard Caster	_____	_____	_____	_____	_____	_____	_____	_____	_____	_____	_____
(8) Plastic Low Base, Soft Caster	_____	_____	_____	_____	_____	_____	_____	_____	_____	_____	_____
(N) Plastic Low Base, Two-Tone Casters	_____	_____	_____	_____	_____	_____	_____	_____	_____	_____	_____
(P) Plastic Standard Base, Two-Tone Casters	_____	_____	_____	_____	_____	_____	_____	_____	_____	_____	_____
(R) Aluminum Low Base, Two-Tone Casters	_____	_____	_____	_____	_____	_____	_____	_____	_____	_____	_____
(T) Aluminum Standard Base, Two-Tone Casters	_____	_____	_____	_____	_____	_____	_____	_____	_____	_____	_____
Enhanced Upholstery	_____	_____	_____	_____	_____	_____	_____	_____	_____	_____	_____
Seat Upholstery	_____	_____	_____	_____	_____	_____	_____	_____	_____	_____	_____
Tellure	_____	_____	_____	_____	_____	_____	_____	_____	_____	_____	_____
Back Upholstery	_____	_____	_____	_____	_____	_____	_____	_____	_____	_____	_____
Tellure	_____	_____	_____	_____	_____	_____	_____	_____	_____	_____	_____
Shell Color	_____	_____	_____	_____	_____	_____	_____	_____	_____	_____	_____
Tomato	_____	_____	_____	_____	_____	_____	_____	_____	_____	_____	_____
Trim Color	_____	_____	_____	_____	_____	_____	_____	_____	_____	_____	_____
Black	_____	_____	_____	_____	_____	_____	_____	_____	_____	_____	_____
Frame Trim Color	_____	_____	_____	_____	_____	_____	_____	_____	_____	_____	_____
Metallic Silver	_____	_____	_____	_____	_____	_____	_____	_____	_____	_____	_____

Very

Conference Chair - Perforated

With Arms



SCC-44-11

Dimensions

- SH: 15.5"(394mm)-20.5"(521mm)*
- H: 36.9"(937mm)
- D: 26.7"(678mm)
- W: 25"(635mm)
- SW: 19.2"(487mm)*
- SD: 17.5"(443mm)*
- AH: 8.7"(220mm)*
- Between Arms: 20.8"(528mm)

Low position base:

- SH: 14.4"(366mm)-19.4"(493mm)*

* All measurements taken with the BIFMA chair measuring device.

Features

- Back: High-strength polymer with flexing perforations and an optional upholstered foam pad.
- Seat: High-strength polymer with an optional upholstered foam pad.
- Upholstered seat features 1"(25.4mm) foam pad.
- Upholstered back features 0.5"(12.7mm) foam pad.
- Arms: Black or Fog glass-filled polypropylene hard arm caps.
- Base: Standard five-star all aluminum or all plastic base. Optional low-base range 14.4"(366mm)-19.4(493mm).
- 5"(127mm) height adjustment.
- Weight assisted recline mechanism.
- Casters: Hard (black), soft (black) or two-tone (fog and gray).
- Back tilts backward 14° from the upright position. Additional recline achieved in flexible back.
- Painted or optional polished aluminum.
- COM yardage / COL square footage:
Fully Upholstered: 1.5/17
Upholstered seat: 0.75/9.5

To Order, Specify (cont'd):

3 Base/Caster Option:

Aluminum Base

- 1 Aluminum Std. Base, Hard Caster
- 2 Aluminum Std. Base, Soft Caster
- 3 Aluminum Low Base, Hard Caster
- 4 Aluminum Low Base, Soft Caster

Plastic Base

- 5 Plastic Std. Base, Hard Caster
- 6 Plastic Std. Base, Soft Caster
- 7 Plastic Low Base, Hard Caster
- 8 Plastic Low Base, Soft Caster

Two-Tone Casters

- N Plastic Low Base, Two-Tone Casters
- P Plastic Std. Base, Two-Tone Casters
- R Aluminum Low Base, Two-Tone Casters
- T Aluminum Std. Base, Two-Tone Casters

- 2) Fabric surface and color (seat).
- 3) Fabric surface and color (back).
- 4) Shell color – required for upholstered and non-upholstered.
- 5) Trim for arm caps, plastic components and base (plastic base only).
- 6) Trim color for aluminum components (aluminum base, control housing, and frame).

Polished Aluminum (PM-P) add **\$186.77** list.

To Order, Specify:

- 1) Product number, including;

1 Seat or Seat Pad Option:

- 1 Leather
- 2 Fabric
- 3 Faux Leather
- 4 Polymer

2 Back or Back Pad Option:

- 1 Leather
- 2 Fabric
- 3 Faux Leather
- 4 Polymer

Number 1 2 3	Price	Fabric Grade		C	D	E	F	G	H	Leather Grade A	Leather Grade B
		A	B								
Polymer Shell - Aluminum Base Without Optional Upholstered Pad											
SCC- 4 4 -1	\$932.62	N/A	N/A	N/A	N/A	N/A	N/A	N/A	N/A	N/A	N/A
Polymer Shell - Aluminum Base With Upholstered Seat Pad											
SCC- 4 4 -1 E	N/A	\$1057.07	\$1092.01	\$1129.38	\$1146.24	\$1161.89	\$1193.23	\$1223.35	\$1302.89	\$1218.53	\$1362.94
Polymer Shell - Aluminum Base With Upholstered Seat and Back Pads											
SCC- 4 4 -1 E	N/A	\$1144.57	\$1214.45	\$1289.19	\$1322.91	\$1354.21	\$1416.89	\$1477.13	\$1636.21	\$1467.49	\$1756.31
Number 1 2 3	Price	Fabric Grade		C	D	E	F	G	H	Leather Grade A	Leather Grade B
		A	B								
Polymer Shell - Plastic Base Without Optional Upholstered Pad											
SCC- 4 4 -1	\$808.52	N/A	N/A	N/A	N/A	N/A	N/A	N/A	N/A	N/A	N/A
Polymer Shell - Plastic Base With Upholstered Seat Pad											
SCC- 4 4 -1 E	N/A	\$ 932.97	\$ 967.91	\$1005.28	\$1022.14	\$1037.79	\$1069.13	\$1099.25	\$1178.79	\$1094.43	\$1238.84
Polymer Shell - Plastic Base With Upholstered Seat and Back Pads											
SCC- 4 4 -1 E	N/A	\$1020.47	\$1090.35	\$1165.09	\$1198.81	\$1230.11	\$1292.79	\$1353.03	\$1512.11	\$1343.39	\$1632.21

The following options require modification of the product number.

- CAL 133
Stain repellent

To specify, add **F** to the end of the product number; **Example:** SCC-22-11EF (add **\$68.68** list)
To specify, add **P** to end of the product number (add **\$37.35** list)

NOTE: CAL 133 is available on SCC-22 or SCC-33 fully upholstered fabric or faux leather models only.

Stain repellent is available on SCC-22 and SCC-24 models only.

For available fabrics, refer to surfaces.haworth.com.

Very

Conference Chair - Perforated

Without Arms



SCC-44-01

Dimensions

- SH: 15.5"(394mm)-20.5"(521mm)*
- Low position base: SH: 10.4"(264mm)-14.4"(366mm)*
- H: 36.9"(937mm)
- D: 26.7"(678mm)
- W: 21.8"(554mm)
- SW: 19.2"(487mm)*
- SD: 17.5"(443mm)*
- Low position base: SH: 14.4"(366mm)-19.4"(493mm)*

* All measurements taken with the BIFMA chair measuring device.

Features

- Back: High-strength polymer with flexing perforations and an optional upholstered foam pad.
- Seat: High-strength polymer with an optional upholstered foam pad.
- Upholstered seat features 1"(25.4mm) foam pad.
- Upholstered back features 0.5"(12.7mm) foam pad.
- Base: Standard five-star all aluminum or all plastic base. Optional low-base range 14.4"(366mm)-19.4"(493mm).
- 5"(127mm) height adjustment.
- Weight assisted recline mechanism.
- Casters: Hard (black), soft (black) or two-tone (fog and gray).
- Back tilts backward 14° from the upright position. Additional recline achieved in flexible back.
- Painted or optional polished aluminum.
- COM yardage / COL square footage:
Fully Upholstered: 1.5/17
Upholstered seat: 0.75/9.5

To Order, Specify (cont'd):

3 Base/Caster Option:

Aluminum Base

- 1** Aluminum Std. Base, Hard Caster
- 2** Aluminum Std. Base, Soft Caster
- 3** Aluminum Low Base, Hard Caster
- 4** Aluminum Low Base, Soft Caster

Plastic Base

- 5** Plastic Std. Base, Hard Caster
- 6** Plastic Std. Base, Soft Caster
- 7** Plastic Low Base, Hard Caster
- 8** Plastic Low Base, Soft Caster

Two-Tone Casters

- N** Plastic Low Base, Two-Tone Casters
- P** Plastic Std. Base, Two-Tone Casters
- R** Aluminum Low Base, Two-Tone Casters
- T** Aluminum Std. Base, Two-Tone Casters

- 2) Fabric surface and color (seat).
- 3) Fabric surface and color (back).
- 4) Shell color – required for upholstered and non-upholstered.
- 5) Trim for plastic components and base (plastic base only).
- 6) Trim color for aluminum components (aluminum base, control housing, and frame).

Polished Aluminum (PM-P) add **\$186.77** list.

To Order, Specify:

1) Product number, including;

1 Seat or Seat Pad Option:

- 1** Leather
- 2** Fabric
- 3** Faux Leather
- 4** Polymer

2 Back or Back Pad Option:

- 1** Leather
- 2** Fabric
- 3** Faux Leather
- 4** Polymer

Number 1 2 3	Price	Fabric Grade		C	D	E	F	G	H	Leather Grade A	Leather Grade B
		A	B								
Polymer Shell - Aluminum Base Without Optional Upholstered Pad											
SCC- 4 4 -0	\$857.91	N/A	N/A	N/A	N/A	N/A	N/A	N/A	N/A	N/A	N/A
Polymer Shell - Aluminum Base With Upholstered Seat Pad											
SCC- 4 4 -0 E	N/A	\$ 982.36	\$1017.30	\$1054.67	\$1071.53	\$1087.18	\$1118.52	\$1148.64	\$1228.18	\$1143.82	\$1288.23
Polymer Shell - Aluminum Base With Upholstered Seat and Back Pads											
SCC- 4 4 -0 E	N/A	\$1069.86	\$1139.74	\$1214.48	\$1248.20	\$1279.50	\$1342.18	\$1402.42	\$1561.50	\$1392.78	\$1681.60

Number 1 2 3	Price	Fabric Grade		C	D	E	F	G	H	Leather Grade A	Leather Grade B
		A	B								
Polymer Shell - Plastic Base Without Optional Upholstered Pad											
SCC- 4 4 -0	\$733.81	N/A	N/A	N/A	N/A	N/A	N/A	N/A	N/A	N/A	N/A
Polymer Shell - Plastic Base With Upholstered Seat Pad											
SCC- 4 4 -0 E	N/A	\$858.26	\$ 893.20	\$ 930.57	\$ 947.43	\$ 963.08	\$ 994.42	\$1024.54	\$1104.08	\$1019.72	\$1164.13
Polymer Shell - Plastic Base With Upholstered Seat and Back Pads											
SCC- 4 4 -0 E	N/A	\$945.76	\$1015.64	\$1090.38	\$1124.10	\$1155.40	\$1218.08	\$1278.32	\$1437.40	\$1268.68	\$1557.50

The following options require modification of the product number.

CAL 133
Stain repellent

To specify, add **F** to the end of the product number; **Example:** SCC-22-01EF (add **\$68.68** list)
To specify, add **P** to end of the product number (add **\$37.35** list)

NOTE: CAL 133 is available on SCC-22 or SCC-33 fully upholstered fabric or faux leather models only.

Stain repellent is available on SCC-22 and SCC-24 models only.

For available fabrics, refer to surfaces.haworth.com.

Very

Conference Stool – Perforated Back



SCF-44-11



SCF-44-01

Dimensions

SH: 23"-32"
(584mm-813mm)
W: 25"(635mm)
D: 26.7"(678mm)
SW: 18.75"(477mm)
SD: 17.2"(434mm)
AH: 8.7"(221mm)

Between Arms:
20.8"(528mm)

Features

- Back: High-strength polymer back with flexing perforations and an optional upholstery pad.
- Seat: High-strength polymer seat with an optional upholstery pad.
- Weight assisted recline mechanism.
- Upholstered seat features 1"(25.4mm) foam pad.
- Upholstered back features 0.5"(12.7mm) foam pad.
- Arms: Black or Fog hard arm caps.
- Base: Standard five-star all aluminum or all plastic base.
- Footring: Brushed Aluminum finish.
- Adjustable footring: adjusts 4"(102mm) up and down.
- Casters: Standard with hard casters, black or two-tone.
- Optional black soft casters.
- COM yardage / COL square footage:
Fully Upholstered: 1.5/13
Upholstered seat: .75/7.25

To Order, Specify:

1) Product number.

1 Seat or Seat Pad Option:

- 1 Leather
- 2 Fabric
- 3 Faux Leather
- 4 Polymer

2 Back or Back Pad Option:

- 1 Leather
- 2 Fabric
- 3 Faux Leather
- 4 Perforated Polymer

3 Arm or Cap Option:

- 0 No Arms
- 1 Fixed Arm, Hard Caps, add \$149.42 list

4 Base or Caster Option:

Aluminum Base

- 1 Aluminum Std. Base, Hard Casters
- 2 Aluminum Std. Base, Soft Casters
- T Aluminum Std. Base, Two-Tone Casters

Plastic Base

- 5 Plastic Std. Base, Hard Casters
- 6 Plastic Std. Base, Soft Casters
- P Plastic Std. Base, Two-Tone Casters

- 2) Fabric surface and color (seat).
- 3) Fabric surface and color (back).
- 4) Shell color - required for upholstered and non-upholstered.
- 5) Trim for arm caps (if specified). (base if plastic is specified above).
- 6) Frame trim color- Aluminum components (base if aluminum and arm uprights).

Description	Number				Price	Fabric Grade								Leather Grade A	Leather Grade B
	1	2	3	4		A	B	C	D	E	F	G	H		
Aluminum Base Without Optional Upholstered Pad															
SCF- 4 4 -					\$1210.96	N/A	N/A	N/A	N/A	N/A	N/A	N/A	N/A	N/A	
Aluminum Base With Upholstered Seat Pad															
SCF- 4 -				E	N/A	\$1335.41	\$1370.35	\$1407.72	\$1424.58	\$1440.23	\$1471.57	\$1501.69	\$1581.23	\$1496.87	\$1641.28
Aluminum Base With Upholstered Seat and Back Pads															
SCF- -				E	N/A	\$1422.91	\$1492.79	\$1567.53	\$1601.25	\$1632.55	\$1695.23	\$1755.47	\$1914.55	\$1745.83	\$2034.65
Plastic Base Without Optional Upholstered Pad															
SCF- 4 4 -					\$1086.86	N/A	N/A	N/A	N/A	N/A	N/A	N/A	N/A	N/A	
Plastic Base With Upholstered Seat Pad															
SCF- 4 -				E	N/A	\$1211.31	\$1246.25	\$1283.62	\$1300.48	\$1316.13	\$1347.47	\$1377.59	\$1457.13	\$1372.77	\$1517.18
Plastic Base With Upholstered Seat and Back Pads															
SCF- -				E	N/A	\$1298.81	\$1368.69	\$1443.43	\$1477.15	\$1508.45	\$1571.13	\$1631.37	\$1790.45	\$1621.73	\$1910.55

The following options require modification of the product number.

Stain repellent

To specify, add **P** to end of the product number; **Example:** SCF-22-01EP (add \$37.35 list)

Very Tetro Back Side, Seminar Chair and Side Stool

General Specifications

**Features and Options
(Side Chair, Seminar Chair and Side Stool)**

Side and Seminar Chair

- Back: High-strength polymer back with injection molded technology
- Seat: High-strength polymer seat with an optional upholstered foam pad
- Casters: Hard (black), soft (black) or two-tone (fog and gray)
- Glides: Plastic or felt
- Frame finishes include: painted or trivalent chrome
- Weight assisted recline mechanism (Seminar model only)
- Fog or black trim arm caps and glides available
- Arm or armless version available
- Stacks 5-high on the floor or 8-high (71.75" high by 48.25" wide by 25.5" deep) on cart

Side Stool

- Back: High-strength polymer back with injection molded technology
- Seat: High-strength polymer seat with an optional upholstered foam pad
- Glides: Plastic or felt
- Frame finishes include: painted or trivalent chrome
- Fog or black trim arm caps and glides available
- Arm or armless version available
- Stacks 5-high on the floor

**General Guidelines for
Product Specification**

Side and Seminar

	<u>S</u>	<u>C</u>	<u>M</u>	-	<u>2</u>	<u>5</u>	-	<u>3</u>	<u>1</u>	<u>E</u>	<u>3A-18</u>	<u>TR-FA</u>	<u>TR-F</u>	<u>TR-LE</u>	
Product Type	_____														
(S) Seating	_____														
Product Line	_____														
(C) Very	_____														
Model	_____														
(M) Seminar	_____														
(S) Side	_____														
(L) Side Stool	_____														
Seat Upholstery	_____														
(1) Leather	_____														
(2) Fabric	_____														
(3) Faux Leather	_____														
(4) Polymer	_____														
Back	_____														
(5) Tetro Back	_____														
Arm/Caps	_____														
(0) No Arms	_____														
(3) Fixed Arms, Hard Caps	_____														
Base/Caster	_____														
(H) 4-Leg, Plastic Glides	_____														
(K) 4-Leg, Felt Glides	_____														
(1) 4-Leg, Hard Casters*	_____														
(2) 4-Leg, Soft Casters*	_____														
(T) 4-Leg, Two-Tone Casters*	_____														
Enhanced Upholstery	_____														
Seat Upholstery	_____														
Tellure	_____														
Shell Color	_____														
Tomato	_____														
Trim Color	_____														
Black	_____														
Frame Trim Color	_____														
Metallic Silver	_____														

*Side and Seminar chairs only

Very

Side Chair – Tetro Back

With Arms



SCS-45-3H

Dimensions

SH: 18.2"(461mm)*
 H: 33.9"(861mm)
 D: 22"(559mm)
 W: 23.5"(597mm)
 SW: 19.2"(487mm)*
 SD: 17.5"(443mm)*
 AH: 8.9"(226mm)*
 Between Arms:
 19.6"(498mm)

Features

- Back: High-strength polymer back with injection molded technology.
- Seat: High-strength polymer seat with an optional upholstery pad.
- Upholstered seat features 1"(25.4mm) foam pad.
- Arms: Black or Fog glass-filled polypropylene arm caps.
- Frame: available painted or trivalent chrome.
- Casters: Hard (black), soft (black) or two-tone (fog and gray).
- Glides: Plastic or felt.
- Stacks 5 high on the floor and 8 high on a cart
- COM yardage / COL square footage:
 Upholstered seat: .75/ 7.25

*All measurements taken with the BIFMA chair measuring device.

To Order, Specify:

1) Product number, including;

1 Seat or Seat Pad Option:

- 1 Leather
- 2 Fabric
- 3 Faux Leather
- 4 Polymer

2 Glide or Caster Option:

- H Plastic Glide
- K Felt Glide
- 1 Hard Casters, add **\$43.38** list
- 2 Soft Casters, add **\$43.38** list
- T Two-Tone Casters, add **\$43.38** list

2) Fabric surface and color (seat).

3) Shell color – required for upholstered and non-upholstered.

4) Trim for arm caps, glides and plastic components.

5) Frame trim color.

Trivalent Chrome (KR-V) add **\$186.77** list.

Number ① ②	Price	Fabric Grade		C	D	E	F	G	H	Leather Grade A	Leather Grade B
		A	B								
Tetro Back Without Optional Upholstered Pad											
SCS- 4 5 -3 ■	\$334.97	N/A	N/A	N/A	N/A	N/A	N/A	N/A	N/A	N/A	N/A
Tetro Back With Upholstered Seat Pad											
SCS- ■ 5 -3 ■ E	N/A	\$415.64	\$450.58	\$487.95	\$504.81	\$520.46	\$551.80	\$581.92	\$661.46	\$577.10	\$721.51

The following options require modification of the product number.

Stain repellent

To specify, add **P** to end of the product number; **Example:** SCS-25-3HEP (add **\$37.35** list)

Very

Side Chair – Tetro Back

Without Arms



SCS-45-0H

Dimensions

- SH: 18.2"(461mm)*
- H: 33.9"(861mm)
- D: 22"(559mm)
- W: 22.3"(566mm)
- SW: 19.2"(487mm)*
- SD: 17.5"(443mm)*

Features

- Back: High-strength polymer back with injection molded technology.
- Seat: High-strength polymer seat with an optional upholstery pad.
- Upholstered seat features 1"(25.4mm) foam pad.
- Frame: available painted or trivalent chrome.
- Casters: Hard (black), soft (black) or two-tone (fog and gray).
- Glides: Plastic or felt.
- Stacks 5 high on the floor and 8 high on a cart
- COM yardage / COL square footage:
Upholstered seat: .75/ 7.25

*All measurements taken with the BIFMA chair measuring device.

To Order, Specify:

1) Product number, including;

1 Seat or Seat Pad Option:

- 1** Leather
- 2** Fabric
- 3** Faux Leather
- 4** Polymer

2 Glide or Caster Option:

- H** Plastic Glide
- K** Felt Glide
- 1** Hard Casters, add **\$43.38** list
- 2** Soft Casters, add **\$43.38** list
- T** Two-Tone Casters, add **\$43.38** list

- 2) Fabric surface and color (seat).
- 3) Shell color – required for upholstered and non-upholstered.
- 4) Add glide and plastic component trim color.
- 5) Frame trim color.
Trivalent Chrome (KR-V) add **\$186.77** list.

Number ① ②	Price	Fabric Grade		C	D	E	F	G	H	Leather Grade A	Leather Grade B
		A	B								
Tetro Back Without Optional Upholstered Pad											
SCS- 4 5 -0	\$272.32	N/A	N/A	N/A	N/A	N/A	N/A	N/A	N/A	N/A	N/A
Tetro Back With Upholstered Seat Pad											
SCS- 5 -0 E	N/A	\$352.99	\$387.93	\$425.30	\$442.16	\$457.81	\$489.15	\$519.27	\$598.81	\$514.45	\$658.86

The following options require modification of the product number.

Stain repellent

To specify, add **P** to end of the product number; **Example:** SCS-25-0HEP (add **\$37.35** list)

Very

Side Chair with Tablet Arm – Tetro Back

Side With Tablet Arm



SCS-45-RH

Dimensions

- SH: 18.2"(461mm)
- H: 33.9"(861mm)
- W: 23.5"(597mm)
- D: 22"(559mm)
- SW: 19.2"(487mm)
- SD: 17.5"(443mm)

Features

- Back: High-strength polymer back with injection molded technology.
- Seat: High-strength polymer with an optional upholstery pad.
- Upholstered seat features 1"(25.4mm) foam pad.
- Arm cap: Black.
- Tablet assembly painted black.
- Flips up and fold away laminate tablet with matching laminate underside.
- Left or right-hand configurations.
- Tablet arm size: 15"W x 9.8"D (Sized to accommodate laptops).
- Clearance from tablet to chair back 12.5"(318mm)-15.5"(394mm) angled.
- Base: available painted or optional trivalent chrome.
- Glides or Casters.
- Standard with hard casters, black or two-tone.
- Optional black soft casters.
- COM yardage / COL square footage:
Fully Upholstered: 1.5/13
Upholstered seat: .75/7.25

*All measurements taken with the BIFMA chair measuring device.

To Order, Specify:

1) Product number.

1 Seat or Seat Pad Option:

- 1 Leather
- 2 Fabric
- 3 Faux Leather
- 4 Polymer

2 Arm or Tablet Option:

- R Right-Hand Tablet Arm
- L Left-Hand Tablet Arm

3 Glide or Caster Option:

- H Plastic Glide
- K Felt Glide
- 1 Hard Casters, add **\$43.38** list
- 2 Soft Casters, add **\$43.38** list
- T Two-Tone Casters, add **\$43.38** list

- 2) Fabric surface and color (seat).
- 3) Shell color - required for upholstered and non-upholstered.
- 4) Glide and plastic component trim color.
- 5) Frame trim color.
- Trivalent Chrome (KR-V) add **\$186.77** list.
- 6) Laminate for tablet (if specified).

Description	Number			Price	Fabric Grade		C	D	E	F	G	H	Leather Grade A	Leather Grade B
	1	2	3		A	B								
Tetro Back Without Optional Upholstered Pad														
SCS- 4 5- ■ ■				\$483.18	N/A	N/A	N/A	N/A	N/A	N/A	N/A	N/A	N/A	N/A
Tetro Back With Upholstered Seat Pad														
SCS- ■ 5- ■ ■ E				N/A	\$563.85	\$598.79	\$636.16	\$653.02	\$668.67	\$700.01	\$730.13	\$809.67	\$725.31	\$869.72

The following options require modification of the product number.

Stain repellent

To specify, add **P** to end of the product number; **Example:** SCS-25-RHEP (add **\$37.35** list)

Very

Side Chair with Storage Rack – Tetro Back



SCK-45-3H

Dimensions

- SH: 18.2"(461mm)*
- H: 33.9"(861mm)
- W: 23.5"(597mm)
- D: 22"(559mm)
- SW: 19.2"(487mm)*
- SD: 17.5"(443mm)*
- AH: 8.9"(226mm)*

Between Arms:
19.6"(498mm)

Features

- Back: High-strength polymer back with injection molded technology.
- Seat: Injection-molded high-strength polymer seat with an optional upholstery pad.
- Upholstered seat features 1"(25.4mm) foam pad.
- Storage rack ships unassembled (chrome only).
- Arms: Black or Fog arm caps when no tablet is specified.
- Optional Tablet arm:
 - Tablet assembly painted black.
 - Flips up and fold away laminate tablet with matching laminate underside.
 - Left or right-hand configurations.
 - Tablet arm size: 15"W x 9.8"D (Sized to accommodate laptops).
- Base: available painted or optional trivalent chrome.
- Glides or Casters: Standard with hard casters, black or two-tone.
- Optional black soft casters.
- COM yardage / COL square footage:
 - Fully Upholstered: 1.5/13
 - Upholstered seat: .75/7.25

*All measurements taken with the BIFMA chair measuring device.

To Order, Specify:

1) Product number.

1 Seat or Seat Pad Option:

- 1 Leather
- 2 Fabric
- 3 Faux Leather
- 4 Polymer

2 Arm or Cap Option:

- 0 No Arms
- 3 Fixed Arm, Hard Caps, add \$62.65 list

3 Glide or Caster Option:

- H Plastic Glide
- K Felt Glide
- 1 Hard Casters, add \$43.38 list
- 2 Soft Casters, add \$43.38 list
- T Two-Tone Casters, add \$43.38 list

- 2) Fabric surface and color (seat).
- 3) Shell color - required for upholstered and non-upholstered.
- 4) Trim for arm caps (if specified) and glides.
- 5) Frame trim color.
Trivalent Chrome (KR-V) add \$186.77 list.
- 6) Laminate for tablet (if specified).

Description	Number			Price	Fabric Grade						Leather Grade A	Leather Grade B		
	1	2	3		A	B	C	D	E	F			G	H
Tetro Back Without Optional Upholstered Pad														
SCK- 4 5-	■	■		\$350.63	N/A	N/A	N/A	N/A	N/A	N/A	N/A	N/A	N/A	
Tetro Back With Upholstered Seat Pad														
SCK- 5-	■	■	E	N/A	\$431.30	\$466.24	\$503.61	\$520.47	\$536.12	\$567.46	\$597.58	\$677.12	\$592.76	\$737.17

The following options require modification of the product number.

Stain repellent

To specify, add **P** to end of the product number; **Example:** SCK-25-0HEP (add \$37.35 list)

Very

Bar Height Side Stool – Tetro Back

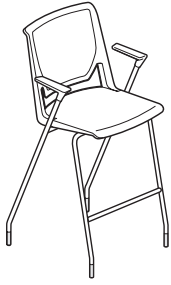

SCL-45-3H

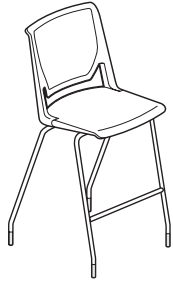

SCL-45-0H

Dimensions

SH: 29.75"(756mm)
 H: 46.25"(1175mm)
 W: 23.75"(604mm)
 D: 23"(587mm)
 SW: 18.75"(477mm)
 SD: 17.2"(434mm)
 AH: 8.9"(226mm)

Between Arms:
 19.6"(498mm)

Features

- Back: High-strength polymer back with injection molded technology.
- Seat: High-strength polymer seat with an optional upholstery pad.
- Upholstered seat features 1"(25.4mm) foam pad.
- Arms: Black or Fog high-strength polymer arm caps.
- Base: available painted or optional trivalent chrome.
- Stacks 5 high on the floor.
- Standard with glides, Black or Fog.
- COM yardage / COL square footage:
 Fully Upholstered: 1.5/13
 Upholstered seat: .75/7.25

To Order, Specify:

1) Product number.

1 Seat or Seat Pad Option:

- 1 Leather
- 2 Fabric
- 3 Faux Leather
- 4 Polymer

2 Glide Option:

- H Plastic Glide
- K Felt Glide

2) Fabric surface and color (seat).

3) Shell color - required for upholstered and non-upholstered.

4) Trim for arm caps (if specified) and glides.

5) Frame trim color.

Trivalent Chrome (KR-V) add **\$186.77** list.

Description	Number		Price	Fabric Grade							Leather Grade A	Leather Grade B	
	1	2		A	B	C	D	E	F	G			H
Tetro Back Without Optional Upholstered Pad													
With Arms	SCL- 4	5-3	\$695.25	N/A	N/A	N/A	N/A	N/A	N/A	N/A	N/A	N/A	N/A
Without Arms	SCL- 4	5-0	632.60	N/A	N/A	N/A	N/A	N/A	N/A	N/A	N/A	N/A	N/A
Tetro Back With Upholstered Seat Pad													
With Arms	SCL-	5-3	N/A	\$775.92	\$810.86	\$848.23	\$865.09	\$880.74	\$912.08	\$942.20	\$1021.74	\$937.38	\$1081.79
Without Arms	SCL-	5-0	N/A	713.27	748.21	785.58	802.44	818.09	849.43	879.55	959.09	874.73	1019.14

The following options require modification of the product number.

Stain repellent

To specify, add **P** to end of the product number; **Example:** SCL-25-0HEP (add **\$37.35** list)

Very

Counter Height Side Stool – Tetro Back

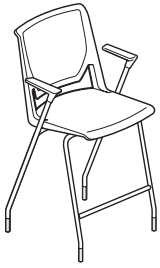

SCLC-45-3H

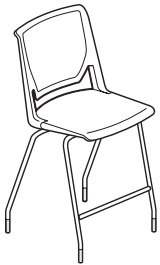

SCLC-45-0H

Dimensions

SH: 25.75"(654mm)
 H: 42.25"(1073mm)
 W: 23.75"(604mm)
 D: 21.7"(551mm)
 SW: 18.75"(477mm)
 SD: 17.2"(434mm)
 AH: 8.9"(226mm)

Between Arms:
 19.6"(498mm)

Features

- Back: High-strength polymer back with injection molded technology.
- Seat: High-strength polymer seat with an optional upholstery pad.
- Upholstered seat features 1"(25.4mm) foam pad.
- Arms: Black or Fog high-strength polymer arm caps.
- Base: available painted or optional trivalent chrome.
- Stacks 5 high on the floor.
- Standard with glides, Black or Fog.
- COM yardage / COL square footage:
 Fully Upholstered: 1.5/13
 Upholstered seat: .75/7.25

To Order, Specify:

1) Product number.

1 Seat or Seat Pad Option:

- 1 Leather
- 2 Fabric
- 3 Faux Leather
- 4 Polymer

2 Glide Option:

- H Plastic Glide
- K Felt Glide

- 2) Fabric surface and color (seat).
- 3) Shell color - required for upholstered and non-upholstered.
- 4) Trim for arm caps (if specified) and glides.
- 5) Frame trim color.
 Trivalent Chrome (KR-V) add **\$186.77** list.

Description	Number		Price	Fabric Grade								Leather Grade A	Leather Grade B
	1	2		A	B	C	D	E	F	G	H		
Tetro Back Without Optional Upholstered Pad													
With Arms	SCLC-	4 5-3	\$695.25	N/A	N/A	N/A	N/A	N/A	N/A	N/A	N/A	N/A	N/A
Without Arms	SCLC-	4 5-0	632.60	N/A	N/A	N/A	N/A	N/A	N/A	N/A	N/A	N/A	N/A
Tetro Back With Upholstered Seat Pad													
With Arms	SCLC-	5-3 E	N/A	\$775.92	\$810.86	\$848.23	\$865.09	\$880.74	\$912.08	\$942.20	\$1021.74	\$937.38	\$1081.79
Without Arms	SCLC-	5-0 E	N/A	713.27	748.21	785.58	802.44	818.09	849.43	879.55	959.09	874.73	1019.14

The following options require modification of the product number.

Stain repellent

To specify, add **P** to end of the product number; **Example:** SCLC-25-0HEP (add **\$37.35** list)

Very

Seminar Chair – Tetro Back

With Arms



SCM-45-3H

Dimensions

- SH: 18.2"(461mm)*
- H: 33.9"(861mm)
- D: 22"(559mm)
- W: 23.5"(597mm)
- SW: 19.2"(487mm)*
- SD: 17.5"(443mm)*
- AH: 8.9"(226mm)*
- Between Arms:
19.6"(498mm)

Features

- Back: High-strength polymer back with injection molded technology.
- Seat: High-strength polymer seat with an optional upholstery pad.
- Weight assisted recline mechanism.
- Upholstered seat features 1"(25.4mm) foam pad.
- Arms: Black or Fog glass-filled polypropylene arm caps.
- Frame: available painted or trivalent chrome.
- Casters: Hard (black), soft (black) or two-tone (fog and gray).
- Glides: Plastic or felt.
- Stacks 5 high on the floor and 8 high on a cart
- COM yardage / COL square footage:
Upholstered seat: .75/7.25

*All measurements taken with the BIFMA chair measuring device.

To Order, Specify:

1) Product number, including;

1 Seat or Seat Pad Option:

- 1 Leather
- 2 Fabric
- 3 Faux Leather
- 4 Polymer

2 Glide or Caster Option:

- H Plastic Glide
- K Felt Glide
- 1 Hard Casters, add **\$55.42** list
- 2 Soft Casters, add **\$55.42** list
- T Two-Tone Casters, add **\$55.42** list

2) Fabric surface and color (seat).

3) Shell color – required for upholstered and non-upholstered.

4) Trim for arm caps, glides, and plastic components.

5) Frame trim color.

Trivalent Chrome (KR-V) add **\$186.77** list.

Description	Number		Price	Fabric Grade		C	D	E	F	G	H	Leather Grade A	Leather Grade B
	1	2		A	B								
Tetro Back Without Optional Upholstered Pad													
SCM- 4 5 -3			\$577.16	N/A	N/A	N/A	N/A	N/A	N/A	N/A	N/A	N/A	N/A
Tetro Back With Upholstered Seat Pad													
SCM- 5 -3 E			N/A	\$679.44	\$714.38	\$751.75	\$768.61	\$784.26	\$815.60	\$845.72	\$925.26	\$840.90	\$985.31

The following options require modification of the product number.

Stain repellent

To specify, add **P** to end of the product number; **Example:** SCM-25-3HEP (add **\$37.35** list)

Very

Seminar Chair – Tetro Back

Without Arms



SCM-45-0H

Dimensions

- SH: 18.2"(461mm)*
- H: 33.9"(861mm)
- D: 22"(559mm)
- W: 22.3"(566mm)
- SW: 19.2"(487mm)*
- SD: 17.5"(443mm)*

Features

- Back: High-strength polymer back with injection molded technology.
- Seat: High-strength polymer seat with an optional upholstery pad.
- Weight assisted recline mechanism.
- Upholstered seat features 1"(25.4mm) foam pad.
- Arms: Black or Fog glass-filled polypropylene arm caps.
- Frame: available painted or trivalent chrome.
- Casters: Hard (black), soft (black) or two-tone (fog and gray).
- Glides: Plastic or felt.
- Stacks 5 high on the floor and 8 high on a cart
- COM yardage / COL square footage:
Upholstered seat: .75/7.25

*All measurements taken with the BIFMA chair measuring device.

To Order, Specify:

1) Product number, including;

1 Seat or Seat Pad Option:

- 1** Leather
- 2** Fabric
- 3** Faux Leather
- 4** Polymer

2 Glide or Caster Option:

- H** Plastic Glide
- K** Felt Glide
- 1** Hard Casters, add **\$55.42** list
- 2** Soft Casters, add **\$55.42** list
- T** Two-Tone Casters, add **\$55.42** list

- 2) Fabric surface and color (seat).
 - 3) Shell color – required for upholstered and non-upholstered.
 - 4) Glide and plastic component trim color.
 - 5) Frame trim color.
- Trivalent Chrome (KR-V) add **\$186.77** list.

Description	Number		Price	Fabric Grade								Leather Grade A	Leather Grade B
	1	2		A	B	C	D	E	F	G	H		
Tetro Back Without Optional Upholstered Pad													
	SCM- 4	5 -0	\$514.51	N/A	N/A	N/A	N/A	N/A	N/A	N/A	N/A	N/A	N/A
Tetro Back With Upholstered Seat Pad													
	SCM-	5 -0	N/A	\$616.79	\$651.73	\$689.10	\$705.96	\$721.61	\$752.95	\$783.07	\$862.61	\$778.25	\$922.66

The following options require modification of the product number.

Stain repellent

To specify, add **P** to end of the product number; **Example:** SCM-25-0HEP (add **\$37.35** list)

Very

Seminar with Tablet Arm – Tetro Back

Seminar With Tablet Arm



SCM-45-RH

Dimensions

- SH: 18.2"(461mm)*
- H: 33.9"(861mm)
- W: 23.5"(597mm)
- D: 22"(559mm)
- SW: 19.2"(487mm)*
- SD: 17.5"(443mm)*

Features

- Back: High-strength polymer back with injection molded technology.
- Seat: High-strength polymer with an optional upholstery pad.
- Weight assisted recline mechanism.
- Upholstered seat features 1"(25.4mm) foam pad.
- Arm caps: Black.
- Tablet assembly painted black.
- Clearance from tablet to chair back 12.5"(318mm)-15.5"(394mm) angled.
- Flips up and fold away laminate tablet with matching laminate underside.
- Left or right-hand configurations.
- Tablet arm size: 15"W x 9.8"D (Sized to accommodate laptops).
- Base: available painted or optional trivalent chrome.
- Glides or Casters.
- Standard with hard casters, black or two-tone.
- Optional black soft casters.
- COM yardage / COL square footage:
Fully Upholstered: 1.5/13
Upholstered seat: .75/7.25

*All measurements taken with the BIFMA chair measuring device.

To Order, Specify:

- 1) Product number.
- ❶ **Seat or Seat Pad Option:**
 - ❶ Leather
 - ❷ Fabric
 - ❸ Faux Leather
 - ❹ Polymer
- ❷ **Arm or Tablet Option:**
 - ❷ R Right-Hand Tablet Arm
 - ❷ L Left-Hand Tablet Arm
- ❸ **Glide or Caster Option:**
 - ❷ H Plastic Glide
 - ❷ K Felt Glide
 - ❷ 1 Hard Casters, add **\$55.42** list
 - ❷ 2 Soft Casters, add **\$55.42** list
 - ❷ T Two-Tone Casters, add **\$55.42** list
- 2) Fabric surface and color (seat).
- 3) Shell color - required for upholstered and non-upholstered.
- 4) Glide and plastic component trim color.
- 5) Frame trim color.
Trivalent Chrome (KR-V) add **\$186.77** list.
- 6) Laminate for tablet (if specified).

Description	Number			Price	Fabric Grade		C	D	E	F	G	H	Leather Grade A	Leather Grade B
	❶	❷	❸		A	B								
Tetro Back Without Optional Upholstered Pad														
SCM- 4 5-	■	■		\$725.37	N/A	N/A	N/A	N/A	N/A	N/A	N/A	N/A	N/A	N/A
Tetro Back With Upholstered Seat Pad														
SCM- 5-	■	■	E	N/A	\$827.65	\$862.59	\$899.96	\$916.82	\$932.47	\$963.81	\$993.93	\$1073.47	\$989.11	\$1133.52

The following options require modification of the product number.

Stain repellent

To specify, add **P** to end of the product number; **Example:** SCM-25-RHEP (add **\$37.35** list)

Very

Seminar with Storage Rack – Tetro Back

Seminar With Storage Rack

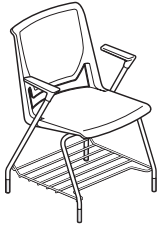

SCB-45-3H

Dimensions

- SH: 18.2"(461mm)*
- H: 33.9"(861mm)
- W: 23.5"(597mm)
- D: 22"(559mm)
- SW: 19.2"(487mm)*
- SD: 17.5"(443mm)*
- AH: 8.9"(226mm)*

Between Arms:
19.6"(498mm)

Features

- Back: High-strength polymer back with back with injection molded technology.
- Seat: High-strength polymer seat with an optional upholstery pad.
- Weight assisted recline mechanism.
- Upholstered seat features 1"(25.4mm) foam pad.
- Arms: Black or Fog arm caps.
- Storage rack available in Chrome only.
- Ships with chair, unassembled.
- Tablet assembly painted black.
- Flips up and fold away laminate tablet with matching laminate underside.
- Left or right-hand configurations.
- Tablet arm size: 15"W x 9.8"D (Sized to accommodate laptops).
- Base: available painted or optional trivalent chrome.
- Glides or Casters: Standard with hard casters, black or two-tone.
- Optional black soft casters.
- Weight: COM yardage / COL square footage:
Fully Upholstered: 1.5/13
Upholstered seat: .75/7.25

*All measurements taken with the BIFMA chair measuring device.

To Order, Specify:

1) Product number.

1 Seat or Seat Pad Option:

- 1 Leather
- 2 Fabric
- 3 Faux Leather
- 4 Polymer

2 Arm or Cap Option:

- 0 No Arms
- 3 Fixed Arm, Hard Caps, add **\$62.65** list

3 Glide or Caster Option:

- H Plastic Glide
- K Felt Glide
- 1 Hard Casters, add **\$55.42** list
- 2 Soft Casters, add **\$55.42** list
- T Two-Tone Casters, add **\$55.42** list

- 2) Fabric surface and color (seat).
- 3) Shell color - required for upholstered and non-upholstered.
- 4) Trim for arm caps (if specified) and glides.
- 5) Frame trim color.
Trivalent Chrome (KR-V) add **\$186.77** list.
- 6) Laminate for tablet (if specified).

Description	Number			Price	Fabric Grade								Leather Grade A	Leather Grade B
	1	2	3		A	B	C	D	E	F	G	H		
Tetro Back Without Optional Upholstered Pad														
SCB- 4 5-	■	■		\$592.82	N/A	N/A	N/A	N/A	N/A	N/A	N/A	N/A	N/A	N/A
Tetro Back With Upholstered Seat Pad														
SCB- 5-	■	■	E	N/A	\$695.10	\$730.04	\$767.41	\$784.27	\$799.92	\$831.26	\$861.38	\$940.92	\$856.56	\$1000.97

The following options require modification of the product number.

Stain repellent

To specify, add **P** to end of the product number; **Example:** SCB-25-0HEP (add **\$37.35** list)

Very Tetro Back Conference Chair and Conference Stool

General Specifications

Features and Options (Conference Chair and Conference Stool)

- Back: High-strength polymer back with injection molded technology
- Seat: High-strength polymer seat with an optional upholstered foam pad
- Five-star base with casters: hard (black), soft (black) or two-tone (fog and gray)
- Base: painted aluminum, polished aluminum or plastic (fog or black)
- Frame finishes include: painted or polished aluminum
- Weight assisted recline mechanism
- Standard Pneumatic height adjustment
- Fog or black trim arm caps
- Arm or armless version available
- Adjustable footring in brushed aluminum (stool only)

General Guidelines for Product Specification

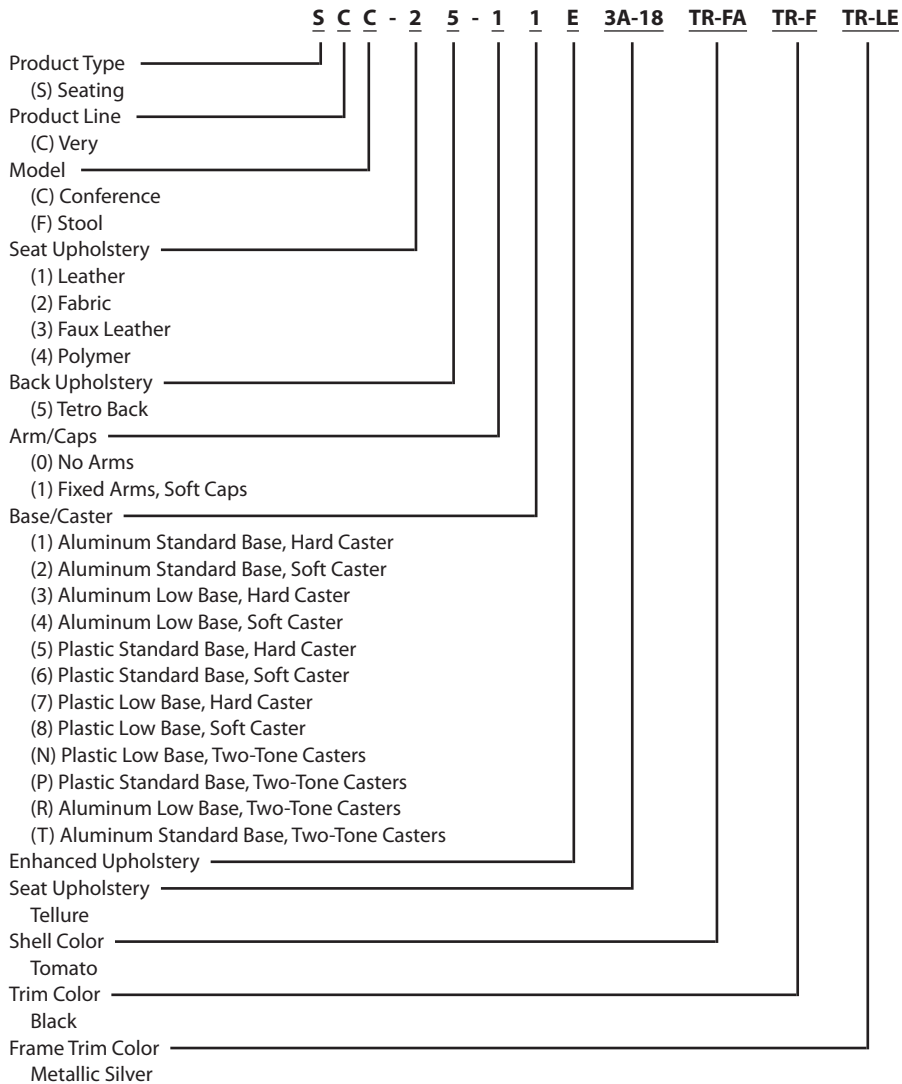

Very

Conference Chair - Tetro Back

With Arms



SCC-45-11

Dimensions

- SH: 15.5"(394mm)-20.5"(521mm)*
- H: 36.9"(937mm)
- D: 26.7"(678mm)
- W: 25"(635mm)
- SW: 19.2"(487mm)*
- SD: 17.5"(443mm)*
- AH: 8.7"(220mm)*
- Between Arms: 20.8"(528mm)

Features

- Back: High-strength polymer with injection molded technology.
- Seat: High-strength polymer with an optional upholstered foam pad.
- Upholstered seat features 1"(25.4mm) foam pad.
- Arms: Black or Fog glass-filled polypropylene soft arm caps.
- Base: Standard five-star all aluminum or all plastic base. Optional low-base range 14.4"(366mm)-19.4(493mm).
- 5"(127mm) height adjustment.
- Weight assisted recline mechanism.
- Casters: Hard (black), soft (black) or two-tone (fog and gray).
- Back tilts backward 14° from the upright position. Additional recline achieved in flexible back.
- Painted or optional polished aluminum.
- COM yardage / COL square footage:
Upholstered seat: .75/7.25

*All measurements taken with the BIFMA chair measuring device.

To Order, Specify:

1) Product number, including;

1 Seat or Seat Pad Option:

- 1 Leather
- 2 Fabric
- 3 Faux Leather
- 4 Polymer

2 Base/Caster Option:

Aluminum Base

- 1 Aluminum Std. Base, Hard Caster
- 2 Aluminum Std. Base, Soft Caster
- 3 Aluminum Low Base, Hard Caster
- 4 Aluminum Low Base, Soft Caster

Plastic Base

- 5 Plastic Std. Base, Hard Caster
- 6 Plastic Std. Base, Soft Caster
- 7 Plastic Low Base, Hard Caster
- 8 Plastic Low Base, Soft Caster

Two-Tone Casters

- N Plastic Low Base, Two-Tone Casters
- P Plastic Std. Base, Two-Tone Casters
- R Aluminum Low Base, Two-Tone Casters
- T Aluminum Std. Base, Two-Tone Casters

- 2) Fabric surface and color (seat).
- 3) Shell color – required for upholstered and non-upholstered.
- 4) Trim for arm caps, plastic components and base (plastic base only).
- 5) Trim color for frame, aluminum base and control housing.

Polished Aluminum (PM-P) add **\$186.77** list.

Tetro Back - Aluminum Base	Number		Price	Fabric Grade								Leather Grade A	Leather Grade B	
	1	2		A	B	C	D	E	F	G	H			
Without Optional Upholstered Pad														
	SCC- 4	5 -1	\$932.62	N/A	N/A	N/A	N/A	N/A	N/A	N/A	N/A	N/A	N/A	N/A
With Upholstered Seat Pad														
	SCC-	5 -1	E	N/A	\$1057.07	\$1092.01	\$1129.38	\$1146.24	\$1161.89	\$1193.23	\$1223.35	\$1302.89	\$1218.53	\$1362.94

Tetro Back - Plastic Base	Number		Price	Fabric Grade								Leather Grade A	Leather Grade B	
	1	2		A	B	C	D	E	F	G	H			
Without Optional Upholstered Pad														
	SCC- 4	5 -1	\$808.52	N/A	N/A	N/A	N/A	N/A	N/A	N/A	N/A	N/A	N/A	N/A
With Upholstered Seat Pad														
	SCC-	5 -1	E	N/A	\$932.97	\$967.91	\$1005.28	\$1022.14	\$1037.79	\$1069.13	\$1099.25	\$1178.79	\$1094.43	\$1238.84

The following options require modification of the product number.
 Stain repellent To specify, add **P** to end of the product number; **Example:** SCC-25-11EP (add **\$37.35** list)

Very

Conference Chair - Tetro Back

Without Arms



SCC-45-01

Dimensions

- SH: 15.5"(394mm)-20.5"(521mm)*
- H: 36.9"(937mm)
- D: 26.7"(678mm)
- W: 19.4"(493mm)
- SW: 19.2"(487mm)*
- SD: 17.5"(443mm)*

Features

- Back: High-strength polymer with injection molded technology.
- Seat: High-strength polymer with an optional upholstered foam pad.
- Upholstered seat features 1"(25.4mm) foam pad.
- Base: Standard five-star all aluminum or all plastic base. Optional low-base range 14.4"(366mm)-19.4(493mm)
- 5"(127mm) height adjustment.
- Weight assisted recline mechanism.
- Casters: Hard (black), soft (black) or two-tone (fog and gray).
- Back tilts backward 14° from the upright position. Additional recline achieved in flexible back.
- Painted or optional polished aluminum.
- COM yardage / COL square footage:
Upholstered seat: .75/7.25

*All measurements taken with the BIFMA chair measuring device.

To Order, Specify:

1) Product number, including;

1 Seat or Seat Pad Option:

- 1 Leather
- 2 Fabric
- 3 Faux Leather
- 4 Polymer

2 Base/Caster Option:

Aluminum Base

- 1 Aluminum Std. Base, Hard Caster
- 2 Aluminum Std. Base, Soft Caster
- 3 Aluminum Low Base, Hard Caster
- 4 Aluminum Low Base, Soft Caster

Plastic Base

- 5 Plastic Std. Base, Hard Caster
- 6 Plastic Std. Base, Soft Caster
- 7 Plastic Low Base, Hard Caster
- 8 Plastic Low Base, Soft Caster

Two-Tone Casters

- N Plastic Low Base, Two-Tone Casters
- P Plastic Std. Base, Two-Tone Casters
- R Aluminum Low Base, Two-Tone Casters
- T Aluminum Std. Base, Two-Tone Casters

2) Fabric surface and color (seat).

3) Shell color – required for upholstered and non-upholstered.

4) Trim for arm caps, plastic components and base (plastic base only).

5) Trim color for frame, aluminum base and control housing.

Polished Aluminum (PM-P) add **\$186.77** list.

Tetro Back - Aluminum Base	Number		Price	Fabric Grade								Leather Grade A	Leather Grade B	
	1	2		A	B	C	D	E	F	G	H			
Without Optional Upholstered Pad														
	SCC- 4	5 -0	\$857.91	N/A	N/A	N/A	N/A	N/A	N/A	N/A	N/A	N/A	N/A	N/A
With Upholstered Seat Pad														
	SCC-	5 -0	N/A	\$982.36	\$1017.30	\$1054.67	\$1071.53	\$1087.18	\$1118.52	\$1148.64	\$1228.18	\$1143.82	\$1288.23	

Tetro Back - Plastic Base	Number		Price	Fabric Grade								Leather Grade A	Leather Grade B	
	1	2		A	B	C	D	E	F	G	H			
Without Optional Upholstered Pad														
	SCC- 4	5 -0	\$733.81	N/A	N/A	N/A	N/A	N/A	N/A	N/A	N/A	N/A	N/A	N/A
With Upholstered Seat Pad														
	SCC-	5 -0	N/A	\$858.26	\$893.20	\$930.57	\$947.43	\$963.08	\$994.42	\$1024.54	\$1104.08	\$1019.72	\$1164.13	

The following options require modification of the product number.

Stain repellent

To specify, add **P** to end of the product number; **Example:** SCC-25-01EP (add **\$37.35** list)

Very

Conference Stool – Tetro Back



SCF-45-11



SCF-45-01

Dimensions

SH: 23"-32"
(584mm-813mm)
W: 25"(635mm)
D: 26.7"(678mm)
SW: 18.7"(477mm)
SD: 17.2"(434mm)
AH: 8.7"(221mm)

Between Arms:
20.8"(528mm)

Features

- Back: High-strength polymer with injection molded technology.
- Seat: High-strength polymer with an optional upholstered foam pad.
- Weight assisted recline mechanism.
- Upholstered seat features 1"(25.4mm) foam pad.
- Arms: Black or Fog hard arm caps.
- Base: Standard five-star all aluminum or all plastic base.
- Footring: Brushed Aluminum finish.
- Adjustable footring: adjusts 4"(102mm) up and down.
- Casters: Standard with hard casters, black or two-tone.
- Optional black soft casters.
- COM yardage / COL square footage:
Fully Upholstered: 1.5/13
Upholstered seat: .75/7.25

To Order, Specify:

1) Product number.

1 Seat or Seat Pad Option:

- 1** Leather
- 2** Fabric
- 3** Faux Leather
- 4** Polymer

2 Arm or Cap Option:

- 0** No Arms
- 1** Fixed Arm, Hard Caps, add **\$149.42** list

3 Base or Caster Option:

Aluminum Base

- 1** Aluminum Std. Base, Hard Casters
- 2** Aluminum Std. Base, Soft Casters
- T** Aluminum Std. Base, Two-Tone Casters

Plastic Base

- 5** Plastic Std. Base, Hard Casters
- 6** Plastic Std. Base, Soft Casters
- P** Plastic Std. Base, Two-Tone Casters

- 2) Fabric surface and color (seat).
 - 3) Fabric surface and color (back).
 - 4) Shell color - required for upholstered and non-upholstered.
 - 5) Trim for arm caps (if specified). (base if plastic is specified above).
 - 6) Frame trim color- Aluminum components (base if aluminum and arm uprights).
- Polished Aluminum (PM-P) add **\$186.77** list.

Description	Number			Price	Fabric Grade								Leather Grade A	Leather Grade B
	1	2	3		A	B	C	D	E	F	G	H		
Aluminum Base Without Optional Upholstered Pad														
SCF- 4 5-	■	■		\$1210.96	N/A	N/A	N/A	N/A	N/A	N/A	N/A	N/A	N/A	N/A
Aluminum Base With Upholstered Seat Pad														
SCF- ■ 5-	■	■	E	N/A	\$1335.41	\$1370.35	\$1407.72	\$1424.58	\$1440.23	\$1471.57	\$1501.69	\$1581.23	\$1496.87	\$1641.28
Plastic Base Without Optional Upholstered Pad														
SCF- 4 5-	■	■		\$1086.86	N/A	N/A	N/A	N/A	N/A	N/A	N/A	N/A	N/A	N/A
Plastic Base With Upholstered Seat Pad														
SCF- ■ 5-	■	■	E	N/A	\$1211.31	\$1246.25	\$1283.62	\$1300.48	\$1316.13	\$1347.47	\$1377.59	\$1457.13	\$1372.77	\$1517.18

The following options require modification of the product number.
 Stain repellent To specify, add **P** to end of the product number; **Example:** SCF-25-11EP (add **\$37.35** list)

Very

Accessories

	Description	Number	Price
	Storage Rack	SCHR-1	\$78.31

SCHR-1
Class VY – SIN 711-18;
Discount Group XVIII

Features

- Chrome only.
- Recommended for use with Chrome chairs for durability and common finishes.
- Ships separate from chair (installation clips included).

To Order, Specify:

- 1) Product number.
(No finish specification required.)

	Right Tablet Arm	SCHA-R	\$168.69
	Left Tablet Arm	SCHA-L	\$168.69

SCHA-R
Class VY – SIN 711-18;
Discount Group XVIII

Features

- Ships unassembled.
- Flips up for access.
- Tablet assembly chrome.
- Clearance from tablet to chair back 12.5"(318mm)-15.5"(394mm) angled.
- Recommended for use with Chrome chairs for durability and common finishes.
- Laminate tablet with matching laminate underside.
- Tablet arm size: 15"W x 9.8"D (Sized to accommodate laptops).
- Left or right-hand configurations.

To Order, Specify:

- 1) Product number.
- 2) Laminate surface specification.

Note: Tool from 2474-7601 required for installation. Every order for 1-30 chairs will come with 1 installation tool (ie, a 90 chair order will come with 3 tools).

	Arm to Armless and Armless to Armless	SCSG-1	\$15.66
	Arm to Arm	SCSG-2	\$16.42

SCSG-1



Features

- Field retrofittable.
- Recommended for use on chairs with glides only.
- Release for fire safety.

To Order, Specify:

- 1) Product number.
(No finish specification required.)

SCSG-2
Class VY – SIN 711-19;
Discount Group XVIII

	Description	Number	Price
Stacking Carts			
 SCT-1	Stacking Cart	SCT-1	\$474.76
	<p>Features</p> <ul style="list-style-type: none"> Stacking Heights: <ul style="list-style-type: none"> With or Without Arms: -40 chairs on cart (75 1/2" high x 39 1/2" deep x 24" wide) -10 chairs on the floor (39 1/4" high x 23" wide x 33" deep) Upholstered Seat: -25 maximum stack quality on cart -25 armless on cart (61" high x 40 1/2" deep x 24" wide) -25 with arms on cart (69" high x 38" deep x 24" wide) Standard in black finish color only. Not for use with Wire Stacker stools. 	<p>To Order, Specify:</p> <p>1) Product number. (No color specification required.)</p>	
Stacking Carts			
 SCT-3 SCT-4	Side/Seminar Chairs with Arms	SCT-3	\$397.64
	Side/Seminar Chairs without Arms	SCT-4	397.64
	<p>Features</p> <ul style="list-style-type: none"> Permits stacking 8-high with glides and casters. Standard in black finish color only. Cart Only Dimensions: -SCT-3 25.5"(648mm) x 27"(685mm) x 13.8"(352mm) (wt: 10.09kg) -SCT-4 25.5"(648mm) x 30"(772mm) x 14.1"(359mm) (wt: 10.09kg) Not for use with Side Stools. 	<p>To Order, Specify:</p> <p>1) Product number. (No color specification required.)</p>	

This page intentionally blank

Very Task

General Specifications

At-A-Glance

The Very Task chair offers state-of-the-art ergonomic support, at a sensible price point. Very Task offers Haworth's patented asymmetrical lumbar along with supporting mesh. A clean simple aesthetic, with unlimited choices, allowing you to personalize how you want to sit and work.

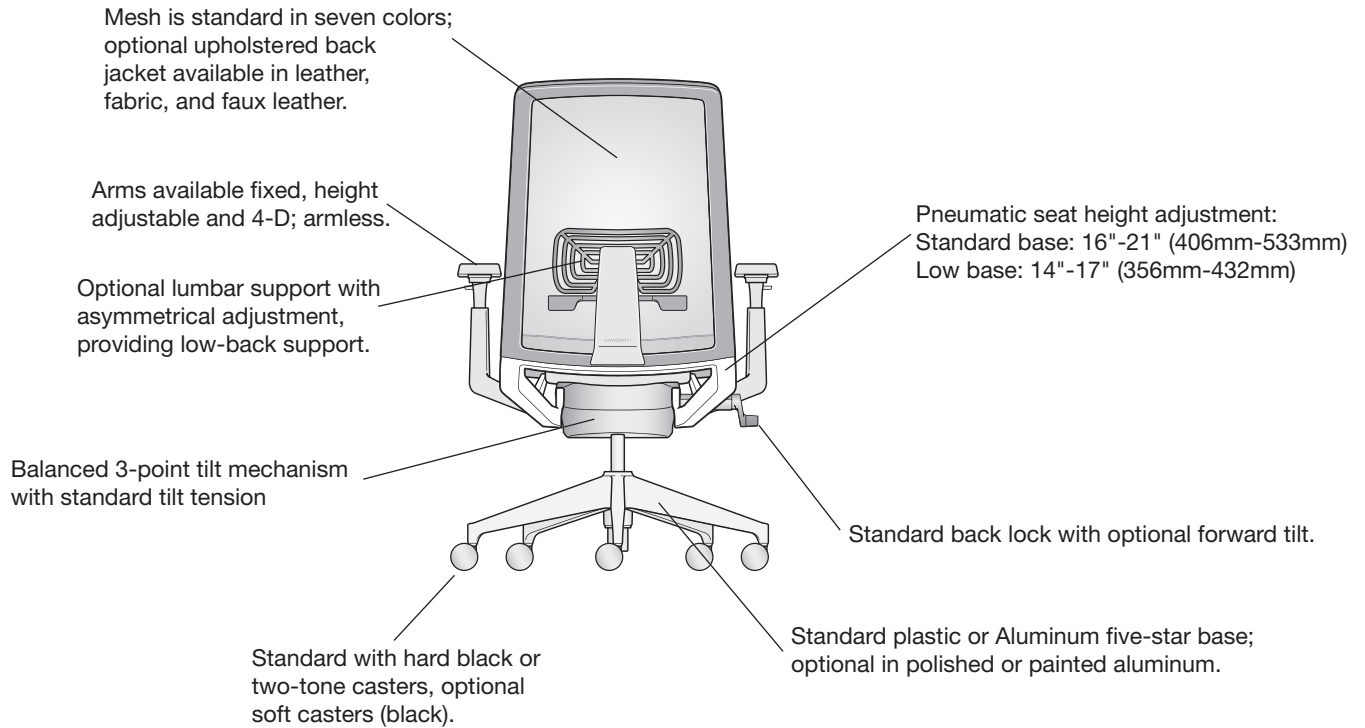

Very Task

General Specifications

Features and Options (Task Chair)

- Back: Mesh with optional upholstered back jacket.
- Seat: Standard upholstered with foam.
- Seat Type: Standard depth adjustable range 16"-19" (406mm-483mm).
- Base: Standard plastic or optional painted five-star aluminum base or optional polished aluminum.
- Optional low base 14"-17"(356mm-432mm) (not available in high polished)
- Arms: 4D, Height Adjustable arms, fixed arms with soft arm caps. Armless model available.
- Mechanism: Balanced 3-point tilt; standard tilt tension.
- Height adjustment: Pneumatic or low-position pneumatic.
- Standard Back lock.
- Optional Forward Tilt: 5 degrees downward from initial position.
- Optional Adjustable Lumbar: 4" adjustment, flexible support.
- Optional Headrest: Height adjustable with articulating movement.
- Casters: Five-star base with casters: hard (black or two-tone (fog and gray), soft (black).
- Headrest sent not attached.

General Guidelines for Product Specification

	<u>S</u>	<u>C</u>	<u>T - 2</u>	<u>0 - 4</u>	<u>1</u>	<u>1</u>	<u>1</u>	<u>3A-18</u>	<u>MS-FM</u>	<u>TR-F</u>	<u>TR-LE</u>	<u>TR-LE</u>
Product Fixed Arm	_____	_____	_____	_____	_____	_____	_____	_____	_____	_____	_____	_____
(S) Seating	_____	_____	_____	_____	_____	_____	_____	_____	_____	_____	_____	_____
Product Line	_____	_____	_____	_____	_____	_____	_____	_____	_____	_____	_____	_____
(C) Very	_____	_____	_____	_____	_____	_____	_____	_____	_____	_____	_____	_____
Model	_____	_____	_____	_____	_____	_____	_____	_____	_____	_____	_____	_____
(E) Headrest	_____	_____	_____	_____	_____	_____	_____	_____	_____	_____	_____	_____
(T) Task	_____	_____	_____	_____	_____	_____	_____	_____	_____	_____	_____	_____
Seat Upholstery	_____	_____	_____	_____	_____	_____	_____	_____	_____	_____	_____	_____
(1) Leather	_____	_____	_____	_____	_____	_____	_____	_____	_____	_____	_____	_____
(2) Fabric	_____	_____	_____	_____	_____	_____	_____	_____	_____	_____	_____	_____
(3) Faux Leather	_____	_____	_____	_____	_____	_____	_____	_____	_____	_____	_____	_____
Mesh Back	_____	_____	_____	_____	_____	_____	_____	_____	_____	_____	_____	_____
(0) Mesh - No Jacket	_____	_____	_____	_____	_____	_____	_____	_____	_____	_____	_____	_____
(1) Leather Back Jacket	_____	_____	_____	_____	_____	_____	_____	_____	_____	_____	_____	_____
(2) Fabric Back Jacket	_____	_____	_____	_____	_____	_____	_____	_____	_____	_____	_____	_____
(3) Faux Leather Back Jacket	_____	_____	_____	_____	_____	_____	_____	_____	_____	_____	_____	_____
Arms	_____	_____	_____	_____	_____	_____	_____	_____	_____	_____	_____	_____
(0) No Arms	_____	_____	_____	_____	_____	_____	_____	_____	_____	_____	_____	_____
(1) Fixed Arms	_____	_____	_____	_____	_____	_____	_____	_____	_____	_____	_____	_____
(4) Height Adjustable	_____	_____	_____	_____	_____	_____	_____	_____	_____	_____	_____	_____
(7) 4D Arms	_____	_____	_____	_____	_____	_____	_____	_____	_____	_____	_____	_____
Lumbar	_____	_____	_____	_____	_____	_____	_____	_____	_____	_____	_____	_____
(0) No Lumbar	_____	_____	_____	_____	_____	_____	_____	_____	_____	_____	_____	_____
(1) Lumbar	_____	_____	_____	_____	_____	_____	_____	_____	_____	_____	_____	_____
Back Lock	_____	_____	_____	_____	_____	_____	_____	_____	_____	_____	_____	_____
(1) Back Lock	_____	_____	_____	_____	_____	_____	_____	_____	_____	_____	_____	_____
(4) Forward Tilt/Back Lock	_____	_____	_____	_____	_____	_____	_____	_____	_____	_____	_____	_____
Base/Caster	_____	_____	_____	_____	_____	_____	_____	_____	_____	_____	_____	_____
(1) Aluminum Standard Base, Hard Caster	_____	_____	_____	_____	_____	_____	_____	_____	_____	_____	_____	_____
(2) Aluminum Standard Base, Soft Caster	_____	_____	_____	_____	_____	_____	_____	_____	_____	_____	_____	_____
(3) Aluminum Low Base, Hard Caster	_____	_____	_____	_____	_____	_____	_____	_____	_____	_____	_____	_____
(4) Aluminum Low Base, Soft Caster	_____	_____	_____	_____	_____	_____	_____	_____	_____	_____	_____	_____
(5) Plastic Standard Base, Hard Caster	_____	_____	_____	_____	_____	_____	_____	_____	_____	_____	_____	_____
(6) Plastic Standard Base, Soft Caster	_____	_____	_____	_____	_____	_____	_____	_____	_____	_____	_____	_____
(P) Plastic Standard Base, Two-Tone Caster	_____	_____	_____	_____	_____	_____	_____	_____	_____	_____	_____	_____
(T) Aluminum Standard Base, Two-Tone Caster	_____	_____	_____	_____	_____	_____	_____	_____	_____	_____	_____	_____
Seat Upholstery	_____	_____	_____	_____	_____	_____	_____	_____	_____	_____	_____	_____
Tellure	_____	_____	_____	_____	_____	_____	_____	_____	_____	_____	_____	_____
Back Upholstery	_____	_____	_____	_____	_____	_____	_____	_____	_____	_____	_____	_____
Mesh Snow	_____	_____	_____	_____	_____	_____	_____	_____	_____	_____	_____	_____
Trim Color (Plastic Components)	_____	_____	_____	_____	_____	_____	_____	_____	_____	_____	_____	_____
Black	_____	_____	_____	_____	_____	_____	_____	_____	_____	_____	_____	_____
Frame Trim Color (Aluminum)	_____	_____	_____	_____	_____	_____	_____	_____	_____	_____	_____	_____
Metallic Silver	_____	_____	_____	_____	_____	_____	_____	_____	_____	_____	_____	_____
Base Trim Color (Plastic or Aluminum)	_____	_____	_____	_____	_____	_____	_____	_____	_____	_____	_____	_____
Metallic Silver	_____	_____	_____	_____	_____	_____	_____	_____	_____	_____	_____	_____

Very Task

General Specifications

Environmental Factors	<ul style="list-style-type: none"> • Very Task is BIFMA level 3 certified. • Greenguard Gold certified for low emissions. • Very has up to 65% recycled content and is up to 98% recyclable. • Very is produced in an ISO 14001 certified manufacturing facility. • Very Task is part of the Haworth Take Back Program. • Haworth will take back Very chairs after their useful life and recycle the components. Please contact Haworth's Material Recovery Center at (616)393-1215.
COM & COL General Information	<p>To order a COM fabric (Customer's Own Material), contact the Haworth Inquiry Center (1.800.426.8562), your local Haworth dealer, or go to haworth.com/surfaces > COM Library to find out if the COM you have selected has already been tested and approved. The surface collection site also has information on the Haworth+ alliance program with Carnegie, Luna Textiles, and Maharam as well as our industry-leading Pre-Approved COM program.</p> <p>COM fabrics are placed into Grades based on the cost per linear yard. If a fabric's cost exceeds the range of our highest Grade it will be noted as Non-Graded. The product will be priced at Grade A; the COM fabric costs will appear as a separate line item. The fabric charge will be Haworth's purchase cost plus a 4% administrative fee (based on the cost of the fabric). Yardage calculations will include any applicable fabric repeat.</p> <p>COM Leather products will be priced at a leather Grade A; COL costs will appear as a separate line item. The leather costs will be Haworth's purchase cost plus a 4% administrative fee (based on the cost of the leather).</p>
Finishes and Fabrics	A complete listing of finishes and fabrics for Very seating is available in the back of the price list.
Shipping Weights (Including packaging)	<ul style="list-style-type: none"> • Chairs with arms: 55.2 pounds/1 chair per carton/17.37 cubic feet • Chairs without arms: 51.2 pounds/1 chair per carton/17.37 cubic feet
Seat	Stitched double seams. Vertically in the center and on the edges of the leather seat cushion.
Back	Vertical stitched double seams on the upholstered back jacket with leather and faux leather or Customers Own Leather or COM faux leather.

Very Task

General Specifications

STANDARD MOBILITY AND ADJUSTABILITY

Balanced 3-point tilt

**Features:**

- Balanced 3-point tilt mechanism.
- Back reclines 20° from the upright position.
- Seat pan moves downward 3° from the initial position.
- 2:1 recline ratio.

Benefits:

- Comfortable relaxed posture.
- Recline allows for the opening of the users' chest cavity providing good airflow to promote alertness.
- Users' feet remain flat on the floor.

Tilt Tension Control

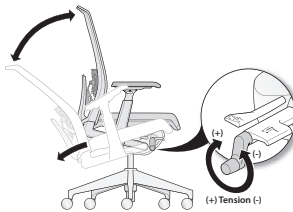
**Feature:**

- Easy-to-reach and easy-to-activate side-mounted unlimited tilt tension control regulates the amount of resistance felt when leaning back in the chair and the effort required to recline the chair backwards.

Benefit:

- Personalized support to accommodate users of different body types and different work styles.

Seat Height Adjustment

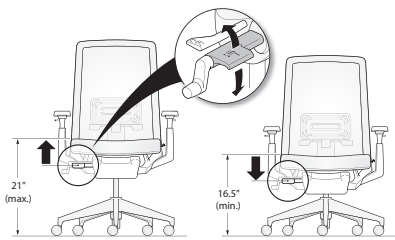
**Features:**

- Pneumatic seat height adjustment.
- Seat height adjusts 5"(127mm) from 16" to 21"(406mm to 533mm) in standard models. Low-position adjusts 14" to 17"(356 to 432mm).

Benefits:

- Ensures the comfort of the lower limbs by avoiding pressure on the underside of the thigh caused by a seat pan that is too high, or decreased thigh-to-torso angle if the seat pan is too low.
- Seat height adjustment also is important in setting the proper hand position and allowing for a proper sitting eye height.

Seat Depth Adjustment

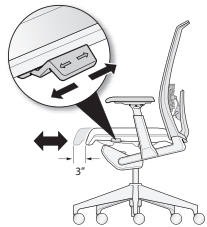
**Features:**

- 3"(76mm) of seat depth range.

Benefit:

- Supports the thighs, allows users to rest against the seat back for back support, and avoids pressure on the back of the knees of small to tall users.

Back Lock

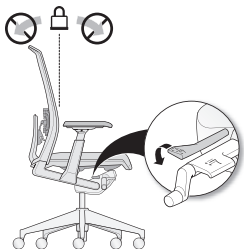
**Feature:**

- Single position Back Lock.

Benefit:

- Allows users to lock the back of the chair in the upright position for tasking application.

Very Task

General Specifications

OPTIONAL MOBILITY AND ADJUSTABILITY

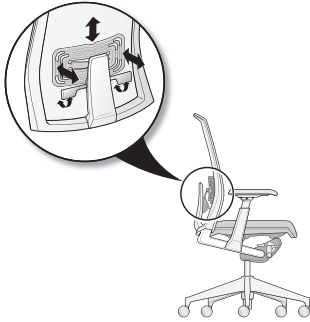
Lumbar Support**Features:**

- Asymmetrical Left/right Lumbar Adjustment adjusts 4"(102mm) in height, flexible lumbar support with depth adjustment.

Benefits:

- Lumbar adjustment maintains the natural curvature of the spine at the lower back and allows users to choose the support that feels right for them.

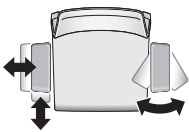
4D Arm**Features:**

- Optional 4D arm.
- Arm adjusts in 4 ways:
 - Height adjustment: 4"(102mm)
 - Side-to-side arm cap adjustment range: 3"(76mm) [1.5"(38.1mm) each arm cap]
 - Front-to-back adjustment range: 3 1/2"(89mm)
 - Pivoting: In 20°; out 20°

Benefits:

- Arms support the muscular system of users' neck and shoulders and proper arm support provides back relief. Arms can be an aid in standing or sitting down.
- Height adjustment accommodates for users with varying elbow rest heights so that users avoid lifting their shoulders or leaning sideways to get arm support.
- Front-to-back adjustment adjusts the armrest length, which is important because it allows users to get close to the worksurface while maintaining the effective use of the backrest.
- Side-to-side adjustment ensures a comfortable resting position for the arms with proper support of the forearm while allowing for easy entry/exit of the chair.
- Pivoting provides proper support of the forearm when performing tasks involving keying and mousing.

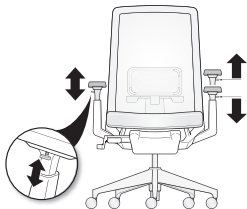
Adjustable Height Arm**Feature:**

- Optional height adjustable arms adjust 4"(102mm) vertically.

Benefit:

- Height adjustment accommodates users with varying elbow rest heights so that users avoid lifting their shoulders or leaning sideways to get arm support.

Forward Tilt**Features:**

- Optional forward tilt.
- 5°

Benefit:

- Allows users the ability to elect an upright forward position.

Headrest**Features:**

- Height adjustable 4.2"(107mm), articulating movement of headrest pad and mount to fit a wide range of users.
- Headrest is TPU material. Available in two finishes; Black or fog, coordinates with the chair's arm rest color specified.
- See price pages for specification (available on all models).
- To add a headrest to an existing model in the field order service part: Back and Headrest placement, see e-Parts.
- Headrest sent not attached.

Very Task Value Model

Task Chair with 4D Arms



SCT-20-7115

Dimensions

*SH: 16-21"
(406mm-533mm)
H: 39-44"
(991mm-1118mm)
D: 26"(660mm)
W: 27"(686mm)
*SW: 19"(483mm)

* Measurements taken with the BIFMA chair measuring device.

Features

- Back: Soft mesh.
- Seat: Standard upholstered foam (3 lbs. polyurethane foam construction).
- Seat Depth Adjustment: Standard adjustable range 16"-19" (406mm-483mm).
- Base: Plastic base.
- Arms: 4D with soft arm caps. Arm adjusts up and down, side to side.
- Mechanism: Balanced 3-point tilt; standard tilt tension.
- Back Lock: Single position upright back lock.
- Asymmetrical Lumbar Adjustment: 4"(102mm) height adjustment; support level can be adjusted independently for right or left hand side of users body.
- Casters: Hard black

To Order, Specify:

- 1) Product number.
- 2) Seat surface/color: 3A-18 Tellure - Black
- 3) Mesh Back: MS-F Black
- 4) Plastic trim color (including base): TR-F Black
- 5) Aluminum trim color: TR-F Black

Note: No changes to specification. No COM or Tailored Solutions.

Number	Price
SCT-20-7115	\$805.80

This page intentionally blank

Very Task

Task Chair with 4D Arms



SCT-20-7011

Dimensions

- *SH: 16-21"(406mm-533mm)
- H: 39-44"(991mm-1118mm)
- D: 26"(660mm)
- W: 27"(686mm)
- *SW: 19"(483mm)

Low Base:
14-17"(356mm-432mm)

* Measurements taken with the BIFMA chair measuring device.

Features

- Back: Soft mesh or mesh back with upholstered back jacket.
- Seat: Standard upholstered foam (3 lbs. polyurethane foam construction).
- Seat Depth Adjustment: Standard adjustable range 16"-19" (406mm-483mm).
- Base: Plastic base or optional painted five-star aluminum or polished aluminum base.
- Arms: 4D with soft arm caps. Arm adjusts up and down, side to side.
- Mechanism: Balanced 3-point tilt; standard tilt tension.
- Back Lock: Single position upright back lock.
- Optional Forward Tilt: 5 degrees downward from initial position.
- Optional Asymmetrical Lumbar Adjustment: 4"(102mm) height adjustment; support level can be adjusted independently for right or left hand side of users body.
- Casters: Standard with hard black or two-tone casters; optional soft casters.
- COM yardage / COL square footage:
 - Mesh back model: 0.83/20
 - Mesh back/upholstered back jacket: 1.5/40

NOTE: When specifying a back jacket; must also specify mesh surface color for outside of back. Back jacket is not field retrofittable. To add a back jacket in the field, see e-Parts for replacement back with an attached jacket.

To Order, Specify:

1) Product number, including:

1 Base/Caster Option:**Aluminum Base**

- 1** Aluminum Std. Base, Hard Caster
- 2** Aluminum Std. Base, Soft Caster
- T** Aluminum Std. Base, Two-Tone Casters
- 3** Aluminum Low Base, Hard Caster
- 4** Aluminum Low Base, Soft Caster

Plastic Base

- 5** Plastic Std. Base, Hard Caster
- 6** Plastic Std. Base, Soft Caster
- P** Plastic Std. Base, Two-Tone Casters

- 2) Fabric surface and color (seat).
- 3) Mesh surface and color (back).
- 4) Back Jacket (if applicable) Fabric surface and color.
- 5) Trim color (plastic components) (arm caps, control cover, adjustment levers, 4D or height adjustable arm uprights).

Note: If TR-UFM is specified, arm caps and adjustment levers default to TR-7 Fog. (Add **\$94.04** list for TR-UFM Snow.)

- 6) Frame trim color (aluminum components - underside of chair).
- 7) Base trim color (plastic or aluminum) dependent upon base style selected; TR-UFM Snow (plastic) and TR-FS Snowfall (aluminum) not available.

Note: If PM-P Polished Aluminum is selected for aluminum frame components (#6) or aluminum base (#7), or both, a total upcharge of **\$192.63** list will apply.

Very Task

Task Chair with 4D Arms

Upholstered Seat Adjustments	Number ①	Fabric Grade								Leather Grade A	Leather Grade B
		A	B	C	D	E	F	G	H		
Plastic Base - Mesh Back											
Back Lock	SCT-20-701	\$ 946.98	\$ 981.77	\$ 1019.06	\$ 1036.46	\$ 1051.37	\$ 1083.69	\$ 1113.51	\$ 1193.05	\$ 1263.88	\$ 1418.99
Forward Tilt/Back Lock	SCT-20-704	1015.34	1050.13	1087.42	1104.82	1119.73	1152.05	1181.87	1261.41	1332.24	1487.35
Plastic Base - Upholstered Back Jacket											
Back Lock	SCT-22-701	\$ 1077.47	\$ 1147.05	\$ 1221.63	\$ 1256.43	\$ 1286.25	\$ 1350.89	\$ 1410.53	\$ 1569.61	\$ 1711.27	\$ 2021.49
Forward Tilt/Back Lock	SCT-22-704	1145.83	1215.41	1289.99	1324.79	1354.61	1419.25	1478.89	1637.97	1779.63	2089.85
Plastic Base with Lumbar Adjustment - Mesh Back											
Back Lock	SCT-20-711	\$ 1033.98	\$ 1068.77	\$ 1106.06	\$ 1123.46	\$ 1138.37	\$ 1170.69	\$ 1200.51	\$ 1280.05	\$ 1350.88	\$ 1505.99
Forward Tilt/Back Lock	SCT-20-714	1102.34	1137.13	1174.42	1191.82	1206.73	1239.05	1268.87	1348.41	1419.24	1574.35
Plastic Base with Lumbar Adjustment - Upholstered Back Jacket											
Back Lock	SCT-22-711	\$ 1164.47	\$ 1234.05	\$ 1308.63	\$ 1343.43	\$ 1373.25	\$ 1437.89	\$ 1497.53	\$ 1656.61	\$ 1798.27	\$ 2108.49
Forward Tilt/Back Lock	SCT-22-714	1232.83	1302.41	1376.99	1411.79	1441.61	1506.25	1565.89	1724.97	1866.63	2176.85
Aluminum Base - Mesh Back											
Back Lock	SCT-20-701	\$ 1009.12	\$ 1043.91	\$ 1081.20	\$ 1098.60	\$ 1113.51	\$ 1145.83	\$ 1175.65	\$ 1255.19	\$ 1326.02	\$ 1481.13
Forward Tilt/Back Lock	SCT-20-704	1077.48	1112.27	1149.56	1166.96	1181.87	1214.19	1244.01	1323.55	1394.38	1549.49
Aluminum Base - Upholstered Back Jacket											
Back Lock	SCT-22-701	\$ 1139.61	\$ 1209.19	\$ 1283.77	\$ 1318.57	\$ 1348.39	\$ 1413.03	\$ 1472.67	\$ 1631.75	\$ 1773.41	\$ 2083.63
Forward Tilt/Back Lock	SCT-22-704	1207.97	1277.55	1352.13	1386.93	1416.75	1481.39	1541.03	1700.11	1841.77	2151.99
Aluminum Base with Lumbar Adjustment - Mesh Back											
Back Lock	SCT-20-711	\$ 1096.12	\$ 1130.91	\$ 1168.20	\$ 1185.60	\$ 1200.51	\$ 1232.83	\$ 1262.65	\$ 1342.19	\$ 1413.02	\$ 1568.13
Forward Tilt/Back Lock	SCT-20-714	1164.48	1199.27	1236.56	1253.96	1268.87	1301.19	1331.01	1410.55	1481.38	1636.49
Aluminum Base with Lumbar Adjustment - Upholstered Back Jacket											
Back Lock	SCT-22-711	\$ 1226.61	\$ 1296.19	\$ 1370.77	\$ 1405.57	\$ 1435.39	\$ 1500.03	\$ 1559.67	\$ 1718.75	\$ 1860.41	\$ 2170.63
Forward Tilt/Back Lock	SCT-22-714	1294.97	1364.55	1439.13	1473.93	1503.75	1568.39	1628.03	1787.11	1928.77	2238.99

The following options require modification of the product number.

CAL 133
Headrest

To specify, add **F** to the end of the product number; **Example:** SCT-20-7011F (add **\$146.66** list)
To specify, change the 3rd digit from a T to an E. **Example:** SCE-22-7112 with headrest (add **\$87.00** list)

Leather Seat with Mesh Back
Leather Seat with Leather Upholstered Back Jacket
Faux Leather Seat with Mesh Back
Stain repellent

NOTE: CAL 133 is available on SCT-20 models only.

To specify, change the 4th digit to **1**; **Example:** SCT-10-7011
To specify, change the 4th digit to **1** and 5th digit to **1**; **Example:** SCT-11-7011
To specify, change the 4th digit to **3**; **Example:** SCT-30-7011
To specify, add **P** to end of the product number; **Example:** SCT-20-7011P (add **\$38.53** list)

NOTE: Stain repellent is available on SCT-20 and SCT-22 models only.

Very Task

Task Chair with Height Adjustable Arms

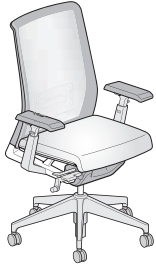

SCT-20-4011

Dimensions

*SH: 16-21"(406mm-533mm)
 H: 39-44"(991mm-1118mm)
 D: 26"(660mm)
 W: 27"(686mm)
 *SW: 19"(483mm)

Low Base:
 14-17"(356mm-432mm)

* Measurements taken with the BIFMA chair measuring device.

Features

- Back: Soft mesh only or mesh back with upholstered back jacket.
- Seat: Standard upholstered foam (3 lbs. polyurethane foam construction).
- Seat Depth Adjustment: Standard adjustable range 16"-19" (406mm-483mm).
- Base: Plastic base or optional painted five-star aluminum or polished aluminum base.
- Arms: Height-adjustable arms with plastic uprights (black or fog) with soft arm caps.
- Mechanism: Balanced 3-point tilt; standard tilt tension.
- Back Lock: Single position upright back lock.
- Optional Forward Tilt: 5 degrees downward from initial position.
- Optional Asymmetrical Lumbar Adjustment: 4"(102mm) height adjustment; support level can be adjusted independently for right or left hand side of users body.
- Casters: Standard with hard black or two-tone casters; optional soft casters.
- COM yardage / COL square footage:
 Mesh back model: 0.83/20
 Mesh back/upholstered back jacket: 1.5/40

NOTE: When specifying a back jacket; must also specify mesh surface color for outside of back. Back jacket is not field retrofittable. To add a back jacket in the field, see e-Parts for replacement back with an attached jacket.

To Order, Specify:

1) Product number, including:

1 Base/Caster Option:**Aluminum Base**

- 1** Aluminum Std. Base, Hard Caster
- 2** Aluminum Std. Base, Soft Caster
- T** Aluminum Std. Base, Two-Tone Casters
- 3** Aluminum Low Base, Hard Caster
- 4** Aluminum Low Base, Soft Caster

Plastic Base

- 5** Plastic Std. Base, Hard Caster
- 6** Plastic Std. Base, Soft Caster
- P** Plastic Std. Base, Two-Tone Casters

- 2) Fabric surface and color (seat).
- 3) Mesh surface and color (back).
- 4) Back Jacket (if applicable) Fabric surface and color.
- 5) Trim color (plastic components) (arm caps, control cover, adjustment levers, 4D or height adjustable arm uprights).

Note: If TR-UFM is specified, arm caps and adjustment levers default to TR-7 Fog. (Add **\$94.04** list for TR-UFM Snow.)

- 6) Frame trim color (aluminum components - underside of chair).
- 7) Base trim color (plastic or aluminum) dependent upon base style selected; TR-UFM Snow (plastic) and TR-FS Snowfall (aluminum) not available.

Note: If PM-P Polished Aluminum is selected for aluminum frame components (#6) or aluminum base (#7), or both, a total upcharge of **\$192.63** list will apply.

Very Task

Task Chair with Height Adjustable Arms

Upholstered Foam Seat Adjustments	Number ①	Fabric Grade								Leather Grade A	Leather Grade B
		A	B	C	D	E	F	G	H		
Plastic Base - Mesh Back											
Back Lock	SCT-20-401	\$ 884.84	\$ 919.63	\$ 956.92	\$ 974.32	\$ 989.23	\$ 1021.55	\$ 1051.37	\$ 1130.91	\$ 1201.74	\$ 1356.85
Forward Tilt/Back Lock	SCT-20-404	953.20	987.99	1025.28	1042.68	1057.59	1089.91	1119.73	1199.27	1270.10	1425.21
Plastic Base - Upholstered Back Jacket											
Back Lock	SCT-22-401	\$ 1015.33	\$ 1084.91	\$ 1159.49	\$ 1194.29	\$ 1224.11	\$ 1288.75	\$ 1348.39	\$ 1507.47	\$ 1649.13	\$ 1959.35
Forward Tilt/Back Lock	SCT-22-404	1083.69	1153.27	1227.85	1262.65	1292.47	1357.11	1416.75	1575.83	1717.49	2027.71
Plastic Base with Lumbar Adjustment - Mesh Back											
Back Lock	SCT-20-411	\$ 971.84	\$ 1006.63	\$ 1043.92	\$ 1061.32	\$ 1076.23	\$ 1108.55	\$ 1138.37	\$ 1217.91	\$ 1288.74	\$ 1443.85
Forward Tilt/Back Lock	SCT-20-414	1040.20	1074.99	1112.28	1129.68	1144.59	1176.91	1206.73	1286.27	1357.10	1512.21
Plastic Base with Lumbar Adjustment - Upholstered Back Jacket											
Back Lock	SCT-22-411	\$ 1102.33	\$ 1171.91	\$ 1246.49	\$ 1281.29	\$ 1311.11	\$ 1375.75	\$ 1435.39	\$ 1594.47	\$ 1736.13	\$ 2046.35
Forward Tilt/Back Lock	SCT-22-414	1170.69	1240.27	1314.85	1349.65	1379.47	1444.11	1503.75	1662.83	1804.49	2114.71
Aluminum Base - Mesh Back											
Back Lock	SCT-20-401	\$ 946.98	\$ 981.77	\$ 1019.06	\$ 1036.46	\$ 1051.37	\$ 1083.69	\$ 1113.51	\$ 1193.05	\$ 1263.88	\$ 1418.99
Forward Tilt/Back Lock	SCT-20-404	1015.34	1050.13	1087.42	1104.82	1119.73	1152.05	1181.87	1261.41	1332.24	1487.35
Aluminum Base - Upholstered Back Jacket											
Back Lock	SCT-22-401	\$ 1077.47	\$ 1147.05	\$ 1221.63	\$ 1256.43	\$ 1286.25	\$ 1350.89	\$ 1410.53	\$ 1569.61	\$ 1711.27	\$ 2021.49
Forward Tilt/Back Lock	SCT-22-404	1145.83	1215.41	1289.99	1324.79	1354.61	1419.25	1478.89	1637.97	1779.63	2089.85
Aluminum Base with Lumbar Adjustment - Mesh Back											
Back Lock	SCT-20-411	\$ 1033.98	\$ 1068.77	\$ 1106.06	\$ 1123.46	\$ 1138.37	\$ 1170.69	\$ 1200.51	\$ 1280.05	\$ 1350.88	\$ 1505.99
Forward Tilt/Back Lock	SCT-20-414	1102.34	1137.13	1174.42	1191.82	1206.73	1239.05	1268.87	1348.41	1419.24	1574.35
Aluminum Base with Lumbar Adjustment - Upholstered Back Jacket											
Back Lock	SCT-22-411	\$ 1164.47	\$ 1234.05	\$ 1308.63	\$ 1343.43	\$ 1373.25	\$ 1437.89	\$ 1497.53	\$ 1656.61	\$ 1798.27	\$ 2108.49
Forward Tilt/Back Lock	SCT-22-414	1232.83	1302.41	1376.99	1411.79	1441.61	1506.25	1565.89	1724.97	1866.63	2176.85

The following options require modification of the product number.

CAL 133
Headrest

To specify, add **F** to the end of the product number; **Example:** SCT-20-4011**F** (add **\$146.66** list)
To specify, change the 3rd digit from a T to an E. Example: SCE-22-7112 with headrest (add **\$87.00** list)

Leather Seat with Mesh Back
Leather Seat with Leather Upholstered Back Jacket
Faux Leather Seat with Mesh Back
Stain repellent

NOTE: CAL 133 is available on SCT-20 models only.
To specify, change the 4th digit to **1**; **Example:** SCT-10-4011
To specify, change the 4th digit to **1** and 5th digit to **1**; **Example:** SCT-11-4011
To specify, change the 4th digit to **3**; **Example:** SCT-30-4011
To specify, add **P** to end of the product number; **Example:** SCT-20-4011**P** (add **\$38.53** list)

NOTE: Stain repellent is available on SCT-20 and SCT-22 models only.

Very Task

Task Chair with Fixed Arms



SCT-20-1011

Dimensions

*SH: 16-21"(406mm-533mm)
 H: 39-44"(991mm-1118mm)
 D: 26"(660mm)
 W: 27"(686mm)
 *SW: 19"(483mm)

Low Base:
 14-17"(356mm-432mm)

* Measurements taken with the BIFMA chair measuring device.

Features

- Back: Soft mesh only or mesh back with upholstered back jacket.
- Seat: Standard upholstered foam (3 lbs. polyurethane foam construction).
- Seat Depth Adjustment: Standard adjustable range 16"-19" (406mm-483mm).
- Seat Type: Standard adjustable 3"(76mm) range.
- Base: Plastic base or optional painted five-star aluminum or polished aluminum base.
- Arms: Fixed height arms with aluminum uprights in either painted or polished, soft arm caps.
- Mechanism: Balanced 3-point tilt; standard tilt tension.
- Back Lock: Single position upright back lock.
- Optional Forward Tilt: 5 degrees downward from initial position.
- Optional Asymmetrical Lumbar Adjustment: 4"(102mm) height adjustment; support level can be adjusted independently for right or left hand side of users body.
- Casters: Standard with hard black or two-tone casters; optional soft casters.
- COM yardage / COL square footage:
 Mesh back model: 0.83/20
 Mesh back/upholstered back jacket: 1.5/40

NOTE: When specifying a back jacket; must also specify mesh surface color for outside of back. Back jacket is not field retrofittable. To add a back jacket in the field, see e-Parts for replacement back with an attached jacket.

To Order, Specify:

1) Product number, including:

1 Base/Caster Option:**Aluminum Base**

- 1** Aluminum Std. Base, Hard Caster
- 2** Aluminum Std. Base, Soft Caster
- T** Aluminum Std. Base, Two-Tone Casters
- 3** Aluminum Low Base, Hard Caster
- 4** Aluminum Low Base, Soft Caster

Plastic Base

- 5** Plastic Std. Base, Hard Caster
- 6** Plastic Std. Base, Soft Caster
- P** Plastic Std. Base, Two-Tone Casters

- 2) Fabric surface and color (seat).
- 3) Mesh surface and color (back).
- 4) Back Jacket (if applicable) Fabric surface and color.
- 5) Trim color (plastic components) (arm caps, control cover, adjustment levers, 4D or height adjustable arm uprights).

Note: If TR-UFM is specified, arm caps and adjustment levers default to TR-7 Fog. (Add **\$94.04** list for TR-UFM Snow.)

- 6) Frame trim color (aluminum components - underside of chair).
- 7) Base trim color (plastic or aluminum) dependent upon base style selected; TR-UFM Snow (plastic) and TR-FS Snowfall (aluminum) not available.

Note: If PM-P Polished Aluminum is selected for aluminum frame components (#6) or aluminum base (#7), or both, a total upcharge of **\$192.63** list will apply.

Very Task

Task Chair with Fixed Arms

Upholstered Foam Seat Adjustments	Number ①	Fabric Grade								Leather Grade A	Leather Grade B
		A	B	C	D	E	F	G	H		
Plastic Base - Mesh Back											
Back Lock	SCT-20-101	\$ 872.41	\$ 907.20	\$ 944.49	\$ 961.89	\$ 976.80	\$ 1009.12	\$ 1038.94	\$ 1118.48	\$ 1189.31	\$ 1344.42
Forward Tilt/Back Lock	SCT-20-104	940.77	975.56	1012.85	1030.25	1045.16	1077.48	1107.30	1186.84	1257.67	1412.78
Plastic Base - Upholstered Back Jacket											
Back Lock	SCT-22-101	\$ 1002.90	\$ 1072.48	\$ 1147.06	\$ 1181.86	\$ 1211.68	\$ 1276.32	\$ 1335.96	\$ 1495.04	\$ 1636.70	\$ 1946.92
Forward Tilt/Back Lock	SCT-22-104	1071.26	1140.84	1215.42	1250.22	1280.04	1344.68	1404.32	1563.40	1705.06	2015.28
Plastic Base with Lumbar Adjustment - Mesh Back											
Back Lock	SCT-20-111	\$ 959.41	\$ 994.20	\$ 1031.49	\$ 1048.89	\$ 1063.80	\$ 1096.12	\$ 1125.94	\$ 1205.48	\$ 1276.31	\$ 1431.42
Forward Tilt/Back Lock	SCT-20-114	1027.77	1062.56	1099.85	1117.25	1132.16	1164.48	1194.30	1273.84	1344.67	1499.78
Plastic Base with Lumbar Adjustment - Upholstered Back Jacket											
Back Lock	SCT-22-111	\$ 1089.90	\$ 1159.48	\$ 1234.06	\$ 1268.86	\$ 1298.68	\$ 1363.32	\$ 1422.96	\$ 1582.04	\$ 1723.70	\$ 2033.92
Forward Tilt/Back Lock	SCT-22-114	1158.26	1227.84	1302.42	1337.22	1367.04	1431.68	1491.32	1650.40	1792.06	2102.28
Aluminum Base - Mesh Back											
Back Lock	SCT-20-101	\$ 934.55	\$ 969.34	\$ 1006.63	\$ 1024.03	\$ 1038.94	\$ 1071.26	\$ 1101.08	\$ 1180.62	\$ 1251.45	\$ 1406.56
Forward Tilt/Back Lock	SCT-20-104	1002.91	1037.70	1074.99	1092.39	1107.30	1139.62	1169.44	1248.98	1319.81	1474.92
Aluminum Base - Upholstered Back Jacket											
Back Lock	SCT-22-101	\$ 1065.04	\$ 1134.62	\$ 1209.20	\$ 1244.00	\$ 1273.82	\$ 1338.46	\$ 1398.10	\$ 1557.18	\$ 1698.84	\$ 2009.06
Forward Tilt/Back Lock	SCT-22-104	1133.40	1202.98	1277.56	1312.36	1342.18	1406.82	1466.46	1625.54	1767.20	2077.42
Aluminum Base with Lumbar Adjustment - Mesh Back											
Back Lock	SCT-20-111	\$ 1021.55	\$ 1056.34	\$ 1093.63	\$ 1111.03	\$ 1125.94	\$ 1158.26	\$ 1188.08	\$ 1267.62	\$ 1338.45	\$ 1493.56
Forward Tilt/Back Lock	SCT-20-114	1089.91	1124.70	1161.99	1179.39	1194.30	1226.62	1256.44	1335.98	1406.81	1561.92
Aluminum Base with Lumbar Adjustment - Upholstered Back Jacket											
Back Lock	SCT-22-111	\$ 1152.04	\$ 1221.62	\$ 1296.20	\$ 1331.00	\$ 1360.82	\$ 1425.46	\$ 1485.10	\$ 1644.18	\$ 1785.84	\$ 2096.06
Forward Tilt/Back Lock	SCT-22-114	1220.40	1289.98	1364.56	1399.36	1429.18	1493.82	1553.46	1712.54	1854.20	2164.42

The following options require modification of the product number.

CAL 133
Headrest

To specify, add **F** to the end of the product number; **Example:** SCT-20-1011**F** (add **\$146.66** list)
To specify, change the 3rd digit from a T to an E. Example: SCE-22-7112 with headrest (add **\$87.00** list)

Leather Seat with Mesh Back
Leather Seat with Leather Upholstered Back Jacket
Faux Leather Seat with Mesh Back
Stain repellent

NOTE: CAL 133 is available on SCT-20 models only.
To specify, change the 4th digit to **1**; **Example:** SCT-10-1011
To specify, change the 4th digit to **1** and 5th digit to **1**; **Example:** SCT-11-1011
To specify, change the 4th digit to **3**; **Example:** SCT-30-1011
To specify, add **P** to end of the product number; **Example:** SCT-20-1011**P** (add **\$38.53** list)

NOTE: Stain repellent is available on SCT-20 and SCT-22 models only.

Very Task

Task Chair without Arms



SCT-20-0011

Dimensions

- *SH: 16-21"(406mm-533mm)
- H: 39-44"(991mm-1118mm)
- D: 26"(660mm)
- W: 27"(686mm)
- *SW: 19"(483mm)

Low Base:
14-17"(356mm-432mm)

* Measurements
taken with the
BIFMA chair
measuring device.

Features

- Back: Soft mesh only or mesh back with upholstered back jacket.
- Seat: Standard upholstered foam (3 lbs. polyurethane foam construction).
- Seat Depth Adjustment: Standard Adjustable range 16"-19" (406mm-483mm).
- Seat Type: Standard adjustable 3"(76mm) range.
- Base: Plastic base or optional painted five-star aluminum or polished aluminum base.
- Mechanism: Balanced 3-point tilt; standard tilt tension.
- Back Lock: Single position upright back lock.
- Optional Forward Tilt: 5 degrees downward from initial position.
- Optional Asymmetrical Lumbar Adjustment: 4"(102mm) height adjustment; support level can be adjusted independently for right or left hand side of users body.
- Casters: Standard with hard black or two-tone casters; optional soft casters.
- COM yardage / COL square footage:
Mesh back model: 0.83/20
Mesh back/upholstered back jacket: 1.5/40

NOTE: When specifying a back jacket; must also specify mesh surface color for outside of back. Back jacket is not field retrofittable. To add a back jacket in the field, see e-Parts for replacement back with an attached jacket.

To Order, Specify:

1) Product number, including:

1 Base/Caster Option:

Aluminum Base

- 1** Aluminum Std. Base, Hard Caster
- 2** Aluminum Std. Base, Soft Caster
- T** Aluminum Std. Base, Two-Tone Casters
- 3** Aluminum Low Base, Hard Caster
- 4** Aluminum Low Base, Soft Caster

Plastic Base

- 5** Plastic Std. Base, Hard Caster
- 6** Plastic Std. Base, Soft Caster
- P** Plastic Std. Base, Two-Tone Casters

2) Fabric surface and color (seat).

3) Mesh surface and color (back).

4) Back Jacket (if applicable) Fabric surface and color.

5) Trim color (plastic components) (arm caps, control cover, adjustment levers, 4D or height adjustable arm uprights).

Note: If TR-UFM is specified, arm caps and adjustment levers default to TR-7 Fog. (Add **\$94.04** list for TR-UFM Snow.)

6) Frame trim color (aluminum components - underside of chair).

7) Base trim color (plastic or aluminum) dependent upon base style selected; TR-UFM Snow (plastic) and TR-FS Snowfall (aluminum) not available.

Note: If PM-P Polished Aluminum is selected for aluminum frame components (#6) or aluminum base (#7), or both, a total upcharge of **\$192.63** list will apply.

Very Task

Task Chair without Arms

Upholstered Foam Seat Adjustments	Number ①	Fabric Grade								Leather Grade A	Leather Grade B
		A	B	C	D	E	F	G	H		
Plastic Base - Mesh Back											
Back Lock	SCT-20-001	\$ 729.50	\$ 764.29	\$ 801.58	\$ 818.98	\$ 833.89	\$ 866.21	\$ 896.03	\$ 975.57	\$1046.40	\$1201.51
Forward Tilt/Back Lock	SCT-20-004	797.86	832.65	869.94	887.34	902.25	934.57	964.39	1043.93	1114.76	1269.87
Plastic Base - Upholstered Back Jacket											
Back Lock	SCT-22-001	\$ 859.99	\$ 929.57	\$1004.15	\$1038.95	\$1068.77	\$1133.41	\$1193.05	\$1352.13	\$1493.79	\$1804.01
Forward Tilt/Back Lock	SCT-22-004	928.35	997.93	1072.51	1107.31	1137.13	1201.77	1261.41	1420.49	1562.15	1872.37
Plastic Base with Lumbar Adjustment - Mesh Back											
Back Lock	SCT-20-011	\$ 816.50	\$ 851.29	\$ 888.58	\$ 905.98	\$ 920.89	\$ 953.21	\$ 983.03	\$1062.57	\$1133.40	\$1288.51
Forward Tilt/Back Lock	SCT-20-014	884.86	919.65	956.94	974.34	989.25	1021.57	1051.39	1130.93	1201.76	1356.87
Plastic Base with Lumbar Adjustment - Upholstered Back Jacket											
Back Lock	SCT-22-011	\$ 946.99	\$1016.57	\$1091.15	\$1125.95	\$1155.77	\$1220.41	\$1280.05	\$1439.13	\$1580.79	\$1891.01
Forward Tilt/Back Lock	SCT-22-014	1015.35	1084.93	1159.51	1194.31	1224.13	1288.77	1348.41	1507.49	1649.15	1959.37
Aluminum Base - Mesh Back											
Back Lock	SCT-20-001	\$ 791.64	\$ 826.43	\$ 863.72	\$ 881.12	\$ 896.03	\$ 928.35	\$ 958.17	\$1037.71	\$1108.54	\$1263.65
Forward Tilt/Back Lock	SCT-20-004	860.00	894.79	932.08	949.48	964.39	996.71	1026.53	1106.07	1176.90	1332.01
Aluminum Base - Upholstered Back Jacket											
Back Lock	SCT-22-001	\$ 922.13	\$ 991.71	\$1066.29	\$1101.09	\$1130.91	\$1195.55	\$1255.19	\$1414.27	\$1555.93	\$1866.15
Forward Tilt/Back Lock	SCT-22-004	990.49	1060.07	1134.65	1169.45	1199.27	1263.91	1323.55	1482.63	1624.29	1934.51
Aluminum Base with Lumbar Adjustment - Mesh Back											
Back Lock	SCT-20-011	\$ 878.64	\$ 913.43	\$ 950.72	\$ 968.12	\$ 983.03	\$1015.35	\$1045.17	\$1124.71	\$1195.54	\$1350.65
Forward Tilt/Back Lock	SCT-20-014	947.00	981.79	1019.08	1036.48	1051.39	1083.71	1113.53	1193.07	1263.90	1419.01
Aluminum Base with Lumbar Adjustment - Upholstered Back Jacket											
Back Lock	SCT-22-011	\$1009.13	\$1078.71	\$1153.29	\$1188.09	\$1217.91	\$1282.55	\$1342.19	\$1501.27	\$1642.93	\$1953.15
Forward Tilt/Back Lock	SCT-22-014	1077.49	1147.07	1221.65	1256.45	1286.27	1350.91	1410.55	1569.63	1711.29	2021.51

The following options require modification of the product number.

CAL 133
Headrest

To specify, add **F** to the end of the product number; **Example:** SCT-20-0111F (add **\$146.66** list)
To specify, change the 3rd digit from a T to an E. Example: SCE-22-7112 with headrest (add **\$87.00** list)

Leather Seat with Mesh Back
Leather Seat with Leather Upholstered Back Jacket
Faux Leather Seat with Mesh Back
Stain repellent

NOTE: CAL 133 is available on SCT-20 models only.
To specify, change the 4th digit to **1**; **Example:** SCT-10-0011
To specify, change the 4th digit to **1** and 5th digit to **1**; **Example:** SCT-11-0011
To specify, change the 4th digit to **3**; **Example:** SCT-30-0011
To specify, add **P** to end of the product number; **Example:** SCT-20-0011P (add **\$38.53** list)

NOTE: Stain repellent is available on SCT-20 and SCT-22 models only.

Very Task

Task Stool with 4D Arms



SCTC-20-7011

Dimensions

- *SH: 20-28"
(508mm-711mm)
- H: 43-51"
(1092mm-1295mm)
- D: 26"(660mm)
- W: 27"(686mm)
- *SW: 19"(483mm)

* Measurements taken with the BIFMA chair measuring device.

Features

- Back: Soft mesh or mesh back with upholstered back jacket.
- Seat: Standard upholstered foam (3 lbs. polyurethane foam construction).
- Seat Depth Adjustment: Standard adjustable range 16"-19" (406mm-483mm).
- Base: Plastic base or optional painted five-star aluminum or polished aluminum base.
- Arms: 4D with soft arm caps. Arm adjusts up and down, side to side.
- Mechanism: Balanced 3-point tilt; standard tilt tension.
- Back Lock: Single position upright back lock.
- Optional Asymmetrical Lumbar Adjustment: 4"(102mm) height adjustment; support level can be adjusted independently for right or left hand side of users body.
- Casters: Standard with hard black or two-tone casters; optional soft casters.
- Adjustable height foot ring.
- COM yardage / COL square footage:
 - Mesh back model: 0.83/20
 - Mesh back/upholstered back jacket: 1.5/40

NOTE: When specifying a back jacket; must also specify mesh surface color for outside of back. Back jacket is not field retrofittable. To add a back jacket in the field, see e-Parts for replacement back with an attached jacket.

To Order, Specify:

- 1) Product number, including:

1 Base/Caster Option:

Aluminum Base

- 1** Aluminum Std. Base, Hard Caster
- 2** Aluminum Std. Base, Soft Caster
- T** Aluminum Std. Base, Two-Tone Casters

Plastic Base

- 5** Plastic Std. Base, Hard Caster
- 6** Plastic Std. Base, Soft Caster
- P** Plastic Std. Base, Two-Tone Casters

- 2) Fabric surface and color (seat).
- 3) Mesh surface and color (back).
- 4) Back Jacket (if applicable) Fabric surface and color.
- 5) Trim color (plastic components) (arm caps, control cover, adjustment levers, 4D or height adjustable arm uprights).

Note: If TR-UFM is specified, arm caps and adjustment levers default to TR-7 Fog. (Add **\$94.04** list for TR-UFM Snow.)

- 6) Frame trim color (aluminum components - underside of chair).
- 7) Base trim color (plastic or aluminum) dependent upon base style selected; TR-UFM Snow (plastic) and TR-FS Snowfall (aluminum) not available.

Note: If PM-P Polished Aluminum is selected for aluminum frame components (#6) or aluminum base (#7), or both, a total upcharge of **\$192.63** list will apply.

Very Task

Task Stool with 4D Arms

Upholstered Seat Adjustments	Number ①	Fabric Grade								Leather Grade A	Leather Grade B
		A	B	C	D	E	F	G	H		
Plastic Base											
Mesh Back/Back Lock	SCTC-20-701	\$1376.91	\$1411.70	\$1448.99	\$1466.39	\$1481.30	\$1513.62	\$1543.44	\$1622.98	\$1693.81	\$1848.92
Upholstered Back Jacket/Back Lock	SCTC-22-701	1507.40	1576.98	1651.56	1686.36	1716.18	1780.82	1840.46	1999.54	2141.20	2451.42
Plastic Base with Lumbar Adjustment											
Mesh Back/Back Lock	SCTC-20-711	\$1463.91	\$1498.70	\$1535.99	\$1553.39	\$1568.30	\$1600.62	\$1630.44	\$1709.98	\$1780.81	\$1935.92
Upholstered Back Jacket/Back Lock	SCTC-22-711	1594.40	1663.98	1738.56	1773.36	1803.18	1867.82	1927.46	2086.54	2228.20	2538.42
Aluminum Base											
Mesh Back/Back Lock	SCTC-20-701	\$1439.05	\$1473.84	\$1511.13	\$1528.53	\$1543.44	\$1575.76	\$1605.58	\$1685.12	\$1755.95	\$1911.06
Upholstered Back Jacket/Back Lock	SCTC-22-701	1569.54	1639.12	1713.70	1748.50	1778.32	1842.96	1902.60	2061.68	2203.34	2513.56
Aluminum Base with Lumbar Adjustment											
Mesh Back/Back Lock	SCTC-20-711	\$1526.05	\$1560.84	\$1598.13	\$1615.53	\$1630.44	\$1662.76	\$1692.58	\$1772.12	\$1842.95	\$1998.06
Upholstered Back Jacket/Back Lock	SCTC-22-711	1656.54	1726.12	1800.70	1835.50	1865.32	1929.96	1989.60	2148.68	2290.34	2600.56

The following options require modification of the product number.

CAL 133

To specify, add **F** to the end of the product number; **Example:** SCTC-20-7011F (add **\$146.66** list)

NOTE: CAL 133 is available on SCTC-20 models only.

Leather Seat with Mesh Back

To specify, change the 5th digit to **1**; **Example:** SCTC-10-0011

Leather Seat with Leather Upholstered Back Jacket

To specify, change the 5th digit to **1** and 6th digit to **1**; **Example:** SCTC-11-0011

Faux Leather Seat with Mesh Back

To specify, change the 5th digit to **3**; **Example:** SCTC-30-0011

Stain repellent

To specify, add **P** to end of the product number; **Example:** SCTC-20-0011P (add **\$38.53** list)

NOTE: Stain repellent is available on SCTC-20 and SCTC-22 models only.

Very Task

Task Stool with Height Adjustable Arms



SCTC-20-4011

Dimensions

- *SH: 20-28"
(508mm-711mm)
- H: 43-51"
(1092mm-1295mm)
- D: 26"(660mm)
- W: 27"(686mm)
- *SW: 19"(483mm)

* Measurements taken with the BIFMA chair measuring device.

Features

- Back: Soft mesh only or mesh back with upholstered back jacket.
- Seat: Standard upholstered foam (3 lbs. polyurethane foam construction).
- Seat Depth Adjustment: Standard adjustable range 16"-19" (406mm-483mm).
- Base: Plastic base or optional painted five-star aluminum or polished aluminum base.
- Arms: Height-adjustable arms with plastic uprights (black or fog) with soft arm caps.
- Mechanism: Balanced 3-point tilt; standard tilt tension.
- Back Lock: Single position upright back lock.
- Optional Asymmetrical Lumbar Adjustment: 4"(102mm) height adjustment; support level can be adjusted independently for right or left hand side of users body.
- Casters: Standard with hard black or two-tone casters; optional soft casters.
- Adjustable height foot ring.
- COM yardage / COL square footage:
 - Mesh back model: 0.83/20
 - Mesh back/upholstered back jacket: 1.5/40

NOTE: When specifying a back jacket; must also specify mesh surface color for outside of back. Back jacket is not field retrofittable. To add a back jacket in the field, see e-Parts for replacement back with an attached jacket.

To Order, Specify:

- 1) Product number, including:

1 Base/Caster Option:

Aluminum Base

- 1** Aluminum Std. Base, Hard Caster
- 2** Aluminum Std. Base, Soft Caster
- T** Aluminum Std. Base, Two-Tone Casters

Plastic Base

- 5** Plastic Std. Base, Hard Caster
- 6** Plastic Std. Base, Soft Caster
- P** Plastic Std. Base, Two-Tone Casters

- 2) Fabric surface and color (seat).
- 3) Mesh surface and color (back).
- 4) Back Jacket (if applicable) Fabric surface and color.
- 5) Trim color (plastic components) (arm caps, control cover, adjustment levers, 4D or height adjustable arm uprights).

Note: If TR-UFM is specified, arm caps and adjustment levers default to TR-7 Fog. (Add **\$94.04** list for TR-UFM Snow.)

- 6) Frame trim color (aluminum components - underside of chair).
- 7) Base trim color (plastic or aluminum) dependent upon base style selected; TR-UFM Snow (plastic) and TR-FS Snowfall (aluminum) not available.

Note: If PM-P Polished Aluminum is selected for aluminum frame components (#6) or aluminum base (#7), or both, a total upcharge of **\$192.63** list will apply.

Very Task

Task Stool with Height Adjustable Arms

Upholstered Foam Seat Adjustments	Number ①	Fabric Grade								Leather Grade A	Leather Grade B
		A	B	C	D	E	F	G	H		
Plastic Base											
Mesh Back/Back Lock	SCTC-20-401	\$1314.77	\$1349.56	\$1386.85	\$1404.25	\$1419.16	\$1451.48	\$1481.30	\$1560.84	\$1631.67	\$1786.78
Upholstered Back Jacket/Back Lock	SCTC-22-401	1445.26	1514.84	1589.42	1624.22	1654.04	1718.68	1778.32	1937.40	2079.06	2389.28
Plastic Base with Lumbar Adjustment											
Mesh Back/Back Lock	SCTC-20-411	\$1401.77	\$1436.56	\$1473.85	\$1491.25	\$1506.16	\$1538.48	\$1568.30	\$1647.84	\$1718.67	\$1873.78
Upholstered Back Jacket/Back Lock	SCTC-22-411	1532.26	1601.84	1676.42	1711.22	1741.04	1805.68	1865.32	2024.40	2166.06	2476.28
Aluminum Base											
Mesh Back/Back Lock	SCTC-20-401	\$1376.91	\$1411.70	\$1448.99	\$1466.39	\$1481.30	\$1513.62	\$1543.44	\$1622.98	\$1693.81	\$1848.92
Upholstered Back Jacket/Back Lock	SCTC-22-401	1507.40	1576.98	1651.56	1686.36	1716.18	1780.82	1840.46	1999.54	2141.20	2451.42
Aluminum Base with Lumbar Adjustment											
Mesh Back/Back Lock	SCTC-20-411	\$1463.91	\$1498.70	\$1535.99	\$1553.39	\$1568.30	\$1600.62	\$1630.44	\$1709.98	\$1780.81	\$1935.92
Upholstered Back Jacket/Back Lock	SCTC-22-411	1594.40	1663.98	1738.56	1773.36	1803.18	1867.82	1927.46	2086.54	2228.20	2538.42

The following options require modification of the product number.

CAL 133

To specify, add **F** to the end of the product number; **Example:** SCTC-20-4011F (add **\$146.66** list)

NOTE: CAL 133 is available on SCTC-20 models only.

Leather Seat with Mesh Back

To specify, change the 5th digit to **1**; **Example:** SCTC-10-4011

Leather Seat with Leather Upholstered Back Jacket

To specify, change the 5th digit to **1** and 6th digit to **1**; **Example:** SCTC-11-4011

Faux Leather Seat with Mesh Back

To specify, change the 5th digit to **3**; **Example:** SCTC-30-4011

Stain repellent

To specify, add **P** to end of the product number; **Example:** SCTC-20-4011P (add **\$38.53** list)

NOTE: Stain repellent is available on SCTC-20 and SCTC-22 models only.

Very Task

Task Stool with Fixed Arms



SCTC-20-1011

Dimensions

- *SH: 20-28"
(508mm-711mm)
- H: 43-51"
(1092mm-1295mm)
- D: 26"(660mm)
- W: 27"(686mm)
- *SW: 19"(483mm)

* Measurements taken with the BIFMA chair measuring device.

Features

- Back: Soft mesh only or mesh back with upholstered back jacket.
- Seat: Standard upholstered foam (3 lbs. polyurethane foam construction).
- Seat Depth Adjustment: Standard adjustable range 16"-19" (406mm-483mm).
- Seat Type: Standard adjustable 3"(76mm) range.
- Base: Plastic base or optional painted five-star aluminum or polished aluminum base.
- Arms: Fixed height arms with aluminum uprights in either painted or polished, soft arm caps.
- Mechanism: Balanced 3-point tilt; standard tilt tension.
- Back Lock: Single position upright back lock.
- Optional Asymmetrical Lumbar Adjustment: 4"(102mm) height adjustment; support level can be adjusted independently for right or left hand side of users body.
- Casters: Standard with hard black or two-tone casters; optional soft casters.
- Adjustable height foot ring.
- COM yardage / COL square footage:
Mesh back model: 0.83/20
Mesh back/upholstered back jacket: 1.5/40

NOTE: When specifying a back jacket; must also specify mesh surface color for outside of back. Back jacket is not field retrofittable. To add a back jacket in the field, see e-Parts for replacement back with an attached jacket.

To Order, Specify:

1) Product number, including:

1 Base/Caster Option:

Aluminum Base

- 1** Aluminum Std. Base, Hard Caster
- 2** Aluminum Std. Base, Soft Caster
- T** Aluminum Std. Base, Two-Tone Casters

Plastic Base

- 5** Plastic Std. Base, Hard Caster
- 6** Plastic Std. Base, Soft Caster
- P** Plastic Std. Base, Two-Tone Casters

2) Fabric surface and color (seat).

3) Mesh surface and color (back).

4) Back Jacket (if applicable) Fabric surface and color.

5) Trim color (plastic components) (arm caps, control cover, adjustment levers, 4D or height adjustable arm uprights).

Note: If TR-UFM is specified, arm caps and adjustment levers default to TR-7 Fog. (Add **\$94.04** list for TR-UFM Snow.)

6) Frame trim color (aluminum components - underside of chair).

7) Base trim color (plastic or aluminum) dependent upon base style selected; TR-UFM Snow (plastic) and TR-FS Snowfall (aluminum) not available.

Note: If PM-P Polished Aluminum is selected for aluminum frame components (#6) or aluminum base (#7), or both, a total upcharge of **\$193.63** list will apply.

Very Task

Task Stool with Fixed Arms

Upholstered Foam Seat Adjustments	Number	①	Fabric Grade								Leather Grade A	Leather Grade B
			A	B	C	D	E	F	G	H		
Plastic Base												
Mesh Back/Back Lock	SCTC-20-101	■	\$1302.34	\$1337.13	\$1374.42	\$1391.82	\$1406.73	\$1439.05	\$1468.87	\$1548.41	\$1619.24	\$1774.35
Upholstered Back Jacket/Back Lock	SCTC-22-101	■	1432.83	1502.41	1576.99	1611.79	1641.61	1706.25	1765.89	1924.97	2066.63	2376.85
Plastic Base with Lumbar Adjustment												
Mesh Back/Back Lock	SCTC-20-111	■	\$1389.34	\$1424.13	\$1461.42	\$1478.82	\$1493.73	\$1526.05	\$1555.87	\$1635.41	\$1706.24	\$1861.35
Upholstered Back Jacket/Back Lock	SCTC-22-111	■	1519.83	1589.41	1663.99	1698.79	1728.61	1793.25	1852.89	2011.97	2153.63	2463.85
Aluminum Base												
Mesh Back/Back Lock	SCTC-20-101	■	\$1364.48	\$1399.27	\$1436.56	\$1453.96	\$1468.87	\$1501.19	\$1531.01	\$1610.55	\$1681.38	\$1836.49
Upholstered Back Jacket/Back Lock	SCTC-22-101	■	1494.97	1564.55	1639.13	1673.93	1703.75	1768.39	1828.03	1987.11	2128.77	2438.99
Aluminum Base with Lumbar Adjustment												
Mesh Back/Back Lock	SCTC-20-111	■	\$1451.48	\$1486.27	\$1523.56	\$1540.96	\$1555.87	\$1588.19	\$1618.01	\$1697.55	\$1768.38	\$1923.49
Upholstered Back Jacket/Back Lock	SCTC-22-111	■	1581.97	1651.55	1726.13	1760.93	1790.75	1855.39	1915.03	2074.11	2215.77	2525.99

The following options require modification of the product number.

CAL 133

To specify, add **F** to the end of the product number; **Example:** SCTC-20-1011F (add **\$146.66** list)

NOTE: CAL 133 is available on SCTC-20 models only.

Leather Seat with Mesh Back

To specify, change the 5th digit to **1**; **Example:** SCTC-10-1011

Leather Seat with Leather Upholstered Back Jacket

To specify, change the 5th digit to **1** and 6th digit to **1**; **Example:** SCTC-11-1011

Faux Leather Seat with Mesh Back

To specify, change the 5th digit to **3**; **Example:** SCTC-30-1011

Stain repellent

To specify, add **P** to end of the product number; **Example:** SCTC-20-1011P (add **\$38.53** list)

NOTE: Stain repellent is available on SCTC-20 and SCTC-22 models only.

Very Task

Task Stool without Arms



SCTC-20-0011

Dimensions

- *SH: 20-28"
(508mm-711mm)
- H: 43-51"
(1092mm-12958mm)
- D: 26"(660mm)
- W: 27"(686mm)
- *SW: 19"(483mm)

* Measurements taken with the BIFMA chair measuring device.

Features

- Back: Soft mesh only or mesh back with upholstered back jacket.
- Seat: Standard upholstered foam (3 lbs. polyurethane foam construction).
- Seat Depth Adjustment: Standard Adjustable range 16"-19" (406mm-483mm).
- Seat Type: Standard adjustable 3"(76mm) range.
- Base: Plastic base or optional painted five-star aluminum or polished aluminum base.
- Mechanism: Balanced 3-point tilt; standard tilt tension.
- Back Lock: Single position upright back lock.
- Optional Asymmetrical Lumbar Adjustment: 4"(102mm) height adjustment; support level can be adjusted independently for right or left hand side of users body.
- Casters: Standard with hard black or two-tone casters; optional soft casters.
- Adjustable height foot ring.
- COM yardage / COL square footage:
Mesh back model: 0.83/20
Mesh back/upholstered back jacket: 1.5/40

NOTE: When specifying a back jacket; must also specify mesh surface color for outside of back. Back jacket is not field retrofittable. To add a back jacket in the field, see e-Parts for replacement back with an attached jacket.

To Order, Specify:

- 1) Product number, including:

1 Base/Caster Option:

Aluminum Base

- 1** Aluminum Std. Base, Hard Caster
- 2** Aluminum Std. Base, Soft Caster
- T** Aluminum Std. Base, Two-Tone Casters

Plastic Base

- 5** Plastic Std. Base, Hard Caster
- 6** Plastic Std. Base, Soft Caster
- P** Plastic Std. Base, Two-Tone Casters

- 2) Fabric surface and color (seat).
 - 3) Mesh surface and color (back).
 - 4) Back Jacket (if applicable) Fabric surface and color.
 - 5) Trim color (plastic components) (arm caps, control cover, adjustment levers, 4D or height adjustable arm uprights).
- Note:** If TR-UFM is specified, arm caps and adjustment levers default to TR-7 Fog. (Add **\$94.04** list for TR-UFM Snow.)
- 6) Frame trim color (aluminum components - underside of chair).
 - 7) Base trim color (plastic or aluminum) dependent upon base style selected; TR-UFM Snow (plastic) and TR-FS Snowfall (aluminum) not available.

Note: If PM-P Polished Aluminum is selected for aluminum frame components (#6) or aluminum base (#7), or both, a total upcharge of **\$192.63** list will apply.

Very Task

Task Stool without Arms

Upholstered Foam Seat Adjustments	Number	①	Fabric Grade								Leather Grade A	Leather Grade B
			A	B	C	D	E	F	G	H		
Plastic Base												
Mesh Back/Back Lock	SCTC-20-001		\$1159.43	\$1194.22	\$1231.51	\$1248.91	\$1263.82	\$1296.14	\$1325.96	\$1405.50	\$1476.33	\$1631.44
Upholstered Back Jacket/Back Lock	SCTC-22-001		1289.92	1359.50	1434.08	1468.88	1498.70	1563.34	1622.98	1782.06	1923.72	2233.94
Plastic Base with Lumbar Adjustment												
Mesh Back/Back Lock	SCTC-20-011		\$1246.43	\$1281.22	\$1318.51	\$1335.91	\$1350.82	\$1383.14	\$1412.96	\$1492.50	\$1563.33	\$1718.44
Upholstered Back Jacket/Back Lock	SCTC-22-011		1376.92	1446.50	1521.08	1555.88	1585.70	1650.34	1709.98	1869.06	2010.72	2320.94
Aluminum Base												
Mesh Back/Back Lock	SCTC-20-001		\$1221.57	\$1256.36	\$1293.65	\$1311.05	\$1325.96	\$1358.28	\$1388.10	\$1467.64	\$1538.47	\$1693.58
Upholstered Back Jacket/Back Lock	SCTC-22-001		1352.06	1421.64	1496.22	1531.02	1560.84	1625.48	1685.12	1844.20	1985.86	2296.08
Aluminum Base with Lumbar Adjustment												
Mesh Back/Back Lock	SCTC-20-011		\$1308.57	\$1343.36	\$1380.65	\$1398.05	\$1412.96	\$1445.28	\$1475.10	\$1554.64	\$1625.47	\$1780.58
Upholstered Back Jacket/Back Lock	SCTC-22-011		1439.06	1508.64	1583.22	1618.02	1647.84	1712.48	1772.12	1931.20	2072.86	2383.08

The following options require modification of the product number.

CAL 133

To specify, add **F** to the end of the product number; **Example:** SCTC-20-0111F (add **\$146.66 list**)

NOTE: CAL 133 is available on SCTC-20 models only.

Leather Seat with Mesh Back

To specify, change the 5th digit to **1**; **Example:** SCTC-10-0011

Leather Seat with Leather Upholstered Back Jacket

To specify, change the 5th digit to **1** and 6th digit to **1**; **Example:** SCTC-11-0011

Faux Leather Seat with Mesh Back

To specify, change the 5th digit to **3**; **Example:** SCTC-30-0011

Stain repellent

To specify, add **P** to end of the product number; **Example:** SCTC-20-0011P (add **\$38.53 list**)

NOTE: Stain repellent is available on SCTC-20 and SCTC-22 models only.

This page intentionally blank

Lively-At-A-Glance

Designer

Steve Nemeth and the Haworth Design Studio

Lively

Lively provides a seating collection that is affordable without compromise. It offers daylong comfort, worry-free quality and a light-scale aesthetic.

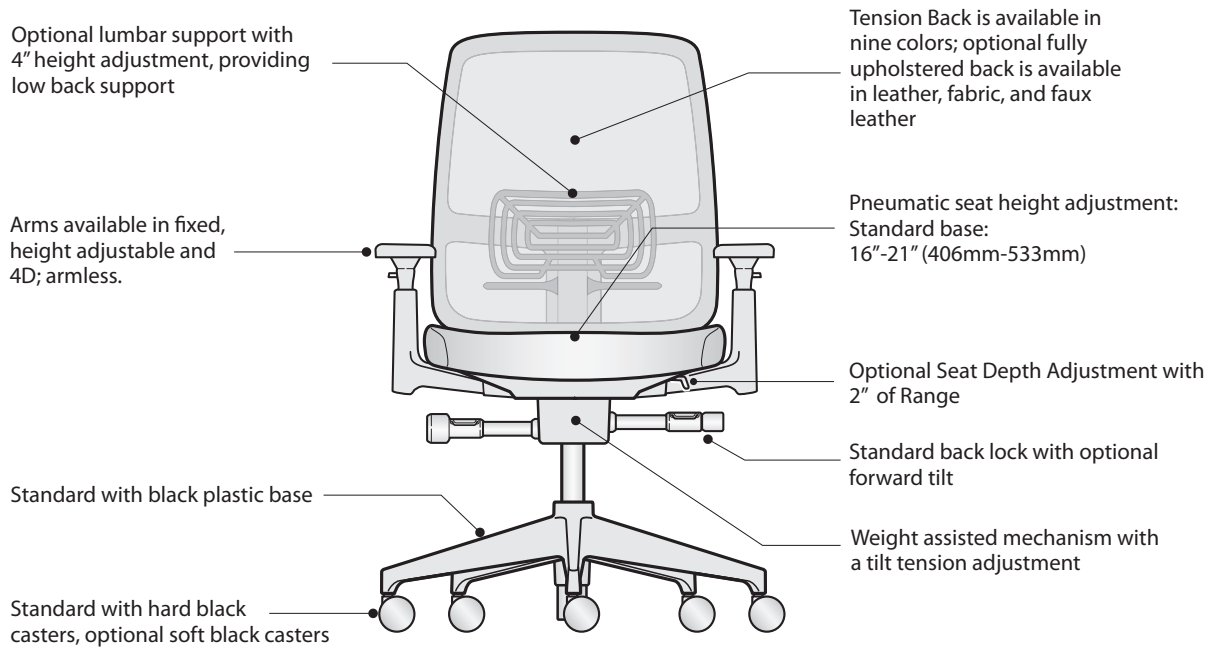

Lively Task

General Specifications

Features and Options (Task Chair)

- Back: Tension back or fully upholstered.
- Seat: Standard upholstered with foam.
- Base: Black plastic.
- Arms: 4D, Height Adjustable, or Fixed arms. Armless model available.
- Mechanism: Weight assisted mechanism with tilt tension adjustment.
- Height Adjustment: Pneumatic.
- Standard back lock.
- Optional Forward Tilt: 5° downward from initial position.
- Optional Adjustable Lumbar: 4" adjustment, flexible support.
- Optional Seat Depth Adjustment: Adjustable range is 16.75"-19"(425mm-483mm).
- Casters: Five-Star base with casters; hard (black) or soft (black).
- Lively Task chairs are warranted for persons up to 325 lbs. for 12 years 24/7.

General Guidelines for Product Specification

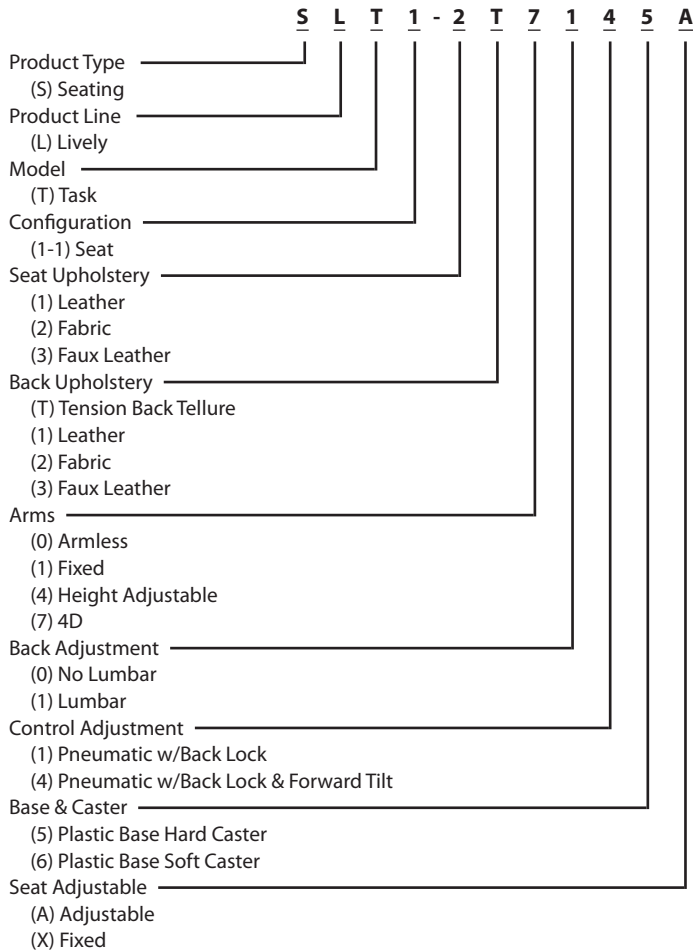

Lively Task

General Specifications

Environmental Factors	<ul style="list-style-type: none"> • Greenguard Gold certified for low emissions. • Lively Task is BIFMA level 2 certified. • Lively is produced in an ISO 14001 certified manufacturing facility. • Haworth will take back Lively chairs after their useful life and recycle the components. Please contact Haworth's Material Recovery Center at (616)393-1215. • Lively has 52% recycled content and is up to 97% recyclable.
COM & COL General Information	<p>To order a COM fabric (Customer's Own Material), contact the Haworth Inquiry Center (1.800.426.8562), your local Haworth dealer, or go to haworth.com/surfaces > COM Library to find out if the COM you have selected has already been tested and approved. The surface collection site also has information on the Haworth+ alliance program with Carnegie, Luna Textiles, and Maharam as well as our industry-leading Pre-Approved COM program.</p> <p>COM fabrics are placed into Grades based on the cost per linear yard. If a fabric's cost exceeds the range of our highest Grade it will be noted as Non-Graded. The product will be priced at Grade A; the COM fabric costs will appear as a separate line item. The fabric charge will be Haworth's purchase cost plus a 4% administrative fee (based on the cost of the fabric). Yardage calculations will include any applicable fabric repeat.</p> <p>COM Leather products will be priced at a leather Grade A; COL costs will appear as a separate line item. The leather costs will be Haworth's purchase cost plus a 4% administrative fee (based on the cost of the leather).</p>
Finishes and Fabrics	<p>A complete listing of finishes and fabrics for Lively seating is available in the surface materials section of the Seating price list.</p>
Shipping Weights (Including packaging)	<ul style="list-style-type: none"> • Chairs with arms: 42 pounds/1 chair per carton • Chairs without arms: 38.8 pounds/1 chair per carton

Lively

General Specifications

STANDARD MOBILITY AND ADJUSTABILITY

Weight Assisted Tilt Tension Mechanism

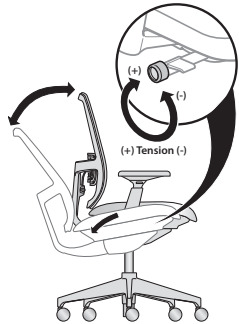

Features:

- Back reclines 24° from the upright position.
- Responds to users weight in combination with the tilt tension to maximize comfort.

Benefits:

- Comfortable relaxed posture.
- Recline allows for the opening of the users' chest cavity providing good airflow to promote alertness.

Seat Height Adjustment

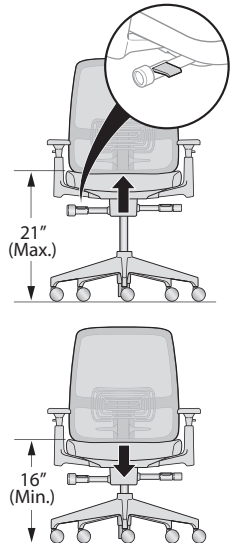

Features:

- Pneumatic seat height adjustment.
- Seat height adjusts 5"(127mm) from 16" to 21"(406mm to 533mm).

Benefits:

- Ensures the comfort of the lower limbs by avoiding pressure on the underside of the thigh caused by a seat pan that is too high, or decreased thigh-to-torso angle if the seat pan is too low.
- Seat height adjustment also is important in setting the proper hand position and allowing for a proper sitting eye height.

Back Lock

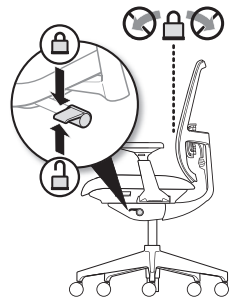

Features:

- Single position Back Lock.

Benefit:

- Allows users to lock the back of the chair in the upright position for tasking application.

Lively

General Specifications

OPTIONAL MOBILITY AND ADJUSTABILITY

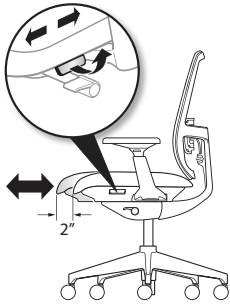
Seat Depth Adjustment**Features:**

- 2" (51mm) of seat depth range.

Benefit:

- Supports the thighs, allows users to rest against the seat back for back support, and avoids pressure on the back of the knees of small to tall users.

Forward Tilt**Feature:**

- Optional forward tilt.
- Seat pan moves downward 5° from initial position.

Benefit:

- Promotes a healthy spinal posture where your back stays in contact with the chair as a user sits on the front of their chair.

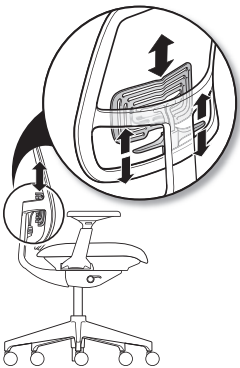
Lumbar Support**Features:**

- Lumbar adjustment adjusts 4" (102mm) in height.

Benefits:

- Lumbar adjustment maintains the natural curvature of the spine at the lower back and allows users to choose the support that feels right for them.

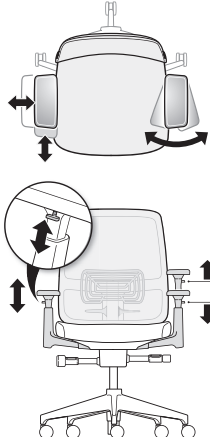
4D Arm**Features:**

- Optional 4D arm.
- Arm adjusts in 4 ways:
 - Height adjustment: 4" (102mm)
 - Side-to-side arm cap adjustment range: 3" (76mm) [1 1/2" (38mm) each arm cap]
 - Front-to-back adjustment range: 3 1/2" (89mm)
 - Pivoting: In 20°; out 20°

Benefits:

- Arms support the muscular system of users' neck and shoulders and proper arm support provides back relief. Arms can be an aid in standing or sitting down.
- Height adjustment accommodates for users with varying elbow rest heights so that users avoid lifting their shoulders or leaning sideways to get arm support.
- Side-to-side adjustment ensures a comfortable resting position for the arms with proper support of the forearm while allowing for easy entry/exit of the chair.
- Front-to-back adjustment adjusts the armrest length, which is important because it allows users to get close to the worksurface while maintaining the effective use of the backrest.
- Pivoting provides proper support of the forearm when performing tasks involving keying and mousing.

Lively

General Specifications

OPTIONAL MOBILITY AND ADJUSTABILITY (continued)

Height Adjustable Arm

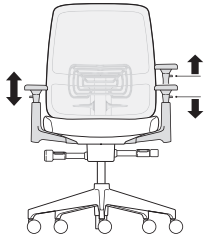

Features:

- Optional height adjustable arms adjust 4"(102mm) vertically.

Benefit:

- Height adjustment accommodates users with varying elbow rest heights so that users avoid lifting their shoulders or leaning sideways to get arm support.
-

Leather Upholstery



Seat:

- Stitched double seams. Vertically in the center and on the edges of the seat cushion.

Back:

- Vertical stitched double seams on the upholstered back with leather or Customer's Own Leather (COL).

Lively Value Model

Task Chair with 4D Arms



SLT1-2T-7115A

Dimensions*

*SH: 16"-21"
(406mm-533mm)
H: 36"-41"
(914mm-1041mm)
D: 24"(610mm)
W: 28"(711mm)
*SW: 19"(483mm)

* All measurements taken with the BIFMA chair measuring device.

Features

- Back: Tension back.
- Tension back is fabric suspended between a frame.
- Seat: Standard upholstered foam.
- Base: Black plastic base.
- Arms: 4D with soft arm caps. Arm adjusts up and down, side to side, front to back and pivot.
- Mechanism: Weight assisted mechanism with tilt tension adjustment.
- Back-Lock: Single position upright back lock.
- Seat Depth Adjustment: 16.75"-19"(425mm-483mm).
- Optional Adjustable Lumbar: 4"(102mm) height adjustment, flexible lumbar support.
- Casters: Hard black casters.

To Order, Specify:

- 1) Product number.
- 2) Seat surface/color: 3A-18 Tellure - Black
- 3) Tension Back: 3T-18 Black
- 4) Trim color: TR-F Black

Note: No changes to specification.
No COM or Tailored Solutions.

Number

SLT1-2T-7115A

Price**\$688.38**

Lively

Task Chair with 4D Arms



SLT1-2T-7115A

Dimensions

- *SH: 16"-21"
(406mm-533mm)
- H: 36"-41"
(914mm-1041mm)
- D: 24"(610mm)
- W: 28"(711mm)
- *SW: 19"(483mm)

* All measurements taken with the BIFMA chair measuring device.

Features

- Back: Tension back or fully upholstered.
- Tension back is fabric suspended between a frame.
- Fully upholstered back features a slim foam pad.
- Seat: Standard upholstered foam.
- Base: Black plastic base.
- Arms: 4D with soft arm caps. Arm adjusts up and down, side to side, front to back and pivot.
- Mechanism: Weight assisted mechanism with tilt tension adjustment.
- Back-Lock: Single position upright back lock.
- Optional Forward Tilt: 5° downward from initial position.
- Optional Seat Depth Adjustment: 16.75"-19"(425mm-483mm).
- Optional Adjustable Lumbar: 4"(102mm) height adjustment, flexible lumbar support.
- Casters: Standard with hard black casters; optional soft casters.
- COM yardage / COL square footage:
Tension back model: 0.66/4.1
Fully upholstered model: 0.75/8.2

To Order, Specify:

- 1) Product number, including;

① Seat or Seat Pad Option:

- Fixed Seat
- Adjustable Seat, add **\$35.44** list

- 2) Surface and color (seat).
- 3) Surface and color for tension back material (back).
- 4) Surface and color for fabric on fully upholstered (back).
- 5) Base.

Note: When specifying a fully upholstered chair; must also specify a tension back color for outside of back.

Upholstered Seat Adjustments	Number ①	Fabric Grade								Leather Grade A	Leather Grade B
		A	B	C	D	E	F	G	H		
No Lumbar Adjustment - Tension Back											
Back Lock	SLT1-2T-7015	\$760.63	\$793.69	\$829.13	\$845.68	\$859.83	\$890.56	\$918.90	\$994.50	\$1061.81	\$1209.45
Forward Tilt/Back Lock	SLT1-2T-7045	796.07	829.13	864.57	881.12	895.27	926.00	954.34	1029.94	1097.25	1244.89
No Lumbar Adjustment - Fully Upholstered											
Back Lock	SLT1-22-7015	\$878.74	\$944.86	\$1015.74	\$1048.84	\$1077.14	\$1138.60	\$1195.28	\$1346.48	\$1481.10	\$1776.38
Forward Tilt/Back Lock	SLT1-22-7045	914.18	980.30	1051.18	1084.28	1112.58	1174.04	1230.72	1381.92	1516.54	1811.82
Lumbar Adjustment - Tension Back											
Back Lock	SLT1-2T-7115	\$819.68	\$852.74	\$888.18	\$904.73	\$918.88	\$949.61	\$977.95	\$1053.55	\$1120.86	\$1268.50
Forward Tilt/Back Lock	SLT1-2T-7145	855.12	888.18	923.62	940.17	954.32	985.05	1013.39	1088.99	1156.30	1303.94
Lumbar Adjustment - Fully Upholstered											
Back Lock	SLT1-22-7115	\$937.79	\$1003.91	\$1074.79	\$1107.89	\$1136.19	\$1197.65	\$1254.33	\$1405.53	\$1540.15	\$1835.43
Forward Tilt/Back Lock	SLT1-22-7145	973.23	1039.35	1110.23	1143.33	1171.63	1233.09	1289.77	1440.97	1575.59	1870.87

The following options require modification of the product number.

- Soft Casters
- CAL 133
- Stain repellent

- To specify, change the 10th digit from a **5** to a **6**; **Example:** SLT1-22-7016A
- To specify, add **F** to the end of the product number; **Example:** SLT1-22-7015AF (add **\$139.38** list)
- To specify, add **P** to end of the product number; **Example:** SLT1-22-7015AP (add **\$36.61** list)

NOTE: Stain repellent is available on SLT1-2T and SLT1-22 models only.

- Leather Seat with Tension Back
- Leather Seat with Leather Back
- Faux Leather Seat with Tension Back

- To specify, change the 5th digit to **1**; **Example:** SLT1-1T-7115A
- To specify, change the 5th digit to **1** and 6th digit to **1**; **Example:** SLT1-11-7115A
- To specify, change the 5th digit to **3**; **Example:** SLT1-3T-7115A

Lively

Task Chair with Height Adjustable Arms



SLT1-2T-4115A

Dimensions

*SH: 16"-21"
(406mm-533mm)
H: 36"-41"
(914mm-1041mm)
D: 24"(610mm)
W: 28"(711mm)
*SW: 19"(483mm)

* All measurements taken with the BIFMA chair measuring device.

Features

- Back: Tension back or fully upholstered.
- Tension back is fabric suspended between a frame.
- Fully upholstered back features a slim foam pad.
- Seat: Standard upholstered foam.
- Base: Black plastic base.
- Arms: Height adjustable arms with plastic uprights (black) with soft arm caps.
- Mechanism: Weight assisted mechanism with tilt tension adjustment.
- Back-Lock: Single position upright back lock.
- Optional Forward Tilt: 5° downward from initial position.
- Optional Seat Depth Adjustment: 16.75"-19"(425mm-483mm).
- Optional Adjustable Lumbar: 4"(102mm) height adjustment, flexible lumbar support.
- Casters: Standard with hard black casters; optional soft casters.
- COM yardage / COL square footage:
Tension back model: 0.66/4.1
Fully upholstered model: 0.75/8.2

To Order, Specify:

1) Product number, including;

1 Seat or Seat Pad Option:

- X Fixed Seat
 A Adjustable Seat, add **\$35.44** list

2) Surface and color (seat).

3) Surface and color for tension back material (back).

4) Surface and color for fabric on fully upholstered (back).

5) Base.

Note: When specifying a fully upholstered chair; must also specify a tension back color for outside of back.

Upholstered Seat Adjustments	Number ①	Fabric Grade								Leather Grade A	Leather Grade B
		A	B	C	D	E	F	G	H		
No Lumbar Adjustment - Tension Back											
Back Lock	SLT1-2T-4015	\$731.10	\$764.16	\$799.60	\$816.15	\$830.30	\$861.03	\$889.37	\$964.97	\$1032.28	\$1179.92
Forward Tilt/Back Lock	SLT1-2T-4045	766.54	799.60	835.04	851.59	865.74	896.47	924.81	1000.41	1067.72	1215.36
No Lumbar Adjustment - Fully Upholstered											
Back Lock	SLT1-22-4015	\$849.21	\$915.33	\$986.21	\$1019.31	\$1047.61	\$1109.07	\$1165.75	\$1316.95	\$1451.57	\$1746.85
Forward Tilt/Back Lock	SLT1-22-4045	884.65	950.77	1021.65	1054.75	1083.05	1144.51	1201.19	1352.39	1487.01	1782.29
Lumbar Adjustment - Tension Back											
Back Lock	SLT1-2T-4115	\$790.15	\$823.21	\$858.65	\$875.20	\$889.35	\$920.08	\$948.42	\$1024.02	\$1091.33	\$1238.97
Forward Tilt/Back Lock	SLT1-2T-4145	825.59	858.65	894.09	910.64	924.79	955.52	983.86	1059.46	1126.77	1274.41
Lumbar Adjustment - Fully Upholstered											
Back Lock	SLT1-22-4115	\$908.26	\$974.38	\$1045.26	\$1078.36	\$1106.66	\$1168.12	\$1224.80	\$1376.00	\$1510.62	\$1805.90
Forward Tilt/Back Lock	SLT1-22-4145	943.70	1009.82	1080.70	1113.80	1142.10	1203.56	1260.24	1411.44	1546.06	1841.34

The following options require modification of the product number.

Soft Casters
CAL 133
Stain repellent

To specify, change the 10th digit from a **5** to a **6**; **Example:** SLT1-22-4016A
To specify, add **F** to the end of the product number; **Example:** SLT1-22-4015AF (add **\$139.38** list)
To specify, add **P** to end of the product number; **Example:** SLT1-22-4015AP (add **\$36.61** list)

NOTE: Stain repellent is available on SLT1-2T and SLT1-22 models only.

Leather Seat with Tension Back
Leather Seat with Leather Back
Faux Leather Seat with Tension Back

To specify, change the 5th digit to **1**; **Example:** SLT1-1T-4115A
To specify, change the 5th digit to **1** and 6th digit to **1**; **Example:** SLT1-11-4115A
To specify, change the 5th digit to **3**; **Example:** SLT1-3T-4115A

Lively

Task Chair with Fixed Arms



SLT1-2T-1115A

Dimensions

- *SH: 16"-21"
(406mm-533mm)
- H: 36"-41"
(914mm-1041mm)
- D: 24"(610mm)
- W: 28"(711mm)
- *SW: 19"(483mm)

* All measurements taken with the BIFMA chair measuring device.

Features

- Back: Tension back or fully upholstered.
- Tension back is fabric suspended between a frame.
- Fully upholstered back features a slim foam pad.
- Seat: Standard upholstered foam.
- Base: Black plastic base.
- Arms: Black plastic fixed arms.
- Mechanism: Weight assisted mechanism with tilt tension adjustment.
- Back-Lock: Single position upright back lock.
- Optional Forward Tilt: 5° downward from initial position.
- Optional Seat Depth Adjustment: 16.75"-19"(425mm-483mm).
- Optional Adjustable Lumbar: 4"(102mm) height adjustment, flexible lumbar support.
- Casters: Standard with hard black casters; optional soft casters.
- COM yardage / COL square footage:
Tension back model: 0.66/4.1
Fully upholstered model: 0.75/8.2

To Order, Specify:

1) Product number, including;

① Seat or Seat Pad Option:

- Fixed Seat
- Adjustable Seat, add **\$35.44** list

2) Surface and color (seat).

3) Surface and color for tension back material (back).

4) Surface and color for fabric on fully upholstered (back).

5) Base.

Note: When specifying a fully upholstered chair; must also specify a tension back color for outside of back.

Upholstered Seat Adjustments	Number ①	Fabric Grade		C	D	E	F	G	H	Leather Grade A	Leather Grade B
		A	B								
No Lumbar Adjustment - Tension Back											
Back Lock	SLT1-2T-1015	\$677.95	\$711.01	\$ 746.45	\$ 763.00	\$ 777.15	\$ 807.88	\$ 836.22	\$ 911.82	\$ 979.13	\$1126.77
Forward Tilt/Back Lock	SLT1-2T-1045	713.39	746.45	781.89	798.44	812.59	843.32	871.66	947.26	1014.57	1162.21
No Lumbar Adjustment - Fully Upholstered											
Back Lock	SLT1-22-1015	\$796.06	\$862.18	\$ 933.06	\$ 966.16	\$ 994.46	\$1055.92	\$1112.60	\$1263.80	\$1398.42	\$1693.70
Forward Tilt/Back Lock	SLT1-22-1045	831.50	897.62	968.50	1001.60	1029.90	1091.36	1148.04	1299.24	1433.86	1729.14
Lumbar Adjustment - Tension Back											
Back Lock	SLT1-2T-1115	\$737.00	\$770.06	\$ 805.50	\$ 822.05	\$ 836.20	\$ 866.93	\$ 895.27	\$ 970.87	\$1038.18	\$1185.82
Forward Tilt/Back Lock	SLT1-2T-1145	772.44	805.50	840.94	857.49	871.64	902.37	930.71	1006.31	1073.62	1221.26
Lumbar Adjustment - Fully Upholstered											
Back Lock	SLT1-22-1115	\$855.11	\$921.23	\$ 992.11	\$1025.21	\$1053.51	\$1114.97	\$1171.65	\$1322.85	\$1457.47	\$1752.75
Forward Tilt/Back Lock	SLT1-22-1145	890.55	956.67	1027.55	1060.65	1088.95	1150.41	1207.09	1358.29	1492.91	1788.19

The following options require modification of the product number.

- Soft Casters
- CAL 133
- Stain repellent

To specify, change the 10th digit from a **5** to a **6**; **Example:** SLT1-22-1016A
 To specify, add **F** to the end of the product number; **Example:** SLT1-22-1015AF (add **\$139.38** list)
 To specify, add **P** to end of the product number; **Example:** SLT1-22-1015AP (add **\$36.61** list)

NOTE: Stain repellent is available on SLT1-2T and SLT1-22 models only.

- Leather Seat with Tension Back
- Leather Seat with Leather Back
- Faux Leather Seat with Tension Back

To specify, change the 5th digit to **1**; **Example:** SLT1-1T-1115A
 To specify, change the 5th digit to **1** and 6th digit to **1**; **Example:** SLT1-11-1115A
 To specify, change the 5th digit to **3**; **Example:** SLT1-3T-1115A

Lively

Task Chair without Arms



SLT1-2T-0115A

Dimensions

- *SH: 16"-21"
(406mm-533mm)
- H: 36"-41"
(914mm-1041mm)
- D: 24"(610mm)
- W: 28"(711mm)
- *SW: 19"(483mm)

* All measurements taken with the BIFMA chair measuring device.

Features

- Back: Tension back or fully upholstered.
- Tension back is fabric suspended between a frame.
- Fully upholstered back features a slim foam pad.
- Seat: Standard upholstered foam.
- Base: Black plastic base.
- Mechanism: Weight assisted mechanism with tilt tension adjustment.
- Back-Lock: Single position upright back lock.
- Optional Forward Tilt: 5° downward from initial position.
- Optional Seat Depth Adjustment: 16.75"-19"(425mm-483mm).
- Optional Adjustable Lumbar: 4"(102mm) height adjustment, flexible lumbar support.
- Casters: Standard with hard black casters; optional soft casters.
- COM yardage / COL square footage:
Tension back model: 0.66/4.1
Fully upholstered model: 0.75/8.2

To Order, Specify:

- 1) Product number, including;
 - 1 Seat or Seat Pad Option:**
 - Fixed Seat
 - Adjustable Seat, add **\$35.44** list
- 2) Surface and color (seat).
- 3) Surface and color for tension back material (back).
- 4) Surface and color for fabric on fully upholstered (back).
- 5) Base.

Note: When specifying a fully upholstered chair; must also specify a tension back color for outside of back.

Upholstered Seat Adjustments	Number ①	Fabric Grade								Leather Grade A	Leather Grade B
		A	B	C	D	E	F	G	H		
No Lumbar Adjustment - Tension Back											
Back Lock	SLT1-2T-0015	\$618.90	\$651.96	\$687.40	\$ 703.95	\$ 718.10	\$ 748.83	\$ 777.17	\$ 852.77	\$ 920.08	\$1067.72
Forward Tilt/Back Lock	SLT1-2T-0045	654.34	687.40	722.84	739.39	753.54	784.27	812.61	888.21	955.52	1103.16
No Lumbar Adjustment - Fully Upholstered											
Back Lock	SLT1-22-0015	\$737.01	\$803.13	\$874.01	\$ 907.11	\$ 935.41	\$ 996.87	\$1053.55	\$1204.75	\$1339.37	\$1634.65
Forward Tilt/Back Lock	SLT1-22-0045	772.45	838.57	909.45	942.55	970.85	1032.31	1088.99	1240.19	1374.81	1670.09
Lumbar Adjustment - Tension Back											
Back Lock	SLT1-2T-0115	\$677.95	\$711.01	\$746.45	\$ 763.00	\$ 777.15	\$ 807.88	\$ 836.22	\$ 911.82	\$ 979.13	\$1126.77
Forward Tilt/Back Lock	SLT1-2T-0145	713.39	746.45	781.89	798.44	812.59	843.32	871.66	947.26	1014.57	1162.21
Lumbar Adjustment - Fully Upholstered											
Back Lock	SLT1-22-0115	\$796.06	\$862.18	\$933.06	\$ 966.16	\$ 994.46	\$1055.92	\$1112.60	\$1263.80	\$1398.42	\$1693.70
Forward Tilt/Back Lock	SLT1-22-0145	831.50	897.62	968.50	1001.60	1029.90	1091.36	1148.04	1299.24	1433.86	1729.14

The following options require modification of the product number.

- Soft Casters
- CAL 133
- Stain repellent

- To specify, change the 10th digit from a 5 to a 6; **Example:** SLT1-22-0016A
- To specify, add **F** to the end of the product number; **Example:** SLT1-22-0015AF (add **\$139.38** list)
- To specify, add **P** to end of the product number; **Example:** SLT1-22-0015AP (add **\$36.61** list)

NOTE: Stain repellent is available on SLT1-2T and SLT1-22 models only.

- Leather Seat with Tension Back
- Leather Seat with Leather Back
- Faux Leather Seat with Tension Back

- To specify, change the 5th digit to 1; **Example:** SLT1-1T-0115A
- To specify, change the 5th digit to 1 and 6th digit to 1; **Example:** SLT1-11-0115A
- To specify, change the 5th digit to 3; **Example:** SLT1-3T-0115A

Lively

Side Chair

With Arms



SLS1-2T-1H



SLS1-2T-11

Dimensions*

SH: 18"(457mm)
 H: 33"(838mm)
 D: 24.5"(622mm)
 W: 21.5"(536mm)
 SW: 19.5"(495mm)

* All measurements taken with the BIFMA chair measuring device.

Features

- Back: Tension back or fully upholstered.
- Tension back is fabric suspended between a frame.
- Fully upholstered back features a slim foam pad.
- Seat: Standard upholstered foam.
- Base: Steel painted in black or metallic silver.
- Arms: Fixed arms with black plastic arm cap.
- Side chair with glides can stack 5 high on the floor.
- Side chair with casters does NOT stack.
- COM yardage / COL square footage:
 Tension back model: 0.75/4.1
 Fully upholstered model: 0.75/8.2

To Order, Specify:

1) Product number, including;

1 Glide or Caster Option:

- K** Felt Glide
- H** Plastic Glide
- 1** Hard Casters add **\$17.71** list
- 2** Soft Casters add **\$17.71** list

2) Surface and color (seat).

3) Surface and color for tension back material (back).

4) Surface and color for fabric on fully upholstered (back).

5) Frame color.

Note: When specifying a fully upholstered chair; must also specify a tension back color for outside of back.

Upholstered Seat	Number ①	Fabric Grade								Leather Grade A	Leather Grade B
		A	B	C	D	E	F	G	H		
Tension Back	SLS1-2T-1 ■	\$435.82	\$470.07	\$506.70	\$523.22	\$538.57	\$569.29	\$598.81	\$676.77	\$594.09	\$ 735.83
Fully Upholstered	SLS1-22-1 ■	453.53	522.03	595.29	628.33	659.03	720.47	779.51	935.43	770.07	1053.55

The following options require modification of the product number.

CAL 133

To specify, add **F** to the end of the product number; **Example:** SLS1-2T-1HF (add **\$67.33** list)

Stain repellent

To specify, add **P** to end of the product number; **Example:** SLS1-22-1HP (add **\$36.61** list)

Leather Seat with Tension Back

To specify, change the 5th digit to **1**; **Example:** SLS1-1T-1H

Leather Seat with Leather Back

To specify, change the 5th digit to **1** and 6th digit to **1**; **Example:** SLS1-11-1H

Faux Leather Seat with Tension Back

To specify, change the 5th digit to **3**; **Example:** SLS1-3T-1H

Lively

Side Chair

Without Arms



SLS1-2T-0H



SLS1-2T-01

Dimensions*

- SH: 18"(457mm)
- H: 33"(838mm)
- D: 24.5"(622mm)
- W: 21.5"(536mm)
- SW: 19.5"(495mm)

* All measurements taken with the BIFMA chair measuring device.

Features

- Back: Tension back or fully upholstered.
- Tension back is fabric suspended between a frame.
- Fully upholstered back features a slim foam pad.
- Seat: Standard upholstered foam.
- Base: Steel painted in black or metallic silver.
- Side chair with glides can stack 5 high on the floor.
- Side chair with casters does NOT stack.
- COM yardage / COL square footage:
Tension back model: 0.75/4.1
Fully upholstered model: 0.75/8.2

To Order, Specify:

1) Product number, including;

1 Glide or Caster Option:

- K** Felt Glide
- H** Plastic Glide
- 1** Hard Casters add **\$17.71** list
- 2** Soft Casters add **\$17.71** list

- 2) Surface and color (seat).
- 3) Surface and color for tension back material (back).
- 4) Surface and color for fabric on fully upholstered (back).
- 5) Frame color.

Note: When specifying a fully upholstered chair; must also specify a tension back color for outside of back.

Upholstered Seat	Number ①	Fabric Grade								Leather Grade A	Leather Grade B
		A	B	C	D	E	F	G	H		
Tension Back	SLS1-2T-0	\$376.77	\$411.02	\$447.65	\$464.17	\$479.52	\$510.24	\$539.76	\$617.72	\$535.04	\$676.78
Fully Upholstered	SLS1-22-0	394.48	462.98	536.24	569.28	599.98	661.42	720.46	876.38	711.02	994.50

The following options require modification of the product number.

- CAL 133 To specify, add **F** to the end of the product number; **Example:** SLS1-2T-0HF (add **\$67.33** list)
- Stain repellent To specify, add **P** to end of the product number; **Example:** SLS1-22-0HP (add **\$36.61** list)
- Leather Seat with Tension Back To specify, change the 5th digit to **1**; **Example:** SLS1-1T-0H
- Leather Seat with Leather Back To specify, change the 5th digit to **1** and 6th digit to **1**; **Example:** SLS1-11-0H
- Faux Leather Seat with Tension Back To specify, change the 5th digit to **3**; **Example:** SLS1-3T-0H

This page intentionally blank

**Features and Options
(Task and Executive)**

- Upholstered seat
- Soft mesh or upholstered back
- Soft mesh consists of chenille, poly-filament blend
- Pneumatic seat-height adjustment
- Optional low-position pneumatic seat-height adjustment: range 15"-18"(381-457mm) (steel base only)
- Optional height-and-depth adjustable lumbar
- Optional 3-position seat-depth adjustment (seat depth range: 16"-18"(406-457mm))
- Back stop, lockable in the upright position
- Tuck-away tilt tension adjustment
- Free-floating forward tilt
- 3-point tilt mechanism
- 3-dimensional arms, loop arms or armless
- Standard soft arm caps, upholstered (fabric or leather) arm caps, or vinyl gel arm caps
- Aluminum five-star base
- Finishes include: powder-coated paint (black or silver) and chrome
- Hard dual-wheel casters for carpeted floors (black)
- Optional soft dual-wheel casters for resilient floor surfaces (black)
- Contoured headrest on executive chair
- All **X99** models meet or exceed all ANSI/BIFMA durability standards for office seating

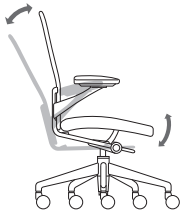
Mobility and Adjustability

- Back reclines 25° from the upright position
- Seat pan moves downward 3° from the initial position
- 3-dimensional arm adjustment
- Arm height adjustment: 4"(102mm)
- Arm cap slide range: 2.4"(61mm)
- Arm cap pivot range: 30° (18° in/12° out)

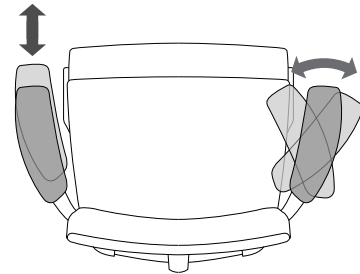
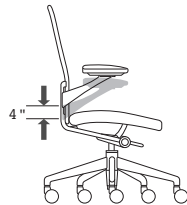

- Height-and-depth adjustable lumbar - mesh or upholstered back
- 4"(102mm) vertical adjustment; 1"(25mm) depth adjustment

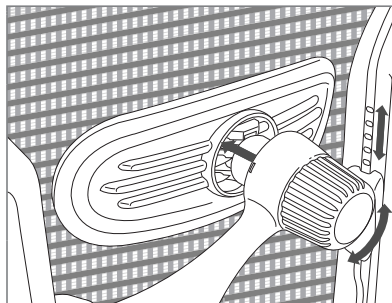
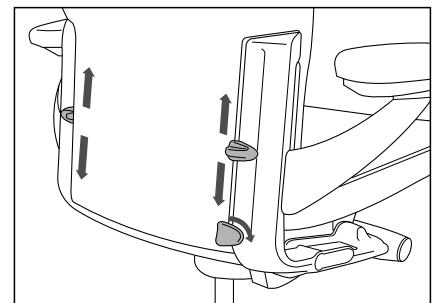
**Lumbar Adjustment, Mesh Back****Lumbar Adjustment, Upholstered Back****Standard Aluminum Base**

X99

General Specifications

- 3-position seat-depth up to 3.5 inches of adjustment

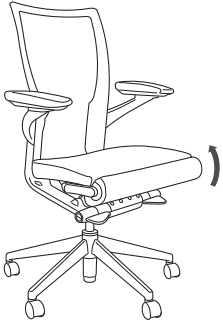

Features and Options (Guest Chair)

- Upholstered seat
- Soft mesh or upholstered back
- Soft mesh consists of chenille, poly-filament blend
- Black polypropylene arm caps
- Aluminum uprights with welded steel frame
- Finishes include: powder-coated paint (black or silver) and chrome
- Black nylon glides
- Stacks up to 4-high

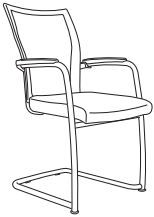

Shipping Weights (including packaging)

- Executive chair: 60 pounds/1 chair per carton/23.8 cubic feet
- Task chair: 52 pounds/1 chair per carton/19.7 cubic feet
- Guest chair with sled base: 35 pounds/1 chair per carton/19.5 cubic feet
- Seminar chair: 34 pounds/1 chair per carton/18.7 cubic feet
- Advanced Seminar chair: 40 pounds/1 chair per carton/16.0 cubic feet

General Guidelines for Product Specification

X99 specification numbers are based on an alpha-numeric logic that identifies a product by model and specific characteristics.

For instance, a product number that reads **X621-2Y41** identifies the product as an **X99** Task Chair, with 3-dimensional arms, mesh back and fabric upholstery seat, pneumatic height adjustment, and hard casters.

The numeric logic for this model with fabric and finish codes is shown below:

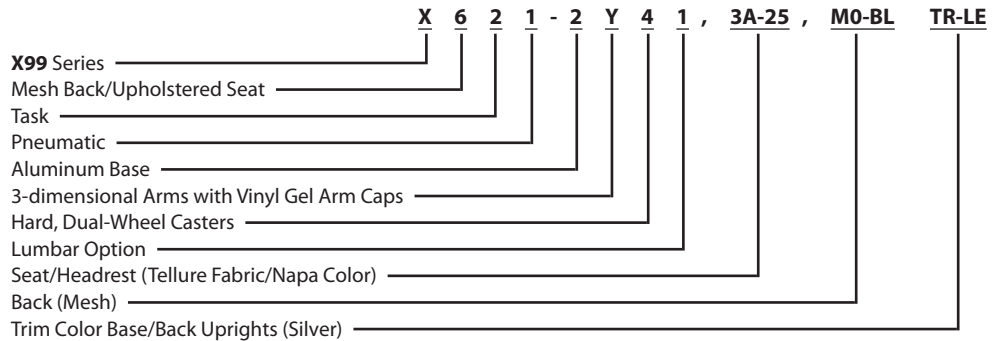

There are exceptions to this logic; therefore, always refer to the price charts for product numbers rather than attempting to construct them. Product number modification instructions for additional options appear in footnoted copy for each applicable model.

Beyond the printed product number, fabric and finish codes are required to complete an order specification. To communicate your order clearly, list the product number and finish codes in the sequence outlined on each price page.

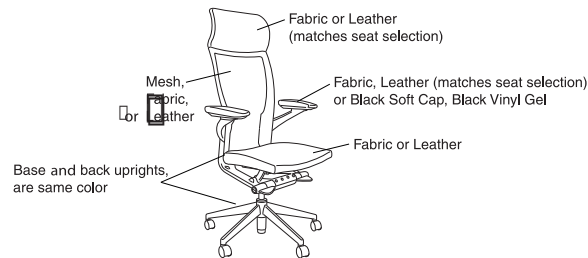

Note:

- Fully upholstered models require fabric/leather for seat and back to match. No dual fabrics or materials.
- Arms are black only.

COM & COL General Information

To order a COM fabric (Customer's Own Material), contact the Haworth Inquiry Center (1.800.426.8562), your local Haworth dealer, or go to haworth.com/surfaces > COM Library to find out if the COM you have selected has already been tested and approved. The surface collection site also has information on the Haworth+ alliance program with Carnegie, Luna Textiles, and Maharam as well as our industry-leading Pre-Approved COM program.

COM fabrics are placed into Grades based on the cost per linear yard. If a fabric's cost exceeds the range of our highest Grade it will be noted as Non-Graded. The product will be priced at Grade A; the COM fabric costs will appear as a separate line item. The fabric charge will be Haworth's purchase cost plus a 4% administrative fee (based on the cost of the fabric). Yardage calculations will include any applicable fabric repeat.

COM Leather products will be priced at a leather Grade A; COL costs will appear as a separate line item. The leather costs will be Haworth's purchase cost plus a 4% administrative fee (based on the cost of the leather).

X99

General Specifications

Finishes and Fabrics

A complete listing of finishes and fabrics for **X99** seating is available on pages 318 and 320-322.

Environmental FactorsMaterial Off Gassing

In an effort to ensure air quality standards, all **X99** parts suppliers are required to provide Material Data Sheets and/or other documentation, verifying their products do not emit volatile organic compounds (VOC). In addition, the powder-coat paint process used in the manufacturing of **X99** seating is free of VOCs. Our manufacturing processes have also eliminated all use of chlorofluorocarbons (CFCs) and ozone depleting chemicals (ODCs) in the chair's construction.

Recycling

All **X99** seating fabric scraps are recycled, reducing the amount of material sent to landfills, and all chair components disassemble easily to increase the potential for recycling. In addition, all thermo-plastic parts are 100% reprocessible, and all raw materials used in its manufacturing can be recycled at the end of the useful life of the product. Recyclable parts are identified with the recycle symbol where practical.

X99

Executive with 3-dimensional Arms

Deep Seat



X611-2W44

Dimensions*

- *SH: 16" - 20.5"
(406mm - 521mm)
- H: 47" - 51.5"
(1194mm - 1308mm)
- D: 25"(635mm)
- W: 26"(660mm)
- *SW: 18.6"(472mm)
- *AH: 6.3" - 10.8"
(160mm - 274mm)
- *SD: 17.5"(445mm)

Low-position pneumatic seat-height adjustment range:

15-18"(381mm-457mm)

Features

- Back: Soft mesh or upholstered.
- Seat: Standard upholstered.
- Base: Five-star aluminum base standard.
- Arm caps: Soft, upholstered or vinyl gel with pivoting and sliding capability.
- Casters: Standard with hard casters; for optional soft casters, see below.
- Mechanism: 3-point tilt.
- Height adjustment: Pneumatic or low position pneumatic; see below.
- Arm adjustment: 4"(102mm) height adjustment.
- Back stop: Single position.
- Free-floating forward tilt.
- Adjustable lumbar models available, with 1"(25mm) depth and 4"(102mm) height adjustment.
- COM yardage / COL square footage:
Mesh back model: 1.0/15
Fully upholstered model: 2.0/40

To Order, Specify:

- 1) Product number.
- 2) Fabric surface and color (seat/headrest/arm cap).
- 3) Fabric or mesh surface and color (back).
- 4) Trim color for base/back uprights. (Add **\$348.40** for chrome finish.)

* Measurements taken with the BIFMA chair measuring device.

Deep Seat	Back	Arm Caps	Number	Fabric Grade								Leather Grade A	Leather Grade B
				A	B	C	D	E	F	G	H		
Pneumatic Height													
Upholstered	Mesh	Soft	X611-2W44	\$2045.16	\$2085.50	\$2124.62	\$2145.39	\$2161.30	\$2246.87	\$2290.87	\$2410.67	\$2382.56	\$2543.45
		Upholstered	X611-2X44	2107.51	2147.85	2186.97	2207.74	2223.65	2309.22	2353.22	2473.02	2444.91	2605.80
		Vinyl Gel	X611-2Y44	2107.51	2147.85	2186.97	2207.74	2223.65	2309.22	2353.22	2473.02	2444.91	2605.80
Upholstered	Upholstered	Soft	X811-2W44	\$2122.17	\$2202.85	\$2281.09	\$2322.63	\$2354.45	\$2525.59	\$2613.59	\$2853.19	\$2796.97	\$3118.75
		Upholstered	X811-2X44	2184.52	2265.20	2343.44	2384.98	2416.80	2587.94	2675.94	2915.54	2859.32	3181.10
		Vinyl Gel	X811-2Y44	2184.52	2265.20	2343.44	2384.98	2416.80	2587.94	2675.94	2915.54	2859.32	3181.10
Pneumatic Height Adjustment with Lumbar													
Upholstered	Mesh	Soft	X611-2W45	\$2124.62	\$2164.96	\$2204.08	\$2224.85	\$2240.76	\$2326.33	\$2370.33	\$2490.13	\$2462.02	\$2622.91
		Upholstered	X611-2X45	2186.97	2227.31	2266.43	2287.20	2303.11	2388.68	2432.68	2552.48	2524.37	2685.26
		Vinyl Gel	X611-2Y45	2186.97	2227.31	2266.43	2287.20	2303.11	2388.68	2432.68	2552.48	2524.37	2685.26
Upholstered	Upholstered	Soft	X811-2W45	\$2201.63	\$2282.31	\$2360.55	\$2402.09	\$2433.91	\$2605.05	\$2693.05	\$2932.65	\$2876.43	\$3198.21
		Upholstered	X811-2X45	2263.98	2344.66	2422.90	2464.44	2496.26	2667.40	2755.40	2995.00	2938.78	3260.56
		Vinyl Gel	X811-2Y45	2263.98	2344.66	2422.90	2464.44	2496.26	2667.40	2755.40	2995.00	2938.78	3260.56

The following options require modification of the product number.

- Soft Caster
CAL 133
To specify, change the 7th digit from a 4 (hard caster) to a 2 (soft caster); **Example:** X611-2W24
- Low-position Pneumatic Option
To specify, add **-F** to end of the product number (add **\$118.58** list)
- Leather Seat and Mesh Back
To specify, change the 4th digit to 3 and 5th digit to 1; **Example:** X613-1W44
- Leather Seat and Leather Back
To specify, change the 2nd digit in mesh back model to 5; **Example:** X511-2W44
To specify, change the 2nd digit in upholstered back model to 7; **Example:** X711-2W44

NOTE: CAL 133 is available on mesh back models with upholstered arms caps only.

Low-position pneumatic option will have a steel base.

X99

Executive with 3-dimensional Arms

Standard Seat



X611-2W40

Dimensions*

- *SH: 16" - 20.5"
(406mm - 521mm)
- H: 47" - 51.5"
(1194mm - 1308mm)
- D: 25"(635mm)
- W: 26"(660mm)
- *SW: 18.6"(472mm)
- *AH: 6.3" - 10.8"
(160mm - 274mm)
- *SD: 16"(407mm)

Low-position pneumatic seat-height adjustment range:
15-18"(381mm-457mm)

Features

- Back: Soft mesh or upholstered.
- Seat: Standard upholstered.
- Base: Five-star aluminum base standard.
- Arm caps: Soft, upholstered or vinyl gel with pivoting and sliding capability.
- Casters: Standard with hard casters; for optional soft casters, see page 161.
- Mechanism: 3-point tilt.
- Height adjustment: Pneumatic or low position pneumatic; see page 161.
- Arm adjustment: 4"(102mm) height adjustment.
- Back stop: Single position.
- Free-floating forward tilt.
- Adjustable lumbar models available, with 1"(25mm) depth and 4"(102mm) height adjustment.
- 3-position seat-depth adjustment models are available with a 3 1/2"(89mm) range.
- COM yardage / COL square footage:
Mesh back model: 1.0/15
Fully upholstered model: 2.0/40

To Order, Specify:

- 1) Product number.
- 2) Fabric surface and color (seat/headrest/arm cap).
- 3) Fabric or mesh surface and color (back).
- 4) Trim color for base/back uprights. (Add **\$348.40** for chrome finish.)

* Measurements taken with the BIFMA chair measuring device.

Standard Seat	Back	Arm Caps	Number	Fabric Grade								Leather Grade A	Leather Grade B
				A	B	C	D	E	F	G	H		
Pneumatic Height Adjustment													
Upholstered	Mesh	Soft	X611-2W40	\$2045.16	\$2085.50	\$2124.62	\$2145.39	\$2161.30	\$2246.87	\$2290.87	\$2410.67	\$2382.56	\$2543.45
		Upholstered	X611-2X40	2107.51	2147.85	2186.97	2207.74	2223.65	2309.22	2353.22	2473.02	2444.91	2605.80
		Vinyl Gel	X611-2Y40	2107.51	2147.85	2186.97	2207.74	2223.65	2309.22	2353.22	2473.02	2444.91	2605.80
Upholstered	Upholstered	Soft	X811-2W40	\$2122.17	\$2202.85	\$2281.09	\$2322.63	\$2354.45	\$2525.59	\$2613.59	\$2853.19	\$2796.97	\$3118.75
		Upholstered	X811-2X40	2184.52	2265.20	2343.44	2384.98	2416.80	2587.94	2675.94	2915.54	2859.32	3181.10
		Vinyl Gel	X811-2Y40	2184.52	2265.20	2343.44	2384.98	2416.80	2587.94	2675.94	2915.54	2859.32	3181.10
Pneumatic Height Adjustment with Lumbar													
Upholstered	Mesh	Soft	X611-2W41	\$2124.62	\$2164.96	\$2204.08	\$2224.85	\$2240.76	\$2326.33	\$2370.33	\$2490.13	\$2462.02	\$2622.91
		Upholstered	X611-2X41	2186.97	2227.31	2266.43	2287.20	2303.11	2388.68	2432.68	2552.48	2524.37	2685.26
		Vinyl Gel	X611-2Y41	2186.97	2227.31	2266.43	2287.20	2303.11	2388.68	2432.68	2552.48	2524.37	2685.26
Upholstered	Upholstered	Soft	X811-2W41	\$2201.63	\$2282.31	\$2360.55	\$2402.09	\$2433.91	\$2605.05	\$2693.05	\$2932.65	\$2876.43	\$3198.21
		Upholstered	X811-2X41	2263.98	2344.66	2422.90	2464.44	2496.26	2667.40	2755.40	2995.00	2938.78	3260.56
		Vinyl Gel	X811-2Y41	2263.98	2344.66	2422.90	2464.44	2496.26	2667.40	2755.40	2995.00	2938.78	3260.56

The following options require modification of the product number.

- Leather Seat and Mesh Back To specify, change the 2nd digit in mesh back model to **5**; **Example:** X511-2W40
- Leather Seat and Leather Back To specify, change the 2nd digit in upholstered back model to **7**; **Example:** X711-2W40

X99

Executive with 3-dimensional Arms

Standard Seat

Standard Seat	Back	Arm Caps	Number	Fabric Grade								Leather Grade A	Leather Grade B
				A	B	C	D	E	F	G	H		
Pneumatic Height Adjustment with Seat Depth Adjustment													
Upholstered	Mesh	Soft	X611-2W42	\$2204.08	\$2244.42	\$2283.54	\$2304.31	\$2320.22	\$2405.79	\$2449.79	\$2569.59	\$2541.48	\$2702.37
		Upholstered	X611-2X42	2266.43	2306.77	2345.89	2366.66	2382.57	2468.14	2512.14	2631.94	2603.83	2764.72
		Vinyl Gel	X611-2Y42	2266.43	2306.77	2345.89	2366.66	2382.57	2468.14	2512.14	2631.94	2603.83	2764.72
Upholstered	Upholstered	Soft	X811-2W42	\$2281.09	\$2361.77	\$2440.01	\$2481.55	\$2513.37	\$2684.51	\$2772.51	\$3012.11	\$2955.89	\$3277.67
		Upholstered	X811-2X42	2343.44	2424.12	2502.36	2543.90	2575.72	2746.86	2834.86	3074.46	3018.24	3340.02
		Vinyl Gel	X811-2Y42	2343.44	2424.12	2502.36	2543.90	2575.72	2746.86	2834.86	3074.46	3018.24	3340.02
Pneumatic Height Adjustment with Lumbar and Seat Depth Adjustment													
Upholstered	Mesh	Soft	X611-2W43	\$2283.54	\$2323.88	\$2363.00	\$2383.77	\$2399.68	\$2485.25	\$2529.25	\$2649.05	\$2620.94	\$2781.83
		Upholstered	X611-2X43	2345.89	2386.23	2425.35	2446.12	2462.03	2547.60	2591.60	2711.40	2683.29	2844.18
		Vinyl Gel	X611-2Y43	2345.89	2386.23	2425.35	2446.12	2462.03	2547.60	2591.60	2711.40	2683.29	2844.18
Upholstered	Upholstered	Soft	X811-2W43	\$2360.55	\$2441.23	\$2519.47	\$2561.01	\$2592.83	\$2763.97	\$2851.97	\$3091.57	\$3035.35	\$3357.13
		Upholstered	X811-2X43	2422.90	2503.58	2581.82	2623.36	2655.18	2826.32	2914.32	3153.92	3097.70	3419.48
		Vinyl Gel	X811-2Y43	2422.90	2503.58	2581.82	2623.36	2655.18	2826.32	2914.32	3153.92	3097.70	3419.48

The following options require modification of the product number.

Soft Caster

To specify, change the 7th digit from a 4 (hard caster) to a 2 (soft caster); **Example:** X611-2W20

CAL 133

To specify, add -F to end of the product number (add \$118.58 list)

Low-position Pneumatic Option

To specify, change the 4th digit to 3 and 5th digit to 1; **Example:** X613-1W40

NOTE: Low-position pneumatic option will have a steel base.

X99

Executive with Loop Arms

Deep Seat



X611-2144

Dimensions*

- *SH: 16" - 20.5"
(406mm - 521mm)
- H: 47" - 51.5"
(1194mm - 1308mm)
- D: 25"(635mm)
- W: 26"(660mm)
- *SW: 18.6"(472mm)
- *AH: 7.3"(185mm)
- *SD: 17.5"(445mm)

Low-position pneumatic seat-height adjustment range: 15-18"(381mm-457mm)

Features

- Back: Soft mesh or upholstered.
- Seat: Standard upholstered.
- Base: Five-star aluminum base standard.
- Arms: Fixed loop with black polypropylene arm caps.
- Casters: Standard with hard casters; for optional soft casters, see below.
- Mechanism: 3-point tilt.
- Height adjustment: Pneumatic or low-position pneumatic; see below.
- Back stop: Single position.
- Free-floating forward tilt.
- Adjustable lumbar models available, with 1"(25mm) depth and 4"(102mm) height adjustment.
- COM yardage / COL square footage:
Mesh back model: 1.0/15
Fully upholstered model: 2.0/40

To Order, Specify:

- 1) Product number.
- 2) Fabric surface and color (seat/headrest/arm cap).
- 3) Fabric or mesh surface and color (back).
- 4) Trim color for base/back uprights. (Add **\$348.40** for chrome finish.)

* Measurements taken with the BIFMA chair measuring device.

Deep Seat	Back	Arm Caps	Number	Fabric Grade		C	D	E	F	G	H	Leather Grade A	Leather Grade B
				A	B								
Pneumatic Height													
Upholstered	Mesh	Standard	X611-2144	\$1887.46	\$1927.80	\$1966.92	\$1987.69	\$2003.60	\$2089.17	\$2133.17	\$2252.97	\$2224.86	\$2385.75
Upholstered	Upholstered	Standard	X811-2144	1964.47	2045.15	2123.39	2164.93	2196.75	2367.89	2455.89	2695.49	2639.27	2961.05
Pneumatic Height Adjustment with Lumbar													
Upholstered	Mesh	Standard	X611-2145	\$1966.92	\$2007.26	\$2046.38	\$2067.15	\$2083.06	\$2168.63	\$2212.63	\$2332.43	\$2304.32	\$2465.21
Upholstered	Upholstered	Standard	X811-2145	2043.93	2124.61	2202.85	2244.39	2276.21	2447.35	2535.35	2774.95	2718.73	3040.51

The following options require modification of the product number.

- Soft Caster To specify, change the 7th digit from a 4 (hard caster) to a 2 (soft caster); **Example:** X611-2124
- Low-position Pneumatic Option To specify, change the 4th digit to 3 and 5th digit to 1; **Example:** X613-1144
- Leather Seat and Mesh Back To specify, change the 2nd digit in mesh back model to 5; **Example:** X511-2144
- Leather Seat and Leather Back To specify, change the 2nd digit in upholstered back model to 7; **Example:** X711-2144

NOTE: Low-position pneumatic option will have a steel base.

X99

Executive with Loop Arms

Standard Seat



X611-2140

Dimensions*

*SH: 16" - 20.5"
(406mm - 521mm)
H: 47" - 51.5"
(1194mm - 1308mm)
D: 25"(635mm)
W: 26"(660mm)
*SW: 18.6"(472mm)
*AH: 7.3"(185mm)
*SD: 16"(407mm)

Low-position pneumatic
seat-height adjustment
range:
15-18"(381mm-457mm)

Features

- Back: Soft mesh or upholstered.
- Seat: Standard upholstered.
- Base: Five-star aluminum base standard.
- Arms: Fixed loop with black polypropylene arm caps.
- Casters: Standard with hard casters; for optional soft casters, see below.
- Mechanism: 3-point tilt.
- Height adjustment: Pneumatic or low-position pneumatic; see below.
- Back stop: Single position.
- Free-floating forward tilt.
- Adjustable lumbar models available, with 1"(25mm) depth and 4"(102mm) height adjustment.
- 3-position seat-depth adjustment models are available with a 3 1/2"(89mm) range.
- COM yardage / COL square footage:
Mesh back model: 1.0/15
Fully upholstered model: 2.0/40

To Order, Specify:

- 1) Product number.
- 2) Fabric surface and color (seat/headrest/arm cap).
- 3) Fabric or mesh surface and color (back).
- 4) Trim color for base/back uprights. (Add **\$348.40** for chrome finish.)

* Measurements taken with the BIFMA chair measuring device.

Standard Seat	Back	Arm Caps	Number	Fabric Grade								Leather Grade A	Leather Grade B
				A	B	C	D	E	F	G	H		
Pneumatic Height Adjustment													
Upholstered	Mesh	Standard	X611-2140	\$1887.46	\$1927.80	\$1966.92	\$1987.69	\$2003.60	\$2089.17	\$2133.17	\$2252.97	\$2224.86	\$2385.75
Upholstered	Upholstered	Standard	X811-2140	1964.47	2045.15	2123.39	2164.93	2196.75	2367.89	2455.89	2695.49	2639.27	2961.05
Pneumatic Height Adjustment with Lumbar													
Upholstered	Mesh	Standard	X611-2141	\$1966.92	\$2007.26	\$2046.38	\$2067.15	\$2083.06	\$2168.63	\$2212.63	\$2332.43	\$2304.32	\$2465.21
Upholstered	Upholstered	Standard	X811-2141	2043.93	2124.61	2202.85	2244.39	2276.21	2447.35	2535.35	2774.95	2718.73	3040.51
Pneumatic Height Adjustment with Seat Depth Adjustment													
Upholstered	Mesh	Standard	X611-2142	\$2046.38	\$2086.72	\$2125.84	\$2146.61	\$2162.52	\$2248.09	\$2292.09	\$2411.89	\$2383.78	\$2544.67
Upholstered	Upholstered	Standard	X811-2142	2123.39	2204.07	2282.31	2323.85	2355.67	2526.81	2614.81	2854.41	2798.19	3119.97
Pneumatic Height Adjustment with Lumbar and Seat Depth Adjustment													
Upholstered	Mesh	Standard	X611-2143	\$2125.84	\$2166.18	\$2205.30	\$2226.07	\$2241.98	\$2327.55	\$2371.55	\$2491.35	\$2463.24	\$2624.13
Upholstered	Upholstered	Standard	X811-2143	2202.85	2283.53	2361.77	2403.31	2435.13	2606.27	2694.27	2933.87	2877.65	3199.43

The following options require modification of the product number.

Soft Caster	To specify, change the 7th digit from a 4 (hard caster) to a 2 (soft caster); Example: X611-2120
Low-position Pneumatic Option	To specify, change the 4th digit to 3 and 5th digit to 1; Example: X613-1140
Leather Seat and Mesh Back	To specify, change the 2nd digit in mesh back model to 5; Example: X511-2140
Leather Seat and Leather Back	To specify, change the 2nd digit in upholstered back model to 7; Example: X711-2140

NOTE: Low-position pneumatic option will have a steel base.

X99

Executive without Arms

Deep Seat



X611-2044

Dimensions*

- *SH: 16" - 20.5"
(406mm - 521mm)
- H: 47" - 51.5"
(1194mm - 1308mm)
- D: 25"(635mm)
- W: 26"(660mm)
- *SW: 18.6"(472mm)
- *SD: 17.5"(445mm)

Low-position pneumatic seat-height adjustment range:
15-18"(381mm-457mm)

Features

- Back: Soft mesh or upholstered.
- Seat: Standard upholstered.
- Base: Five-star aluminum base standard.
- Casters: Standard with hard casters; for optional soft casters, see below.
- Mechanism: 3-point tilt.
- Height adjustment: Pneumatic or low-position pneumatic; see below.
- Back stop: Single position.
- Free-floating forward tilt.
- Adjustable lumbar models available, with 1"(25mm) depth and 4"(102mm) height adjustment.
- COM yardage / COL square footage:
Mesh back model: 1.0/15
Fully upholstered model: 2.0/40

To Order, Specify:

- 1) Product number.
- 2) Fabric surface and color (seat/headrest).
- 3) Fabric or mesh surface and color (back).
- 4) Trim color for base/back uprights. (Add **\$348.40** for chrome finish.)

* Measurements taken with the BIFMA chair measuring device.

Deep Seat	Back	Number	Fabric Grade		C	D	E	F	G	H	Leather Grade A	Leather Grade B
			A	B								
Pneumatic Height												
Upholstered	Mesh	X611-2044	\$1727.32	\$1767.66	\$1806.78	\$1827.55	\$1843.46	\$1929.03	\$1973.03	\$2092.83	\$2064.72	\$2225.61
Upholstered	Upholstered	X811-2044	1804.33	1885.01	1963.25	2004.79	2036.61	2207.75	2295.75	2535.35	2479.13	2800.91
Pneumatic Height Adjustment with Lumbar												
Upholstered	Mesh	X611-2045	\$1806.78	\$1847.12	\$1886.24	\$1907.01	\$1922.92	\$2008.49	\$2052.49	\$2172.29	\$2144.18	\$2305.07
Upholstered	Upholstered	X811-2045	1883.79	1964.47	2042.71	2084.25	2116.07	2287.21	2375.21	2614.81	2558.59	2880.37

The following options require modification of the product number.

- Soft Caster To specify, change the 7th digit from a **4** (hard caster) to a **2** (soft caster); **Example:** X611-2024
- CAL 133 To specify, add **-F** to end of the product number (add **\$118.58** list)
- Low-position Pneumatic Option To specify, change the 4th digit to **3** and 5th digit to **1**; **Example:** X613-1044
- Leather Seat and Mesh Back To specify, change the 2nd digit in mesh back model to **5**; **Example:** X511-2044
- Leather Seat and Leather Back To specify, change the 2nd digit in upholstered back model to **7**; **Example:** X711-2044

NOTE: Low-position pneumatic option will have a steel base.

X99

Executive without Arms

Standard Seat



X611-2040

Dimensions*

- *SH: 16" - 20.5"
(406mm - 521mm)
- H: 47" - 51.5"
(1194mm - 1308mm)
- D: 25"(635mm)
- W: 26"(660mm)
- *SW: 18.6"(472mm)
- *SD: 16"(407mm)

Low-position pneumatic seat-height adjustment range:
15-18"(381mm-457mm)

Features

- Back: Soft mesh or upholstered.
- Seat: Standard upholstered.
- Base: Five-star aluminum base standard.
- Casters: Standard with hard casters; for optional soft casters, see below.
- Mechanism: 3-point tilt.
- Height adjustment: Pneumatic or low-position pneumatic; see below.
- Back stop: Single position.
- Free-floating forward tilt.
- Adjustable lumbar models available, with 1"(25mm) depth and 4"(102mm) height adjustment.
- 3-position seat-depth adjustment models are available with a 3 1/2"(89mm) range.
- COM yardage / COL square footage:
Mesh back model: 1.0/15
Fully upholstered model: 2.0/40

To Order, Specify:

- 1) Product number.
- 2) Fabric surface and color (seat/headrest).
- 3) Fabric or mesh surface and color (back).
- 4) Trim color for base/back uprights. (Add **\$348.40** for chrome finish.)

* Measurements taken with the BIFMA chair measuring device.

Standard Seat	Back	Number	Fabric Grade		C	D	E	F	G	H	Leather Grade A	Leather Grade B
			A	B								
Pneumatic Height Adjustment												
Upholstered	Mesh	X611-2040	\$1727.32	\$1767.66	\$1806.78	\$1827.55	\$1843.46	\$1929.03	\$1973.03	\$2092.83	\$2064.72	\$2225.61
Upholstered	Upholstered	X811-2040	1804.33	1885.01	1963.25	2004.79	2036.61	2207.75	2295.75	2535.35	2479.13	2800.91
Pneumatic Height Adjustment with Lumbar												
Upholstered	Mesh	X611-2041	\$1806.78	\$1847.12	\$1886.24	\$1907.01	\$1922.92	\$2008.49	\$2052.49	\$2172.29	\$2144.18	\$2305.07
Upholstered	Upholstered	X811-2041	1883.79	1964.47	2042.71	2084.25	2116.07	2287.21	2375.21	2614.81	2558.59	2880.37
Pneumatic Height Adjustment with Seat Depth Adjustment												
Upholstered	Mesh	X611-2042	\$1886.24	\$1926.58	\$1965.70	\$1986.47	\$2002.38	\$2087.95	\$2131.95	\$2251.75	\$2223.64	\$2384.53
Upholstered	Upholstered	X811-2042	1963.25	2043.93	2122.17	2163.71	2195.53	2366.67	2454.67	2694.27	2638.05	2959.83
Pneumatic Height Adjustment with Lumbar and Seat Depth Adjustment												
Upholstered	Mesh	X611-2043	\$1965.70	\$2006.04	\$2045.16	\$2065.93	\$2081.84	\$2167.41	\$2211.41	\$2331.21	\$2303.10	\$2463.99
Upholstered	Upholstered	X811-2043	2042.71	2123.39	2201.63	2243.17	2274.99	2446.13	2534.13	2773.73	2717.51	3039.29

The following options require modification of the product number.

- Soft Caster
CAL 133
To specify, change the 7th digit from a 4 (hard caster) to a 2 (soft caster); **Example:** X611-2020
- Low-position Pneumatic Option
To specify, add -F to end of the product number (add **\$118.58** list)
- Leather Seat and Mesh Back
To specify, change the 4th digit to 3 and 5th digit to 1; **Example:** X613-1040
- Leather Seat and Leather Back
To specify, change the 2nd digit in mesh back model to 5; **Example:** X511-2040
To specify, change the 2nd digit in upholstered back model to 7; **Example:** X711-2040

NOTE: CAL 133 is available on mesh back models only.

Low-position pneumatic option will have a steel base.

This page intentionally blank

X99

Task Chair with 3-dimensional Arms

Deep Seat



X621-2W44

Dimensions*

- *SH: 16" - 20.5"
(406mm - 521mm)
- H: 38.5" - 43"
(978mm - 1092mm)
- D: 25"(635mm)
- W: 26"(660mm)
- *SW: 18.6"(472mm)
- *AH: 6.3" - 10.8"
(160mm - 274mm)
- *SD: 17.5"(445mm)

Low-position pneumatic seat-height adjustment range:

15-18"(381mm-457mm)

Features

- Back: Soft mesh or upholstered.
- Seat: Standard upholstered.
- Base: Five-star aluminum base standard.
- Arm caps: Soft, upholstered or vinyl gel with pivoting and sliding capability.
- Casters: Standard with hard casters; for optional soft casters, see below.
- Mechanism: 3-point tilt.
- Height adjustment: Pneumatic or low-position pneumatic; see below.
- Arm adjustment: 4"(102mm) height adjustment.
- Back stop: Single position.
- Free-floating forward tilt.
- Adjustable lumbar models available, with 1"(25mm) depth and 4"(102mm) height adjustment.
- COM yardage / COL square footage:
Mesh back model: 0.75/15
Fully upholstered model: 1.75/25

To Order, Specify:

- 1) Product number.
- 2) Fabric surface and color (seat/arm cap).
- 3) Fabric or mesh surface and color (back).
- 4) Trim color for base/back uprights. (Add **\$348.40** for chrome finish.)

* Measurements taken with the BIFMA chair measuring device.

Deep Seat	Back	Arm Caps	Number	Fabric Grade								Leather Grade A	Leather Grade B
				A	B	C	D	E	F	G	H		
Pneumatic Height													
Upholstered	Mesh	Soft	X621-2W44	\$1883.80	\$1924.14	\$1963.26	\$1984.03	\$1999.94	\$2035.39	\$2068.39	\$2158.85	\$2221.20	\$2382.09
		Upholstered	X621-2X44	1946.15	1986.49	2025.61	2046.38	2062.29	2097.74	2130.74	2221.20	2283.55	2444.44
		Vinyl Gel	X621-2Y44	1946.15	1986.49	2025.61	2046.38	2062.29	2097.74	2130.74	2221.20	2283.55	2444.44
Upholstered	Upholstered	Soft	X821-2W44	\$1963.26	\$2043.94	\$2122.18	\$2163.72	\$2195.54	\$2266.44	\$2332.44	\$2513.36	\$2638.06	\$2959.84
		Upholstered	X821-2X44	2025.61	2106.29	2184.53	2226.07	2257.89	2328.79	2394.79	2575.71	2700.41	3022.19
		Vinyl Gel	X821-2Y44	2025.61	2106.29	2184.53	2226.07	2257.89	2328.79	2394.79	2575.71	2700.41	3022.19
Pneumatic Height Adjustment with Lumbar													
Upholstered	Mesh	Soft	X621-2W45	\$1963.26	\$2003.60	\$2042.72	\$2063.49	\$2079.40	\$2114.85	\$2147.85	\$2238.31	\$2300.66	\$2461.55
		Upholstered	X621-2X45	2025.61	2065.95	2105.07	2125.84	2141.75	2177.20	2210.20	2300.66	2363.01	2523.90
		Vinyl Gel	X621-2Y45	2025.61	2065.95	2105.07	2125.84	2141.75	2177.20	2210.20	2300.66	2363.01	2523.90
Upholstered	Upholstered	Soft	X821-2W45	\$2042.72	\$2123.40	\$2201.64	\$2243.18	\$2275.00	\$2345.90	\$2411.90	\$2592.82	\$2717.52	\$3039.30
		Upholstered	X821-2X45	2105.07	2185.75	2263.99	2305.53	2337.35	2408.25	2474.25	2655.17	2779.87	3101.65
		Vinyl Gel	X821-2Y45	2105.07	2185.75	2263.99	2305.53	2337.35	2408.25	2474.25	2655.17	2779.87	3101.65

The following options require modification of the product number.

- Soft Caster
CAL 133
Stain repellent
Low-position Pneumatic Option
Leather Seat and Mesh Back
Leather Seat and Leather Back
- To specify, change the 7th digit from a 4 (hard caster) to a 2 (soft caster); **Example:** X621-2W24
- To specify, add **-F** to end of the product number (add **\$118.58** list)
- To specify, add **-P** to end of the product number; **Example:** X621-2W44-P (add **\$39.11** list)
- To specify, change the 4th digit to **3** and 5th digit to **1**; **Example:** X623-1W44
- To specify, change the 2nd digit in mesh back model to **5**; **Example:** X521-2W44
- To specify, change the 2nd digit in upholstered back model to **7**; **Example:** X721-2W44

NOTE: CAL 133 is available on mesh back models with upholstered arms caps only.

Low-position pneumatic option will have a steel base.

For available fabrics, refer to surfaces.haworth.com.

X99

Task Chair with 3-dimensional Arms

Standard Seat



X621-2W40

Dimensions*

- *SH: 16" - 20.5"
(406mm - 521mm)
- H: 38.5" - 43"
(978mm - 1092mm)
- D: 25"(635mm)
- W: 26"(660mm)
- *SW: 18.6"(472mm)
- *AH: 6.3" - 10.8"
(160mm - 274mm)
- *SD: 16"(407mm)

Low-position pneumatic seat-height adjustment range:
15-18"(381mm-457mm)

Features

- Back: Soft mesh or upholstered.
- Seat: Standard upholstered.
- Base: Five-star aluminum base standard.
- Arm caps: Soft, upholstered or vinyl gel with pivoting and sliding capability.
- Casters: Standard with hard casters; for optional soft casters, see page 169.
- Mechanism: 3-point tilt.
- Height adjustment: Pneumatic or low-position pneumatic; see page 169.
- Arm adjustment: 4"(102mm) height adjustment.
- Back stop: Single position.
- Free-floating forward tilt.
- Adjustable lumbar models available, with 1"(25mm) depth and 4"(102mm) height adjustment.
- 3-position seat-depth adjustment models are available with a 3 1/2"(89mm) range.
- COM yardage / COL square footage:
Mesh back model: 0.75/15
Fully upholstered model: 1.75/25

To Order, Specify:

- 1) Product number.
- 2) Fabric surface and color (seat/arm cap).
- 3) Fabric or mesh surface and color (back).
- 4) Trim color for base/back uprights. (Add **\$348.40** for chrome finish.)

* Measurements taken with the BIFMA chair measuring device.

Standard Seat	Back	Arm Caps	Number	Fabric Grade								Leather Grade A	Leather Grade B
				A	B	C	D	E	F	G	H		
Pneumatic Height Adjustment													
Upholstered	Mesh	Soft	X621-2W40	\$1883.80	\$1924.14	\$1963.26	\$1984.03	\$1999.94	\$2035.39	\$2068.39	\$2158.85	\$2221.20	\$2382.09
		Upholstered	X621-2X40	1946.15	1986.49	2025.61	2046.38	2062.29	2097.74	2130.74	2221.20	2283.55	2444.44
		Vinyl Gel	X621-2Y40	1946.15	1986.49	2025.61	2046.38	2062.29	2097.74	2130.74	2221.20	2283.55	2444.44
Upholstered	Upholstered	Soft	X821-2W40	\$1963.26	\$2043.94	\$2122.18	\$2163.72	\$2195.54	\$2266.44	\$2332.44	\$2513.36	\$2638.06	\$2959.84
		Upholstered	X821-2X40	2025.61	2106.29	2184.53	2226.07	2257.89	2328.79	2394.79	2575.71	2700.41	3022.19
		Vinyl Gel	X821-2Y40	2025.61	2106.29	2184.53	2226.07	2257.89	2328.79	2394.79	2575.71	2700.41	3022.19
Pneumatic Height Adjustment with Lumbar													
Upholstered	Mesh	Soft	X621-2W41	\$1963.26	\$2003.60	\$2042.72	\$2063.49	\$2079.40	\$2114.85	\$2147.85	\$2238.31	\$2300.66	\$2461.55
		Upholstered	X621-2X41	2025.61	2065.95	2105.07	2125.84	2141.75	2177.20	2210.20	2300.66	2363.01	2523.90
		Vinyl Gel	X621-2Y41	2025.61	2065.95	2105.07	2125.84	2141.75	2177.20	2210.20	2300.66	2363.01	2523.90
Upholstered	Upholstered	Soft	X821-2W41	\$2042.72	\$2123.40	\$2201.64	\$2243.18	\$2275.00	\$2345.90	\$2411.90	\$2592.82	\$2717.52	\$3039.30
		Upholstered	X821-2X41	2105.07	2185.75	2263.99	2305.53	2337.35	2408.25	2474.25	2655.17	2779.87	3101.65
		Vinyl Gel	X821-2Y41	2105.07	2185.75	2263.99	2305.53	2337.35	2408.25	2474.25	2655.17	2779.87	3101.65

The following options require modification of the product number.

- Leather Seat and Mesh Back To specify, change the 2nd digit in mesh back model to **5**; **Example:** X521-2W40
- Leather Seat and Leather Back To specify, change the 2nd digit in upholstered back model to **7**; **Example:** X721-2W40

X99

Task Chair with 3-dimensional Arms

Standard Seat

Seat	Back	Arm Caps	Number	Fabric Grade								Leather Grade A	Leather Grade B
				A	B	C	D	E	F	G	H		
Pneumatic Height Adjustment with Seat Depth Adjustment													
Upholstered	Mesh	Soft	X621-2W42	\$2043.94	\$2084.28	\$2123.40	\$2144.17	\$2160.08	\$2195.53	\$2228.53	\$2318.99	\$2381.34	\$2542.23
		Upholstered	X621-2X42	2106.29	2146.63	2185.75	2206.52	2222.43	2257.88	2290.88	2381.34	2443.69	2604.58
		Vinyl Gel	X621-2Y42	2106.29	2146.63	2185.75	2206.52	2222.43	2257.88	2290.88	2381.34	2443.69	2604.58
Upholstered	Upholstered	Soft	X821-2W42	\$2123.40	\$2204.08	\$2282.32	\$2323.86	\$2355.68	\$2426.58	\$2492.58	\$2673.50	\$2798.20	\$3119.98
		Upholstered	X821-2X42	2185.75	2266.43	2344.67	2386.21	2418.03	2488.93	2554.93	2735.85	2860.55	3182.33
		Vinyl Gel	X821-2Y42	2185.75	2266.43	2344.67	2386.21	2418.03	2488.93	2554.93	2735.85	2860.55	3182.33
Pneumatic Height Adjustment with Lumbar and Seat Depth Adjustment													
Upholstered	Mesh	Soft	X621-2W43	\$2123.40	\$2163.74	\$2202.86	\$2223.63	\$2239.54	\$2274.99	\$2307.99	\$2398.45	\$2460.80	\$2621.69
		Upholstered	X621-2X43	2185.75	2226.09	2265.21	2285.98	2301.89	2337.34	2370.34	2460.80	2523.15	2684.04
		Vinyl Gel	X621-2Y43	2185.75	2226.09	2265.21	2285.98	2301.89	2337.34	2370.34	2460.80	2523.15	2684.04
Upholstered	Upholstered	Soft	X821-2W43	\$2202.86	\$2283.54	\$2361.78	\$2403.32	\$2435.14	\$2506.04	\$2572.04	\$2752.96	\$2877.66	\$3199.44
		Upholstered	X821-2X43	2265.21	2345.89	2424.13	2465.67	2497.49	2568.39	2634.39	2815.31	2940.01	3261.79
		Vinyl Gel	X821-2Y43	2265.21	2345.89	2424.13	2465.67	2497.49	2568.39	2634.39	2815.31	2940.01	3261.79

The following options require modification of the product number.

Soft Caster

To specify, change the 7th digit from a 4 (hard caster) to a 2 (soft caster); **Example:** X621-2W20

CAL 133

To specify, add -F to end of the product number (add \$118.58 list)

Stain repellent

To specify, add -P to end of the product number; **Example:** X621-2W40-P (add \$39.11 list)

Low-position Pneumatic Option

To specify, change the 4th digit to 3 and 5th digit to 1; **Example:** X623-1W40

NOTE: CAL 133 is available on mesh back models with upholstered arms caps only.

Low-position pneumatic option will have a steel base.

For available fabrics, refer to surfaces.haworth.com.

X99

Task Chair with Loop Arms

Deep Seat



X621-2144

Dimensions*

- *SH: 16" - 20.5"
(406mm - 521mm)
- H: 38.5" - 43"
(978mm-1092mm)
- D: 25"(635mm)
- W: 26"(660mm)
- *SW: 18.6"(472mm)
- *AH: 7.3"(185mm)
- *SD: 17.5"(445mm)

Low-position pneumatic seat-height adjustment range:

15-18"(381mm-457mm)

Features

- Back: Soft mesh or upholstered.
- Seat: Standard upholstered.
- Base: Five-star aluminum base standard.
- Arms: Fixed loop with black polypropylene arm caps.
- Casters: Standard with hard casters; for optional soft casters, see below.
- Mechanism: 3-point tilt.
- Height adjustment: Pneumatic or low-position pneumatic; see below.
- Back stop: Single position.
- Free-floating forward tilt.
- Adjustable lumbar models available, with 1"(25mm) depth and 4"(102mm) height adjustment.
- COM yardage / COL square footage:
Mesh back model: 0.75/15
Fully upholstered model: 1.75/25

To Order, Specify:

- 1) Product number.
- 2) Fabric surface and color (seat/arm cap).
- 3) Fabric or mesh surface and color (back).
- 4) Trim color for base/back uprights. (Add **\$348.40** for chrome finish.)

* Measurements taken with the BIFMA chair measuring device.

Deep Seat	Back	Arm Caps	Number	Fabric Grade		C	D	E	F	G	H	Leather Grade A	Leather Grade B
				A	B								
Pneumatic Height													
Upholstered	Mesh	Standard	X621-2144	\$1727.32	\$1767.66	\$1806.78	\$1827.55	\$1843.46	\$1878.91	\$1911.91	\$2002.37	\$2064.72	\$2225.61
Upholstered	Upholstered	Standard	X821-2144	1806.78	1887.46	1965.70	2007.24	2039.06	2109.96	2175.96	2356.88	2481.58	2803.36
Pneumatic Height Adjustment with Lumbar													
Upholstered	Mesh	Standard	X621-2145	\$1806.78	\$1847.12	\$1886.24	\$1907.01	\$1922.92	\$1958.37	\$1991.37	\$2081.83	\$2144.18	\$2305.07
Upholstered	Upholstered	Standard	X821-2145	1886.24	1966.92	2045.16	2086.70	2118.52	2189.42	2255.42	2436.34	2561.04	2882.82

The following options require modification of the product number.

- Soft Caster To specify, change the 7th digit from a 4 (hard caster) to a 2 (soft caster); **Example:** X621-2124
- Stain repellent To specify, add **-P** to end of the product number; **Example:** X621-2144-**P** (add **\$39.11** list)
- Low-position Pneumatic Option To specify, change the 4th digit to **3** and 5th digit to **1**; **Example:** X623-1144
- Leather Seat and Mesh Back To specify, change the 2nd digit in mesh back model to **5**; **Example:** X521-2144
- Leather Seat and Leather Back To specify, change the 2nd digit in upholstered back model to **7**; **Example:** X721-2144

NOTE: Low-position pneumatic option will have a steel base.

For available fabrics, refer to surfaces.haworth.com.

X99

Task Chair with Loop Arms

Standard Seat



X621-2140

Dimensions*

- *SH: 16" - 20.5"
(406mm - 521mm)
- H: 38.5" - 43"
(978mm-1092mm)
- D: 25"(635mm)
- W: 26"(660mm)
- *SW: 18.6"(472mm)
- *AH: 7.3"(185mm)
- *SD: 16"(407mm)

Low-position pneumatic seat-height adjustment range:
15-18"(381mm-457mm)

Features

- Back: Soft mesh or upholstered.
- Seat: Standard upholstered.
- Base: Five-star aluminum base standard.
- Arms: Fixed loop with black polypropylene arm caps.
- Casters: Standard with hard casters; for optional soft casters, see below.
- Mechanism: 3-point tilt.
- Height adjustment: Pneumatic or low-position pneumatic; see below.
- Back stop: Single position.
- Free-floating forward tilt.
- Adjustable lumbar models available, with 1"(25mm) depth and 4"(102mm) height adjustment.
- 3-position seat-depth adjustable models are available with a 3 1/2"(89mm) range.
- COM yardage / COL square footage:
Mesh back model: 0.75/15
Fully upholstered model: 1.75/25

To Order, Specify:

- 1) Product number.
- 2) Fabric surface and color (seat/arm cap).
- 3) Fabric or mesh surface and color (back).
- 4) Trim color for base/back uprights. (Add **\$348.40** for chrome finish.)

* Measurements taken with the BIFMA chair measuring device.

Standard Seat	Back	Arm Caps	Number	Fabric Grade								Leather Grade A	Leather Grade B
				A	B	C	D	E	F	G	H		
Pneumatic Height Adjustment													
Upholstered	Mesh	Standard	X621-2140	\$1727.32	\$1767.66	\$1806.78	\$1827.55	\$1843.46	\$1878.91	\$1911.91	\$2002.37	\$2064.72	\$2225.61
Upholstered	Upholstered	Standard	X821-2140	1806.78	1887.46	1965.70	2007.24	2039.06	2109.96	2175.96	2356.88	2481.58	2803.36
Pneumatic Height Adjustment with Lumbar													
Upholstered	Mesh	Standard	X621-2141	\$1806.78	\$1847.12	\$1886.24	\$1907.01	\$1922.92	\$1958.37	\$1991.37	\$2081.83	\$2144.18	\$2305.07
Upholstered	Upholstered	Standard	X821-2141	1886.24	1966.92	2045.16	2086.70	2118.52	2189.42	2255.42	2436.34	2561.04	2882.82
Pneumatic Height Adjustment with Seat Depth Adjustment													
Upholstered	Mesh	Standard	X621-2142	\$1887.46	\$1927.80	\$1966.92	\$1987.69	\$2003.60	\$2039.05	\$2072.05	\$2162.51	\$2224.86	\$2385.75
Upholstered	Upholstered	Standard	X821-2142	1966.92	2047.60	2125.84	2167.38	2199.20	2270.10	2336.10	2517.02	2641.72	2963.50
Pneumatic Height Adjustment with Lumbar and Seat Depth Adjustment													
Upholstered	Mesh	Standard	X621-2143	\$1966.92	\$2007.26	\$2046.38	\$2067.15	\$2083.06	\$2118.51	\$2151.51	\$2241.97	\$2304.32	\$2465.21
Upholstered	Upholstered	Standard	X821-2143	2046.38	2127.06	2205.30	2246.84	2278.66	2349.56	2415.56	2596.48	2721.18	3042.96

The following options require modification of the product number.

- Soft Caster To specify, change the 7th digit from a 4 (hard caster) to a 2 (soft caster); **Example:** X621-2120
- Stain repellent To specify, add -P to end of the product number; **Example:** X621-2140-P (add \$39.11 list)
- Low-position Pneumatic Option To specify, change the 4th digit to 3 and 5th digit to 1; **Example:** X623-1140
- Leather Seat and Mesh Back To specify, change the 2nd digit in mesh back model to 5; **Example:** X521-2140
- Leather Seat and Leather Back To specify, change the 2nd digit in upholstered back model to 7; **Example:** X721-2140

NOTE: Low-position pneumatic option will have a steel base.

For available fabrics, refer to surfaces.haworth.com.

X99

Task Chair without Arms

Deep Seat



X621-2044

Dimensions*

- *SH: 16" - 20.5"
(406mm - 521mm)
- H: 38.5" - 43"
(978mm-1092mm)
- D: 25"(635mm)
- W: 26"(660mm)
- *SW: 18.6"(472mm)
- *SD: 17.5"(445mm)

Low-position pneumatic seat-height adjustment range:
15-18"(381mm-457mm)

Features

- Back: Soft mesh or upholstered.
- Seat: Standard upholstered.
- Base: Five-star aluminum base standard.
- Casters: Standard with hard casters; for optional soft casters, see below.
- Mechanism: 3-point tilt.
- Height adjustment: Pneumatic or low-position pneumatic; see below.
- Back stop: Single position.
- Free-floating forward tilt.
- Adjustable lumbar models available, with 1"(25mm) depth and 4"(102mm) height adjustment.
- COM yardage / COL square footage:
Mesh back model: 0.75/15
Fully upholstered model: 1.75/25

To Order, Specify:

- 1) Product number.
- 2) Fabric surface and color (seat).
- 3) Fabric or mesh surface and color (back).
- 4) Trim color for base/back uprights. (Add **\$348.40** for chrome finish.)

* Measurements taken with the BIFMA chair measuring device.

Deep Seat	Back	Number	Fabric Grade		C	D	E	F	G	H	Leather Grade A	Leather Grade B
			A	B								
Pneumatic Height												
Upholstered	Mesh	X621-2044	\$1567.18	\$1607.52	\$1646.64	\$1667.41	\$1683.32	\$1718.77	\$1751.77	\$1842.23	\$1904.58	\$2065.47
Upholstered	Upholstered	X821-2044	1646.64	1727.32	1805.56	1847.10	1878.92	1949.82	2015.82	2196.74	2321.44	2643.22
Pneumatic Height Adjustment with Lumbar												
Upholstered	Mesh	X621-2045	\$1646.64	\$1686.98	\$1726.10	\$1746.87	\$1762.78	\$1798.23	\$1831.23	\$1921.69	\$1984.04	\$2144.93
Upholstered	Upholstered	X821-2045	1726.10	1806.78	1885.02	1926.56	1958.38	2029.28	2095.28	2276.20	2400.90	2722.68

The following options require modification of the product number.

- Soft Caster To specify, change the 7th digit from a **4** (hard caster) to a **2** (soft caster); **Example:** X621-2024
- CAL 133 To specify, add **-F** to end of the product number (add **\$118.58** list)
- Stain repellent To specify, add **-P** to end of the product number; **Example:** X621-2044-P (add **\$39.11** list)
- Low-position Pneumatic Option To specify, change the 4th digit to **3** and 5th digit to **1**; **Example:** X623-1044
- Leather Seat and Mesh Back To specify, change the 2nd digit in mesh back model to **5**; **Example:** X521-2044
- Leather Seat and Leather Back To specify, change the 2nd digit in upholstered back model to **7**; **Example:** X721-2044

NOTE: CAL 133 in available on mesh back models only.

Low-position pneumatic option will have a steel base.

For available fabrics, refer to surfaces.haworth.com.

X99

Task Chair without Arms

Standard Seat



X621-2040

Dimensions*

- *SH: 16" - 20.5"
(406mm - 521mm)
- H: 38.5" - 43"
(978mm-1092mm)
- D: 25"(635mm)
- W: 26"(660mm)
- *SW: 18.6"(472mm)
- *SD: 16"(407mm)

Seat depth adjustment model:
16"-18"(407mm-457mm)

Low-position pneumatic seat-height adjustment range:
15-18"(381mm-457mm)

Features

- Back: Soft mesh or upholstered.
- Seat: Standard upholstered.
- Base: Five-star aluminum base standard.
- Casters: Standard with hard casters; for optional soft casters, see below.
- Mechanism: 3-point tilt.
- Height adjustment: Pneumatic or low-position pneumatic; see below.
- Back stop: Single position.
- Free-floating forward tilt.
- Adjustable lumbar models available, with 1"(25mm) depth and 4"(102mm) height adjustment.
- 3-position seat-depth adjustment models are available with a 3 1/2"(89mm) range.
- COM yardage / COL square footage:
Mesh back model: 0.75/15
Fully upholstered model: 1.75/25

To Order, Specify:

- 1) Product number.
- 2) Fabric surface and color (seat).
- 3) Fabric or mesh surface and color (back).
- 4) Trim color for base/back uprights. (Add **\$348.40** for chrome finish.)

* Measurements taken with the BIFMA chair measuring device.

Seat	Back	Number	Fabric Grade		C	D	E	F	G	H	Leather Grade A	Leather Grade B
			A	B								
Pneumatic Height Adjustment												
Upholstered	Mesh	X621-2040	\$1567.18	\$1607.52	\$1646.64	\$1667.41	\$1683.32	\$1718.77	\$1751.77	\$1842.23	\$1904.58	\$2065.47
Upholstered	Upholstered	X821-2040	1646.64	1727.32	1805.56	1847.10	1878.92	1949.82	2015.82	2196.74	2321.44	2643.22
Pneumatic Height Adjustment with Lumbar												
Upholstered	Mesh	X621-2041	\$1646.64	\$1686.98	\$1726.10	\$1746.87	\$1762.78	\$1798.23	\$1831.23	\$1921.69	\$1984.04	\$2144.93
Upholstered	Upholstered	X821-2041	1726.10	1806.78	1885.02	1926.56	1958.38	2029.28	2095.28	2276.20	2400.90	2722.68
Pneumatic Height Adjustment with Seat Depth Adjustment												
Upholstered	Mesh	X621-2042	\$1727.32	\$1767.66	\$1806.78	\$1827.55	\$1843.46	\$1878.91	\$1911.91	\$2002.37	\$2064.72	\$2225.61
Upholstered	Upholstered	X821-2042	1806.78	1887.46	1965.70	2007.24	2039.06	2109.96	2175.96	2356.88	2481.58	2803.36
Pneumatic Height Adjustment with Lumbar and Seat Depth Adjustment												
Upholstered	Mesh	X621-2043	\$1806.78	\$1847.12	\$1886.24	\$1907.01	\$1922.92	\$1958.37	\$1991.37	\$2081.83	\$2144.18	\$2305.07
Upholstered	Upholstered	X821-2043	1886.24	1966.92	2045.16	2086.70	2118.52	2189.42	2255.42	2436.34	2561.04	2882.82

The following options require modification of the product number.

- Soft Caster To specify, change the 7th digit from a 4 (hard caster) to a 2 (soft caster); **Example:** X621-2020
- CAL 133 To specify, add -F to end of the product number (add **\$118.58** list)
- Stain repellent To specify, add -P to end of the product number; **Example:** X621-2020 (add **\$39.11** list)
- Low-position Pneumatic Option To specify, change the 4th digit to 3 and 5th digit to 1; **Example:** X623-1040
- Leather Seat and Mesh Back To specify, change the 2nd digit in mesh back model to 5; **Example:** X521-2040
- Leather Seat and Leather Back To specify, change the 2nd digit in upholstered back model to 7; **Example:** X721-2040

NOTE: CAL 133 is available on mesh back models only.

Low-position pneumatic option will have a steel base.

For available fabrics, refer to surfaces.haworth.com.

X99

Guest Chair

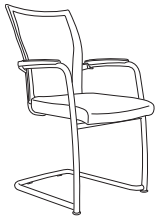

X630-3100

Dimensions*

- *SH: 18"(457mm)
- H: 36"(914)
- D: 24"(610mm)
- W: 22"(559mm)
- *SW: 19"(483mm)
- *SD: 18"(457mm)
- *AH: 8"(203mm)

Features

- Back: Soft mesh or upholstered.
- Seat: Standard upholstered.
- Arms: Black polypropylene arm caps.
- Black glides only.
- Aluminum uprights with welded steel frame.
- COM yardage / COL square footage:
 Mesh back model: 0.5/15
 Fully upholstered model: 1.4/25

To Order, Specify:

- 1) Product number.
- 2) Fabric surface and color (seat).
- 3) Fabric or mesh surface and color (back).
- 4) Trim color for frame.
(Add **\$199.61** for chrome finish.)

* Measurements taken with the BIFMA chair measuring device.

Seat	Back	Arm Caps	Number	Fabric Grade								Leather Grade A	Leather Grade B
				A	B	C	D	E	F	G	H		
Upholstered	Mesh	Standard	X630-3100	\$ 994.48	\$1033.46	\$1071.25	\$1091.32	\$1106.69	\$1140.94	\$1172.83	\$1260.23	\$1320.47	\$1475.92
Upholstered	Upholstered	Standard	X830-3100	1070.08	1148.04	1223.62	1263.76	1294.50	1363.00	1426.78	1601.58	1722.06	2032.96

The following options require modification of the product number.

CAL 133

Stain Repellent

Moisture Barrier with Stain repellent

Leather Seat and Mesh Back Leather

Seat and Leather Back

To specify, add **-F** to end of the product number (add **\$114.57** list)

To specify, add **-P** to end of the product number; **Example:** X630-3100-**P** (add **\$37.79** list)

To specify, add **-D** to end of the product number; **Example:** X630-3100-**D** (add **\$49.60** list)

To specify, change the 2nd digit in mesh back model to **5**; **Example:** X530-3100

To specify, change the 2nd digit in upholstered back model to **7**; **Example:** X730-3100

NOTE: CAL 133 in available on mesh back models only.

For available fabrics, refer to surfaces.haworth.com.

X99

Seminar Chair

With Arms



X840-0140

Dimensions*

- *SH: 18"(457mm)
- H: 36"(914mm)
- D: 24"(610mm)
- W: 22"(559mm)
- *SW: 19"(483mm)
- *SD: 18"(457mm)
- *AH: 8"(203mm)

Features

- Back: Soft mesh or upholstered.
- Seat: Standard upholstered, with folding seat.
- Arms: Black polypropylene arm caps.
- Casters: Standard with hard casters; or optional soft casters, see below.
- Optional black glides, see below.
- Aluminum uprights with welded steel frame.
- Each nested chair adds 7.5"(191mm) of floor space.
- COM yardage / COL square footage:
 Mesh back model: 0.5/15
 Fully upholstered model: 1.4/25
- Casters shipped unassembled.

To Order, Specify:

- 1) Product number.
- 2) Fabric surface and color (seat).
- 3) Fabric or mesh surface and color (back).
- 4) Trim color for frame.
(Add **\$336.62** for chrome finish.)

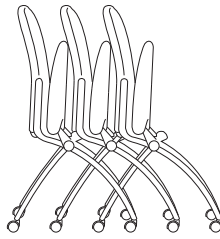

* Measurements taken with the BIFMA chair measuring device.

Seat	Back	Arm Caps	Number	Fabric Grade								Leather Grade A	Leather Grade B
				A	B	C	D	E	F	G	H		
Upholstered	Mesh	Standard	X640-0140	\$ 956.68	\$ 995.66	\$1033.45	\$1053.52	\$1068.89	\$1103.14	\$1135.03	\$1222.43	\$1282.67	\$1438.12
Upholstered	Upholstered	Standard	X840-0140	1032.28	1110.24	1185.82	1225.96	1256.70	1325.20	1388.98	1563.78	1684.26	1995.16

The following options require modification of the product number.

- Soft Caster To specify, change the 7th digit from a 4 (hard caster) to a 2 (soft caster); **Example:** X640-0120
- Glide To specify, change the 7th digit from a 4 (hard caster) to a 0; **Example:** X640-0100
- Leather Seat and Mesh Back To specify, change the 2nd digit in mesh back model to 5; **Example:** X540-0140
- Leather Seat and Leather Back To specify, change the 2nd digit in upholstered back model to 7; **Example:** X740-0140

X99

Seminar Chair

Without Arms



X640-0040

Dimensions*

- *SH: 18"(457mm)
- H: 36"(914mm)
- D: 24"(610mm)
- W: 22"(559mm)
- *SW: 19"(483mm)
- *SD: 18"(457mm)

Features

- Back: Soft mesh or upholstered.
- Seat: Standard upholstered, with folding seat.
- Casters: Standard with hand casters; or optional soft casters, see below.
- Optional black glides, see below.
- Aluminum uprights with welded steel frame.
- COM yardage / COL square footage:
 Mesh back model: 0.5/15
 Fully upholstered model: 1.4/25
- Casters shipped unassembled.

To Order, Specify:

- 1) Product number.
- 2) Fabric surface and color (seat).
- 3) Fabric surface and color (back). (Specify M0-BL for mesh back).
- 4) Trim color for frame. (Add **\$336.62** for chrome finish.)

* Measurements taken with the BIFMA chair measuring device.

Seat	Back	Number	Fabric Grade								Leather Grade A	Leather Grade B
			A	B	C	D	E	F	G	H		
Upholstered	Mesh	X640-0040	\$895.27	\$ 934.25	\$ 972.04	\$ 992.11	\$1007.48	\$1041.73	\$1073.62	\$1161.02	\$1221.26	\$1376.71
Upholstered	Upholstered	X840-0040	970.87	1048.83	1124.41	1164.55	1195.29	1263.79	1327.57	1502.37	1622.85	1933.75

The following options require modification of the product number.

- | | |
|--|--|
| <ul style="list-style-type: none"> Soft Caster Glide CAL 133 Stain repellent Moisture Barrier with Stain Repellent Leather Seat and Mesh Back Leather Seat and Leather Back | <ul style="list-style-type: none"> To specify, change the 7th digit from a 4 (hard caster) to a 2 (soft caster); Example: X640-0020 To specify, change the 7th digit from a 4 (hard caster) to a 0; Example: X640-0000 To specify, add -F to end of the product number (add \$114.57 list) To specify, add -P to end of the product number; Example: X640-0040-P (add \$37.79 list) To specify, add -D to end of the product number; Example: X640-0040-D (add \$49.60 list) To specify, change the 2nd digit in mesh back model to 5; Example: X540-0040 To specify, change the 2nd digit in upholstered back model to 7; Example: X740-0040 |
|--|--|

NOTE: CAL 133 in available on mesh back models only.

For available fabrics, refer to surfaces.haworth.com.

X99

Advanced Seminar Chair

With Arms



X641-2140

Dimensions*

- *SH: 16" - 21"
(406mm - 533mm)
- H: 33 1/2" - 38 1/2"
(851mm - 978mm)
- D: 26 1/2"(673mm)
- W: 26 1/2"(673mm)
- *SW: 18 1/2"(470mm)
- *SD: 16"(406mm)
- *AH: 8"(203mm)

Features

- Back: Soft mesh or upholstered.
- Seat: Standard upholstered.
- Arms: Black polypropylene arm caps.
- Base: Five-star aluminum base.
- Casters: Standard with hard casters; or optional soft casters, see below.
- Back tilts backward 21° from the upright position.
- Optional chrome finish chairs are standard with chrome base, uprights and back crossbar.
- COM yardage / COL square footage:
Mesh back model: 0.5/15
Fully upholstered model: 1.4/25

To Order, Specify:

- 1) Product number.
- 2) Fabric surface and color (seat).
- 3) Fabric or mesh surface and color (back).
- 4) Trim color for frame. (Add **\$336.62** for chrome finish.)

* Measurements taken with the BIFMA chair measuring device.

Seat	Back	Arm Caps	Number	Fabric Grade								Leather Grade A	Leather Grade B
				A	B	C	D	E	F	G	H		
Upholstered	Mesh	Standard	X641-2140	\$1109.07	\$1148.05	\$1185.84	\$1205.91	\$1221.28	\$1255.53	\$1287.42	\$1374.82	\$1435.06	\$1590.51
Upholstered	Upholstered	Standard	X841-2140	1184.67	1262.63	1338.21	1378.35	1409.09	1477.59	1541.37	1716.17	1836.65	2147.55

The following options require modification of the product number.

- Soft Caster To specify, change the 7th digit from a **4** (hard caster) to a **2** (soft caster); **Example:** X641-2120
- Leather Seat and Mesh Back To specify, change the 2nd digit in mesh back model to **5**; **Example:** X541-2140
- Leather Seat and Leather Back To specify, change the 2nd digit in upholstered back model to **7**; **Example:** X741-2140

NOTE: CAL 133 in available on mesh back models with upholstered arms caps only.

X99

Advanced Seminar Chair

Without Arms



X641-2040

Dimensions*

- *SH: 16" - 21"
(406mm - 533mm)
- H: 33 1/2" - 38 1/2"
(851mm - 978mm)
- D: 26 1/2"(673mm)
- W: 26 1/2"(673mm)
- *SW: 18 1/2"(470mm)
- *SD: 16"(406mm)

Features

- Back: Soft mesh or upholstered.
- Seat: Standard upholstered.
- Base: Five-star aluminum base.
- Casters: Standard with hand casters; or optional soft casters, see below.
- Back tilts backward 21° from the upright position.
- Optional chrome finish chairs are standard with chrome base, uprights and back crossbar.
- COM yardage / COL square footage:
Mesh back model: 0.5/15
Fully upholstered model: 1.4/25

To Order, Specify:

- 1) Product number.
- 2) Fabric surface and color (seat).
- 3) Fabric surface and color (back).
- 4) Trim color for frame. (Add **\$336.62** for chrome finish.)

* Measurements taken with the BIFMA chair measuring device.

Seat	Back	Number	Fabric Grade		C	D	E	F	G	H	Leather Grade A	Leather Grade B
			A	B								
Upholstered	Mesh	X641-2040	\$1048.83	\$1087.81	\$1125.60	\$1145.67	\$1161.04	\$1195.29	\$1227.18	\$1314.58	\$1374.82	\$1530.27
Upholstered	Upholstered	X841-2040	1124.43	1202.39	1277.97	1318.11	1348.85	1417.35	1481.13	1655.93	1776.41	2087.31

The following options require modification of the product number.

- Soft Caster
CAL 133
To specify, change the 7th digit from a **4** (hard caster) to a **2** (soft caster); **Example:** X641-2020
To specify, add **-F** to end of the product number (add **\$114.57** list)
- Stain repellent
To specify, add **-P** to end of the product number; **Example:** X641-2040-**P** (add **\$37.79** list)
- Leather Seat and Mesh Back
To specify, change the 2nd digit in mesh back model to **5**; **Example:** X541-2040
- Leather Seat and Leather Back
To specify, change the 2nd digit in upholstered back model to **7**; **Example:** X741-2040

NOTE: For available fabrics, refer to surfaces.haworth.com.

Improv Series

General Specifications

Features and Options (Desk Chairs)

Improv Series desk chairs features:

- Molded-polyfoam, contoured seat and back cushions
- Polypropylene or upholstered outer shell
- Optional steel base with plastic cover
- Hard, dual-wheel casters for carpeted floors (black)
- Optional soft, dual-wheel casters for resilient floor surfaces (black)
- Pneumatic height adjustment
- Optional high arc plastic base
- Loop arms, height-adjustable arms or armless
- Standard hard arm caps or upholstered (fabric, leather, or soft black vinyl) arm caps
- Optional two-stage seat height adjustment and low-position seat height adjustment
- Improv does offer Nano-Tex and DuraBlock on the fully upholstered back chair models.
- Tilt tension

Improv Series desk chairs meet or exceed all ANSI/BIFMA durability standards for office seating.

Mobility and Adjustability (Desk Chairs)

The following features are available on Improv Series desk chair models.



- ▶ Synchronized-tilt (standard)
 - Back and seat recline at a 2:1 ratio with no front seat rise
 - Back tilts backwards 15° from the upright position
 - Seat pan moves downward 7° from the initial position



- ▶ Synchronized-tilt with back-lock
 - Back and seat recline at a 2:1 ratio with no front seat rise
 - Back is lockable in two positions within tilt range
 - Back tilts backwards 15° from the upright position
 - Seat pan moves downward 7° from the initial position
 - Back is lockable in two positions within tilt range, full upright and 5° recline

- ▶ Two-stage seat height adjustment
HAB or 2 stage seat height
(14.3"-21.9"(363mm-556mm))

- ▶ Low-position seat height adjustment
(14"-19"(356mm-483mm))

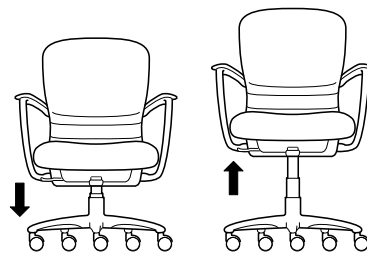

Fully Retracted (.7"(18mm) below standard) Fully Extended (1.9"(48mm) above standard)

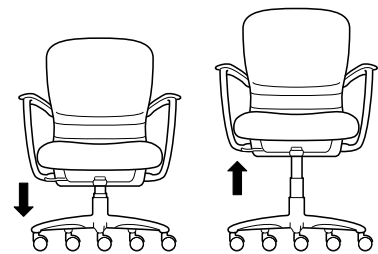

Fully Retracted (1"(25mm) below standard) Fully Extended (1"(25mm) below standard)

- ▶ Optional high arc base

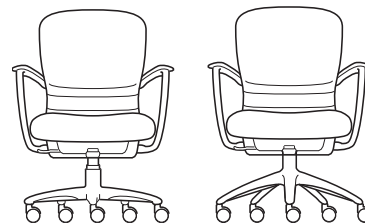

Standard Steel Base High Arc Base
Standard or High Arc Base seat height
(15"-20"(381mm-508mm))

Improv Series

General Specifications

Features and Options (Improv H.E.)

Improv H.E. chairs features:

- Molded-polyfoam, contoured seat and back cushions
- Separate seat and back cushions
- Polypropylene outer shell
- Five-star base with black casters only
- Hard dual-wheel casters (standard) or soft dual-wheel casters (optional)
- Pneumatic seat height adjustment
- Flipper arms, height-adjustable task arms, task arms, 3-D arms or armless
- Optional two-stage seat height adjustment or low-position seat height adjustment
- Optional adjustable air lumbar
- Optional high arc plastic base
- Optional H.E. XL chair for users up to 500 pounds

Mobility and Adjustability (Improv H.E., Tag and S.E.)

The following features are available on Improv H.E. and S.E. chair models (Refer to price page for specific features).



- Synchronized-tilt (standard)
 - Back and seat recline at a 2:1 ratio with no front seat rise
 - Back tilts backward 20° from the upright position
 - Seat pan moves downward 10° from the initial position

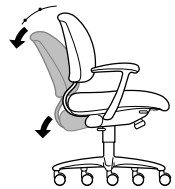

- Synchronized-tilt with back-lock
 - Back and seat recline at a 2:1 ratio with no front seat rise
 - Back is lockable in two positions within tilt range
 - Back tilts backward 20° from the upright position
 - Seat pan moves downward 10° from the initial position



- Forward-tilt
 - Both chair back and seat pan are lockable in three forward positions (1°, 3°, and 5°)

- Adjustable Air Lumbar (H.E. only)
 - Back lumbar has up to 1.5"(38mm) of in/out deflection.

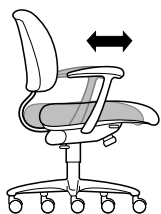

- Seat pan and arms slide horizontally within a 3"(76mm) range

- Two-stage seat height adjustment

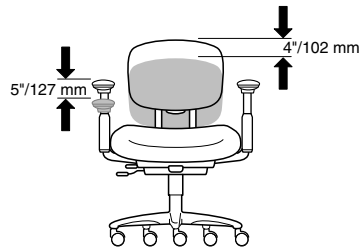

- Back adjusts vertically within a 4"(102mm) range (H.E. only)
- Flipper arms adjust vertically within a 5"(127mm) range

- Low-position seat height adjustment

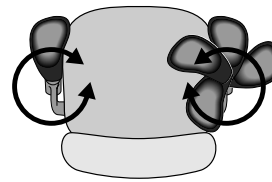

- Flipper arms rotate 360°

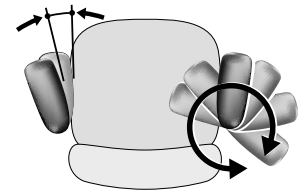

- 3D arms adjust vertically within a 4"(102mm) range and rotate 360°.

- Adjustable Air Lumbar (H.E. only)

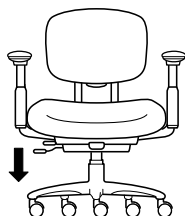

Fully Retracted
(.7"(18mm) below standard)

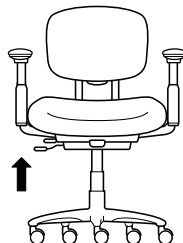

Full Extended
(1.9"(48mm) above standard)

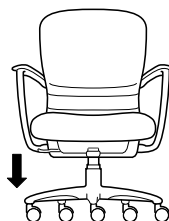

Fully Retracted
(1"(25mm) below standard)

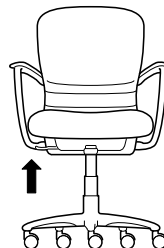

Fully Extended
(1"(25mm) below standard)



- Back lumbar has up to 1.5"(38mm) of in/out deflection.

Improv Series

General Specifications

**Features and Options
(Improv S.E.)**

All Improv S.E. chairs feature

- Molded-polyfoam contoured seat
- Mesh “form fit” back available as round or square
- Five-star plastic high arc base with black casters only
- Hard dual-wheel casters (standard) or soft dual-wheel casters (optional)
- Pneumatic seat height adjustment
- Flipper arms, height-adjustable task arms, task arms, 3-D arms or armless
- Optional two-stage seat height adjustment
- Optional low-position seat height adjustment
- Optional steel base

Mobility and adjustability - Refer to page 180

These two features are not available on Improv S.E.

- Adjustable air lumbar
- Vertical back adjustment

**Features and Options
(Leg-Base and Sled-Base Chairs)**

Improv Series leg-base and sled-base models feature

- 14-gauge elliptical steel tubing legs
- 14-gauge steel side and front stretchers (with arms, tablet and chairs with casters)
- 11-gauge steel front stretchers (without arms)
- Molded polyurethane seat and back foam
- Optional wood back
- Polypropylene or upholstered outer back shell, or full wood back
- High-density polyethylene floor glides (leg-base models)
- Leg base models available with caster option
- Glass-filled nylon sled-base runners with high-density polyethylene floor glides (sled-base models)
- Powder coated frame
- Ganging device option
- Leg-base models with arms stack 6-high (44”(1118mm)) on the floor and 10-high (62”(1575mm)) on the stacking dolly
- Leg-base armless models stack 6-high (44”(1118mm)) on the floor and 10-high (58”(1473mm)) on the stacking dolly
- Leg-base models with casters stack 5-high (42”(1067mm)) on the floor and 6-high (50”(1270mm)) on the stacking dolly
- Wood back model has same stacking capabilities as the leg-base models

Arm chair models feature:

- Glass reinforced polypropylene arms

Armless models feature:

- High-density polyethylene top caps on exposed legs

Tablet arm models feature:

- Right- or left-hand flip-up tablet arm
- 11”(279mm) or 14”(356mm) tablet arms
- Plywood core with high-pressure laminate surface and clear lacquered edge

All Improv table models feature:

- 1”(25mm)-thick particle board core top with laminate or veneer finished surface
- Bullnose PVC or chamfered hardwood edges
- 14-gauge oval steel tube legs
- 3/4” diameter steel stretchers
- High-density polyethylene floor glides
- High-density polyethylene leg top caps

Improv series chairs meet or exceed ANSI/BIFMA durability standards for office seating.

Improv Series

General Specifications

Shipping Weights (Leg-Base and Sled-Base Chairs)

The following weights include packaging materials

- All leg-base and sled-base chairs 25 lbs. per chair/9.6 cubic ft. (up to 3 chairs per carton)
- 20"(508mm) diameter tables 19 lbs./5.3 cubic ft.
- 24" x 48"(610mm x 1219mm) oval tables 35 lbs./11 cubic ft.
- Chairs without tablet arms are packaged three (3) per carton
- Chairs with tablet arms are packaged two (2) per carton
- Chairs with leather seats are packaged one (1) per carton

NOTE: Models with casters: add one (1) pound per chair

Features and Options (Stools)

All Improv Series stools feature

- 14-gauge elliptical steel tubing legs
- 14-gauge steel side and front stretchers
- 14-gauge steel foot rest with lightly textured protective nylon cover
- Molded polyurethane seat foam, 1 3/8"(35mm) thick
- Molded polyurethane back foam, 7/8"(22mm) thick
- Optional wood back
- Polypropylene (3/4"(19mm)) or upholstered (1 1/4"(32mm)) seat and back shell
- High-density polyethylene floor glides
- Glass reinforced polypropylene arms or high-density polyethylene top caps on exposed legs
- Powder coated frame

Shipping Weights (Stools)

The following weights do not include packaging materials.

Stool with arms: 30 lbs./13.608k

Stool without arms: 27 lbs./12.247k

COM & COL General Information

To order a COM fabric (Customer's Own Material), contact the Haworth Inquiry Center (1.800.426.8562), your local Haworth dealer, or go to haworth.com/surfaces > COM Library to find out if the COM you have selected has already been tested and approved. The surface collection site also has information on the Haworth+ alliance program with Carnegie, Luna Textiles, and Maharam as well as our industry-leading Pre-Approved COM program.

COM fabrics are placed into Grades based on the cost per linear yard. If a fabric's cost exceeds the range of our highest Grade it will be noted as Non-Graded. The product will be priced at Grade A; the COM fabric costs will appear as a separate line item. The fabric charge will be Haworth's purchase cost plus a 4% administrative fee (based on the cost of the fabric). Yardage calculations will include any applicable fabric repeat.

COM Leather products will be priced at a leather Grade A; COL costs will appear as a separate line item. The leather costs will be Haworth's purchase cost plus a 4% administrative fee (based on the cost of the leather).

Flammability Requirements

Improv Series models are available with an optional fire retardant construction to comply with California Bulletin #133. Refer to the price pages for ordering information. Refer to the Haworth.com/surfaces for a listing of the approved fabrics.

Environmental Factors

Material Off Gassing

In an effort to ensure air quality standards, all Improv parts suppliers are required to provide Material Data Sheets and/or other documentation, verifying that their products do not emit volatile organic compounds (VOCs). In addition, the powder-coat paint process used in the manufacturing of Improv seating is free of VOCs. Our manufacturing processes have also eliminated all use of chlorofluorocarbons (CFCs) and ozone depleting chemicals (ODCs) in the chair's construction.

Recycling

All fabric scraps are recycled, reducing the amount of material sent to landfills, and all chair components disassemble easily to increase the potential for recycling. In addition, all thermo-plastic parts are 100% reprocessible, and all raw materials used in its manufacturing can be recycled at the end of the useful life of the product. Recyclable parts are identified with the recycle symbol where practical.

Improv Series

General Specifications

General Guidelines for Product Specification

Improv Series seating specification numbers are based on an alpha-numeric logic that identifies a product by model and certain characteristics.

For example, a product number that reads **M221-2241** identifies the product as an Improv high-back chair with seamless upholstered outer shell, pneumatic seat height adjustment, upholstered arms, back-lock, and hard dual-wheel casters.

The alpha-numeric logic for this model complete with fabric and finish codes is shown below:

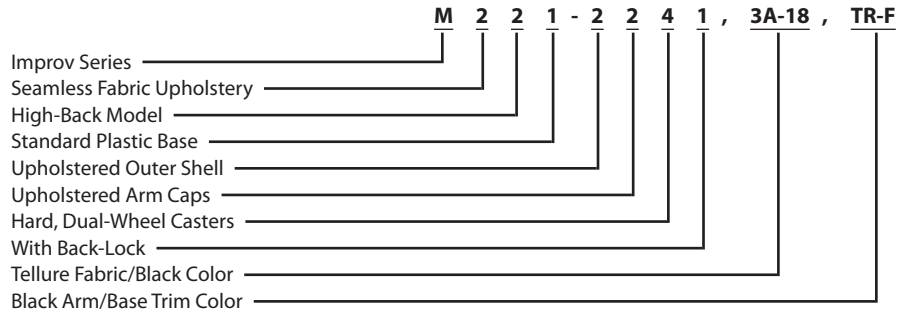

A ninth-digit suffix of the product number will indicate functional option, such as -F for CAL 133 option.

A product number that reads **M245-3942** identifies the product as an Improv S.E. chair with square mesh back, high arc plastic base, soft black vinyl arms, with forward tilt, and hard dual-wheel casters.

The alpha-numeric logic for this model complete with fabric and finish codes is shown below:

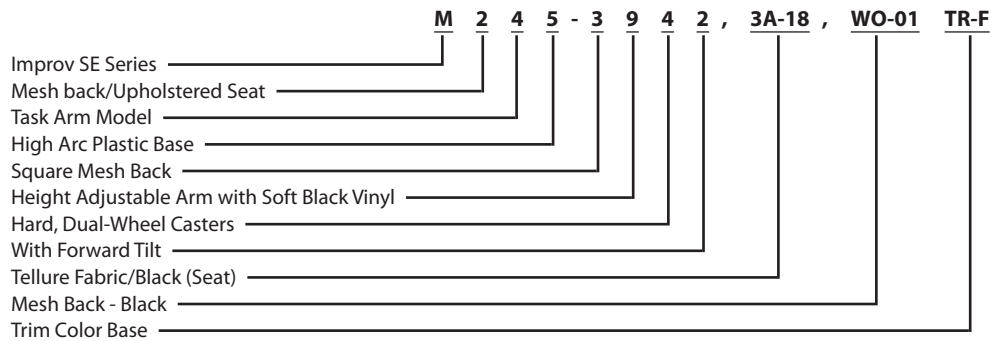

There are exceptions to this logic; therefore, always refer to the price charts for product numbers rather than attempting to construct them. Product number modification instructions for additional options appear in footnoted copy for each applicable model.

Beyond the printed product number, fabric and finish codes are required to complete an order specification. To communicate your order clearly, list the product number and fabric/finish codes in the sequence outlined on each price page.

Finishes and Fabrics

A complete listing of finishes and fabrics for Improv Series desk chairs can be found in the back of the price list.

Improv Series

High-Back Chair with Arms



M221-1142

Dimensions

SH: 15" - 20"
(381mm-508mm)
H: 37 1/2"(953mm)
D: 25"(635mm)
W: 25 1/2"(648mm)
SW: 20 1/2"(521mm)
SD: 16 1/2"(419mm)
AH: 8 11/16"(221mm)
Two-stage seat height:
.7"(18mm) below
standard
1.9"(48mm) above
standard

Features

- Outer Shells: Polypropylene or upholstered.
- Arm Caps: Standard, upholstered fabric or soft black vinyl.
- Casters: Standard with hard casters; or optional soft casters, see below.
- Standard plastic base or optional high arc, or steel base.
- Mechanism: Swivel with synchronized-tilt.
- Height Adjustment: Pneumatic, pneumatic with two-stage seat height, or pneumatic with low position seat height option.
- Optional Back-Lock: Lockable in two positions.
- Tilt tension.
- Fire retardant construction is available to comply with California Bulletin #133, see below.
- COM yardage / COL square footage:
Polypropylene shell: 2.0/44
Upholstered shell: 3.0/66

To Order, Specify:

- 1) Product number.
- 2) Fabric surface and color.
(NOTE: For leather upholstery, see below.)
- 3) Trim color for shell (if applicable), arms and base.

Shells	Arms/Caps	Number	Fabric Grade								Leather Grade A	Leather Grade B
			A	B	C	D	E	F	G	H		
Pneumatic Height Adjustment												
Polypropylene	Standard	M221-1142	\$1123.50	\$1202.86	\$1282.22	\$1324.38	\$1359.12	\$1535.20	\$1624.48	\$1867.54	\$1803.06	\$1987.98
	Upholstered	M221-1242	1180.54	1259.90	1339.26	1381.42	1416.16	1592.24	1681.52	1924.58	1860.10	2045.02
	Soft Black Vinyl	M221-1342	1180.54	1259.90	1339.26	1381.42	1416.16	1592.24	1681.52	1924.58	1860.10	2045.02
Upholstered	Standard	M221-2142	\$1408.72	\$1507.90	\$1612.08	\$1666.66	\$1713.78	\$2026.28	\$2160.18	\$2522.30	\$2318.92	\$2521.22
	Upholstered	M221-2242	1465.76	1564.94	1669.12	1723.70	1770.82	2083.32	2217.22	2579.34	2375.96	2578.26
	Soft Black Vinyl	M221-2342	1465.76	1564.94	1669.12	1723.70	1770.82	2083.32	2217.22	2579.34	2375.96	2578.26
Pneumatic Height Adjustment/Back-Lock												
Polypropylene	Standard	M221-1141	\$1180.54	\$1259.90	\$1339.26	\$1381.42	\$1416.16	\$1592.24	\$1681.52	\$1924.58	\$1860.10	\$2045.02
	Upholstered	M221-1241	1237.58	1316.94	1396.30	1438.46	1473.20	1649.28	1738.56	1981.62	1917.14	2102.06
	Soft Black Vinyl	M221-1341	1237.58	1316.94	1396.30	1438.46	1473.20	1649.28	1738.56	1981.62	1917.14	2102.06
Upholstered	Standard	M221-2141	\$1465.76	\$1564.94	\$1669.12	\$1723.70	\$1770.82	\$2083.32	\$2217.22	\$2579.34	\$2375.96	\$2578.26
	Upholstered	M221-2241	1522.80	1621.98	1726.16	1780.74	1827.86	2140.36	2274.26	2636.38	2433.00	2635.30
	Soft Black Vinyl	M221-2341	1522.80	1621.98	1726.16	1780.74	1827.86	2140.36	2274.26	2636.38	2433.00	2635.30

The following options require modification of the product number.

- Low-position seat height - Plastic
- Two-stage seat height- HAB
- High arc base
- Steel base - Standard
- Steel base - Low height
- Soft casters
- Leather upholstery
- CAL 133
- Stain repellent

- To specify, change the 4th digit from a 1 to a 4; **Example:** M224-1142
- To specify, change the 4th digit from a 1 to a 3; **Example:** M223-1142 (add \$102.93 list)
- To specify, change the 4th digit from a 1 to a 5; **Example:** M225-1142
- To specify, change the 4th digit from a 1 to a 6; **Example:** M226-1142
- To specify, change the 4th digit from a 1 to a 7; **Example:** M227-1142
- To specify, change the 7th digit from a 4 to a 2; **Example:** M221-1122
- To specify, change the 2nd digit from a 2 to a 1; **Example:** M121-1142
- To specify, add **-F** to the end of the product number; **Example:** M221-1142-F (add \$120.28 list)
- To specify, add **-P** to end of the product number; **Example:** M221-1141-P (add \$39.68 list)

NOTE: For available fabrics, refer to surfaces.haworth.com.

Improv Series

High-Back Chair with Height Adjustable Arms



M221-1742

Dimensions

SH: 15" - 20"
(381mm-508mm)
H: 37 1/2"(953mm)
D: 25"(635mm)
W: 27 1/4"(692mm)
SW: 20 1/2"(521mm)
SD: 16 1/2"(419mm)
AH: 7" - 11"
(179mm-279mm)

Two-stage seat height:
.7"(18mm) below
standard
1.9"(48mm) above
standard

Features

- Outer Shells: Polypropylene or upholstered.
- Arm Caps: Standard, upholstered fabric or soft black vinyl.
- Arm Adjustment Controls: Fingertip activation.
- Arm Adjustment: 4"(102mm) height adjustment at a 13° angle.
- Casters: Standard with hard casters; or optional soft casters, see below.
- Standard plastic base or optional high arc, or steel base.
- Mechanism: Swivel with synchronized-tilt.
- Height Adjustment: Pneumatic, pneumatic with two-stage seat height, or pneumatic with low position seat height option.
- Optional Back-Lock: Lockable in two positions.
- Tilt tension.
- COM yardage / COL square footage:
Polypropylene shell: 2.0/44
Upholstered shell: 3.0/66

To Order, Specify:

- 1) Product number.
- 2) Fabric surface and color.
(NOTE: For leather upholstery, see below.)
- 3) Trim color for shell (if applicable), arms and base.

Shells	Arms/Caps	Number	Fabric Grade								Leather Grade A	Leather Grade B
			A	B	C	D	E	F	G	H		
Pneumatic Height Adjustment												
Polypropylene	Standard	M221-1742	\$1256.17	\$1335.53	\$1414.89	\$1457.05	\$1491.79	\$1667.87	\$1757.15	\$2000.21	\$1935.73	\$2120.65
	Upholstered	M221-1842	1313.21	1392.57	1471.93	1514.09	1548.83	1724.91	1814.19	2057.25	1992.77	2177.69
	Soft Black Vinyl	M221-1942	1313.21	1392.57	1471.93	1514.09	1548.83	1724.91	1814.19	2057.25	1992.77	2177.69
Upholstered	Standard	M221-2742	\$1541.39	\$1640.57	\$1744.75	\$1799.33	\$1846.45	\$2158.95	\$2292.85	\$2654.97	\$2451.59	\$2653.89
	Upholstered	M221-2842	1598.43	1697.61	1801.79	1856.37	1903.49	2215.99	2349.89	2712.01	2508.63	2710.93
	Soft Black Vinyl	M221-2942	1598.43	1697.61	1801.79	1856.37	1903.49	2215.99	2349.89	2712.01	2508.63	2710.93
Pneumatic Height Adjustment/Back-Lock												
Polypropylene	Standard	M221-1741	\$1313.21	\$1392.57	\$1471.93	\$1514.09	\$1548.83	\$1724.91	\$1814.19	\$2057.25	\$1992.77	\$2177.69
	Upholstered	M221-1841	1370.25	1449.61	1528.97	1571.13	1605.87	1781.95	1871.23	2114.29	2049.81	2234.73
	Soft Black Vinyl	M221-1941	1370.25	1449.61	1528.97	1571.13	1605.87	1781.95	1871.23	2114.29	2049.81	2234.73
Upholstered	Standard	M221-2741	\$1598.43	\$1697.61	\$1801.79	\$1856.37	\$1903.49	\$2215.99	\$2349.89	\$2712.01	\$2508.63	\$2710.93
	Upholstered	M221-2841	1655.47	1754.65	1858.83	1913.41	1960.53	2273.03	2406.93	2769.05	2565.67	2767.97
	Soft Black Vinyl	M221-2941	1655.47	1754.65	1858.83	1913.41	1960.53	2273.03	2406.93	2769.05	2565.67	2767.97

The following options require modification of the product number.

- | | |
|------------------------------------|--|
| Low-position seat height - Plastic | To specify, change the 4th digit from a 1 to a 4; Example: M224-1742 |
| Two-stage seat height- HAB | To specify, change the 4th digit from a 1 to a 3; Example: M223-1742 (add \$102.93 list) |
| High arc base | To specify, change the 4th digit from a 1 to a 5; Example: M225-1742 |
| Steel base - Standard height | To specify, change the 4th digit from a 1 to a 6; Example: M226-1742 |
| Steel base - Low height | To specify, change the 4th digit from a 1 to a 7; Example: M227-1742 |
| Soft casters | To specify, change the 7th digit from a 4 to a 2; Example: M221-1722 |
| Leather upholstery | To specify, change the 2nd digit from a 2 to a 1; Example: M121-1742 |
| Stain repellent | To specify, add -P to the end of the product number; Example: M221-1742-P (add \$39.68 list) |
- NOTE:** For available fabrics, refer to surfaces.haworth.com.

Improv Series

High-Back Chair without Arms



M221-1042

Dimensions

SH: 15" - 20"
(381mm-508mm)
H: 37 1/2"(953mm)
D: 25"(635mm)
W: 20 1/2"(521mm)
SW: 20 1/2"(521mm)
SD: 16 1/2"(419mm)

Two-stage seat height:
.7"(18mm) below
standard
1.9"(48mm) above
standard

Features

- Outer Shells: Polypropylene or upholstered.
- Casters: Standard with hard casters; or optional soft casters, see below.
- Standard plastic base or optional high arc, or steel base.
- Mechanism: Swivel with synchronized-tilt.
- Height Adjustment: Pneumatic, pneumatic with two-stage seat height, or pneumatic with low-position seat height option.
- Optional Back-Lock: Lockable in two positions.
- Tilt tension.
- Fire retardant construction is available to comply with California Bulletin #133, see below.
- COM yardage / COL square footage:
Polypropylene shell: 2.0/44
Upholstered shell: 3.0/66

To Order, Specify:

- 1) Product number.
- 2) Fabric surface and color. (NOTE: For leather upholstery, see below.)
- 3) Trim color for shell (if applicable) and base.

Shells	Number	Fabric Grade								Leather Grade A	Leather Grade B
		A	B	C	D	E	F	G	H		
Pneumatic Height Adjustment											
Polypropylene	M221-1042	\$1030.49	\$1109.85	\$1189.21	\$1231.37	\$1266.11	\$1442.19	\$1531.47	\$1774.53	\$1710.05	\$1894.97
Upholstered	M221-2042	1315.71	1414.89	1519.07	1573.65	1620.77	1933.27	2067.17	2429.29	2225.91	2428.21
Pneumatic Height Adjustment/Back-Lock											
Polypropylene	M221-1041	\$1087.53	\$1166.89	\$1246.25	\$1288.41	\$1323.15	\$1499.23	\$1588.51	\$1831.57	\$1767.09	\$1952.01
Upholstered	M221-2041	1372.75	1471.93	1576.11	1630.69	1677.81	1990.31	2124.21	2486.33	2282.95	2485.25

The following options require modification of the product number.

- | | |
|------------------------------------|--|
| Low-position seat height - Plastic | To specify, change the 4th digit from a 1 to a 4; Example: M224-1042 |
| Two-stage seat height- HAB | To specify, change the 4th digit from a 1 to a 3; Example: M223-1042 (add \$102.93 list) |
| High arc base | To specify, change the 4th digit from a 1 to a 5; Example: M225-1042 |
| Steel base - Standard height | To specify, change the 4th digit from a 1 to a 6; Example: M226-1042 |
| Steel base - Low height | To specify, change the 4th digit from a 1 to a 7; Example: M227-1042 |
| Soft casters | To specify, change the 7th digit from a 4 to a 2; Example: M221-1022 |
| Leather upholstery | To specify, change the 2nd digit from a 2 to a 1; Example: M121-1042 |
| CAL 133 | To specify, add -F to the end of the product number; Example: M221-1042-F (add \$120.28 list) |
| Stain repellent | To specify, add -P to the end of the product number; Example: M221-1042-P (add \$39.68 list) |

NOTE: For available fabrics, refer to surfaces.haworth.com.

Improv Series

Mid-Back Chair with Arms



M211-1142

Dimensions

SH: 15" - 20"
(381mm-508mm)
H: 34 1/2"(876mm)
D: 25"(635mm)
W: 25 1/2"(648mm)
SW: 20 1/2"(521mm)
SD: 16 1/2"(419mm)
AH: 8 11/16"(221mm)

Two-stage seat height:
.7"(18mm) below
standard
1.9"(48mm) above
standard

Features

- Outer Shells: Polypropylene or upholstered.
- Arm Caps: Standard, upholstered fabric or soft black vinyl.
- Casters: Standard with hard casters; or optional soft casters, see below.
- Standard plastic base or optional high arc, or steel base.
- Mechanism: Swivel with synchronized-tilt.
- Height Adjustment: Pneumatic, pneumatic with two-stage seat height, or pneumatic with low-position seat height option.
- Optional Back-Lock: Lockable in two positions.
- Tilt tension.
- Fire retardant construction is available to comply with California Bulletin #133, see below.
- COM yardage / COL square footage:
Polypropylene shell: 1.75/39
Upholstered shell: 2.75/61

To Order, Specify:

- 1) Product number.
- 2) Fabric surface and color.
(NOTE: For leather upholstery, see below.)
- 3) Trim color for shell (if applicable), arms and base.

Shells	Arms/Caps	Number	Fabric Grade								Leather Grade A	Leather Grade B
			A	B	C	D	E	F	G	H		
Pneumatic Height Adjustment												
Polypropylene	Standard	M211-1142	\$ 992.05	\$1071.41	\$1150.77	\$1192.93	\$1227.67	\$1403.75	\$1493.03	\$1736.09	\$1671.61	\$1856.53
	Upholstered	M211-1242	1049.09	1128.45	1207.81	1249.97	1284.71	1460.79	1550.07	1793.13	1728.65	1913.57
	Soft Black Vinyl	M211-1342	1049.09	1128.45	1207.81	1249.97	1284.71	1460.79	1550.07	1793.13	1728.65	1913.57
Upholstered	Standard	M211-2142	\$1277.27	\$1376.45	\$1480.63	\$1535.21	\$1582.33	\$1894.83	\$2028.73	\$2390.85	\$2187.47	\$2389.77
	Upholstered	M211-2242	1334.31	1433.49	1537.67	1592.25	1639.37	1951.87	2085.77	2447.89	2244.51	2446.81
	Soft Black Vinyl	M211-2342	1334.31	1433.49	1537.67	1592.25	1639.37	1951.87	2085.77	2447.89	2244.51	2446.81
Pneumatic Height Adjustment/Back-Lock												
Polypropylene	Standard	M211-1141	\$1049.09	\$1128.45	\$1207.81	\$1249.97	\$1284.71	\$1460.79	\$1550.07	\$1793.13	\$1728.65	\$1913.57
	Upholstered	M211-1241	1106.13	1185.49	1264.85	1307.01	1341.75	1517.83	1607.11	1850.17	1785.69	1970.61
	Soft Black Vinyl	M211-1341	1106.13	1185.49	1264.85	1307.01	1341.75	1517.83	1607.11	1850.17	1785.69	1970.61
Upholstered	Standard	M211-2141	\$1334.31	\$1433.49	\$1537.67	\$1592.25	\$1639.37	\$1951.87	\$2085.77	\$2447.89	\$2244.51	\$2446.81
	Upholstered	M211-2241	1391.35	1490.53	1594.71	1649.29	1696.41	2008.91	2142.81	2504.93	2301.55	2503.85
	Soft Black Vinyl	M211-2341	1391.35	1490.53	1594.71	1649.29	1696.41	2008.91	2142.81	2504.93	2301.55	2503.85

The following options require modification of the product number.

Low-position seat height - Plastic	To specify, change the 4th digit from a 1 to a 4; Example: M214-1142
Two-stage seat height- HAB	To specify, change the 4th digit from a 1 to a 3; Example: M213-1142 (add \$102.93 list)
High arc base	To specify, change the 4th digit from a 1 to a 5; Example: M215-1142
Steel base - Standard height	To specify, change the 4th digit from a 1 to a 6; Example: M216-1142
Steel base - Low height	To specify, change the 4th digit from a 1 to a 7; Example: M217-1142
Soft casters	To specify, change the 7th digit from a 4 to a 2; Example: M211-1122
Leather upholstery	To specify, change the 2nd digit from a 2 to a 1; Example: M111-1142
CAL 133	To specify, add -F to the end of the product number; Example: M211-1142-F (add \$120.28 list)
Stain repellent	To specify, add -P to the end of the product number; Example: M211-1142-P (add \$39.68 list)

NOTE: For available fabrics, refer to surfaces.haworth.com.

Improv Series

Mid-Back Chair with Height Adjustable Arms



M211-1742

Dimensions

SH: 15" - 20"
(381mm-508mm)
H: 34 1/2"(876mm)
D: 25"(635mm)
W: 27 1/4"(692mm)
SW: 20 1/2"(521mm)
SD: 16 1/2"(419mm)
AH: 7" - 11"
(179mm-279mm)

Two-stage seat height:
.7"(18mm) below
standard
1.9"(48mm) above
standard

Features

- Outer Shells: Polypropylene or upholstered.
- Arms: Standard, upholstered fabric or soft black vinyl arm caps.
- Arm Adjustment Controls: Fingertip activation.
- Casters: Standard with hard casters; for optional soft casters, see below.
- Standard plastic base or optional high arc, or steel base.
- Mechanism: Swivel with synchronized-tilt.
- Height Adjustment: Pneumatic, pneumatic with two-stage seat height, or pneumatic with low-position seat height option.
- Arm Adjustment: 4"(102mm) height adjustment at a 13° angle.
- Optional Back-Lock: Lockable in two positions.
- Tilt tension.
- COM yardage / COL square footage:
Polypropylene shell: 1.75/39
Upholstered shell: 2.75/61

To Order, Specify:

- 1) Product number.
- 2) Fabric surface and color. (NOTE: For leather upholstery, see below.)
- 3) Trim color for shell (if applicable), arms and base.

Shells	Arms/Caps	Number	Fabric Grade								Leather Grade A	Leather Grade B
			A	B	C	D	E	F	G	H		
Pneumatic Height Adjustment												
Polypropylene	Standard	M211-1742	\$1124.72	\$1204.08	\$1283.44	\$1325.60	\$1360.34	\$1536.42	\$1625.70	\$1868.76	\$1804.28	\$1989.20
	Upholstered	M211-1842	1181.76	1261.12	1340.48	1382.64	1417.38	1593.46	1682.74	1925.80	1861.32	2046.24
	Soft Black Vinyl	M211-1942	1181.76	1261.12	1340.48	1382.64	1417.38	1593.46	1682.74	1925.80	1861.32	2046.24
Upholstered	Standard	M211-2742	\$1409.94	\$1509.12	\$1613.30	\$1667.88	\$1715.00	\$2027.50	\$2161.40	\$2523.52	\$2320.14	\$2522.44
	Upholstered	M211-2842	1466.98	1566.16	1670.34	1724.92	1772.04	2084.54	2218.44	2580.56	2377.18	2579.48
	Soft Black Vinyl	M211-2942	1466.98	1566.16	1670.34	1724.92	1772.04	2084.54	2218.44	2580.56	2377.18	2579.48
Pneumatic Height Adjustment/Back-Lock												
Polypropylene	Standard	M211-1741	\$1181.76	\$1261.12	\$1340.48	\$1382.64	\$1417.38	\$1593.46	\$1682.74	\$1925.80	\$1861.32	\$2046.24
	Upholstered	M211-1841	1238.80	1318.16	1397.52	1439.68	1474.42	1650.50	1739.78	1982.84	1918.36	2103.28
	Soft Black Vinyl	M211-1941	1238.80	1318.16	1397.52	1439.68	1474.42	1650.50	1739.78	1982.84	1918.36	2103.28
Upholstered	Standard	M211-2741	\$1466.98	\$1566.16	\$1670.34	\$1724.92	\$1772.04	\$2084.54	\$2218.44	\$2580.56	\$2377.18	\$2579.48
	Upholstered	M211-2841	1524.02	1623.20	1727.38	1781.96	1829.08	2141.58	2275.48	2637.60	2434.22	2636.52
	Soft Black Vinyl	M211-2941	1524.02	1623.20	1727.38	1781.96	1829.08	2141.58	2275.48	2637.60	2434.22	2636.52

The following options require modification of the product number.

- Low-position seat height - Plastic
- Two-stage seat height- HAB
- High arc base
- Steel base - Standard height
- Steel base - Low height
- Soft casters
- Leather upholstery
- Stain repellent

- To specify, change the 4th digit from a 1 to a 4; **Example:** M214-1742
- To specify, change the 4th digit from a 1 to a 3; **Example:** M213-1742 (add \$102.93 list)
- To specify, change the 4th digit from a 1 to a 5; **Example:** M215-1742
- To specify, change the 4th digit from a 1 to a 6; **Example:** M216-1742
- To specify, change the 4th digit from a 1 to a 7; **Example:** M217-1742
- To specify, change the 7th digit from a 4 to a 2; **Example:** M211-1722
- To specify, change the 2nd digit from a 2 to a 1; **Example:** M111-1742
- To specify, add **-P** to the end of the product number; **Example:** M211-1742-P (add \$39.68 list)

NOTE: For available fabrics, refer to surfaces.haworth.com.

Improv Series

Mid-Back Chair without Arms

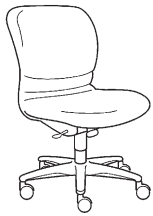

M211-1042

Dimensions

SH: 15" - 20"
(381mm-508mm)
H: 34 1/2"(876mm)
D: 25"(635mm)
W: 20 1/2"(521mm)
SW: 20 1/2"(521mm)
SD: 16 1/2"(419mm)

Two-stage seat height:
.7"(18mm) below
standard
1.9"(48mm) above
standard

Features

- Outer Shells: Polypropylene or upholstered.
- Casters: Standard with hard casters; or optional soft casters, see below.
- Standard plastic base or optional high arc, or steel base.
- Mechanism: Swivel with synchronized-tilt.
- Height Adjustment: Pneumatic, pneumatic with two-stage seat height, or pneumatic with low-position seat height option.
- Optional Back-Lock: Lockable in two positions.
- Tilt tension.
- Fire retardant construction is available to comply with California Bulletin #133, see below.
- COM yardage / COL square footage:
Polypropylene shell: 1.75/39
Upholstered shell: 2.75/61

To Order, Specify:

- 1) Product number.
- 2) Fabric surface and color. (NOTE: For leather upholstery, see below.)
- 3) Trim color for shell (if applicable) and base.

Shells	Number	Fabric Grade								Leather Grade A	Leather Grade B
		A	B	C	D	E	F	G	H		
Pneumatic Height Adjustment											
Polypropylene	M211-1042	\$ 899.04	\$ 978.40	\$1057.76	\$1099.92	\$1134.66	\$1310.74	\$1400.02	\$1643.08	\$1578.60	\$1763.52
Upholstered	M211-2042	1184.26	1283.44	1387.62	1442.20	1489.32	1801.82	1935.72	2297.84	2094.46	2296.76
Pneumatic Height Adjustment/Back-Lock											
Polypropylene	M211-1041	\$ 956.08	\$1035.44	\$1114.80	\$1156.96	\$1191.70	\$1367.78	\$1457.06	\$1700.12	\$1635.64	\$1820.56
Upholstered	M211-2041	1241.30	1340.48	1444.66	1499.24	1546.36	1858.86	1992.76	2354.88	2151.50	2353.80

The following options require modification of the product number.

- | | |
|------------------------------------|--|
| Low-position seat height - Plastic | To specify, change the 4th digit from a 1 to a 4; Example: M214-1042 |
| Two-stage seat height- HAB | To specify, change the 4th digit from a 1 to a 3; Example: M213-1042 (add \$102.93 list) |
| High arc base | To specify, change the 4th digit from a 1 to a 5; Example: M215-1042 |
| Steel base - Standard height | To specify, change the 4th digit from a 1 to a 6; Example: M216-1042 |
| Steel base - Low height | To specify, change the 4th digit from a 1 to a 7; Example: M217-1042 |
| Soft casters | To specify, change the 7th digit from a 4 to a 2; Example: M211-1022 |
| Leather upholstery | To specify, change the 2nd digit from a 2 to a 1; Example: M111-1042 |
| CAL 133 | To specify, add -F to the end of the product number; Example: M211-1042-F (add \$120.28 list) |
| Stain repellent | To specify, add -P to the end of the product number; Example: M211-1042-P (add \$39.68 list) |

NOTE: For available fabrics, refer to surfaces.haworth.com.

Improv Series

Improv H.E. XL Chair with Task Arms



M271-1442

Dimensions

SH:	16" - 20 1/2" (406mm - 521mm)
H:	36 1/2" - 45" (957mm - 1143mm)
D:	23 1/2" - 26 1/2" (597mm - 673mm)
W:	30"(762mm)
SW:	23 3/4"(603mm)
SD:	16" - 19" (406mm - 483mm)
AH:	9.6"(244mm)

Features

- Accommodates up to 500 pounds.
- Outer Shells: Polypropylene or upholstered.
- Arms: Standard, upholstered fabric or soft black vinyl arm caps.
- Casters: Standard with hard casters.
- Mechanism: Swivel with synchronized-tilt.
- Height Adjustment: Pneumatic.
- Optional Back-Lock: Lockable in two positions.
- Optional Forward Tilt: Lockable in 3 positions.
- Tilt tension.
- Optional Adjustable Air Lumbar additional 1 1/2"(38mm) of lumbar support.
- Fire retardant construction is available to comply with California Bulletin #133.
- COM yardage / COL square footage:
Polypropylene shell: 2.41/51
Upholstered shell: 3.31/75

To Order, Specify:

- 1) Product number.
- 2) Fabric surface and color. (NOTE: For leather upholstery, see page 191.)
- 3) Trim color for shell, arms and base.

* All measurements taken with the BIFMA chair measuring device.

Shells	Arms/Caps	Number	Fabric Grade								Leather Grade A	Leather Grade B
			A	B	C	D	E	F	G	H		
Pneumatic Height Adjustment												
Polypropylene	Standard	M271-1442	\$2255.66	\$2333.80	\$2415.62	\$2456.54	\$2492.48	\$2564.44	\$2630.14	\$2812.44	\$2938.90	\$3126.06
	Upholstered	M271-1542	2308.99	2387.13	2468.95	2509.87	2545.81	2617.77	2683.47	2865.77	2992.23	3179.39
	Soft Black Vinyl	M271-1642	2308.99	2387.13	2468.95	2509.87	2545.81	2617.77	2683.47	2865.77	2992.23	3179.39
Upholstered	Standard	M271-2442	\$2384.63	\$2462.77	\$2544.59	\$2585.51	\$2621.45	\$2693.41	\$2759.11	\$2941.41	\$3302.25	\$3489.41
	Upholstered	M271-2542	2437.96	2516.10	2597.92	2638.84	2674.78	2746.74	2812.44	2994.74	3355.58	3542.74
	Soft Black Vinyl	M271-2642	2437.96	2516.10	2597.92	2638.84	2674.78	2746.74	2812.44	2994.74	3355.58	3542.74
Pneumatic Height Adjustment/Back-Lock												
Polypropylene	Standard	M271-1441	\$2308.99	\$2387.13	\$2468.95	\$2509.87	\$2545.81	\$2617.77	\$2683.47	\$2865.77	\$2992.23	\$3179.39
	Upholstered	M271-1541	2362.32	2440.46	2522.28	2563.20	2599.14	2671.10	2736.80	2919.10	3045.56	3232.72
	Soft Black Vinyl	M271-1641	2362.32	2440.46	2522.28	2563.20	2599.14	2671.10	2736.80	2919.10	3045.56	3232.72
Upholstered	Standard	M271-2441	\$2437.96	\$2516.10	\$2597.92	\$2638.84	\$2674.78	\$2746.74	\$2812.44	\$2994.74	\$3355.58	\$3542.74
	Upholstered	M271-2541	2491.29	2569.43	2651.25	2692.17	2728.11	2800.07	2865.77	3048.07	3408.91	3596.07
	Soft Black Vinyl	M271-2641	2491.29	2569.43	2651.25	2692.17	2728.11	2800.07	2865.77	3048.07	3408.91	3596.07
Pneumatic Height Adjustment/Forward-Tilt												
Polypropylene	Standard	M281-1442	\$2307.74	\$2385.88	\$2467.70	\$2508.62	\$2544.56	\$2616.52	\$2682.22	\$2864.52	\$2990.98	\$3178.14
	Upholstered	M281-1542	2361.07	2439.21	2521.03	2561.95	2597.89	2669.85	2735.55	2917.85	3044.31	3231.47
	Soft Black Vinyl	M281-1642	2361.07	2439.21	2521.03	2561.95	2597.89	2669.85	2735.55	2917.85	3044.31	3231.47
Upholstered	Standard	M281-2442	\$2436.71	\$2514.85	\$2596.67	\$2637.59	\$2673.53	\$2745.49	\$2811.19	\$2993.49	\$3354.33	\$3541.49
	Upholstered	M281-2542	2490.04	2568.18	2650.00	2690.92	2726.86	2798.82	2864.52	3046.82	3407.66	3594.82
	Soft Black Vinyl	M281-2642	2490.04	2568.18	2650.00	2690.92	2726.86	2798.82	2864.52	3046.82	3407.66	3594.82

Improv Series

Improv H.E. XL Chair with Task Arms

Shells	Arms/Caps	Number	Fabric Grade								Leather Grade A	Leather Grade B
			A	B	C	D	E	F	G	H		
Pneumatic Height Adjustment with Adjustable Air Lumbar												
Polypropylene	Standard	M271-1444	\$2384.63	\$2462.77	\$2544.59	\$2585.51	\$2621.45	\$2693.41	\$2759.11	\$2941.41	\$3067.87	\$3255.03
	Upholstered	M271-1544	2437.96	2516.10	2597.92	2638.84	2674.78	2746.74	2812.44	2994.74	3121.20	3308.36
	Soft Black Vinyl	M271-1644	2437.96	2516.10	2597.92	2638.84	2674.78	2746.74	2812.44	2994.74	3121.20	3308.36
Upholstered	Standard	M271-2444	\$2513.60	\$2591.74	\$2673.56	\$2714.48	\$2750.42	\$2822.38	\$2888.08	\$3070.38	\$3431.22	\$3618.38
	Upholstered	M271-2544	2566.93	2645.07	2726.89	2767.81	2803.75	2875.71	2941.41	3123.71	3484.55	3671.71
	Soft Black Vinyl	M271-2644	2566.93	2645.07	2726.89	2767.81	2803.75	2875.71	2941.41	3123.71	3484.55	3671.71
Pneumatic Height Adjustment/Back-Lock with Adjustable Air Lumbar												
Polypropylene	Standard	M271-1443	\$2437.96	\$2516.10	\$2597.92	\$2638.84	\$2674.78	\$2746.74	\$2812.44	\$2994.74	\$3121.20	\$3308.36
	Upholstered	M271-1543	2491.29	2569.43	2651.25	2692.17	2728.11	2800.07	2865.77	3048.07	3174.53	3361.69
	Soft Black Vinyl	M271-1643	2491.29	2569.43	2651.25	2692.17	2728.11	2800.07	2865.77	3048.07	3174.53	3361.69
Upholstered	Standard	M271-2443	\$2566.93	\$2645.07	\$2726.89	\$2767.81	\$2803.75	\$2875.71	\$2941.41	\$3123.71	\$3484.55	\$3671.71
	Upholstered	M271-2543	2620.26	2698.40	2780.22	2821.14	2857.08	2929.04	2994.74	3177.04	3537.88	3725.04
	Soft Black Vinyl	M271-2643	2620.26	2698.40	2780.22	2821.14	2857.08	2929.04	2994.74	3177.04	3537.88	3725.04
Pneumatic Height Adjustment/Forward-Tilt with Adjustable Air Lumbar												
Polypropylene	Standard	M281-1444	\$2436.71	\$2514.85	\$2596.67	\$2637.59	\$2673.53	\$2745.49	\$2811.19	\$2993.49	\$3119.95	\$3307.11
	Upholstered	M281-1544	2490.04	2568.18	2650.00	2690.92	2726.86	2798.82	2864.52	3046.82	3173.28	3360.44
	Soft Black Vinyl	M281-1644	2490.04	2568.18	2650.00	2690.92	2726.86	2798.82	2864.52	3046.82	3173.28	3360.44
Upholstered	Standard	M281-2444	\$2565.68	\$2643.82	\$2725.64	\$2766.56	\$2802.50	\$2874.46	\$2940.16	\$3122.46	\$3483.30	\$3670.46
	Upholstered	M281-2544	2619.01	2697.15	2778.97	2819.89	2855.83	2927.79	2993.49	3175.79	3536.63	3723.79
	Soft Black Vinyl	M281-2644	2619.01	2697.15	2778.97	2819.89	2855.83	2927.79	2993.49	3175.79	3536.63	3723.79

The following options require modification of the product number.

Faux Leather upholstery
 Leather upholstery
 CAL 133
 Stain repellent

To specify, change the 2nd digit from a 2 to a 3; **Example:** M371-1542

To specify, change the 2nd digit from a 2 to a 1; **Example:** M171-1542

To specify, add -F to the end of the product number; **Example:** M271-2542-F (add \$120.28 list)

To specify, add -P to the end of the product number; **Example:** M271-1442-P (add \$39.68 list)

NOTE: CAL 133 is available on all fully upholstered models and chairs with black (TR-F) polypropylene shells backs.

For available fabrics, refer to surfaces.haworth.com.

Improv Series

Improv H.E. XL Chair with Height Adjustable Task Arms



M271-1742

Dimensions

SH: 16" - 20 1/2"
(406mm - 521mm)
H: 36 1/2" - 45"
(957mm - 1143mm)
D: 23 1/2" - 26 1/2"
(597mm - 673mm)
W: 30"(762mm)
SW: 23 3/4"(603mm)
SD: 16" - 19"
(406mm - 483mm)
AH: 6.9" - 10.8"
(175mm - 274mm)

Features

- Accommodates up to 500 pounds.
- Outer Shells: Polypropylene or upholstered.
- Arms: Standard, upholstered fabric or soft black vinyl arm caps.
- Arm Adjustment Controls: Fingertip activation.
- Arm Adjustment: 4"(102mm) height adjustment.
- Casters: Standard with hard casters.
- Mechanism: Swivel with synchronized-tilt.
- Height Adjustment: Pneumatic.
- Optional Back-Lock: Lockable in two positions.
- Optional Forward Tilt: Lockable in 3 positions.
- Tilt tension
- Optional Adjustable Air Lumbar: additional 1 1/2"(38mm) of lumbar support.
- COM yardage / COL square footage:
Polypropylene shell: 2.41/51
Upholstered shell: 3.31/75

To Order, Specify:

- 1) Product number.
- 2) Fabric surface and color. (NOTE: For leather upholstery, see page 193.)
- 3) Trim color for shell, arms and base.

* All measurements taken with the BIFMA chair measuring device.

Shells	Arms/Caps	Number	Fabric Grade								Leather Grade A	Leather Grade B
			A	B	C	D	E	F	G	H		
Pneumatic Height Adjustment												
Polypropylene	Standard	M271-1742	\$2367.26	\$2445.40	\$2527.22	\$2568.14	\$2604.08	\$2676.04	\$2741.74	\$2924.04	\$3050.50	\$3237.66
	Upholstered	M271-1842	2420.59	2498.73	2580.55	2621.47	2657.41	2729.37	2795.07	2977.37	3103.83	3290.99
	Soft Black Vinyl	M271-1942	2420.59	2498.73	2580.55	2621.47	2657.41	2729.37	2795.07	2977.37	3103.83	3290.99
Upholstered	Standard	M271-2742	\$2496.23	\$2574.37	\$2656.19	\$2697.11	\$2733.05	\$2805.01	\$2870.71	\$3053.01	\$3413.85	\$3601.01
	Upholstered	M271-2842	2549.56	2627.70	2709.52	2750.44	2786.38	2858.34	2924.04	3106.34	3467.18	3654.34
	Soft Black Vinyl	M271-2942	2549.56	2627.70	2709.52	2750.44	2786.38	2858.34	2924.04	3106.34	3467.18	3654.34
Pneumatic Height Adjustment/Back-Lock												
Polypropylene	Standard	M271-1741	\$2420.59	\$2498.73	\$2580.55	\$2621.47	\$2657.41	\$2729.37	\$2795.07	\$2977.37	\$3103.83	\$3290.99
	Upholstered	M271-1841	2473.92	2552.06	2633.88	2674.80	2710.74	2782.70	2848.40	3030.70	3157.16	3344.32
	Soft Black Vinyl	M271-1941	2473.92	2552.06	2633.88	2674.80	2710.74	2782.70	2848.40	3030.70	3157.16	3344.32
Upholstered	Standard	M271-2741	\$2549.56	\$2627.70	\$2709.52	\$2750.44	\$2786.38	\$2858.34	\$2924.04	\$3106.34	\$3467.18	\$3654.34
	Upholstered	M271-2841	2602.89	2681.03	2762.85	2803.77	2839.71	2911.67	2977.37	3159.67	3520.51	3707.67
	Soft Black Vinyl	M271-2941	2602.89	2681.03	2762.85	2803.77	2839.71	2911.67	2977.37	3159.67	3520.51	3707.67
Pneumatic Height Adjustment/Forward-Tilt												
Polypropylene	Standard	M281-1742	\$2419.34	\$2497.48	\$2579.30	\$2620.22	\$2656.16	\$2728.12	\$2793.82	\$2976.12	\$3102.58	\$3289.74
	Upholstered	M281-1842	2472.67	2550.81	2632.63	2673.55	2709.49	2781.45	2847.15	3029.45	3155.91	3343.07
	Soft Black Vinyl	M281-1942	2472.67	2550.81	2632.63	2673.55	2709.49	2781.45	2847.15	3029.45	3155.91	3343.07
Upholstered	Standard	M281-2742	\$2548.31	\$2626.45	\$2708.27	\$2749.19	\$2785.13	\$2857.09	\$2922.79	\$3105.09	\$3465.93	\$3653.09
	Upholstered	M281-2842	2601.64	2679.78	2761.60	2802.52	2838.46	2910.42	2976.12	3158.42	3519.26	3706.42
	Soft Black Vinyl	M281-2942	2601.64	2679.78	2761.60	2802.52	2838.46	2910.42	2976.12	3158.42	3519.26	3706.42

Improv Series

Improv H.E. XL Chair with Height Adjustable Task Arms

Shells	Arms/Caps	Number	Fabric Grade								Leather Grade A	Leather Grade B
			A	B	C	D	E	F	G	H		
Pneumatic Height Adjustment with Adjustable Air Lumbar												
Polypropylene	Standard	M271-1744	\$2496.23	\$2574.37	\$2656.19	\$2697.11	\$2733.05	\$2805.01	\$2870.71	\$3053.01	\$3179.47	\$3366.63
	Upholstered	M271-1844	2549.56	2627.70	2709.52	2750.44	2786.38	2858.34	2924.04	3106.34	3232.80	3419.96
	Soft Black Vinyl	M271-1944	2549.56	2627.70	2709.52	2750.44	2786.38	2858.34	2924.04	3106.34	3232.80	3419.96
Upholstered	Standard	M271-2744	\$2625.20	\$2703.34	\$2785.16	\$2826.08	\$2862.02	\$2933.98	\$2999.68	\$3181.98	\$3542.82	\$3729.98
	Upholstered	M271-2844	2678.53	2756.67	2838.49	2879.41	2915.35	2987.31	3053.01	3235.31	3596.15	3783.31
	Soft Black Vinyl	M271-2944	2678.53	2756.67	2838.49	2879.41	2915.35	2987.31	3053.01	3235.31	3596.15	3783.31
Pneumatic Height Adjustment/Back-Lock with Adjustable Air Lumbar												
Polypropylene	Standard	M271-1743	\$2549.56	\$2627.70	\$2709.52	\$2750.44	\$2786.38	\$2858.34	\$2924.04	\$3106.34	\$3232.80	\$3419.96
	Upholstered	M271-1843	2602.89	2681.03	2762.85	2803.77	2839.71	2911.67	2977.37	3159.67	3286.13	3473.29
	Soft Black Vinyl	M271-1943	2602.89	2681.03	2762.85	2803.77	2839.71	2911.67	2977.37	3159.67	3286.13	3473.29
Upholstered	Standard	M271-2743	\$2678.53	\$2756.67	\$2838.49	\$2879.41	\$2915.35	\$2987.31	\$3053.01	\$3235.31	\$3596.15	\$3783.31
	Upholstered	M271-2843	2731.86	2810.00	2891.82	2932.74	2968.68	3040.64	3106.34	3288.64	3649.48	3836.64
	Soft Black Vinyl	M271-2943	2731.86	2810.00	2891.82	2932.74	2968.68	3040.64	3106.34	3288.64	3649.48	3836.64
Pneumatic Height Adjustment/Forward-Tilt with Adjustable Air Lumbar												
Polypropylene	Standard	M281-1744	\$2548.31	\$2626.45	\$2708.27	\$2749.19	\$2785.13	\$2857.09	\$2922.79	\$3105.09	\$3231.55	\$3418.71
	Upholstered	M281-1844	2601.64	2679.78	2761.60	2802.52	2838.46	2910.42	2976.12	3158.42	3284.88	3472.04
	Soft Black Vinyl	M281-1944	2601.64	2679.78	2761.60	2802.52	2838.46	2910.42	2976.12	3158.42	3284.88	3472.04
Upholstered	Standard	M281-2744	\$2677.28	\$2755.42	\$2837.24	\$2878.16	\$2914.10	\$2986.06	\$3051.76	\$3234.06	\$3594.90	\$3782.06
	Upholstered	M281-2844	2730.61	2808.75	2890.57	2931.49	2967.43	3039.39	3105.09	3287.39	3648.23	3835.39
	Soft Black Vinyl	M281-2944	2730.61	2808.75	2890.57	2931.49	2967.43	3039.39	3105.09	3287.39	3648.23	3835.39

The following options require modification of the product number.

Faux Leather upholstery
Leather upholstery
Stain repellent

To specify, change the 2nd digit from a 2 to a 3; **Example:** M371-1842

To specify, change the 2nd digit from a 2 to a 1; **Example:** M171-1842

To specify, add -P to the end of the product number; **Example:** M271-1744-P (add \$39.68 list)

NOTE: For available fabrics, refer to surfaces.haworth.com.

Improv Series

Improv H.E. XL Chair with Flipper Arms



M271-1H42

Dimensions

SH: 16" - 20 1/2"
(406mm - 521mm)
H: 36 1/2" - 45"
(957mm - 1143mm)
D: 23 1/2" - 26 1/2"
(597mm - 673mm)
W: 30"(762mm)
SW: 23 3/4"(603mm)
SD: 16" - 19"
(406mm - 483mm)
AH: 6.2" - 11.1"
(157mm-282mm)

Features

- Accommodates up to 500 pounds.
- Outer Shells: Polypropylene or upholstered.
- Arms: Standard, upholstered fabric or black vinyl gel arm caps.
- Arm Adjustment Controls: Fingertip activation.
- Arm Adjustment: 5"(127mm) height adjustment.
- Arm Pad Rotation: 360°
- Casters: Standard with hard casters.
- Mechanism: Swivel with synchronized-tilt.
- Height Adjustment: Pneumatic.
- Optional Back-Lock: Lockable in two positions.
- Optional Forward Tilt: Lockable in 3 positions.
- Tilt tension.
- Optional Adjustable Air Lumbar additional 1 1/2"(38mm) of lumbar support.
- COM yardage / COL square footage:
Polypropylene shell: 2.41/51
Upholstered shell: 3.31/75

To Order, Specify:

- 1) Product number.
- 2) Fabric surface and color. (NOTE: For leather upholstery, see page 195.)
- 3) Trim color for shell, arms and base.

* All measurements taken with the BIFMA chair measuring device.

Shells	Arms/Caps	Number	Fabric Grade		C	D	E	F	G	H	Leather Grade A	Leather Grade B
			A	B								
Pneumatic Height Adjustment												
Polypropylene	Standard	M271-1H42	\$2595.43	\$2673.57	\$2755.39	\$2796.31	\$2832.25	\$2904.21	\$2969.91	\$3152.21	\$3278.67	\$3465.83
	Vinyl Gel	M271-1G42	2663.63	2741.77	2823.59	2864.51	2900.45	2972.41	3038.11	3220.41	3346.87	3534.03
	Upholstered	M271-1U42	2711.99	2790.13	2871.95	2912.87	2948.81	3020.77	3086.47	3268.77	3395.23	3582.39
Upholstered	Standard	M271-2H42	\$2724.40	\$2802.54	\$2884.36	\$2925.28	\$2961.22	\$3033.18	\$3098.88	\$3281.18	\$3642.02	\$3829.18
	Vinyl Gel	M271-2G42	2792.60	2870.74	2952.56	2993.48	3029.42	3101.38	3167.08	3349.38	3710.22	3897.38
	Upholstered	M271-2U42	2840.96	2919.10	3000.92	3041.84	3077.78	3149.74	3215.44	3397.74	3758.58	3945.74
Pneumatic Height Adjustment/Back-Lock												
Polypropylene	Standard	M271-1H41	\$2648.76	\$2726.90	\$2808.72	\$2849.64	\$2885.58	\$2957.54	\$3023.24	\$3205.54	\$3332.00	\$3519.16
	Vinyl Gel	M271-1G41	2716.96	2795.10	2876.92	2917.84	2953.78	3025.74	3091.44	3273.74	3400.20	3587.36
	Upholstered	M271-1U41	2765.32	2843.46	2925.28	2966.20	3002.14	3074.10	3139.80	3322.10	3448.56	3635.72
Upholstered	Standard	M271-2H41	\$2777.73	\$2855.87	\$2937.69	\$2978.61	\$3014.55	\$3086.51	\$3152.21	\$3334.51	\$3695.35	\$3882.51
	Vinyl Gel	M271-2G41	2845.93	2924.07	3005.89	3046.81	3082.75	3154.71	3220.41	3402.71	3763.55	3950.71
	Upholstered	M271-2U41	2894.29	2972.43	3054.25	3095.17	3131.11	3203.07	3268.77	3451.07	3811.91	3999.07
Pneumatic Height Adjustment/Forward-Tilt												
Polypropylene	Standard	M281-1H42	\$2647.51	\$2725.65	\$2807.47	\$2848.39	\$2884.33	\$2956.29	\$3021.99	\$3204.29	\$3330.75	\$3517.91
	Vinyl Gel	M281-1G42	2715.71	2793.85	2875.67	2916.59	2952.53	3024.49	3090.19	3272.49	3398.95	3586.11
	Upholstered	M281-1U42	2764.07	2842.21	2924.03	2964.95	3000.89	3072.85	3138.55	3320.85	3447.31	3634.47
Upholstered	Standard	M281-2H42	\$2776.48	\$2854.62	\$2936.44	\$2977.36	\$3013.30	\$3085.26	\$3150.96	\$3333.26	\$3694.10	\$3881.26
	Vinyl Gel	M281-2G42	2844.68	2922.82	3004.64	3045.56	3081.50	3153.46	3219.16	3401.46	3762.30	3949.46
	Upholstered	M281-2U42	2893.04	2971.18	3053.00	3093.92	3129.86	3201.82	3267.52	3449.82	3810.66	3997.82

Improv Series

Improv H.E. XL Chair with Flipper Arms

Shells	Arms/Caps	Number	Fabric Grade								Leather Grade A	Leather Grade B
			A	B	C	D	E	F	G	H		
Pneumatic Height Adjustment with Adjustable Air Lumbar												
Polypropylene	Standard	M271-1H44	\$2724.40	\$2802.54	\$2884.36	\$2925.28	\$2961.22	\$3033.18	\$3098.88	\$3281.18	\$3407.64	\$3594.80
	Vinyl Gel	M271-1G44	2792.60	2870.74	2952.56	2993.48	3029.42	3101.38	3167.08	3349.38	3475.84	3663.00
	Upholstered	M271-1U44	2840.96	2919.10	3000.92	3041.84	3077.78	3149.74	3215.44	3397.74	3524.20	3711.36
Upholstered	Standard	M271-2H44	\$2853.37	\$2931.51	\$3013.33	\$3054.25	\$3090.19	\$3162.15	\$3227.85	\$3410.15	\$3770.99	\$3958.15
	Vinyl Gel	M271-2G44	2921.57	2999.71	3081.53	3122.45	3158.39	3230.35	3296.05	3478.35	3839.19	4026.35
	Upholstered	M271-2U44	2969.93	3048.07	3129.89	3170.81	3206.75	3278.71	3344.41	3526.71	3887.55	4074.71
Pneumatic Height Adjustment/Back-Lock with Adjustable Air Lumbar												
Polypropylene	Standard	M271-1H43	\$2777.73	\$2855.87	\$2937.69	\$2978.61	\$3014.55	\$3086.51	\$3152.21	\$3334.51	\$3460.97	\$3648.13
	Vinyl Gel	M271-1G43	2845.93	2924.07	3005.89	3046.81	3082.75	3154.71	3220.41	3402.71	3529.17	3716.33
	Upholstered	M271-1U43	2894.29	2972.43	3054.25	3095.17	3131.11	3203.07	3268.77	3451.07	3577.53	3764.69
Upholstered	Standard	M271-2H43	\$2906.70	\$2984.84	\$3066.66	\$3107.58	\$3143.52	\$3215.48	\$3281.18	\$3463.48	\$3824.32	\$4011.48
	Vinyl Gel	M271-2G43	2974.90	3053.04	3134.86	3175.78	3211.72	3283.68	3349.38	3531.68	3892.52	4079.68
	Upholstered	M271-2U43	3023.26	3101.40	3183.22	3224.14	3260.08	3332.04	3397.74	3580.04	3940.88	4128.04
Pneumatic Height Adjustment/Forward-Tilt with Adjustable Air Lumbar												
Polypropylene	Standard	M281-1H44	\$2776.48	\$2854.62	\$2936.44	\$2977.36	\$3013.30	\$3085.26	\$3150.96	\$3333.26	\$3459.72	\$3646.88
	Vinyl Gel	M281-1G44	2844.68	2922.82	3004.64	3045.56	3081.50	3153.46	3219.16	3401.46	3527.92	3715.08
	Upholstered	M281-1U44	2893.04	2971.18	3053.00	3093.92	3129.86	3201.82	3267.52	3449.82	3576.28	3763.44
Upholstered	Standard	M281-2H44	\$2905.45	\$2983.59	\$3065.41	\$3106.33	\$3142.27	\$3214.23	\$3279.93	\$3462.23	\$3823.07	\$4010.23
	Vinyl Gel	M281-2G44	2973.65	3051.79	3133.61	3174.53	3210.47	3282.43	3348.13	3530.43	3891.27	4078.43
	Upholstered	M281-2U44	3022.01	3100.15	3181.97	3222.89	3258.83	3330.79	3396.49	3578.79	3939.63	4126.79

The following options require modification of the product number.

Faux Leather upholstery
Leather upholstery
Stain repellent

To specify, change the 2nd digit from a 2 to a 3; **Example:** M371-1H42

To specify, change the 2nd digit from a 2 to a 1; **Example:** M171-1H42

To specify, add -P to the end of the product number; **Example:** M271-1H44-P (add \$39.68 list)

NOTE: For available fabrics, refer to surfaces.haworth.com.

This page intentionally blank

Improv Series

Improv H.E. XL Chair without Arms



M271-1042

Dimensions

SH: 16" - 20 1/2"
(406mm - 521mm)
H: 36 1/2" - 45"
(957mm-1143mm)
D: 23 1/2" - 26 1/2"
(597mm - 673mm)
W: 30"(762mm)
SW: 23 3/4"(603mm)
SD: 16" - 19"
(406mm - 483mm)

Features

- Accommodates up to 500 pounds.
- Outer Shells: Polypropylene or upholstered.
- Casters: Standard with hard casters.
- Mechanism: Swivel with synchronized-tilt.
- Height Adjustment: Pneumatic.
- Optional Adjustable Air Lumbar models available: additional 1 1/2"(38mm) of lumbar support.
- Optional Back-Lock: Lockable in two positions.
- Optional Forward Tilt: Lockable in 3 positions.
- Tilt tension.
- Fire retardant construction is available to comply with California Bulletin #133, see below.
- COM yardage / COL square footage:
Polypropylene shell: 2.41/51
Upholstered shell: 3.31/75

To Order, Specify:

- 1) Product number.
- 2) Fabric surface and color.
(NOTE: For leather upholstery, see below.)
- 3) Trim color for shell and base.

* All measurements taken with the BIFMA chair measuring device.

Shells	Number	Fabric Grade		C	D	E	F	G	H	Leather Grade A	Leather Grade B
		A	B								
Pneumatic Height Adjustment											
Polypropylene	M271-1042	\$2151.49	\$2229.63	\$2311.45	\$2352.37	\$2388.31	\$2460.27	\$2525.97	\$2708.27	\$2834.73	\$3021.89
Upholstered	M271-2042	2280.46	2358.60	2440.42	2481.34	2517.28	2589.24	2654.94	2837.24	3198.08	3385.24
Pneumatic Height Adjustment/Back-Lock											
Polypropylene	M271-1041	\$2204.82	\$2282.96	\$2364.78	\$2405.70	\$2441.64	\$2513.60	\$2579.30	\$2761.60	\$2888.06	\$3075.22
Upholstered	M271-2041	2333.79	2411.93	2493.75	2534.67	2570.61	2642.57	2708.27	2890.57	3251.41	3438.57
Pneumatic Height Adjustment/Forward-Tilt											
Polypropylene	M281-1042	\$2203.57	\$2281.71	\$2363.53	\$2404.45	\$2440.39	\$2512.35	\$2578.05	\$2760.35	\$2886.81	\$3073.97
Upholstered	M281-2042	2332.54	2410.68	2492.50	2533.42	2569.36	2641.32	2707.02	2889.32	3250.16	3437.32
Pneumatic Height Adjustment with Adjustable Air Lumbar											
Polypropylene	M271-1044	\$2280.46	\$2358.60	\$2440.42	\$2481.34	\$2517.28	\$2589.24	\$2654.94	\$2837.24	\$2963.70	\$3150.86
Upholstered	M271-2044	2409.43	2487.57	2569.39	2610.31	2646.25	2718.21	2783.91	2966.21	3327.05	3514.21
Pneumatic Height Adjustment/Back-Lock with Adjustable Air Lumbar											
Polypropylene	M271-1043	\$2333.79	\$2411.93	\$2493.75	\$2534.67	\$2570.61	\$2642.57	\$2708.27	\$2890.57	\$3017.03	\$3204.19
Upholstered	M271-2043	2462.76	2540.90	2622.72	2663.64	2699.58	2771.54	2837.24	3019.54	3380.38	3567.54
Pneumatic Height Adjustment/Forward-Tilt with Adjustable Air Lumbar											
Polypropylene	M281-1044	\$2332.54	\$2410.68	\$2492.50	\$2533.42	\$2569.36	\$2641.32	\$2707.02	\$2889.32	\$3015.78	\$3202.94
Upholstered	M281-2044	2461.51	2539.65	2621.47	2662.39	2698.33	2770.29	2835.99	3018.29	3379.13	3566.29

The following options require modification of the product number.

Faux Leather upholstery
Leather upholstery
CAL 133
Stain repellent

To specify, change the 2nd digit from a 2 to a 3; **Example:** M371-2042
To specify, change the 2nd digit from a 2 to a 1; **Example:** M171-2042
To specify, add -F to the end of the product number; **Example:** M271-2042-F (add \$120.28 list)
To specify, add -P to the end of the product number; **Example:** M271-1042-P (add \$39.68 list)

NOTE: For available fabrics, refer to surfaces.haworth.com.

Improv Series

Improv H.E. High-Back Chair with Task Arms



M251-1442

Dimensions

SH: 16" - 21"
(406mm-533mm)
H: 36 1/2" - 45"
(957mm - 1143mm)
D: 24" - 27 1/4"
(610mm - 692mm)
W: 25"(635mm)
SW: 19.2"(488mm)
SD: 16" - 19"
(406mm - 483mm)
AH: 9.6"(244mm)

Two-stage seat height:
.7"(18mm) below
standard
1.9"(48mm) above
standard

Features

- Outer Shells: Polypropylene or upholstered.
- Arms: Standard, upholstered fabric or soft black vinyl arm caps.
- 3"(76mm) sliding seat pan.
- Casters: Standard with hard casters; or optional soft casters.
- Standard plastic base or optional high arc, or steel base.
- Mechanism: Swivel with synchronized-tilt.
- Height Adjustment: Pneumatic, pneumatic with two-stage seat height, or pneumatic with low-position seat height option.
- Optional Back-Lock: Lockable in two positions.
- Optional Forward Tilt: Lockable in 3 positions.
- Tilt tension.
- Optional Adjustable Air Lumbar: additional 1 1/2"(38mm) of lumbar support.
- Fire retardant construction is available to comply with California Bulletin #133.
- COM yardage / COL square footage:
Polypropylene shell: 2.13/45
Upholstered shell: 2.75/62

To Order, Specify:

- 1) Product number.
- 2) Fabric surface and color.
(NOTE: For leather upholstery, see page 199.)
- 3) Trim color for shell, arms and base.

* All measurements taken with the BIFMA chair measuring device.

Shells	Arms/Caps	Number	Fabric Grade		C	D	E	F	G	H	Leather Grade A	Leather Grade B
			A	B								
Pneumatic Height Adjustment												
Polypropylene	Standard	M251-1442	\$1130.93	\$1209.07	\$1290.89	\$1331.81	\$1367.75	\$1439.71	\$1505.41	\$1687.71	\$1814.17	\$2001.33
	Upholstered	M251-1542	1184.26	1262.40	1344.22	1385.14	1421.08	1493.04	1558.74	1741.04	1867.50	2054.66
	Soft Black Vinyl	M251-1642	1184.26	1262.40	1344.22	1385.14	1421.08	1493.04	1558.74	1741.04	1867.50	2054.66
Upholstered	Standard	M251-2442	\$1259.90	\$1338.04	\$1419.86	\$1460.78	\$1496.72	\$1568.68	\$1634.38	\$1816.68	\$2177.52	\$2364.68
	Upholstered	M251-2542	1313.23	1391.37	1473.19	1514.11	1550.05	1622.01	1687.71	1870.01	2230.85	2418.01
	Soft Black Vinyl	M251-2642	1313.23	1391.37	1473.19	1514.11	1550.05	1622.01	1687.71	1870.01	2230.85	2418.01
Pneumatic Height Adjustment/Back-Lock												
Polypropylene	Standard	M251-1441	\$1184.26	\$1262.40	\$1344.22	\$1385.14	\$1421.08	\$1493.04	\$1558.74	\$1741.04	\$1867.50	\$2054.66
	Upholstered	M251-1541	1237.59	1315.73	1397.55	1438.47	1474.41	1546.37	1612.07	1794.37	1920.83	2107.99
	Soft Black Vinyl	M251-1641	1237.59	1315.73	1397.55	1438.47	1474.41	1546.37	1612.07	1794.37	1920.83	2107.99
Upholstered	Standard	M251-2441	\$1313.23	\$1391.37	\$1473.19	\$1514.11	\$1550.05	\$1622.01	\$1687.71	\$1870.01	\$2230.85	\$2418.01
	Upholstered	M251-2541	1366.56	1444.70	1526.52	1567.44	1603.38	1675.34	1741.04	1923.34	2284.18	2471.34
	Soft Black Vinyl	M251-2641	1366.56	1444.70	1526.52	1567.44	1603.38	1675.34	1741.04	1923.34	2284.18	2471.34
Pneumatic Height Adjustment/Forward-Tilt												
Polypropylene	Standard	M261-1442	\$1183.01	\$1261.15	\$1342.97	\$1383.89	\$1419.83	\$1491.79	\$1557.49	\$1739.79	\$1866.25	\$2053.41
	Upholstered	M261-1542	1236.34	1314.48	1396.30	1437.22	1473.16	1545.12	1610.82	1793.12	1919.58	2106.74
	Soft Black Vinyl	M261-1642	1236.34	1314.48	1396.30	1437.22	1473.16	1545.12	1610.82	1793.12	1919.58	2106.74
Upholstered	Standard	M261-2442	\$1311.98	\$1390.12	\$1471.94	\$1512.86	\$1548.80	\$1620.76	\$1686.46	\$1868.76	\$2229.60	\$2416.76
	Upholstered	M261-2542	1365.31	1443.45	1525.27	1566.19	1602.13	1674.09	1739.79	1922.09	2282.93	2470.09
	Soft Black Vinyl	M261-2642	1365.31	1443.45	1525.27	1566.19	1602.13	1674.09	1739.79	1922.09	2282.93	2470.09

Improv Series

Improv H.E. High-Back Chair with Task Arms

Shells	Arms/Caps	Number	Fabric Grade								Leather Grade A	Leather Grade B
			A	B	C	D	E	F	G	H		
Pneumatic Height Adjustment with Adjustable Air Lumbar												
Polypropylene	Standard	M251-1444	\$1259.90	\$1338.04	\$1419.86	\$1460.78	\$1496.72	\$1568.68	\$1634.38	\$1816.68	\$1943.14	\$2130.30
	Upholstered	M251-1544	1313.23	1391.37	1473.19	1514.11	1550.05	1622.01	1687.71	1870.01	1996.47	2183.63
	Soft Black Vinyl	M251-1644	1313.23	1391.37	1473.19	1514.11	1550.05	1622.01	1687.71	1870.01	1996.47	2183.63
Upholstered	Standard	M251-2444	\$1388.87	\$1467.01	\$1548.83	\$1589.75	\$1625.69	\$1697.65	\$1763.35	\$1945.65	\$2306.49	\$2493.65
	Upholstered	M251-2544	1442.20	1520.34	1602.16	1643.08	1679.02	1750.98	1816.68	1998.98	2359.82	2546.98
	Soft Black Vinyl	M251-2644	1442.20	1520.34	1602.16	1643.08	1679.02	1750.98	1816.68	1998.98	2359.82	2546.98
Pneumatic Height Adjustment/Back-Lock with Adjustable Air Lumbar												
Polypropylene	Standard	M251-1443	\$1313.23	\$1391.37	\$1473.19	\$1514.11	\$1550.05	\$1622.01	\$1687.71	\$1870.01	\$1996.47	\$2183.63
	Upholstered	M251-1543	1366.56	1444.70	1526.52	1567.44	1603.38	1675.34	1741.04	1923.34	2049.80	2236.96
	Soft Black Vinyl	M251-1643	1366.56	1444.70	1526.52	1567.44	1603.38	1675.34	1741.04	1923.34	2049.80	2236.96
Upholstered	Standard	M251-2443	\$1442.20	\$1520.34	\$1602.16	\$1643.08	\$1679.02	\$1750.98	\$1816.68	\$1998.98	\$2359.82	\$2546.98
	Upholstered	M251-2543	1495.53	1573.67	1655.49	1696.41	1732.35	1804.31	1870.01	2052.31	2413.15	2600.31
	Soft Black Vinyl	M251-2643	1495.53	1573.67	1655.49	1696.41	1732.35	1804.31	1870.01	2052.31	2413.15	2600.31
Pneumatic Height Adjustment/Forward-Tilt with Adjustable Air Lumbar												
Polypropylene	Standard	M261-1444	\$1311.98	\$1390.12	\$1471.94	\$1512.86	\$1548.80	\$1620.76	\$1686.46	\$1868.76	\$1995.22	\$2182.38
	Upholstered	M261-1544	1365.31	1443.45	1525.27	1566.19	1602.13	1674.09	1739.79	1922.09	2048.55	2235.71
	Soft Black Vinyl	M261-1644	1365.31	1443.45	1525.27	1566.19	1602.13	1674.09	1739.79	1922.09	2048.55	2235.71
Upholstered	Standard	M261-2444	\$1440.95	\$1519.09	\$1600.91	\$1641.83	\$1677.77	\$1749.73	\$1815.43	\$1997.73	\$2358.57	\$2545.73
	Upholstered	M261-2544	1494.28	1572.42	1654.24	1695.16	1731.10	1803.06	1868.76	2051.06	2411.90	2599.06
	Soft Black Vinyl	M261-2644	1494.28	1572.42	1654.24	1695.16	1731.10	1803.06	1868.76	2051.06	2411.90	2599.06

The following options require modification of the product number.

Two-stage seat height	To specify, change the 4th digit from a 1 to a 3; Example: M253-1442 (add \$102.93 list)
High arc base	To specify, change the 4th digit from a 1 to a 5; Example: M255-1442
Steel base - Standard height	To specify, change the 4th digit from a 1 to a 6; Example: M256-1442
Steel base - Low height	To specify, change the 4th digit from a 1 to a 7; Example: M257-1442
Plastic base - Low height	To specify, change the 4th digit from a 1 to a 4; Example: M254-1442
Soft casters	To specify, change the 7th digit from a 4 to a 2; Example: M251-1422
Faux Leather upholstery	To specify, change the 2nd digit from a 2 to a 3; Example: M351-1442
Leather upholstery	To specify, change the 2nd digit from a 2 to a 1; Example: M151-1442
CAL 133	To specify, add -F to the end of the product number; Example: M251-2542-F (add \$120.28 list)
Stain repellent	To specify, add -P to the end of the product number; Example: M251-1444-P (add \$39.68 list)

NOTE: CAL 133 is available on all fully upholstered models and chairs with black (TR-F) polypropylene shells backs.

High arc base available in black only.

For available fabrics, refer to surfaces.haworth.com.

Improv Series

Improv H.E. High-Back Chair with Height Adjustable Task Arms



M251-1742

Dimensions

SH: 16" - 21"
(406mm - 533mm)
H: 36 1/2" - 45"
(957mm - 1143mm)
D: 24" - 27 1/4"
(610mm - 692mm)
W: 25"(635mm)
SW: 19.2"(488mm)
SD: 16" - 19"
(406mm - 483mm)
AH: 6.9" - 10.8"
(175mm - 274mm)

Two-stage seat height:
.7"(18mm) below
standard
1.9"(48mm) above
standard

Features

- Outer Shells: Polypropylene or upholstered.
- Arms: Standard, upholstered fabric or soft black vinyl arm caps.
- Arm Adjustment Controls: Fingertip activation.
- Arm Adjustment: 4"(102mm) height adjustment.
- 3"(76mm) sliding seat pan.
- Casters: Standard with hard casters; or optional soft casters.
- Standard plastic base or optional high arc, or steel base.
- Mechanism: Swivel with synchronized-tilt.
- Height Adjustment: Pneumatic, pneumatic with two-stage seat height, or pneumatic with low-position seat height option.
- Optional Back-Lock: Lockable in two positions.
- Optional Forward Tilt: Lockable in 3 positions.
- Tilt tension.
- Optional Adjustable Air Lumbar: additional 1 1/2"(38mm) of lumbar support.
- COM yardage / COL square footage:
Polypropylene shell: 2.13/45
Upholstered shell: 2.75/62

To Order, Specify:

- 1) Product number.
- 2) Fabric surface and color.
(NOTE: For leather upholstery, see page 201.)
- 3) Trim color for shell, arms and base.

* All measurements taken with the BIFMA chair measuring device.

Shells	Arms/Caps	Number	Fabric Grade		C	D	E	F	G	H	Leather Grade A	Leather Grade B
			A	B								
Pneumatic Height Adjustment												
Polypropylene	Standard	M251-1742	\$1242.53	\$1320.67	\$1402.49	\$1443.41	\$1479.35	\$1551.31	\$1617.01	\$1799.31	\$1925.77	\$2112.93
	Upholstered	M251-1842	1295.86	1374.00	1455.82	1496.74	1532.68	1604.64	1670.34	1852.64	1979.10	2166.26
	Soft Black Vinyl	M251-1942	1295.86	1374.00	1455.82	1496.74	1532.68	1604.64	1670.34	1852.64	1979.10	2166.26
Upholstered	Standard	M251-2742	\$1371.50	\$1449.64	\$1531.46	\$1572.38	\$1608.32	\$1680.28	\$1745.98	\$1928.28	\$2289.12	\$2476.28
	Upholstered	M251-2842	1424.83	1502.97	1584.79	1625.71	1661.65	1733.61	1799.31	1981.61	2342.45	2529.61
	Soft Black Vinyl	M251-2942	1424.83	1502.97	1584.79	1625.71	1661.65	1733.61	1799.31	1981.61	2342.45	2529.61
Pneumatic Height Adjustment/Back-Lock												
Polypropylene	Standard	M251-1741	\$1295.86	\$1374.00	\$1455.82	\$1496.74	\$1532.68	\$1604.64	\$1670.34	\$1852.64	\$1979.10	\$2166.26
	Upholstered	M251-1841	1349.19	1427.33	1509.15	1550.07	1586.01	1657.97	1723.67	1905.97	2032.43	2219.59
	Soft Black Vinyl	M251-1941	1349.19	1427.33	1509.15	1550.07	1586.01	1657.97	1723.67	1905.97	2032.43	2219.59
Upholstered	Standard	M251-2741	\$1424.83	\$1502.97	\$1584.79	\$1625.71	\$1661.65	\$1733.61	\$1799.31	\$1981.61	\$2342.45	\$2529.61
	Upholstered	M251-2841	1478.16	1556.30	1638.12	1679.04	1714.98	1786.94	1852.64	2034.94	2395.78	2582.94
	Soft Black Vinyl	M251-2941	1478.16	1556.30	1638.12	1679.04	1714.98	1786.94	1852.64	2034.94	2395.78	2582.94
Pneumatic Height Adjustment/Forward-Tilt												
Polypropylene	Standard	M261-1742	\$1294.61	\$1372.75	\$1454.57	\$1495.49	\$1531.43	\$1603.39	\$1669.09	\$1851.39	\$1977.85	\$2165.01
	Upholstered	M261-1842	1347.94	1426.08	1507.90	1548.82	1584.76	1656.72	1722.42	1904.72	2031.18	2218.34
	Soft Black Vinyl	M261-1942	1347.94	1426.08	1507.90	1548.82	1584.76	1656.72	1722.42	1904.72	2031.18	2218.34
Upholstered	Standard	M261-2742	\$1423.58	\$1501.72	\$1583.54	\$1624.46	\$1660.40	\$1732.36	\$1798.06	\$1980.36	\$2341.20	\$2528.36
	Upholstered	M261-2842	1476.91	1555.05	1636.87	1677.79	1713.73	1785.69	1851.39	2033.69	2394.53	2581.69
	Soft Black Vinyl	M261-2942	1476.91	1555.05	1636.87	1677.79	1713.73	1785.69	1851.39	2033.69	2394.53	2581.69

Improv Series

Improv H.E. High-Back Chair with Height Adjustable Task Arms

Shells	Arms/Caps	Number	Fabric Grade								Leather Grade A	Leather Grade B
			A	B	C	D	E	F	G	H		
Pneumatic Height Adjustment with Adjustable Air Lumbar												
Polypropylene	Standard	M251-1744	\$1371.50	\$1449.64	\$1531.46	\$1572.38	\$1608.32	\$1680.28	\$1745.98	\$1928.28	\$2054.74	\$2241.90
	Upholstered	M251-1844	1424.83	1502.97	1584.79	1625.71	1661.65	1733.61	1799.31	1981.61	2108.07	2295.23
	Soft Black Vinyl	M251-1944	1424.83	1502.97	1584.79	1625.71	1661.65	1733.61	1799.31	1981.61	2108.07	2295.23
Upholstered	Standard	M251-2744	\$1500.47	\$1578.61	\$1660.43	\$1701.35	\$1737.29	\$1809.25	\$1874.95	\$2057.25	\$2418.09	\$2605.25
	Upholstered	M251-2844	1553.80	1631.94	1713.76	1754.68	1790.62	1862.58	1928.28	2110.58	2471.42	2658.58
	Soft Black Vinyl	M251-2944	1553.80	1631.94	1713.76	1754.68	1790.62	1862.58	1928.28	2110.58	2471.42	2658.58
Pneumatic Height Adjustment/Back-Lock with Adjustable Air Lumbar												
Polypropylene	Standard	M251-1743	\$1424.83	\$1502.97	\$1584.79	\$1625.71	\$1661.65	\$1733.61	\$1799.31	\$1981.61	\$2108.07	\$2295.23
	Upholstered	M251-1843	1478.16	1556.30	1638.12	1679.04	1714.98	1786.94	1852.64	2034.94	2161.40	2348.56
	Soft Black Vinyl	M251-1943	1478.16	1556.30	1638.12	1679.04	1714.98	1786.94	1852.64	2034.94	2161.40	2348.56
Upholstered	Standard	M251-2743	\$1553.80	\$1631.94	\$1713.76	\$1754.68	\$1790.62	\$1862.58	\$1928.28	\$2110.58	\$2471.42	\$2658.58
	Upholstered	M251-2843	1607.13	1685.27	1767.09	1808.01	1843.95	1915.91	1981.61	2163.91	2524.75	2711.91
	Soft Black Vinyl	M251-2943	1607.13	1685.27	1767.09	1808.01	1843.95	1915.91	1981.61	2163.91	2524.75	2711.91
Pneumatic Height Adjustment/Forward-Tilt with Adjustable Air Lumbar												
Polypropylene	Standard	M261-1744	\$1423.58	\$1501.72	\$1583.54	\$1624.46	\$1660.40	\$1732.36	\$1798.06	\$1980.36	\$2106.82	\$2293.98
	Upholstered	M261-1844	1476.91	1555.05	1636.87	1677.79	1713.73	1785.69	1851.39	2033.69	2160.15	2347.31
	Soft Black Vinyl	M261-1944	1476.91	1555.05	1636.87	1677.79	1713.73	1785.69	1851.39	2033.69	2160.15	2347.31
Upholstered	Standard	M261-2744	\$1552.55	\$1630.69	\$1712.51	\$1753.43	\$1789.37	\$1861.33	\$1927.03	\$2109.33	\$2470.17	\$2657.33
	Upholstered	M261-2844	1605.88	1684.02	1765.84	1806.76	1842.70	1914.66	1980.36	2162.66	2523.50	2710.66
	Soft Black Vinyl	M261-2944	1605.88	1684.02	1765.84	1806.76	1842.70	1914.66	1980.36	2162.66	2523.50	2710.66

The following options require modification of the product number.

Two-stage seat height	To specify, change the 4th digit from a 1 to a 3; Example: M253-1742 (add \$102.93 list)
High arc base	To specify, change the 4th digit from a 1 to a 5; Example: M255-1742
Steel base - Standard height	To specify, change the 4th digit from a 1 to a 6; Example: M256-1742
Steel base - Low height	To specify, change the 4th digit from a 1 to a 7; Example: M257-1742
Plastic base - Low height	To specify, change the 4th digit from a 1 to a 4; Example: M254-1742
Soft casters	To specify, change the 7th digit from a 4 to a 2; Example: M251-1722
Faux Leather upholstery	To specify, change the 2nd digit from a 2 to a 3; Example: M351-1742
Leather upholstery	To specify, change the 2nd digit from a 2 to a 1; Example: M151-1742
Stain repellent	To specify, add -P to the end of the product number; Example: M251-1744-P (add \$39.68 list)

NOTE: High arc base available in black only.

For available fabrics, refer to surfaces.haworth.com.

Improv Series

Improv H.E. High-Back Chair with Flipper Arms



M251-1H42

NOTE:
M261-1G42 offers the best value package of options for this model.

Dimensions

SH: 16" - 21"
(406mm - 533mm)
H: 36 1/2" - 45"
(957mm-1143mm)
D: 24" - 27 1/4"
(610mm - 692mm)
W: 26 1/2"(673mm)
SW: 19.2"(488mm)
SD: 16" - 19"
(406mm - 483mm)
AH: 6.2" - 11.3"
(157mm-287mm)

Two-stage seat height:
.7"(18mm) below
standard
1.9"(48mm) above
standard

Features

- Outer Shells: Polypropylene or upholstered.
- Arms: Standard, upholstered fabric or black vinyl gel arm caps.
- Arm Adjustment Controls: Fingertip activation.
- Arm Adjustment: 5"(127mm) height adjustment.
- Arm Pad Rotation: 360°.
- 3"(76mm) sliding seat pan.
- Casters: Standard with hard casters; for optional soft casters.
- Standard plastic base or optional high arc, or steel base.
- Mechanism: Swivel with synchronized-tilt.
- Height Adjustment: Pneumatic, pneumatic with two-stage seat height, or pneumatic with low-position seat height option.
- Optional Back-Lock: Lockable in two positions.
- Optional Forward Tilt: Lockable in 3 positions.
- Tilt tension.
- Optional Adjustable Air Lumbar: additional 1 1/2"(38mm) of lumbar support.
- COM yardage / COL square footage:
Polypropylene shell: 2.13/45
Upholstered shell: 2.75/62

To Order, Specify:

- 1) Product number.
- 2) Fabric surface and color.
(NOTE: For leather upholstery, see page 203.)
- 3) Trim color for shell, arms and base.

* All measurements taken with the BIFMA chair measuring device.

Shells	Arms/Caps	Number	Fabric Grade		C	D	E	F	G	H	Leather Grade A	Leather Grade B
			A	B								
Pneumatic Height Adjustment												
Polypropylene	Standard	M251-1H42	\$1470.70	\$1548.84	\$1630.66	\$1671.58	\$1707.52	\$1779.48	\$1845.18	\$2027.48	\$2153.94	\$2341.10
	Vinyl Gel	M251-1G42	1538.90	1617.04	1698.86	1739.78	1775.72	1847.68	1913.38	2095.68	2222.14	2409.30
	Upholstered	M251-1U42	1587.26	1665.40	1747.22	1788.14	1824.08	1896.04	1961.74	2144.04	2270.50	2457.66
Upholstered	Standard	M251-2H42	\$1599.67	\$1677.81	\$1759.63	\$1800.55	\$1836.49	\$1908.45	\$1974.15	\$2156.45	\$2517.29	\$2704.45
	Vinyl Gel	M251-2G42	1667.87	1746.01	1827.83	1868.75	1904.69	1976.65	2042.35	2224.65	2585.49	2772.65
	Upholstered	M251-2U42	1716.23	1794.37	1876.19	1917.11	1953.05	2025.01	2090.71	2273.01	2633.85	2821.01
Pneumatic Height Adjustment/Back-Lock												
Polypropylene	Standard	M251-1H41	\$1524.03	\$1602.17	\$1683.99	\$1724.91	\$1760.85	\$1832.81	\$1898.51	\$2080.81	\$2207.27	\$2394.43
	Vinyl Gel	M251-1G41	1592.23	1670.37	1752.19	1793.11	1829.05	1901.01	1966.71	2149.01	2275.47	2462.63
	Upholstered	M251-1U41	1640.59	1718.73	1800.55	1841.47	1877.41	1949.37	2015.07	2197.37	2323.83	2510.99
Upholstered	Standard	M251-2H41	\$1653.00	\$1731.14	\$1812.96	\$1853.88	\$1889.82	\$1961.78	\$2027.48	\$2209.78	\$2570.62	\$2757.78
	Vinyl Gel	M251-2G41	1721.20	1799.34	1881.16	1922.08	1958.02	2029.98	2095.68	2277.98	2638.82	2825.98
	Upholstered	M251-2U41	1769.56	1847.70	1929.52	1970.44	2006.38	2078.34	2144.04	2326.34	2687.18	2874.34
Pneumatic Height Adjustment/Forward-Tilt												
Polypropylene	Standard	M261-1H42	\$1522.78	\$1600.92	\$1682.74	\$1723.66	\$1759.60	\$1831.56	\$1897.26	\$2079.56	\$2206.02	\$2393.18
	Vinyl Gel	M261-1G42	1590.98	1669.12	1750.94	1791.86	1827.80	1899.76	1965.46	2147.76	2274.22	2461.38
	Upholstered	M261-1U42	1639.34	1717.48	1799.30	1840.22	1876.16	1948.12	2013.82	2196.12	2322.58	2509.74
Upholstered	Standard	M261-2H42	\$1651.75	\$1729.89	\$1811.71	\$1852.63	\$1888.57	\$1960.53	\$2026.23	\$2208.53	\$2569.37	\$2756.53
	Vinyl Gel	M261-2G42	1719.95	1798.09	1879.91	1920.83	1956.77	2028.73	2094.43	2276.73	2637.57	2824.73
	Upholstered	M261-2U42	1768.31	1846.45	1928.27	1969.19	2005.13	2077.09	2142.79	2325.09	2685.93	2873.09

Improv Series

Improv H.E. High-Back Chair with Flipper Arms

Shells	Arms/Caps	Number	Fabric Grade								Leather Grade A	Leather Grade B
			A	B	C	D	E	F	G	H		
Pneumatic Height Adjustment with Adjustable Air Lumbar												
Polypropylene	Standard	M251-1H44	\$1599.67	\$1677.81	\$1759.63	\$1800.55	\$1836.49	\$1908.45	\$1974.15	\$2156.45	\$2282.91	\$2470.07
	Vinyl Gel	M251-1G44	1667.87	1746.01	1827.83	1868.75	1904.69	1976.65	2042.35	2224.65	2351.11	2538.27
	Upholstered	M251-1U44	1716.23	1794.37	1876.19	1917.11	1953.05	2025.01	2090.71	2273.01	2399.47	2586.63
Upholstered	Standard	M251-2H44	\$1728.64	\$1806.78	\$1888.60	\$1929.52	\$1965.46	\$2037.42	\$2103.12	\$2285.42	\$2646.26	\$2833.42
	Vinyl Gel	M251-2G44	1796.84	1874.98	1956.80	1997.72	2033.66	2105.62	2171.32	2353.62	2714.46	2901.62
	Upholstered	M251-2U44	1845.20	1923.34	2005.16	2046.08	2082.02	2153.98	2219.68	2401.98	2762.82	2949.98
Pneumatic Height Adjustment/Back-Lock with Adjustable Air Lumbar												
Polypropylene	Standard	M251-1H43	\$1653.00	\$1731.14	\$1812.96	\$1853.88	\$1889.82	\$1961.78	\$2027.48	\$2209.78	\$2336.24	\$2523.40
	Vinyl Gel	M251-1G43	1721.20	1799.34	1881.16	1922.08	1958.02	2029.98	2095.68	2277.98	2404.44	2591.60
	Upholstered	M251-1U43	1769.56	1847.70	1929.52	1970.44	2006.38	2078.34	2144.04	2326.34	2452.80	2639.96
Upholstered	Standard	M251-2H43	\$1781.97	\$1860.11	\$1941.93	\$1982.85	\$2018.79	\$2090.75	\$2156.45	\$2338.75	\$2699.59	\$2886.75
	Vinyl Gel	M251-2G43	1850.17	1928.31	2010.13	2051.05	2086.99	2158.95	2224.65	2406.95	2767.79	2954.95
	Upholstered	M251-2U43	1898.53	1976.67	2058.49	2099.41	2135.35	2207.31	2273.01	2455.31	2816.15	3003.31
Pneumatic Height Adjustment/Forward-Tilt with Adjustable Air Lumbar												
Polypropylene	Standard	M261-1H44	\$1651.75	\$1729.89	\$1811.71	\$1852.63	\$1888.57	\$1960.53	\$2026.23	\$2208.53	\$2334.99	\$2522.15
	Vinyl Gel	M261-1G44	1719.95	1798.09	1879.91	1920.83	1956.77	2028.73	2094.43	2276.73	2403.19	2590.35
	Upholstered	M261-1U44	1768.31	1846.45	1928.27	1969.19	2005.13	2077.09	2142.79	2325.09	2451.55	2638.71
Upholstered	Standard	M261-2H44	\$1780.72	\$1858.86	\$1940.68	\$1981.60	\$2017.54	\$2089.50	\$2155.20	\$2337.50	\$2698.34	\$2885.50
	Vinyl Gel	M261-2G44	1848.92	1927.06	2008.88	2049.80	2085.74	2157.70	2223.40	2405.70	2766.54	2953.70
	Upholstered	M261-2U44	1897.28	1975.42	2057.24	2098.16	2134.10	2206.06	2271.76	2454.06	2814.90	3002.06

The following options require modification of the product number.

Two-stage seat height	To specify, change the 4th digit from a 1 to a 3; Example: M253-1H42 (add \$102.93 list)
High arc base	To specify, change the 4th digit from a 1 to a 5; Example: M255-1H42
Steel base - Standard height	To specify, change the 4th digit from a 1 to a 6; Example: M256-1H42
Steel base - Low height	To specify, change the 4th digit from a 1 to a 7; Example: M257-1H42
Plastic base - Low height	To specify, change the 4th digit from a 1 to a 4; Example: M254-1H42
Soft casters	To specify, change the 7th digit from a 4 to a 2; Example: M251-1H22
Faux Leather upholstery	To specify, change the 2nd digit from a 2 to a 3; Example: M351-1H42
Leather upholstery	To specify, change the 2nd digit from a 2 to a 1; Example: M151-1H42
Stain repellent	To specify, add -P to the end of the product number; Example: M251-1H44-P (add \$39.68 list)

NOTE: High arc base available in black only.

For available fabrics, refer to surfaces.haworth.com.

Improv Series

Improv H.E. High-Back Chair with Height and Width Adjustable 3-D Arms



M251-1W42

Dimensions

SH: 16" - 21"
(406mm - 533mm)
H: 36 1/2" - 45"
(957mm - 1143mm)
D: 24" - 27 1/4"
(610mm - 692mm)
W: 25"(635mm)
SW: 19.2"(488mm)
SD: 16" - 19"
(406mm - 483mm)
AH: 3 3/4" - 7 3/4"
(95mm-197mm)
AW: 25 1/2" - 29 1/4"
(647mm-743mm)

Two-stage seat height:
.7"(18mm) below
standard
1.9"(48mm) above
standard

Features

- Outer Shells: Polypropylene or upholstered.
- Arms: Molded black vinyl.
- 3"(76mm) sliding seat pan.
- Casters: Standard with hard casters; or optional soft casters, see below.
- Standard plastic base or optional high arc, or steel base.
- Mechanism: Swivel with synchronized-tilt.
- Height Adjustment: Pneumatic, pneumatic with two-stage seat height, or pneumatic with low-position seat height option.
- Arm Adjustment: 4"(102mm) height adjustment.
- Arm Width Adjustment: 1 1/2"(38mm) per arm in-out adjustment.
- Arm Pad Rotation: 360°.
- Arm Adjustment Controls: Fingertip activation.
- Optional Back-Lock: Lockable in two positions.
- Optional Forward Tilt: Lockable in 3 positions.
- Tilt tension.
- Optional Adjustable Air Lumbar: additional 1 1/2"(38mm) of lumbar support.
- COM yardage / COL square footage:
Polypropylene shell: 2.13/45
Upholstered shell: 2.75/62

To Order, Specify:

- 1) Product number.
- 2) Fabric surface and color.
(NOTE: For leather upholstery, see below.)
- 3) Trim color for shell, arms and base.

* All measurements taken with the BIFMA chair measuring device.

Shells	Arms/Caps	Number	Fabric Grade								Leather Grade A	Leather Grade B
			A	B	C	D	E	F	G	H		
Pneumatic Height Adjustment												
Polypropylene	Molded Black Vinyl	M251-1W42	\$1380.17	\$1458.31	\$1540.13	\$1581.05	\$1616.99	\$1688.95	\$1754.65	\$1936.95	\$2063.41	\$2250.57
Upholstered	Molded Black Vinyl	M251-2W42	1509.14	1587.28	1669.10	1710.02	1745.96	1817.92	1883.62	2065.92	2426.76	2613.92
Pneumatic Height Adjustment/Back-Lock												
Polypropylene	Molded Black Vinyl	M251-1W41	\$1433.50	\$1511.64	\$1593.46	\$1634.38	\$1670.32	\$1742.28	\$1807.98	\$1990.28	\$2116.74	\$2303.90
Upholstered	Molded Black Vinyl	M251-2W41	1562.47	1640.61	1722.43	1763.35	1799.29	1871.25	1936.95	2119.25	2480.09	2667.25
Pneumatic Height Adjustment/Forward-Tilt												
Polypropylene	Molded Black Vinyl	M261-1W42	\$1432.25	\$1510.39	\$1592.21	\$1633.13	\$1669.07	\$1741.03	\$1806.73	\$1989.03	\$2115.49	\$2302.65
Upholstered	Molded Black Vinyl	M261-2W42	1561.22	1639.36	1721.18	1762.10	1798.04	1870.00	1935.70	2118.00	2478.84	2666.00
Pneumatic Height Adjustment with Adjustable Air Lumbar												
Polypropylene	Molded Black Vinyl	M251-1W44	\$1509.14	\$1587.28	\$1669.10	\$1710.02	\$1745.96	\$1817.92	\$1883.62	\$2065.92	\$2192.38	\$2379.54
Upholstered	Molded Black Vinyl	M251-2W44	1638.11	1716.25	1798.07	1838.99	1874.93	1946.89	2012.59	2194.89	2555.73	2742.89
Pneumatic Height Adjustment/Back-Lock with Adjustable Air Lumbar												
Polypropylene	Molded Black Vinyl	M251-1W43	\$1562.47	\$1640.61	\$1722.43	\$1763.35	\$1799.29	\$1871.25	\$1936.95	\$2119.25	\$2245.71	\$2432.87
Upholstered	Molded Black Vinyl	M251-2W43	1691.44	1769.58	1851.40	1892.32	1928.26	2000.22	2065.92	2248.22	2609.06	2796.22
Pneumatic Height Adjustment/Forward-Tilt with Adjustable Air Lumbar												
Polypropylene	Molded Black Vinyl	M261-1W44	\$1561.22	\$1639.36	\$1721.18	\$1762.10	\$1798.04	\$1870.00	\$1935.70	\$2118.00	\$2244.46	\$2431.62
Upholstered	Molded Black Vinyl	M261-2W44	1690.19	1768.33	1850.15	1891.07	1927.01	1998.97	2064.67	2246.97	2607.81	2794.97

The following options require modification of the product number.

- Two-stage seat height
- High arc base
- Steel base - Standard height
- Steel base - Low height
- Plastic base - Low height
- Soft casters
- Faux Leather upholstery
- Leather upholstery
- Stain repellent

- To specify, change the 4th digit from a 1 to a 3; **Example:** M253-1W42 (add \$102.93 list)
- To specify, change the 4th digit from a 1 to a 5; **Example:** M255-1W42
- To specify, change the 4th digit from a 1 to a 6; **Example:** M256-1W42
- To specify, change the 4th digit from a 1 to a 7; **Example:** M257-1W42
- To specify, change the 4th digit from a 1 to a 4; **Example:** M254-1W42
- To specify, change the 7th digit from a 4 to a 2; **Example:** M251-1W22
- To specify, change the 2nd digit from a 2 to a 3; **Example:** M351-1W42
- To specify, change the 2nd digit from a 2 to a 1; **Example:** M151-1W42
- To specify, add -P to the end of the product number; **Example:** M251-1W42-P (add \$39.68 list)

NOTE: High arc base available in black only.

For available fabrics, refer to surfaces.haworth.com.

Improv Series

Improv H.E. High-Back Chair without Arms



M251-1042

Dimensions

SH: 16" - 21"
(406mm - 533mm)
H: 36 1/2" - 45"
(957mm-1143mm)
D: 24" - 27 1/4"
(610mm - 692mm)
W: 26 1/2"(673mm)
SW: 19.2"(488mm)
SD: 16" - 19"
(406mm - 483mm)

Two-stage seat height:
.7"(18mm) below
standard
1.9"(48mm) above
standard

Features

- Outer Shells: Polypropylene or upholstered.
- Casters: Standard with hard casters; or optional soft casters, see below.
- 3"(76mm) sliding seat pan.
- Standard plastic base or optional high arc, or steel base.
- Mechanism: Swivel with synchronized-tilt.
- Height Adjustment: Pneumatic or pneumatic with two-stage seat height, see below.
- Optional Back-Lock: Lockable in two positions.
- Optional Forward Tilt: Lockable in 3 positions.
- Tilt tension.
- Optional Adjustable Air Lumbar: additional 1 1/2"(38mm) of lumbar support.
- Fire retardant construction is available to comply with California Bulletin #133, see below.
- COM yardage / COL square footage:
Polypropylene shell: 2.13/45
Upholstered shell: 2.75/62

To Order, Specify:

- 1) Product number.
- 2) Fabric surface and color.
(NOTE: For leather upholstery, see below.)
- 3) Trim color for shell and base.

* All measurements taken with the BIFMA chair measuring device.

Shells	Number	Fabric Grade		C	D	E	F	G	H	Leather Grade A	Leather Grade B
		A	B								
Pneumatic Height Adjustment											
Polypropylene	M251-1042	\$1026.76	\$1104.90	\$1186.72	\$1227.64	\$1263.58	\$1335.54	\$1401.24	\$1583.54	\$1710.00	\$1897.16
Upholstered	M251-2042	1155.73	1233.87	1315.69	1356.61	1392.55	1464.51	1530.21	1712.51	2073.35	2260.51
Pneumatic Height Adjustment/Back-Lock											
Polypropylene	M251-1041	\$1080.09	\$1158.23	\$1240.05	\$1280.97	\$1316.91	\$1388.87	\$1454.57	\$1636.87	\$1763.33	\$1950.49
Upholstered	M251-2041	1209.06	1287.20	1369.02	1409.94	1445.88	1517.84	1583.54	1765.84	2126.68	2313.84
Pneumatic Height Adjustment/Forward-Tilt											
Polypropylene	M261-1042	\$1078.84	\$1156.98	\$1238.80	\$1279.72	\$1315.66	\$1387.62	\$1453.32	\$1635.62	\$1762.08	\$1949.24
Upholstered	M261-2042	1207.81	1285.95	1367.77	1408.69	1444.63	1516.59	1582.29	1764.59	2125.43	2312.59
Pneumatic Height Adjustment with Adjustable Air Lumbar											
Polypropylene	M251-1044	\$1155.73	\$1233.87	\$1315.69	\$1356.61	\$1392.55	\$1464.51	\$1530.21	\$1712.51	\$1838.97	\$2026.13
Upholstered	M251-2044	1284.70	1362.84	1444.66	1485.58	1521.52	1593.48	1659.18	1841.48	2202.32	2389.48
Pneumatic Height Adjustment/Back-Lock with Adjustable Air Lumbar											
Polypropylene	M251-1043	\$1209.06	\$1287.20	\$1369.02	\$1409.94	\$1445.88	\$1517.84	\$1583.54	\$1765.84	\$1892.30	\$2079.46
Upholstered	M251-2043	1338.03	1416.17	1497.99	1538.91	1574.85	1646.81	1712.51	1894.81	2255.65	2442.81
Pneumatic Height Adjustment/Forward-Tilt with Adjustable Air Lumbar											
Polypropylene	M261-1044	\$1207.81	\$1285.95	\$1367.77	\$1408.69	\$1444.63	\$1516.59	\$1582.29	\$1764.59	\$1891.05	\$2078.21
Upholstered	M261-2044	1336.78	1414.92	1496.74	1537.66	1573.60	1645.56	1711.26	1893.56	2254.40	2441.56

The following options require modification of the product number.

- Two-stage seat height
- High arc base
- Steel base - Standard height
- Steel base - Low height
- Plastic base - Low height
- Soft casters
- Faux Leather upholstery
- Leather upholstery
- CAL 133
- Stain repellent

- To specify, change the 4th digit from a 1 to a 3; **Example:** M253-1042 (add \$102.93 list)
- To specify, change the 4th digit from a 1 to a 5; **Example:** M255-1042
- To specify, change the 4th digit from a 1 to a 6; **Example:** M256-1042
- To specify, change the 4th digit from a 1 to a 7; **Example:** M257-1042
- To specify, change the 4th digit from a 1 to a 4; **Example:** M254-1042
- To specify, change the 7th digit from a 4 to a 2; **Example:** M251-1022
- To specify, change the 2nd digit from a 2 to a 3; **Example:** M351-1042
- To specify, change the 2nd digit from a 2 to a 1; **Example:** M151-1042
- To specify, add -F to the end of the product number; **Example:** M251-2042-F (add \$120.28 list)
- To specify, add -P to the end of the product number; **Example:** M251-1042-P (add \$39.68 list)

NOTE: CAL 133 is available on all fully upholstered models and chairs with black (TR-F) polypropylene shells backs.

High arc base available in black only.

For available fabrics, refer to surfaces.haworth.com.

Improv Series

Improv H.E. Mid-Back Chair with Task Arms



M231-1442

Dimensions

SH: 16" - 21"
(406mm - 533mm)
H: 34" - 42 1/2"
(864mm - 1080mm)
D: 23" - 25 1/2"
(584mm - 648mm)
W: 25"(635mm)
SW: 19.2"(488mm)
SD: 16" - 19"
(406mm - 483mm)
AH: 9 5/8"(244mm)

Two-stage seat height:
.7"(18mm) below
standard
1.9"(48mm) above
standard

Features

- Outer Shells: Polypropylene or upholstered.
- Arms: Standard, upholstered fabric or soft black vinyl arm caps.
- Casters: Standard with hard casters; or optional soft casters.
- 3"(76mm) sliding seat pan.
- Standard plastic base or optional high arc, or steel base.
- Mechanism: Swivel with synchronized-tilt.
- Height Adjustment: Pneumatic, pneumatic with two-stage seat height, or pneumatic with low- position seat height.
- Optional Back-Lock: Lockable in two positions.
- Optional Forward Tilt: Lockable in 3 positions.
- Tilt tension.
- Optional Adjustable Air Lumbar: additional 1 1/2"(38mm) of lumbar support.
- Fire retardant construction is available to comply with California Bulletin #133.
- COM yardage / COL square footage:
Polypropylene shell: 1.50/39
Upholstered shell: 2.25/45

To Order, Specify:

- 1) Product number.
- 2) Fabric surface and color.
(NOTE: For leather upholstery, see page 207.)
- 3) Trim color for shell, arms and base.

* All measurements taken with the BIFMA chair measuring device.

Shells	Arms/Caps	Number	Fabric Grade		C	D	E	F	G	H	Leather Grade A	Leather Grade B
			A	B								
Pneumatic Height Adjustment												
Polypropylene	Standard	M231-1442	\$1047.85	\$1125.99	\$1207.81	\$1248.73	\$1284.67	\$1356.63	\$1422.33	\$1604.63	\$1731.09	\$1918.25
	Upholstered	M231-1542	1101.18	1179.32	1261.14	1302.06	1338.00	1409.96	1475.66	1657.96	1784.42	1971.58
	Soft Black Vinyl	M231-1642	1101.18	1179.32	1261.14	1302.06	1338.00	1409.96	1475.66	1657.96	1784.42	1971.58
Upholstered	Standard	M231-2442	\$1176.82	\$1254.96	\$1336.78	\$1377.70	\$1413.64	\$1485.60	\$1551.30	\$1733.60	\$2094.44	\$2281.60
	Upholstered	M231-2542	1230.15	1308.29	1390.11	1431.03	1466.97	1538.93	1604.63	1786.93	2147.77	2334.93
	Soft Black Vinyl	M231-2642	1230.15	1308.29	1390.11	1431.03	1466.97	1538.93	1604.63	1786.93	2147.77	2334.93
Pneumatic Height Adjustment/Back-Lock												
Polypropylene	Standard	M231-1441	\$1101.18	\$1179.32	\$1261.14	\$1302.06	\$1338.00	\$1409.96	\$1475.66	\$1657.96	\$1784.42	\$1971.58
	Upholstered	M231-1541	1154.51	1232.65	1314.47	1355.39	1391.33	1463.29	1528.99	1711.29	1837.75	2024.91
	Soft Black Vinyl	M231-1641	1154.51	1232.65	1314.47	1355.39	1391.33	1463.29	1528.99	1711.29	1837.75	2024.91
Upholstered	Standard	M231-2441	\$1230.15	\$1308.29	\$1390.11	\$1431.03	\$1466.97	\$1538.93	\$1604.63	\$1786.93	\$2147.77	\$2334.93
	Upholstered	M231-2541	1283.48	1361.62	1443.44	1484.36	1520.30	1592.26	1657.96	1840.26	2201.10	2388.26
	Soft Black Vinyl	M231-2641	1283.48	1361.62	1443.44	1484.36	1520.30	1592.26	1657.96	1840.26	2201.10	2388.26
Pneumatic Height Adjustment/Forward-Tilt												
Polypropylene	Standard	M241-1442	\$1099.93	\$1178.07	\$1259.89	\$1300.81	\$1336.75	\$1408.71	\$1474.41	\$1656.71	\$1783.17	\$1970.33
	Upholstered	M241-1542	1153.26	1231.40	1313.22	1354.14	1390.08	1462.04	1527.74	1710.04	1836.50	2023.66
	Soft Black Vinyl	M241-1642	1153.26	1231.40	1313.22	1354.14	1390.08	1462.04	1527.74	1710.04	1836.50	2023.66
Upholstered	Standard	M241-2442	\$1228.90	\$1307.04	\$1388.86	\$1429.78	\$1465.72	\$1537.68	\$1603.38	\$1785.68	\$2146.52	\$2333.68
	Upholstered	M241-2542	1282.23	1360.37	1442.19	1483.11	1519.05	1591.01	1656.71	1839.01	2199.85	2387.01
	Soft Black Vinyl	M241-2642	1282.23	1360.37	1442.19	1483.11	1519.05	1591.01	1656.71	1839.01	2199.85	2387.01

Improv Series

Improv H.E. Mid-Back Chair with Task Arms

Shells	Arms/Caps	Number	Fabric Grade								Leather Grade A	Leather Grade B
			A	B	C	D	E	F	G	H		
Pneumatic Height Adjustment with Adjustable Air Lumbar												
Polypropylene	Standard	M231-1444	\$1176.82	\$1254.96	\$1336.78	\$1377.70	\$1413.64	\$1485.60	\$1551.30	\$1733.60	\$1860.06	\$2047.22
	Upholstered	M231-1544	1230.15	1308.29	1390.11	1431.03	1466.97	1538.93	1604.63	1786.93	1913.39	2100.55
	Soft Black Vinyl	M231-1644	1230.15	1308.29	1390.11	1431.03	1466.97	1538.93	1604.63	1786.93	1913.39	2100.55
Upholstered	Standard	M231-2444	\$1305.79	\$1383.93	\$1465.75	\$1506.67	\$1542.61	\$1614.57	\$1680.27	\$1862.57	\$2223.41	\$2410.57
	Upholstered	M231-2544	1359.12	1437.26	1519.08	1560.00	1595.94	1667.90	1733.60	1915.90	2276.74	2463.90
	Soft Black Vinyl	M231-2644	1359.12	1437.26	1519.08	1560.00	1595.94	1667.90	1733.60	1915.90	2276.74	2463.90
Pneumatic Height Adjustment/Back-Lock with Adjustable Air Lumbar												
Polypropylene	Standard	M231-1443	\$1230.15	\$1308.29	\$1390.11	\$1431.03	\$1466.97	\$1538.93	\$1604.63	\$1786.93	\$1913.39	\$2100.55
	Upholstered	M231-1543	1283.48	1361.62	1443.44	1484.36	1520.30	1592.26	1657.96	1840.26	1966.72	2153.88
	Soft Black Vinyl	M231-1643	1283.48	1361.62	1443.44	1484.36	1520.30	1592.26	1657.96	1840.26	1966.72	2153.88
Upholstered	Standard	M231-2443	\$1359.12	\$1437.26	\$1519.08	\$1560.00	\$1595.94	\$1667.90	\$1733.60	\$1915.90	\$2276.74	\$2463.90
	Upholstered	M231-2543	1412.45	1490.59	1572.41	1613.33	1649.27	1721.23	1786.93	1969.23	2330.07	2517.23
	Soft Black Vinyl	M231-2643	1412.45	1490.59	1572.41	1613.33	1649.27	1721.23	1786.93	1969.23	2330.07	2517.23
Pneumatic Height Adjustment/Forward-Tilt with Adjustable Air Lumbar												
Polypropylene	Standard	M241-1444	\$1228.90	\$1307.04	\$1388.86	\$1429.78	\$1465.72	\$1537.68	\$1603.38	\$1785.68	\$1912.14	\$2099.30
	Upholstered	M241-1544	1282.23	1360.37	1442.19	1483.11	1519.05	1591.01	1656.71	1839.01	1965.47	2152.63
	Soft Black Vinyl	M241-1644	1282.23	1360.37	1442.19	1483.11	1519.05	1591.01	1656.71	1839.01	1965.47	2152.63
Upholstered	Standard	M241-2444	\$1357.87	\$1436.01	\$1517.83	\$1558.75	\$1594.69	\$1666.65	\$1732.35	\$1914.65	\$2275.49	\$2462.65
	Upholstered	M241-2544	1411.20	1489.34	1571.16	1612.08	1648.02	1719.98	1785.68	1967.98	2328.82	2515.98
	Soft Black Vinyl	M241-2644	1411.20	1489.34	1571.16	1612.08	1648.02	1719.98	1785.68	1967.98	2328.82	2515.98

The following options require modification of the product number.

Low-position seat height - Plastic	To specify, change the 4th digit from a 1 to a 4; Example: M234-1442
Two-stage seat height- HAB	To specify, change the 4th digit from a 1 to a 3; Example: M233-1442 (add \$102.93 list)
High arc base	To specify, change the 4th digit from a 1 to a 5; Example: M235-1442
Steel base - Standard height	To specify, change the 4th digit from a 1 to a 6; Example: M236-1442
Steel base - Low height	To specify, change the 4th digit from a 1 to a 7; Example: M237-1442
Soft casters	To specify, change the 7th digit from a 4 to a 2; Example: M231-1422
Faux Leather upholstery	To specify, change the 2nd digit from a 2 to a 3; Example: M331-1442
Leather upholstery	To specify, change the 2nd digit from a 2 to a 1; Example: M131-1442
CAL 133	To specify, add -F to the end of the product number; Example: M231-2542-F (add \$120.28 list)
Stain repellent	To specify, add -P to the end of the product number; Example: M231-1444-P (add \$39.68 list)

NOTE: CAL 133 is available on all fully upholstered models and chairs with black (TR-F) polypropylene shells backs.

High arc base available in black only.

For available fabrics, refer to surfaces.haworth.com.

Improv Series

Improv H.E. Mid-Back Chair with Height Adjustable Task Arms



M231-1742

Dimensions

SH: 16" - 21"
(406mm - 533mm)
H: 34" - 42 1/2"
(864mm - 1080mm)
D: 23" - 25 1/2"
(584mm - 648mm)
W: 25"(635mm)
SW: 19.2"(488mm)
SD: 16" - 19"
(406mm - 483mm)
AH: 4.6" - 8.4"
(117mm-213mm)

Two-stage seat height:
.7"(18mm) below
standard
1.9"(48mm) above
standard

Features

- Outer Shells: Polypropylene or upholstered.
- Arms: Standard, upholstered fabric or soft black vinyl arm caps.
- Arm Adjustment Controls: Fingertip activation.
- Casters: Standard with hard casters; or optional soft casters.
- 3"(76mm) sliding seat pan.
- Standard plastic base or optional high arc, or steel base.
- Mechanism: Swivel with synchronized-tilt.
- Height Adjustment: Pneumatic, pneumatic with two-stage seat height, or pneumatic with low-position seat height option.
- Arm Adjustment: 4"(102mm) height adjustment.
- Optional Back-Lock: Lockable in two positions.
- Optional Forward Tilt: Lockable in 3 positions.
- Tilt tension.
- Optional Adjustable Air Lumbar: additional 1 1/2"(38mm) of lumbar support.
- COM yardage / COL square footage:
Polypropylene shell: 1.50/39
Upholstered shell: 2.25/45

To Order, Specify:

- 1) Product number.
- 2) Fabric surface and color.
(NOTE: For leather upholstery, see page 209.)
- 3) Trim color for shell, arms and base.

* All measurements taken with the BIFMA chair measuring device.

Shells	Arms/Caps	Number	Fabric Grade		C	D	E	F	G	H	Leather Grade A	Leather Grade B
			A	B								
Pneumatic Height Adjustment												
Polypropylene	Standard	M231-1742	\$1159.45	\$1237.59	\$1319.41	\$1360.33	\$1396.27	\$1468.23	\$1533.93	\$1716.23	\$1842.69	\$2029.85
	Upholstered	M231-1842	1212.78	1290.92	1372.74	1413.66	1449.60	1521.56	1587.26	1769.56	1896.02	2083.18
	Soft Black Vinyl	M231-1942	1212.78	1290.92	1372.74	1413.66	1449.60	1521.56	1587.26	1769.56	1896.02	2083.18
Upholstered	Standard	M231-2742	\$1288.42	\$1366.56	\$1448.38	\$1489.30	\$1525.24	\$1597.20	\$1662.90	\$1845.20	\$2206.04	\$2393.20
	Upholstered	M231-2842	1341.75	1419.89	1501.71	1542.63	1578.57	1650.53	1716.23	1898.53	2259.37	2446.53
	Soft Black Vinyl	M231-2942	1341.75	1419.89	1501.71	1542.63	1578.57	1650.53	1716.23	1898.53	2259.37	2446.53
Pneumatic Height Adjustment/Back-Lock												
Polypropylene	Standard	M231-1741	\$1212.78	\$1290.92	\$1372.74	\$1413.66	\$1449.60	\$1521.56	\$1587.26	\$1769.56	\$1896.02	\$2083.18
	Upholstered	M231-1841	1266.11	1344.25	1426.07	1466.99	1574.89	1574.89	1640.59	1822.89	1949.35	2136.51
	Soft Black Vinyl	M231-1941	1266.11	1344.25	1426.07	1466.99	1502.93	1574.89	1640.59	1822.89	1949.35	2136.51
Upholstered	Standard	M231-2741	\$1341.75	\$1419.89	\$1501.71	\$1542.63	\$1578.57	\$1650.53	\$1716.23	\$1898.53	\$2259.37	\$2446.53
	Upholstered	M231-2841	1395.08	1473.22	1555.04	1595.96	1631.90	1703.86	1769.56	1951.86	2312.70	2499.86
	Soft Black Vinyl	M231-2941	1395.08	1473.22	1555.04	1595.96	1631.90	1703.86	1769.56	1951.86	2312.70	2499.86
Pneumatic Height Adjustment/Forward-Tilt												
Polypropylene	Standard	M241-1742	\$1211.53	\$1289.67	\$1371.49	\$1412.41	\$1448.35	\$1520.31	\$1586.01	\$1768.31	\$1894.77	\$2081.93
	Upholstered	M241-1842	1264.86	1343.00	1424.82	1465.74	1501.68	1573.64	1639.34	1821.64	1948.10	2135.26
	Soft Black Vinyl	M241-1942	1264.86	1343.00	1424.82	1465.74	1501.68	1573.64	1639.34	1821.64	1948.10	2135.26
Upholstered	Standard	M241-2742	\$1340.50	\$1418.64	\$1500.46	\$1541.38	\$1577.32	\$1649.28	\$1714.98	\$1897.28	\$2258.12	\$2445.28
	Upholstered	M241-2842	1393.83	1471.97	1553.79	1594.71	1630.65	1702.61	1768.31	1950.61	2311.45	2498.61
	Soft Black Vinyl	M241-2942	1393.83	1471.97	1553.79	1594.71	1630.65	1702.61	1768.31	1950.61	2311.45	2498.61

Improv Series

Improv H.E. Mid-Back Chair with Height Adjustable Task Arms

Shells	Arms/Caps	Number	Fabric Grade								Leather Grade A	Leather Grade B
			A	B	C	D	E	F	G	H		
Pneumatic Height Adjustment with Adjustable Air Lumbar												
Polypropylene	Standard	M231-1744	\$1288.42	\$1366.56	\$1448.38	\$1489.30	\$1525.24	\$1597.20	\$1662.90	\$1845.20	\$1971.66	\$2158.82
	Upholstered	M231-1844	1341.75	1419.89	1501.71	1542.63	1578.57	1650.53	1716.23	1898.53	2024.99	2212.15
	Soft Black Vinyl	M231-1944	1341.75	1419.89	1501.71	1542.63	1578.57	1650.53	1716.23	1898.53	2024.99	2212.15
Upholstered	Standard	M231-2744	\$1417.39	\$1495.53	\$1577.35	\$1618.27	\$1654.21	\$1726.17	\$1791.87	\$1974.17	\$2335.01	\$2522.17
	Upholstered	M231-2844	1470.72	1548.86	1630.68	1671.60	1707.54	1779.50	1845.20	2027.50	2388.34	2575.50
	Soft Black Vinyl	M231-2944	1470.72	1548.86	1630.68	1671.60	1707.54	1779.50	1845.20	2027.50	2388.34	2575.50
Pneumatic Height Adjustment/Back-Lock with Adjustable Air Lumbar												
Polypropylene	Standard	M231-1743	\$1341.75	\$1419.89	\$1501.71	\$1542.63	\$1578.57	\$1650.53	\$1716.23	\$1898.53	\$2024.99	\$2212.15
	Upholstered	M231-1843	1395.08	1473.22	1555.04	1595.96	1631.90	1703.86	1769.56	1951.86	2078.32	2265.48
	Soft Black Vinyl	M231-1943	1395.08	1473.22	1555.04	1595.96	1631.90	1703.86	1769.56	1951.86	2078.32	2265.48
Upholstered	Standard	M231-2743	\$1470.72	\$1548.86	\$1630.68	\$1671.60	\$1707.54	\$1779.50	\$1845.20	\$2027.50	\$2388.34	\$2575.50
	Upholstered	M231-2843	1524.05	1602.19	1684.01	1724.93	1760.87	1832.83	1898.53	2080.83	2441.67	2628.83
	Soft Black Vinyl	M231-2943	1524.05	1602.19	1684.01	1724.93	1760.87	1832.83	1898.53	2080.83	2441.67	2628.83
Pneumatic Height Adjustment/Forward-Tilt with Adjustable Air Lumbar												
Polypropylene	Standard	M241-1744	\$1340.50	\$1418.64	\$1500.46	\$1541.38	\$1577.32	\$1649.28	\$1714.98	\$1897.28	\$2023.74	\$2210.90
	Upholstered	M241-1844	1393.83	1471.97	1553.79	1594.71	1630.65	1702.61	1768.31	1950.61	2077.07	2264.23
	Soft Black Vinyl	M241-1944	1393.83	1471.97	1553.79	1594.71	1630.65	1702.61	1768.31	1950.61	2077.07	2264.23
Upholstered	Standard	M241-2744	\$1469.47	\$1547.61	\$1629.43	\$1670.35	\$1706.29	\$1778.25	\$1843.95	\$2026.25	\$2387.09	\$2574.25
	Upholstered	M241-2844	1522.80	1600.94	1682.76	1723.68	1759.62	1831.58	1897.28	2079.58	2440.42	2627.58
	Soft Black Vinyl	M241-2944	1522.80	1600.94	1682.76	1723.68	1759.62	1831.58	1897.28	2079.58	2440.42	2627.58

The following options require modification of the product number.

Low-position seat height - Plastic	To specify, change the 4th digit from a 1 to a 4; Example: M234-1742
Two-stage seat height- HAB	To specify, change the 4th digit from a 1 to a 3; Example: M233-1742 (add \$102.93 list)
High arc base	To specify, change the 4th digit from a 1 to a 5; Example: M235-1742
Steel base - Standard height	To specify, change the 4th digit from a 1 to a 6; Example: M236-1742
Steel base - Low height	To specify, change the 4th digit from a 1 to a 7; Example: M237-1742
Soft casters	To specify, change the 7th digit from a 4 to a 2; Example: M231-1722
Faux Leather upholstery	To specify, change the 2nd digit from a 2 to a 3; Example: M331-1742
Leather upholstery	To specify, change the 2nd digit from a 2 to a 1; Example: M131-1742
Stain repellent	To specify, add -P to the end of the product number; Example: M231-1744-P (add \$39.68 list)

NOTE: High arc base available in black only.

For available fabrics, refer to surfaces.haworth.com.

Improv Series

Improv H.E. Mid-Back Chair with Flipper Arms



M231-1H42

NOTE:
M241-1G42 offers the best value package of options for this model.

Dimensions

SH: 16" - 21"
(406mm - 533mm)
H: 34" - 42 1/2"
(864mm-1080mm)
D: 23" - 25 1/2"
(584mm - 648mm)
W: 26 1/2"(673mm)
SW: 19.2"(488mm)
SD: 16" - 19"
(406mm - 483mm)
AH: 6.2" - 11.3"
(157mm-287mm)

Two-stage seat height:
.7"(18mm) below
standard
1.9"(48mm) above
standard

Features

- Outer Shells: Polypropylene or upholstered.
- Arms: Standard, upholstered fabric or black vinyl gel arm caps.
- Arm Adjustment Controls: Fingertip activation.
- 3"(76mm) Sliding seat pan.
- Casters: Standard with hard casters; or optional soft casters.
- Standard plastic base or optional high arc, or steel base.
- Mechanism: Swivel with synchronized-tilt.
- Height Adjustment: Pneumatic, pneumatic with two-stage seat height, or pneumatic with low-position seat height option.
- Arm Adjustment: 5"(127mm) height adjustment.
- Arm Pad Rotation: 360°.
- Optional Back-Lock: Lockable in two positions.
- Optional Forward Tilt: Lockable in 3 positions.
- Tilt tension.
- Optional Adjustable Air Lumbar: additional 1 1/2"(38mm) of lumbar support.
- COM yardage / COL square footage:
Polypropylene shell: 1.50/39
Upholstered shell: 2.25/45

To Order, Specify:

- 1) Product number.
- 2) Fabric surface and color.
(NOTE: For leather upholstery, see page 211.)
- 3) Trim color for shell, arms and base.

* All measurements taken with the BIFMA chair measuring device.

Shells	Arms/Caps	Number	Fabric Grade		C	D	E	F	G	H	Leather Grade A	Leather Grade B
			A	B								
Pneumatic Height Adjustment												
Polypropylene	Standard	M231-1H42	\$1387.62	\$1465.76	\$1547.58	\$1588.50	\$1624.44	\$1696.40	\$1762.10	\$1944.40	\$2070.86	\$2258.02
	Vinyl Gel	M231-1G42	1455.82	1533.96	1615.78	1656.70	1692.64	1764.60	1830.30	2012.60	2139.06	2326.22
	Upholstered	M231-1U42	1504.18	1582.32	1664.14	1705.06	1741.00	1812.96	1878.66	2060.96	2187.42	2374.58
Upholstered	Standard	M231-2H42	\$1516.59	\$1594.73	\$1676.55	\$1717.47	\$1753.41	\$1825.37	\$1891.07	\$2073.37	\$2434.21	\$2621.37
	Vinyl Gel	M231-2G42	1584.79	1662.93	1744.75	1785.67	1821.61	1893.57	1959.27	2141.57	2502.41	2689.57
	Upholstered	M231-2U42	1633.15	1711.29	1793.11	1834.03	1869.97	1941.93	2007.63	2189.93	2550.77	2737.93
Pneumatic Height Adjustment/Back-Lock												
Polypropylene	Standard	M231-1H41	\$1440.95	\$1519.09	\$1600.91	\$1641.83	\$1677.77	\$1749.73	\$1815.43	\$1997.73	\$2124.19	\$2311.35
	Vinyl Gel	M231-1G41	1509.15	1587.29	1669.11	1710.03	1745.97	1817.93	1883.63	2065.93	2192.39	2379.55
	Upholstered	M231-1U41	1557.51	1635.65	1717.47	1758.39	1794.33	1866.29	1931.99	2114.29	2240.75	2427.91
Upholstered	Standard	M231-2H41	\$1569.92	\$1648.06	\$1729.88	\$1770.80	\$1806.74	\$1878.70	\$1944.40	\$2126.70	\$2487.54	\$2674.70
	Vinyl Gel	M231-2G41	1638.12	1716.26	1798.08	1839.00	1874.94	1946.90	2012.60	2194.90	2555.74	2742.90
	Upholstered	M231-2U41	1686.48	1764.62	1846.44	1887.36	1923.30	1995.26	2060.96	2243.26	2604.10	2791.26
Pneumatic Height Adjustment/Forward-Tilt												
Polypropylene	Standard	M241-1H42	\$1439.70	\$1517.84	\$1599.66	\$1640.58	\$1676.52	\$1748.48	\$1814.18	\$1996.48	\$2122.94	\$2310.10
	Vinyl Gel	M241-1G42	1507.90	1586.04	1667.86	1708.78	1744.72	1816.68	1882.38	2064.68	2191.14	2378.30
	Upholstered	M241-1U42	1556.26	1634.40	1716.22	1757.14	1793.08	1865.04	1930.74	2113.04	2239.50	2426.66
Upholstered	Standard	M241-2H42	\$1568.67	\$1646.81	\$1728.63	\$1769.55	\$1805.49	\$1877.45	\$1943.15	\$2125.45	\$2486.29	\$2673.45
	Vinyl Gel	M241-2G42	1636.87	1715.01	1796.83	1837.75	1873.69	1945.65	2011.35	2193.65	2554.49	2741.65
	Upholstered	M241-2U42	1685.23	1763.37	1845.19	1886.11	1922.05	1994.01	2059.71	2242.01	2602.85	2790.01

Improv Series

Improv H.E. Mid-Back Chair with Flipper Arms

Shells	Arms/Caps	Number	Fabric Grade								Leather Grade A	Leather Grade B
			A	B	C	D	E	F	G	H		
Pneumatic Height Adjustment with Adjustable Air Lumbar												
Polypropylene	Standard	M231-1H44	\$1516.59	\$1594.73	\$1676.55	\$1717.47	\$1753.41	\$1825.37	\$1891.07	\$2073.37	\$2199.83	\$2386.99
	Vinyl Gel	M231-1G44	1584.79	1662.93	1744.75	1785.67	1821.61	1893.57	1959.27	2141.57	2268.03	2455.19
	Upholstered	M231-1U44	1633.15	1711.29	1793.11	1834.03	1869.97	1941.93	2007.63	2189.93	2316.39	2503.55
Upholstered	Standard	M231-2H44	\$1645.56	\$1723.70	\$1805.52	\$1846.44	\$1882.38	\$1954.34	\$2020.04	\$2202.34	\$2563.18	\$2750.34
	Vinyl Gel	M231-2G44	1713.76	1791.90	1873.72	1914.64	1950.58	2022.54	2088.24	2270.54	2631.38	2818.54
	Upholstered	M231-2U44	1762.12	1840.26	1922.08	1963.00	1998.94	2070.90	2136.60	2318.90	2679.74	2866.90
Pneumatic Height Adjustment/Back-Lock with Adjustable Air Lumbar												
Polypropylene	Standard	M231-1H43	\$1569.92	\$1648.06	\$1729.88	\$1770.80	\$1806.74	\$1878.70	\$1944.40	\$2126.70	\$2253.16	\$2440.32
	Vinyl Gel	M231-1G43	1638.12	1716.26	1798.08	1839.00	1874.94	1946.90	2012.60	2194.90	2321.36	2508.52
	Upholstered	M231-1U43	1686.48	1764.62	1846.44	1887.36	1923.30	1995.26	2060.96	2243.26	2369.72	2556.88
Upholstered	Standard	M231-2H43	\$1698.89	\$1777.03	\$1858.85	\$1899.77	\$1935.71	\$2007.67	\$2073.37	\$2255.67	\$2616.51	\$2803.67
	Vinyl Gel	M231-2G43	1767.09	1845.23	1927.05	1967.97	2003.91	2075.87	2141.57	2323.87	2684.71	2871.87
	Upholstered	M231-2U43	1815.45	1893.59	1975.41	2016.33	2052.27	2124.23	2189.93	2372.23	2733.07	2920.23
Pneumatic Height Adjustment/Forward-Tilt with Adjustable Air Lumbar												
Polypropylene	Standard	M241-1H44	\$1568.67	\$1646.81	\$1728.63	\$1769.55	\$1805.49	\$1877.45	\$1943.15	\$2125.45	\$2251.91	\$2439.07
	Vinyl Gel	M241-1G44	1636.87	1715.01	1796.83	1837.75	1873.69	1945.65	2011.35	2193.65	2320.11	2507.27
	Upholstered	M241-1U44	1685.23	1763.37	1845.19	1886.11	1922.05	1994.01	2059.71	2242.01	2368.47	2555.63
Upholstered	Standard	M241-2H44	\$1697.64	\$1775.78	\$1857.60	\$1898.52	\$1934.46	\$2006.42	\$2072.12	\$2254.42	\$2615.26	\$2802.42
	Vinyl Gel	M241-2G44	1765.84	1843.98	1925.80	1966.72	2002.66	2074.62	2140.32	2322.62	2683.46	2870.62
	Upholstered	M241-2U44	1814.20	1892.34	1974.16	2015.08	2051.02	2122.98	2188.68	2370.98	2731.82	2918.98

The following options require modification of the product number.

Low-position seat height - Plastic
 Two-stage seat height- HAB
 High arc base
 Steel base - Standard height
 Steel base - Low height
 Soft casters
 Faux Leather upholstery
 Leather upholstery
 Stain repellent

To specify, change the 4th digit from a 1 to a 4; **Example:** M234-1H42
 To specify, change the 4th digit from a 1 to a 3; **Example:** M233-1H42 (add \$102.93 list)
 To specify, change the 4th digit from a 1 to a 5; **Example:** M235-1H42
 To specify, change the 4th digit from a 1 to a 6; **Example:** M236-1H42
 To specify, change the 4th digit from a 1 to a 7; **Example:** M237-1H42
 To specify, change the 7th digit from a 4 to a 2; **Example:** M231-1H22
 To specify, change the 2nd digit from a 2 to a 3; **Example:** M331-1H42
 To specify, change the 2nd digit from a 2 to a 1; **Example:** M131-1H42
 To specify, add **-P** to the end of the product number; **Example:** M231-1H44-P (add \$39.68 list)

NOTE: High arc base available in black only.

For available fabrics, refer to surfaces.haworth.com.

Improv Series

Improv H.E. Mid-Back Chair with Height and Width Adjustable 3-D Arms



M231-1W42

Dimensions

- SH: 16" - 21"
(406mm - 533mm)
- H: 34" - 42 1/2"
(864mm - 1080mm)
- D: 23" - 25 1/2"
(584mm - 648mm)
- W: 25"(635mm)
- SW: 19.2"(488mm)
- SD: 16" - 19"
(406mm - 483mm)
- AH: 3 3/4" - 7 3/4"
(95mm-197mm)
- AW: 25 1/2" - 29 1/4"
(648mm-743mm)

Two-stage seat height:
.7"(18mm) below
standard
1.9"(48mm) above
standard

Features

- Outer Shells: Polypropylene or upholstered.
- Arms: Molded black vinyl.
- 3"(76mm) Sliding seat pan.
- Casters: Standard with hard casters; or optional soft casters, see below.
- Standard plastic base or optional high arc, or steel base.
- Mechanism: Swivel with synchronized-tilt.
- Height Adjustment: Pneumatic, pneumatic with two-stage seat height, or pneumatic with low-position seat height option.
- Arm Adjustment: 4"(102mm) height adjustment.
- Arm Width Adjustment: 1 1/2"(38mm) each arm in-out adjustment.
- Arm Pad Rotation: 360°.
- Arm Adjustment Controls: Fingertip activation.
- Optional Back-Lock: Lockable in two positions.
- Optional Forward Tilt: Lockable in 3 positions.
- Tilt tension.
- Optional Adjustable Air Lumbar: additional 1 1/2"(38mm) of lumbar support.
- COM yardage / COL square footage:
Polypropylene shell: 1.50/39
Upholstered shell: 2.25/45

To Order, Specify:

- 1) Product number.
- 2) Fabric surface and color.
(NOTE: For leather upholstery, see below.)
- 3) Trim color for shell, arms and base.

* All measurements taken with the BIFMA chair measuring device.

Shells	Arms/Caps	Number	Fabric Grade								Leather Grade A	Leather Grade B
			A	B	C	D	E	F	G	H		
Pneumatic Height Adjustment												
Polypropylene	Molded Black Vinyl	M231-1W42	\$1297.09	\$1375.23	\$1457.05	\$1497.97	\$1533.91	\$1605.87	\$1671.57	\$1853.87	\$1980.33	\$2167.49
Upholstered	Molded Black Vinyl	M231-2W42	1426.06	1504.20	1586.02	1626.94	1662.88	1734.84	1800.54	1982.84	2343.68	2530.84
Pneumatic Height Adjustment/Back-Lock												
Polypropylene	Molded Black Vinyl	M231-1W41	\$1350.42	\$1428.56	\$1510.38	\$1551.30	\$1587.24	\$1659.20	\$1724.90	\$1907.20	\$2033.66	\$2220.82
Upholstered	Molded Black Vinyl	M231-2W41	1479.39	1557.53	1639.35	1680.27	1716.21	1788.17	1853.87	2036.17	2397.01	2584.17
Pneumatic Height Adjustment/Forward-Tilt												
Polypropylene	Molded Black Vinyl	M241-1W42	\$1349.17	\$1427.31	\$1509.13	\$1550.05	\$1585.99	\$1657.95	\$1723.65	\$1905.95	\$2032.41	\$2219.57
Upholstered	Molded Black Vinyl	M241-2W42	1478.14	1556.28	1638.10	1679.02	1714.96	1786.92	1852.62	2034.92	2395.76	2582.92
Pneumatic Height Adjustment with Adjustable Air Lumbar												
Polypropylene	Molded Black Vinyl	M231-1W44	\$1426.06	\$1504.20	\$1586.02	\$1626.94	\$1662.88	\$1734.84	\$1800.54	\$1982.84	\$2109.30	\$2296.46
Upholstered	Molded Black Vinyl	M231-2W44	1555.03	1633.17	1714.99	1755.91	1791.85	1863.81	1929.51	2111.81	2472.65	2659.81
Pneumatic Height Adjustment/Back-Lock with Adjustable Air Lumbar												
Polypropylene	Molded Black Vinyl	M231-1W43	\$1479.39	\$1557.53	\$1639.35	\$1680.27	\$1716.21	\$1788.17	\$1853.87	\$2036.17	\$2162.63	\$2349.79
Upholstered	Molded Black Vinyl	M231-2W43	1608.36	1686.50	1768.32	1809.24	1845.18	1917.14	1982.84	2165.14	2525.98	2713.14
Pneumatic Height Adjustment/Forward-Tilt with Adjustable Air Lumbar												
Polypropylene	Molded Black Vinyl	M241-1W44	\$1478.14	\$1556.28	\$1638.10	\$1679.02	\$1714.96	\$1786.92	\$1852.62	\$2034.92	\$2161.38	\$2348.54
Upholstered	Molded Black Vinyl	M241-2W44	1607.11	1685.25	1767.07	1807.99	1843.93	1915.89	1981.59	2163.89	2524.73	2711.89

The following options require modification of the product number.

- Low-position seat height - Plastic
- Two-stage seat height- HAB
- High arc base
- Steel base - Standard height
- Steel base - Low height
- Soft casters
- Faux Leather upholstery
- Leather upholstery
- Stain repellent

- To specify, change the 4th digit from a 1 to a 4; **Example:** M234-1W42
- To specify, change the 4th digit from a 1 to a 3; **Example:** M233-1W42 (add \$102.93 list)
- To specify, change the 4th digit from a 1 to a 5; **Example:** M235-1W42
- To specify, change the 4th digit from a 1 to a 6; **Example:** M236-1W42
- To specify, change the 4th digit from a 1 to a 7; **Example:** M237-1W42
- To specify, change the 7th digit from a 4 to a 2; **Example:** M231-1W22
- To specify, change the 2nd digit from a 2 to a 3; **Example:** M331-1W42
- To specify, change the 2nd digit from a 2 to a 1; **Example:** M131-1W42
- To specify, add -P to the end of the product number; **Example:** M231-1W42-P (add \$39.68 list)

NOTE: High arc base available in black only.

For available fabrics, refer to surfaces.haworth.com.

Improv Series

Improv H.E. Mid-Back Chair without Arms



M231-1042

Dimensions

SH: 16" - 21"
(406mm - 533mm)
H: 34" - 42 1/2"
(864mm - 1080mm)
D: 23" - 25 1/2"
(584mm - 648mm)
W: 26 1/2"(673mm)
SW: 19.2"(488mm)
SD: 16" - 19"
(406mm - 483mm)

Two-stage seat height:
.7"(18mm) below
standard
1.9"(48mm) above
standard

Features

- Outer Shells: Polypropylene or upholstered.
- 3"(76mm) Sliding seat pan.
- Casters: Standard with hard casters; or optional soft casters, see below.
- Standard plastic base or optional high arc, or steel base.
- Mechanism: Swivel with synchronized-tilt.
- Height Adjustment: Pneumatic, pneumatic with two-stage seat height, or pneumatic with low-position seat height option.
- Optional Back-Lock: Lockable in two positions.
- Optional Forward Tilt: Lockable in 3 positions.
- Tilt tension.
- Optional Adjustable Air Lumbar models available: additional 1 1/2"(38mm) of lumbar support.
- Fire retardant construction is available to comply with California Bulletin #133, see below.
- COM yardage / COL square footage:
Polypropylene shell: 1.50/39
Upholstered shell: 2.25/45

To Order, Specify:

- 1) Product number.
- 2) Fabric surface and color.
(NOTE: For leather upholstery, see below.)
- 3) Trim color for shell and base.

* All measurements taken with the BIFMA chair measuring device.

Shells	Number	Fabric Grade								Leather Grade A	Leather Grade B
		A	B	C	D	E	F	G	H		
Pneumatic Height Adjustment											
Polypropylene	M231-1042	\$ 943.68	\$1021.82	\$1103.64	\$1144.56	\$1180.50	\$1252.46	\$1318.16	\$1500.46	\$1626.92	\$1814.08
Upholstered	M231-2042	1072.65	1150.79	1232.61	1273.53	1309.47	1381.43	1447.13	1629.43	1990.27	2177.43
Pneumatic Height Adjustment/Back-Lock											
Polypropylene	M231-1041	\$ 997.01	\$1075.15	\$1156.97	\$1197.89	\$1233.83	\$1305.79	\$1371.49	\$1553.79	\$1680.25	\$1867.41
Upholstered	M231-2041	1125.98	1204.12	1285.94	1326.86	1362.80	1434.76	1500.46	1682.76	2043.60	2230.76
Pneumatic Height Adjustment/Forward-Tilt											
Polypropylene	M241-1042	\$ 995.76	\$1073.90	\$1155.72	\$1196.64	\$1232.58	\$1304.54	\$1370.24	\$1552.54	\$1679.00	\$1866.16
Upholstered	M241-2042	1124.73	1202.87	1284.69	1325.61	1361.55	1433.51	1499.21	1681.51	2042.35	2229.51
Pneumatic Height Adjustment with Adjustable Lumbar											
Polypropylene	M231-1044	\$1072.65	\$1150.79	\$1232.61	\$1273.53	\$1309.47	\$1381.43	\$1447.13	\$1629.43	\$1755.89	\$1943.05
Upholstered	M231-2044	1201.62	1279.76	1361.58	1402.50	1438.44	1510.40	1576.10	1758.40	2119.24	2306.40
Pneumatic Height Adjustment/Back-Lock with Adjustable Air Lumbar											
Polypropylene	M231-1043	\$1125.98	\$1204.12	\$1285.94	\$1326.86	\$1362.80	\$1434.76	\$1500.46	\$1682.76	\$1809.22	\$1996.38
Upholstered	M231-2043	1254.95	1333.09	1414.91	1455.83	1491.77	1563.73	1629.43	1811.73	2172.57	2359.73
Pneumatic Height Adjustment/Forward-Tilt with Adjustable Air Lumbar											
Polypropylene	M241-1044	\$1124.73	\$1202.87	\$1284.69	\$1325.61	\$1361.55	\$1433.51	\$1499.21	\$1681.51	\$1807.97	\$1995.13
Upholstered	M241-2044	1253.70	1331.84	1413.66	1454.58	1490.52	1562.48	1628.18	1810.48	2171.32	2358.48

The following options require modification of the product number.

- Low-position seat height - Plastic
- Two-stage seat height- HAB
- High arc base
- Steel base - Standard height
- Steel base - Low height
- Soft casters
- Faux Leather upholstery
- Leather upholstery
- CAL 133
- Stain repellent

- To specify, change the 4th digit from a 1 to a 4; **Example:** M234-1042
- To specify, change the 4th digit from a 1 to a 3; **Example:** M233-1042 (add \$102.93 list)
- To specify, change the 4th digit from a 1 to a 5; **Example:** M235-1042
- To specify, change the 4th digit from a 1 to a 6; **Example:** M236-1042
- To specify, change the 4th digit from a 1 to a 7; **Example:** M237-1042
- To specify, change the 7th digit from a 4 to a 2; **Example:** M231-1022
- To specify, change the 2nd digit from a 2 to a 3; **Example:** M331-1042
- To specify, change the 2nd digit from a 2 to a 1; **Example:** M131-1042
- To specify, add -F to the end of the product number; **Example:** M231-2042-F (add \$120.28 list)
- To specify, add -P to the end of the product number; **Example:** M231-1042-P (add \$39.68 list)

NOTE: CAL 133 is available on all fully upholstered models and chairs with black (TR-F) polypropylene shells backs.

High arc base available in black only.

For available fabrics, refer to surfaces.haworth.com.

Improv Series

Improv H.E. Stool with Task Arms



M2E1-1442

Dimensions

SH:	24" - 32" (610mm - 813mm)
H:	42" - 54" (1067mm - 1372mm)
D:	23" - 25 1/2" (584mm - 648mm)
W:	25" (635mm)
SW:	19.2" (488mm)
SD:	18" (459mm)
AH:	9.6" (244mm)

Features

- Outer Shells: Polypropylene or upholstered.
- Arms: Standard, upholstered fabric or soft black vinyl arm caps.
- Casters: Standard with hard casters; or optional soft casters or glides.
- Mechanism: Swivel with synchronized-tilt.
- Height Adjustment: Pneumatic
- Optional Back-Lock: Lockable in two positions.
- Tilt tension.
- Optional Adjustable Air Lumbar: additional 1 1/2" (38mm) of lumbar support.
- Forward tilt not available on stools.
- Seat pan can be manually adjusted 3" (76mm).
Foot ring adjustment: 6 1/2" - 15" (165mm - 381mm).
- Foot ring available in chrome only; ring support black only; base cover will match trim color.
- Fire retardant construction is available to comply with California Bulletin #133.
- COM yardage / COL square footage:
Polypropylene shell: 1.75/39
Upholstered shell: 2.25/45

To Order, Specify:

- 1) Product number.
- 2) Fabric surface and color. (NOTE: For leather upholstery, see page 215.)
- 3) Trim color for shell, arms and base.

* All measurements taken with the BIFMA chair measuring device.

Shells	Arms/Caps	Number	Fabric Grade		C	D	E	F	G	H	Leather Grade A	Leather Grade B
			A	B								
Pneumatic Height Adjustment												
Polypropylene	Standard	M2E1-1442	\$1608.35	\$1686.49	\$1768.31	\$1809.23	\$1845.17	\$1917.13	\$1982.83	\$2165.13	\$2291.59	\$2478.75
	Upholstered	M2E1-1542	1661.68	1739.82	1821.64	1862.56	1898.50	1970.46	2036.16	2218.46	2344.92	2532.08
	Soft Black Vinyl	M2E1-1642	1661.68	1739.82	1821.64	1862.56	1898.50	1970.46	2036.16	2218.46	2344.92	2532.08
Upholstered	Standard	M2E1-2442	\$1737.32	\$1815.46	\$1897.28	\$1938.20	\$1974.14	\$2046.10	\$2111.80	\$2294.10	\$2654.94	\$2842.10
	Upholstered	M2E1-2542	1790.65	1868.79	1950.61	1991.53	2027.47	2099.43	2165.13	2347.43	2708.27	2895.43
	Soft Black Vinyl	M2E1-2642	1790.65	1868.79	1950.61	1991.53	2027.47	2099.43	2165.13	2347.43	2708.27	2895.43
Pneumatic Height Adjustment/Back-Lock												
Polypropylene	Standard	M2E1-1441	\$1661.68	\$1739.82	\$1821.64	\$1862.56	\$1898.50	\$1970.46	\$2036.16	\$2218.46	\$2344.92	\$2532.08
	Upholstered	M2E1-1541	1715.01	1793.15	1874.97	1915.89	1951.83	2023.79	2089.49	2271.79	2398.25	2585.41
	Soft Black Vinyl	M2E1-1641	1715.01	1793.15	1874.97	1915.89	1951.83	2023.79	2089.49	2271.79	2398.25	2585.41
Upholstered	Standard	M2E1-2441	\$1790.65	\$1868.79	\$1950.61	\$1991.53	\$2027.47	\$2099.43	\$2165.13	\$2347.43	\$2708.27	\$2895.43
	Upholstered	M2E1-2541	1843.98	1922.12	2003.94	2044.86	2080.80	2152.76	2218.46	2400.76	2761.60	2948.76
	Soft Black Vinyl	M2E1-2641	1843.98	1922.12	2003.94	2044.86	2080.80	2152.76	2218.46	2400.76	2761.60	2948.76

Improv Series

Improv H.E. Stool with Task Arms

Shells	Arms/Caps	Number	Fabric Grade								Leather Grade A	Leather Grade B
			A	B	C	D	E	F	G	H		
Pneumatic Height Adjustment with Adjustable Air Lumbar												
Polypropylene	Standard	M2E1-1444	\$1737.32	\$1815.46	\$1897.28	\$1938.20	\$1974.14	\$2046.10	\$2111.80	\$2294.10	\$2420.56	\$2607.72
	Upholstered	M2E1-1544	1790.65	1868.79	1950.61	1991.53	2027.47	2099.43	2165.13	2347.43	2473.89	2661.05
	Soft Black Vinyl	M2E1-1644	1790.65	1868.79	1950.61	1991.53	2027.47	2099.43	2165.13	2347.43	2473.89	2661.05
Upholstered	Standard	M2E1-2444	\$1866.29	\$1944.43	\$2026.25	\$2067.17	\$2103.11	\$2175.07	\$2240.77	\$2423.07	\$2783.91	\$2971.07
	Upholstered	M2E1-2544	1919.62	1997.76	2079.58	2120.50	2156.44	2228.40	2294.10	2476.40	2837.24	3024.40
	Soft Black Vinyl	M2E1-2644	1919.62	1997.76	2079.58	2120.50	2156.44	2228.40	2294.10	2476.40	2837.24	3024.40
Pneumatic Height Adjustment/Back-Lock with Adjustable Air Lumbar												
Polypropylene	Standard	M2E1-1443	\$1790.65	\$1868.79	\$1950.61	\$1991.53	\$2027.47	\$2099.43	\$2165.13	\$2347.43	\$2473.89	\$2661.05
	Upholstered	M2E1-1543	1843.98	1922.12	2003.94	2044.86	2080.80	2152.76	2218.46	2400.76	2527.22	2714.38
	Soft Black Vinyl	M2E1-1643	1843.98	1922.12	2003.94	2044.86	2080.80	2152.76	2218.46	2400.76	2527.22	2714.38
Upholstered	Standard	M2E1-2443	\$1919.62	\$1997.76	\$2079.58	\$2120.50	\$2156.44	\$2228.40	\$2294.10	\$2476.40	\$2837.24	\$3024.40
	Upholstered	M2E1-2543	1972.95	2051.09	2132.91	2173.83	2209.77	2281.73	2347.43	2529.73	2890.57	3077.73
	Soft Black Vinyl	M2E1-2643	1972.95	2051.09	2132.91	2173.83	2209.77	2281.73	2347.43	2529.73	2890.57	3077.73

The following options require modification of the product number.

Glides	To specify, change the 7th digit from a 4 to a 0; Example: M2E1-1402
Soft casters	To specify, change the 7th digit from a 4 to a 2; Example: M2E1-1422
Faux Leather upholstery	To specify, change the 2nd digit from a 2 to a 3; Example: M3E1-1442
Leather upholstery	To specify, change the 2nd digit from a 2 to a 1; Example: M1E1-1442
CAL 133	To specify, add -F to the end of the product number; Example: M2E1-2542-F (add \$120.28 list)
Stain repellent	To specify, add -P to the end of the product number; Example: M2E1-1444-P (add \$39.68 list)
NOTE: CAL 133 is available on all fully upholstered models and chairs with black (TR-F) polypropylene shells backs.	
For available fabrics, refer to surfaces.haworth.com .	

Improv Series

Improv H.E. Stool with Height Adjustable Task Arms



M2E1-1742

Dimensions

SH:	24" - 32" (610mm - 813mm)
H:	42" - 54" (1067mm - 1372mm)
D:	23" - 25 1/2" (584mm - 648mm)
W:	25" (635mm)
SW:	19.2" (488mm)
SD:	18" (458mm)
AH:	6.9" - 10.8" (175mm - 274mm)

Features

- Outer Shells: Polypropylene or upholstered.
- Arms: Standard, upholstered fabric or soft black vinyl arm caps.
- Arm Adjustment Controls: Fingertip activation.
- Standard with hard casters; or optional soft casters or glides.
- Mechanism: Swivel with synchronized-tilt.
- Height Adjustment: Pneumatic
- Arm Adjustment: 5" (127mm) height adjustment.
- Optional Back-Lock: Lockable in two positions.
- Tilt tension.
- Optional Adjustable Air Lumbar: additional 1 1/2" (38mm) of lumbar support.
- Forward tilt not available on stools.
- Seat pan can be manually adjusted 3" (76mm).
- Foot ring adjustment: 6 1/2" - 15" (165mm - 381mm).
- Foot ring available in chrome only; ring support black only; base cover will match trim color.
- COM yardage / COL square footage:
Polypropylene shell: 1.75/39
Upholstered shell: 2.25/45

To Order, Specify:

- 1) Product number.
- 2) Fabric surface and color. (NOTE: For leather upholstery, see page 217.)
- 3) Trim color for shell, arms and base.

* All measurements taken with the BIFMA chair measuring device.

Shells	Arms/Caps	Number	Fabric Grade		C	D	E	F	G	H	Leather Grade A	Leather Grade B
			A	B								
Pneumatic Height Adjustment												
Polypropylene	Standard	M2E1-1742	\$1719.95	\$1798.09	\$1879.91	\$1920.83	\$1956.77	\$2028.73	\$2094.43	\$2276.73	\$2403.19	\$2590.35
	Upholstered	M2E1-1842	1773.28	1851.42	1933.24	1974.16	2010.10	2082.06	2147.76	2330.06	2456.52	2643.68
	Soft Black Vinyl	M2E1-1942	1773.28	1851.42	1933.24	1974.16	2010.10	2082.06	2147.76	2330.06	2456.52	2643.68
Upholstered	Standard	M2E1-2742	\$1848.92	\$1927.06	\$2008.88	\$2049.80	\$2085.74	\$2157.70	\$2223.40	\$2405.70	\$2766.54	\$2953.70
	Upholstered	M2E1-2842	1902.25	1980.39	2062.21	2103.13	2139.07	2211.03	2276.73	2459.03	2819.87	3007.03
	Soft Black Vinyl	M2E1-2942	1902.25	1980.39	2062.21	2103.13	2139.07	2211.03	2276.73	2459.03	2819.87	3007.03
Pneumatic Height Adjustment/Back-Lock												
Polypropylene	Standard	M2E1-1741	\$1773.28	\$1851.42	\$1933.24	\$1974.16	\$2010.10	\$2082.06	\$2147.76	\$2330.06	\$2456.52	\$2643.68
	Upholstered	M2E1-1841	1826.61	1904.75	1986.57	2027.49	2063.43	2135.39	2201.09	2383.39	2509.85	2697.01
	Soft Black Vinyl	M2E1-1941	1826.61	1904.75	1986.57	2027.49	2063.43	2135.39	2201.09	2383.39	2509.85	2697.01
Upholstered	Standard	M2E1-2741	\$1902.25	\$1980.39	\$2062.21	\$2103.13	\$2139.07	\$2211.03	\$2276.73	\$2459.03	\$2819.87	\$3007.03
	Upholstered	M2E1-2841	1955.58	2033.72	2115.54	2156.46	2192.40	2264.36	2330.06	2512.36	2873.20	3060.36
	Soft Black Vinyl	M2E1-2941	1955.58	2033.72	2115.54	2156.46	2192.40	2264.36	2330.06	2512.36	2873.20	3060.36

Improv Series

Improv H.E. Stool with Height Adjustable Task Arms

Shells	Arms/Caps	Number	Fabric Grade								Leather Grade A	Leather Grade B
			A	B	C	D	E	F	G	H		
Pneumatic Height Adjustment with Adjustable Air Lumbar												
Polypropylene	Standard	M2E1-1744	\$1848.92	\$1927.06	\$2008.88	\$2049.80	\$2085.74	\$2157.70	\$2223.40	\$2405.70	\$2532.16	\$2719.32
	Upholstered	M2E1-1844	1902.25	1980.39	2062.21	2103.13	2139.07	2211.03	2276.73	2459.03	2585.49	2772.65
	Soft Black Vinyl	M2E1-1944	1902.25	1980.39	2062.21	2103.13	2139.07	2211.03	2276.73	2459.03	2585.49	2772.65
Upholstered	Standard	M2E1-2744	\$1977.89	\$2056.03	\$2137.85	\$2178.77	\$2214.71	\$2286.67	\$2352.37	\$2534.67	\$2895.51	\$3082.67
	Upholstered	M2E1-2844	2031.22	2109.36	2191.18	2232.10	2268.04	2340.00	2405.70	2588.00	2948.84	3136.00
	Soft Black Vinyl	M2E1-2944	2031.22	2109.36	2191.18	2232.10	2268.04	2340.00	2405.70	2588.00	2948.84	3136.00
Pneumatic Height Adjustment/Back-Lock with Adjustable Air Lumbar												
Polypropylene	Standard	M2E1-1743	\$1902.25	\$1980.39	\$2062.21	\$2103.13	\$2139.07	\$2211.03	\$2276.73	\$2459.03	\$2585.49	\$2772.65
	Upholstered	M2E1-1843	1955.58	2033.72	2115.54	2156.46	2192.40	2264.36	2330.06	2512.36	2638.82	2825.98
	Soft Black Vinyl	M2E1-1943	1955.58	2033.72	2115.54	2156.46	2192.40	2264.36	2330.06	2512.36	2638.82	2825.98
Upholstered	Standard	M2E1-2743	\$2031.22	\$2109.36	\$2191.18	\$2232.10	\$2268.04	\$2340.00	\$2405.70	\$2588.00	\$2948.84	\$3136.00
	Upholstered	M2E1-2843	2084.55	2162.69	2244.51	2285.43	2321.37	2393.33	2459.03	2641.33	3002.17	3189.33
	Soft Black Vinyl	M2E1-2943	2084.55	2162.69	2244.51	2285.43	2321.37	2393.33	2459.03	2641.33	3002.17	3189.33

The following options require modification of the product number.

Glides	To specify, change the 7th digit from a 4 to a 0; Example: M2E1-1702
Soft casters	To specify, change the 7th digit from a 4 to a 2; Example: M2E1-1722
Faux Leather upholstery	To specify, change the 2nd digit from a 2 to a 3; Example: M3E1-1742
Leather upholstery	To specify, change the 2nd digit from a 2 to a 1; Example: M1E1-1742
Stain repellent	To specify, add -P to the end of the product number; Example: M2E1-1744-P (add \$39.68 list)
NOTE: For available fabrics, refer to surfaces.haworth.com .	

Improv Series

Improv H.E. Stool with Flipper Arms



M2E1-1H42

Dimensions

SH: 24" - 32"
(610mm - 813mm)
H: 42" - 54"
(1067mm - 1372mm)
D: 23" - 25 1/2"
(584mm - 648mm)
W: 26 1/2"(673mm)
SW: 19.2"(488mm)
SD: 18"(458mm)
AH: 6.2" - 11.3"
(157mm - 282mm)

Features

- Outer Shells: Polypropylene or upholstered.
- Arms: Standard, upholstered fabric or black vinyl arm caps.
- Arm Adjustment Controls: Fingertip activation.
- Arm Adjustment: 5"(127mm) height adjustment, 360° rotation.
- Standard with hard casters; or optional soft casters or glides.
- Mechanism: Swivel with synchronized-tilt.
- Height Adjustment: Pneumatic
- Optional Back-Lock: Lockable in two positions.
- Tilt tension.
- Optional Adjustable Air Lumbar: additional 1 1/2"(38mm) of lumbar support.
- Forward tilt not available on stools.
- Seat pan can be manually adjusted 3"(76mm).
- Foot ring adjustment: 6 1/2" - 15" (165mm - 381mm).
- Foot ring available in chrome only; ring support black only; base cover will match trim color.
- COM yardage / COL square footage:
Polypropylene shell: 1.75/39
Upholstered shell: 2.25/45

To Order, Specify:

- 1) Product number.
- 2) Fabric surface and color. (NOTE: For leather upholstery, see page 219.)
- 3) Trim color for shell, arms and base.

* All measurements taken with the BIFMA chair measuring device.

Shells	Arms/Caps	Number	Fabric Grade		C	D	E	F	G	H	Leather Grade A	Leather Grade B
			A	B								
Pneumatic Height Adjustment												
Polypropylene	Standard	M2E1-1H42	\$1948.12	\$2026.26	\$2108.08	\$2149.00	\$2184.94	\$2256.90	\$2322.60	\$2504.90	\$2631.36	\$2818.52
	Vinyl Gel	M2E1-1G42	2016.32	2094.46	2176.28	2217.20	2253.14	2325.10	2390.80	2573.10	2699.56	2886.72
	Upholstered	M2E1-1U42	2064.68	2142.82	2224.64	2265.56	2301.50	2373.46	2439.16	2621.46	2747.92	2935.08
Upholstered	Standard	M2E1-2H42	\$2077.09	\$2155.23	\$2237.05	\$2277.97	\$2313.91	\$2385.87	\$2451.57	\$2633.87	\$2994.71	\$3181.87
	Vinyl Gel	M2E1-2G42	2145.29	2223.43	2305.25	2346.17	2382.11	2454.07	2519.77	2702.07	3062.91	3250.07
	Upholstered	M2E1-2U42	2193.65	2271.79	2353.61	2394.53	2430.47	2502.43	2568.13	2750.43	3111.27	3298.43
Pneumatic Height Adjustment/Back-Lock												
Polypropylene	Standard	M2E1-1H41	\$2001.45	\$2079.59	\$2161.41	\$2202.33	\$2238.27	\$2310.23	\$2375.93	\$2558.23	\$2684.69	\$2871.85
	Vinyl Gel	M2E1-1G41	2069.65	2147.79	2229.61	2270.53	2306.47	2378.43	2444.13	2626.43	2752.89	2940.05
	Upholstered	M2E1-1U41	2118.01	2196.15	2277.97	2318.89	2354.83	2426.79	2492.49	2674.79	2801.25	2988.41
Upholstered	Standard	M2E1-2H41	\$2130.42	\$2208.56	\$2290.38	\$2331.30	\$2367.24	\$2439.20	\$2504.90	\$2687.20	\$3048.04	\$3235.20
	Vinyl Gel	M2E1-2G41	2198.62	2276.76	2358.58	2399.50	2435.44	2507.40	2573.10	2755.40	3116.24	3303.40
	Upholstered	M2E1-2U41	2246.98	2325.12	2406.94	2447.86	2483.80	2555.76	2621.46	2803.76	3164.60	3351.76

Improv Series

Improv H.E. Stool with Flipper Arms

Shells	Arms/Caps	Number	Fabric Grade								Leather Grade A	Leather Grade B
			A	B	C	D	E	F	G	H		
Pneumatic Height Adjustment with Adjustable Air Lumbar												
Polypropylene	Standard	M2E1-1H44	\$2077.09	\$2155.23	\$2237.05	\$2277.97	\$2313.91	\$2385.87	\$2451.57	\$2633.87	\$2760.33	\$2947.49
	Vinyl Gel	M2E1-1G44	2145.29	2223.43	2305.25	2346.17	2382.11	2454.07	2519.77	2702.07	2828.53	3015.69
	Upholstered	M2E1-1U44	2193.65	2271.79	2353.61	2394.53	2430.47	2502.43	2568.13	2750.43	2876.89	3064.05
Upholstered	Standard	M2E1-2H44	\$2206.06	\$2284.20	\$2366.02	\$2406.94	\$2442.88	\$2514.84	\$2580.54	\$2762.84	\$3123.68	\$3310.84
	Vinyl Gel	M2E1-2G44	2274.26	2352.40	2434.22	2475.14	2511.08	2583.04	2648.74	2831.04	3191.88	3379.04
	Upholstered	M2E1-2U44	2322.62	2400.76	2482.58	2523.50	2559.44	2631.40	2697.10	2879.40	3240.24	3427.40
Pneumatic Height Adjustment/Back-Lock with Adjustable Air Lumbar												
Polypropylene	Standard	M2E1-1H43	\$2130.42	\$2208.56	\$2290.38	\$2331.30	\$2367.24	\$2439.20	\$2504.90	\$2687.20	\$2813.66	\$3000.82
	Vinyl Gel	M2E1-1G43	2198.62	2276.76	2358.58	2399.50	2435.44	2507.40	2573.10	2755.40	2881.86	3069.02
	Upholstered	M2E1-1U43	2246.98	2325.12	2406.94	2447.86	2483.80	2555.76	2621.46	2803.76	2930.22	3117.38
Upholstered	Standard	M2E1-2H43	\$2259.39	\$2337.53	\$2419.35	\$2460.27	\$2496.21	\$2568.17	\$2633.87	\$2816.17	\$3177.01	\$3364.17
	Vinyl Gel	M2E1-2G43	2327.59	2405.73	2487.55	2528.47	2564.41	2636.37	2702.07	2884.37	3245.21	3432.37
	Upholstered	M2E1-2U43	2375.95	2454.09	2535.91	2576.83	2612.77	2684.73	2750.43	2932.73	3293.57	3480.73

The following options require modification of the product number.

Glides	To specify, change the 7th digit from a 4 to a 0; Example: M2E1-1H02
Soft casters	To specify, change the 7th digit from a 4 to a 2; Example: M2E1-1H22
Faux Leather upholstery	To specify, change the 2nd digit from a 2 to a 3; Example: M3E1-1H42
Leather upholstery	To specify, change the 2nd digit from a 2 to a 1; Example: M1E1-1H42
Stain repellent	To specify, add -P to the end of the product number; Example: M2E1-2U42- P (add \$39.68 list)
NOTE: For available fabrics, refer to surfaces.haworth.com .	

Improv Series

Improv H.E. Stool with Height and Width Adjustable 3-D Arms



M2E1-1W42

Dimensions

- SH: 24" - 32"
(610mm - 813mm)
- H: 42" - 54"
(1067mm - 1372mm)
- D: 23" - 25 1/2"
(584mm - 648mm)
- W: 25"(635mm)
- SW: 19.2"(488mm)
- SD: 18"(458mm)
- AH: 3 3/4" - 7 3/4"
(95mm - 197mm)
- AW: 25 1/2" - 29 1/4"
(648mm - 743mm)

Features

- Outer Shells: Polypropylene or upholstered.
- Arms: Molded black vinyl arm caps.
- Standard with hard casters; or optional soft casters or glides, see below.
- Mechanism: Swivel with synchronized-tilt.
- Height Adjustment: Pneumatic
- Arm Adjustment: 5"(127mm) height adjustment.
- Arm Width Adjustment: 1 1/2"(38mm) each arm in-out adjustment.
- Arm Pad Rotation: 360°.
- Arm Adjustment Controls: Fingertip activation.
- Optional Back-Lock: Lockable in two positions.
- Tilt tension.
- Optional Adjustable Air Lumbar: additional 1 1/2"(38mm) of lumbar support.
- Forward tilt not available on stools.
- Seat pan can be manually adjusted 3"(76mm).
- Foot ring adjustment: 6 1/2" - 15"
(165mm - 381mm).
- Foot ring available in chrome only; ring support black only; base cover will match trim color.
- COM yardage / COL square footage:
Polypropylene shell: 1.75/39
Upholstered shell: 2.25/45

To Order, Specify:

- 1) Product number.
- 2) Fabric surface and color.
(NOTE: For leather upholstery, see below.)
- 3) Trim color for shell, arms and base.

* All measurements taken with the BIFMA chair measuring device.

Shells	Arms/Caps	Number	Fabric Grade								Leather Grade A	Leather Grade B
			A	B	C	D	E	F	G	H		
Pneumatic Height Adjustment												
Polypropylene	Molded Black Vinyl	M2E1-1W42	\$1857.59	\$1935.73	\$2017.55	\$2058.47	\$2094.41	\$2166.37	\$2232.07	\$2414.37	\$2540.83	\$2727.99
Upholstered	Molded Black Vinyl	M2E1-2W42	1986.56	2064.70	2146.52	2187.44	2223.38	2295.34	2361.04	2543.34	2904.18	3091.34
Pneumatic Height Adjustment/Back-Lock												
Polypropylene	Molded Black Vinyl	M2E1-1W41	\$1910.92	\$1989.06	\$2070.88	\$2111.80	\$2147.74	\$2219.70	\$2285.40	\$2467.70	\$2594.16	\$2781.32
Upholstered	Molded Black Vinyl	M2E1-2W41	2039.89	2118.03	2199.85	2240.77	2276.71	2348.67	2414.37	2596.67	2957.51	3144.67
Pneumatic Height Adjustment with Adjustable Air Lumbar												
Polypropylene	Molded Black Vinyl	M2E1-1W44	\$1986.56	\$2064.70	\$2146.52	\$2187.44	\$2223.38	\$2295.34	\$2361.04	\$2543.34	\$2669.80	\$2856.96
Upholstered	Molded Black Vinyl	M2E1-2W44	2115.53	2193.67	2275.49	2316.41	2352.35	2424.31	2490.01	2672.31	3033.15	3220.31
Pneumatic Height Adjustment/Back-Lock with Adjustable Air Lumbar												
Polypropylene	Molded Black Vinyl	M2E1-1W43	\$2039.89	\$2118.03	\$2199.85	\$2240.77	\$2276.71	\$2348.67	\$2414.37	\$2596.67	\$2723.13	\$2910.29
Upholstered	Molded Black Vinyl	M2E1-2W43	2168.86	2247.00	2328.82	2369.74	2405.68	2477.64	2543.34	2725.64	3086.48	3273.64

The following options require modification of the product number.

- | | |
|---|---|
| <ul style="list-style-type: none"> Glide Soft casters Faux Leather upholstery Leather upholstery Stain repellent | <ul style="list-style-type: none"> To specify, change the 7th digit from a 4 to a 0; Example: M2E1-1W02 To specify, change the 7th digit from a 4 to a 2; Example: M2E1-1W22 To specify, change the 2nd digit from a 2 to a 3; Example: M3E1-1W42 To specify, change the 2nd digit from a 2 to a 1; Example: M1E1-1W42 To specify, add -P to the end of the product number; Example: M2E1-1W42-P (add \$39.68 list) <p>NOTE: For available fabrics, refer to surfaces.haworth.com.</p> |
|---|---|

Improv Series

Improv H.E. Stool without Arms

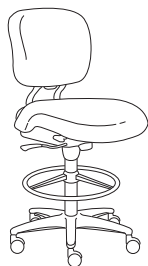

M2E1-1042

Dimensions

- SH: 24" - 32"
(610mm - 813mm)
- H: 42" - 54"
(1067mm - 1372mm)
- D: 23" - 25 1/2"
(584mm - 648mm)
- W: 21"(533mm)
- SW: 19.2"(488mm)
- SD: 18"(457mm)

Features

- Outer Shells: Polypropylene or upholstered.
- Standard with hard casters; or optional soft casters or glides, see below.
- Mechanism: Swivel with synchronized-tilt.
- Height Adjustment: Pneumatic
- Optional Back-Lock: Lockable in two positions.
- Tilt tension.
- Optional Adjustable Air Lumbar: additional 1 1/2"(38mm) of lumbar support.
- Forward tilt not available on stools.
- Seat pan can be manually adjusted 3"(76mm).
- Foot ring adjustment: 6 1/2" - 15"
(165mm - 381mm).
- Foot ring available in chrome only; ring support black only; base cover will match trim color.
- Fire retardant construction is available to comply with California Bulletin #133, see below.
- COM yardage / COL square footage:
Polypropylene shell: 1.75/39
Upholstered shell: 2.25/45

To Order, Specify:

- 1) Product number.
- 2) Fabric surface and color.
(NOTE: For leather upholstery, see below.)
- 3) Trim color for shell, arms and base.

* All measurements taken with the BIFMA chair measuring device.

Shells	Arms/Caps	Number	Fabric Grade		C	D	E	F	G	H	Leather Grade A	Leather Grade B
			A	B								
Pneumatic Height Adjustment												
Polypropylene		M2E1-1042	\$1504.18	\$1582.32	\$1664.14	\$1705.06	\$1741.00	\$1812.96	\$1878.66	\$2060.96	\$2187.42	\$2374.58
Upholstered		M2E1-2042	1633.15	1711.29	1793.11	1834.03	1869.97	1941.93	2007.63	2189.93	2550.77	2737.93
Pneumatic Height Adjustment/Back-Lock												
Polypropylene		M2E1-1041	\$1557.51	\$1635.65	\$1717.47	\$1758.39	\$1794.33	\$1866.29	\$1931.99	\$2114.29	\$2240.75	\$2427.91
Upholstered		M2E1-2041	1686.48	1764.62	1846.44	1887.36	1923.30	1995.26	2060.96	2243.26	2604.10	2791.26
Pneumatic Height Adjustment with Adjustable Air Lumbar												
Polypropylene		M2E1-1044	\$1633.15	\$1711.29	\$1793.11	\$1834.03	\$1869.97	\$1941.93	\$2007.63	\$2189.93	\$2316.39	\$2503.55
Upholstered		M2E1-2044	1762.12	1840.26	1922.08	1963.00	1998.94	2070.90	2136.60	2318.90	2679.74	2866.90
Pneumatic Height Adjustment/Back-Lock with Adjustable Air Lumbar												
Polypropylene		M2E1-1043	\$1686.48	\$1764.62	\$1846.44	\$1887.36	\$1923.30	\$1995.26	\$2060.96	\$2243.26	\$2369.72	\$2556.88
Upholstered		M2E1-2043	1815.45	1893.59	1975.41	2016.33	2052.27	2124.23	2189.93	2372.23	2733.07	2920.23

The following options require modification of the product number.

- Glides
- Soft casters
- Faux Leather upholstery
- Leather upholstery
- CAL 133
- Stain repellent

- To specify, change the 7th digit from a 4 to a 0; **Example:** M2E1-1002
- To specify, change the 7th digit from a 4 to a 2; **Example:** M2E1-1022
- To specify, change the 2nd digit from a 2 to a 3; **Example:** M3E1-1042
- To specify, change the 2nd digit from a 2 to a 1; **Example:** M1E1-1042
- To specify, add **-F** to the end of the product number; **Example:** M2E1-2042-F (add \$120.28 list)
- To specify, add **-P** to the end of the product number; **Example:** M2E1-1042-P (add \$39.68 list)

NOTE: CAL 133 is available on all fully upholstered models and chairs with black (TR-F) polypropylene shells backs.

For available fabrics, refer to surfaces.haworth.com.

Improv Series

Improv S.E. Mesh Back Chair without Arms



M235-3042

Dimensions*

- SH: 16" - 21"
(406mm - 533mm)
- H: 37" - 42"
(940mm-1067mm)
- D: 25" - 27.5"
(635mm- 699mm)
- W: 25"(635mm)
- SW: 19.2"(488mm)
- SD: 15.5" - 18"
(394mm - 457mm)

Two-stage seat height:
.7"(18mm) below
standard
1.9"(48mm) above
standard

Features

- Back: Soft mesh.
- Seat: Standard upholstered.
- Base: Five-star, high arc plastic base standard; optional steel base available.
- 3"(76mm) sliding seat pan.
- Casters: Standard with hard casters; or optional soft casters, see below.
- Mechanism: Swivel with synchronized-tilt.
- Height Adjustment: Pneumatic or pneumatic with two-stage or low-position seat height, see below.
- Optional Back-Lock: Lockable in 2 positions.
- Optional Lumbar provides 3"(76mm) of vertical and 1"(25mm) of depth adjustment, black trim only.
- Optional Forward Tilt: Lockable in 3 positions.
- Tilt tension.
- COM yardage / COL square footage:
Upholstered seat: 0.75/20

To Order, Specify:

- 1) Product number.
- 2) Fabric surface and color (seat).
- 3) Fabric surface and color (mesh back).
Black Mesh: WO-01
- 4) Trim color for base.

* All measurements taken with the BIFMA chair measuring device.

Seat	Number	A	Fabric Grade B	C	D	E	F	G	H	Leather Grade A	Leather Grade B
Pneumatic Height Adjustment											
Upholstered	M235-3042	\$1014.36	\$1092.49	\$1164.41	\$1215.25	\$1251.21	\$1272.30	\$1326.85	\$1479.38	\$1697.62	\$1884.75
Pneumatic Height Adjustment/Back-Lock											
Upholstered	M235-3041	\$1067.69	\$1145.82	\$1217.74	\$1268.58	\$1304.54	\$1325.63	\$1380.18	\$1532.71	\$1750.95	\$1938.08
Pneumatic Height Adjustment/Forward-Tilt											
Upholstered	M245-3042	\$1067.69	\$1145.82	\$1217.74	\$1268.58	\$1304.54	\$1325.63	\$1380.18	\$1532.71	\$1750.95	\$1938.08
Pneumatic Height/Lumbar											
Upholstered	M235-3044	\$1148.29	\$1226.42	\$1298.34	\$1349.18	\$1385.14	\$1406.23	\$1460.78	\$1613.31	\$1831.55	\$2018.68
Pneumatic Height/Back-Lock/Lumbar											
Upholstered	M235-3043	\$1201.62	\$1279.75	\$1351.67	\$1402.51	\$1438.47	\$1459.56	\$1514.11	\$1666.64	\$1884.88	\$2072.01
Pneumatic Height/Forward-Tilt/Lumbar											
Upholstered	M245-3044	\$1201.62	\$1279.75	\$1351.67	\$1402.51	\$1438.47	\$1459.56	\$1514.11	\$1666.64	\$1884.88	\$2072.01

The following options require modification of the product number.

- Low-position seat height - Plastic
- Pneumatic seat height - Plastic
- Two-stage seat height- HAB
- Steel base - Standard height
- Steel base - Low height
- Soft casters
- Faux Leather upholstery
- Leather upholstery
- Stain repellent

- To specify, change the 4th digit from a 5 to a 4; **Example:** M234-3042
- To specify, change the 4th digit from a 5 to a 1; **Example:** M231-3042
- To specify, change the 4th digit from a 5 to a 3; **Example:** M233-3042 (add \$105.40 list)
- To specify, change the 4th digit from a 5 to a 6; **Example:** M236-3042
- To specify, change the 4th digit from a 5 to a 7; **Example:** M237-3042
- To specify, change the 7th digit from a 4 to a 2; **Example:** M235-3022
- To specify, change the 2nd digit from a 2 to a 3; **Example:** M335-3042
- To specify, change the 2nd digit from a 2 to a 1; **Example:** M135-3042
- To specify, add -P to the end of the product number; **Example:** M235-3042-P (add \$39.68 list)

NOTE: Stain repellent on upholstered seat only.

For available fabrics, refer to surfaces.haworth.com.

This page intentionally blank

Improv Series

Improv S.E. Mesh-Back Chair with Task Arms



M235-3442

Dimensions*

SH: 16" - 21"
(406mm - 533mm)
H: 37" - 42"
(940mm-1067mm)
D: 25" - 27.5"
(635mm - 699mm)
W: 25"(635mm)
SW: 19.2"(488mm)
SD: 15.5" - 18"
(394mm - 457mm)
AH: 6.2" - 11.1"
(157mm - 282mm)

Two-stage seat height:
.7"(18mm) below
standard
1.9"(48mm) above
standard

Features

- Back: Soft mesh.
- Seat: Standard upholstered.
- Base: Five-star, high arc plastic base standard; optional steel base available.
- Arms: Standard, upholstered fabric or optional vinyl arm caps.
- 3"(76mm) sliding seat pan.
- Casters: Standard with hard casters; or optional soft casters, see page 225.
- Mechanism: Swivel with synchronized-tilt.
- Height Adjustment: Pneumatic or pneumatic with two-stage or low-position seat height, see page 225.
- Optional Back-Lock: Lockable in 2 positions.
- Optional Forward Tilt: Lockable in 3 positions.
- Tilt tension.
- COM yardage / COL square footage:
Upholstered seat/arms: 0.75/20

* All measurements taken with the BIFMA chair measuring device.

To Order, Specify:

- 1) Product number.
- 2) Fabric surface and color (seat/arm caps).
- 3) Fabric surface and color (mesh back).
Black Mesh: WO-01
- 4) Trim color for base.

Seat	Arms/Caps	Number	Fabric Grade		C	D	E	F	G	H	Leather Grade A	Leather Grade B
			A	B								
Pneumatic Height Adjustment												
Upholstered	Standard	M235-3442	\$1117.29	\$1195.42	\$1267.34	\$1318.18	\$1354.14	\$1375.23	\$1429.78	\$1582.31	\$1800.55	\$1987.68
	Upholstered	M235-3542	1170.62	1248.75	1320.67	1371.51	1407.47	1428.56	1483.11	1635.64	1853.88	2041.01
	Soft Black Vinyl	M235-3642	1170.62	1248.75	1320.67	1371.51	1407.47	1428.56	1483.11	1635.64	1853.88	2041.01
Pneumatic Height Adjustment/Back-Lock												
Upholstered	Standard	M235-3441	\$1170.62	\$1248.75	\$1320.67	\$1371.51	\$1407.47	\$1428.56	\$1483.11	\$1635.64	\$1853.88	\$2041.01
	Upholstered	M235-3541	1223.95	1302.08	1374.00	1424.84	1460.80	1481.89	1536.44	1688.97	1907.21	2094.34
	Soft Black Vinyl	M235-3641	1223.95	1302.08	1374.00	1424.84	1460.80	1481.89	1536.44	1688.97	1907.21	2094.34
Pneumatic Height Adjustment/Forward-Tilt												
Upholstered	Standard	M245-3442	\$1170.62	\$1248.75	\$1320.67	\$1371.51	\$1407.47	\$1428.56	\$1483.11	\$1635.64	\$1853.88	\$2041.01
	Upholstered	M245-3542	1223.95	1302.08	1374.00	1424.84	1460.80	1481.89	1536.44	1688.97	1907.21	2094.34
	Soft Black Vinyl	M245-3642	1223.95	1302.08	1374.00	1424.84	1460.80	1481.89	1536.44	1688.97	1907.21	2094.34

Improv Series

Improv S.E. Mesh-Back Chair with Task Arms

Seat	Arms/Caps	Number	Fabric Grade								Leather Grade A	Leather Grade B
			A	B	C	D	E	F	G	H		
Pneumatic Height/Lumbar												
Upholstered	Standard	M235-3444	\$1251.22	\$1329.35	\$1401.27	\$1452.11	\$1488.07	\$1509.16	\$1563.71	\$1716.24	\$1934.48	\$2121.61
	Upholstered	M235-3544	1304.55	1382.68	1454.60	1505.44	1541.40	1562.49	1617.04	1769.57	1987.81	2174.94
	Soft Black Vinyl	M235-3644	1304.55	1382.68	1454.60	1505.44	1541.40	1562.49	1617.04	1769.57	1987.81	2174.94
Pneumatic Height/Back-Lock/Lumbar												
Upholstered	Standard	M235-3443	\$1304.55	\$1382.68	\$1454.60	\$1505.44	\$1541.40	\$1562.49	\$1617.04	\$1769.57	\$1987.81	\$2174.94
	Upholstered	M235-3543	1357.88	1436.01	1507.93	1558.77	1594.73	1615.82	1670.37	1822.90	2041.14	2228.27
	Soft Black Vinyl	M235-3643	1357.88	1436.01	1507.93	1558.77	1594.73	1615.82	1670.37	1822.90	2041.14	2228.27
Pneumatic Height/Forward-Tilt/Lumbar												
Upholstered	Standard	M245-3444	\$1304.55	\$1382.68	\$1454.60	\$1505.44	\$1541.40	\$1562.49	\$1617.04	\$1769.57	\$1987.81	\$2174.94
	Upholstered	M245-3544	1357.88	1436.01	1507.93	1558.77	1594.73	1615.82	1670.37	1822.90	2041.14	2228.27
	Soft Black Vinyl	M245-3644	1357.88	1436.01	1507.93	1558.77	1594.73	1615.82	1670.37	1822.90	2041.14	2228.27

The following options require modification of the product number.

Low-position seat height - Plastic
Pneumatic seat height - Plastic
Two-stage seat height- HAB
Steel base - Standard height
Steel base - Low height
Soft casters
Faux Leather upholstery
Leather upholstery
Stain repellent

To specify, change the 4th digit from a 5 to a 4; **Example:** M234-3442
To specify, change the 4th digit from a 5 to a 1; **Example:** M231-3442
To specify, change the 4th digit from a 5 to a 3; **Example:** M233-3442 (add \$105.40 list)
To specify, change the 4th digit from a 5 to a 6; **Example:** M236-3442
To specify, change the 4th digit from a 5 to a 7; **Example:** M237-3442
To specify, change the 7th digit from a 4 to a 2; **Example:** M235-3422
To specify, change the 2nd digit from a 2 to a 3; **Example:** M335-3442
To specify, change the 2nd digit from a 2 to a 1; **Example:** M135-3442
To specify, add -P to the end of the product number; **Example:** M235-3442-P (add \$39.68 list)

NOTE: Stain repellent on upholstered seat only.

For available fabrics, refer to surfaces.haworth.com.

Improv Series

Improv S.E. Mesh-Back Chair with Height Adjustable Task Arms



M235-3742

Dimensions*

SH: 16" - 21"
(406mm - 533mm)
H: 37" - 42"
(940mm-1067mm)
D: 25" - 27.5"
(635mm- 699mm)
W: 25"(635mm)
SW: 19.2"(488mm)
SD: 15.5" - 18"
(394mm - 457mm)
AH: 6.2" - 11.1"
(157mm - 282mm)

Two-stage seat height:
.7"(18mm) below
standard
1.9"(48mm) above
standard

Features

- Back: Soft mesh.
- Seat: Standard upholstered.
- Base: Five-star, high arc plastic base standard; optional steel base available.
- Arms: Standard, upholstered fabric or optional vinyl arm caps.
- Arm Adjustment Controls: Fingertip activation.
- Arm Adjustment: 4"(102mm) height adjustment.
- 3"(76mm) sliding seat pan.
- Casters: Standard with hard casters; or optional soft casters, see page 227.
- Mechanism: Swivel with synchronized-tilt.
- Height Adjustment: Pneumatic or pneumatic with two-stage or low-position seat height, see page 227.
- Optional Back-Lock: Lockable in 2 positions.
- Optional Forward Tilt: Lockable in 3 positions.
- Tilt tension.
- COM yardage / COL square footage:
Upholstered seat: 0.75/20

* All measurements taken with the BIFMA chair measuring device.

To Order, Specify:

- 1) Product number.
- 2) Fabric surface and color (seat/arm caps).
- 3) Fabric surface and color (mesh back).
Black Mesh: WO-01
- 4) Trim color for base.

Seat	Arms/Caps	Number	Fabric Grade		C	D	E	F	G	H	Leather Grade A	Leather Grade B
			A	B								
Pneumatic Height Adjustment												
Upholstered	Standard	M235-3742	\$1231.37	\$1309.50	\$1381.42	\$1432.26	\$1468.22	\$1489.31	\$1543.86	\$1696.39	\$1914.63	\$2101.76
	Upholstered	M235-3842	1284.70	1362.83	1434.75	1485.59	1521.55	1542.64	1597.19	1749.72	1967.96	2155.09
	Soft Black Vinyl	M235-3942	1284.70	1362.83	1434.75	1485.59	1521.55	1542.64	1597.19	1749.72	1967.96	2155.09
Pneumatic Height Adjustment/Back-Lock												
Upholstered	Standard	M235-3741	\$1284.70	\$1362.83	\$1434.75	\$1485.59	\$1521.55	\$1542.64	\$1597.19	\$1749.72	\$1967.96	\$2155.09
	Upholstered	M235-3841	1338.03	1416.16	1488.08	1538.92	1574.88	1595.97	1650.52	1803.05	2021.29	2208.42
	Soft Black Vinyl	M235-3941	1338.03	1416.16	1488.08	1538.92	1574.88	1595.97	1650.52	1803.05	2021.29	2208.42
Pneumatic Height Adjustment/Forward-Tilt												
Upholstered	Standard	M245-3742	\$1284.70	\$1362.83	\$1434.75	\$1485.59	\$1521.55	\$1542.64	\$1597.19	\$1749.72	\$1967.96	\$2155.09
	Upholstered	M245-3842	1338.03	1416.16	1488.08	1538.92	1574.88	1595.97	1650.52	1803.05	2021.29	2208.42
	Soft Black Vinyl	M245-3942	1338.03	1416.16	1488.08	1538.92	1574.88	1595.97	1650.52	1803.05	2021.29	2208.42

Improv Series

Improv S.E. Mesh-Back Chair with Height Adjustable Task Arms

Seat	Arms/Caps	Number	Fabric Grade								Leather Grade A	Leather Grade B
			A	B	C	D	E	F	G	H		
Pneumatic Height/Lumbar												
Upholstered	Standard	M235-3744	\$1365.30	\$1443.43	\$1515.35	\$1566.19	\$1602.15	\$1623.24	\$1677.79	\$1830.32	\$2048.56	\$2235.69
	Upholstered	M235-3844	1418.63	1496.76	1568.68	1619.52	1655.48	1676.57	1731.12	1883.65	2101.89	2289.02
	Soft Black Vinyl	M235-3944	1418.63	1496.76	1568.68	1619.52	1655.48	1676.57	1731.12	1883.65	2101.89	2289.02
Pneumatic Height/Back-Lock/Lumbar												
Upholstered	Standard	M235-3743	\$1418.63	\$1496.76	\$1568.68	\$1619.52	\$1655.48	\$1676.57	\$1731.12	\$1883.65	\$2101.89	\$2289.02
	Upholstered	M235-3843	1471.96	1550.09	1622.01	1672.85	1708.81	1729.90	1784.45	1936.98	2155.22	2342.35
	Soft Black Vinyl	M235-3943	1471.96	1550.09	1622.01	1672.85	1708.81	1729.90	1784.45	1936.98	2155.22	2342.35
Pneumatic Height/Forward-Tilt/Lumbar												
Upholstered	Standard	M245-3744	\$1418.63	\$1496.76	\$1568.68	\$1619.52	\$1655.48	\$1676.57	\$1731.12	\$1883.65	\$2101.89	\$2289.02
	Upholstered	M245-3844	1471.96	1550.09	1622.01	1672.85	1708.81	1729.90	1784.45	1936.98	2155.22	2342.35
	Soft Black Vinyl	M245-3944	1471.96	1550.09	1622.01	1672.85	1708.81	1729.90	1784.45	1936.98	2155.22	2342.35

The following options require modification of the product number.

Low-position seat height - Plastic	To specify, change the 4th digit from a 5 to a 4; Example: M234-3742
Pneumatic seat height - Plastic	To specify, change the 4th digit from a 5 to a 1; Example: M231-3742
Two-stage seat height - HAB	To specify, change the 4th digit from a 5 to a 3; Example: M233-3742 (add \$105.40 list)
Steel base - Standard height	To specify, change the 4th digit from a 5 to a 6; Example: M236-3742
Steel base - Low height	To specify, change the 4th digit from a 5 to a 7; Example: M237-3742
Soft casters	To specify, change the 7th digit from a 4 to a 2; Example: M235-3722
Faux Leather upholstery	To specify, change the 2nd digit from a 2 to a 3; Example: M335-3742
Leather upholstery	To specify, change the 2nd digit from a 2 to a 1; Example: M135-3742
Stain repellent	To specify, add -P to the end of the product number; Example: M235-3742-P (add \$39.68 list)

NOTE: Stain repellent on upholstered seat only.

For available fabrics, refer to surfaces.haworth.com.

Improv Series

Improv S.E. Mesh-Back Chair with Flipper Arms



M235-3H42

Dimensions*

- SH: 16" - 21"
(406mm - 533mm)
- H: 37" - 42"
(940mm-1067mm)
- D: 25" - 27.5"
(635mm- 699mm)
- W: 25"(635mm)
- SW: 19.2"(488mm)
- SD: 15.5" - 18"
(394mm - 457mm)
- AH: 6.2" - 11.1"
(157mm - 282mm)

Two-stage seat height:
.7"(18mm) below
standard
1.9"(48mm) above
standard

* All measurements
taken with the
BIFMA chair
measuring device.

Features

- Back: Soft mesh.
- Seat: Standard upholstered.
- Base: Five-star, high arc plastic base standard; optional steel base available.
- Arms: Standard, upholstered fabric or optional vinyl arm caps.
- Arm Adjustment Controls: Fingertip activation.
- Arm Adjustment: 5"(127mm) height adjustment.
- Arm Pad Rotation: 350°.
- 3"(76mm) sliding seat pan.
- Casters: Standard with hard casters; or optional soft casters, see page 229.
- Mechanism: Swivel with synchronized-tilt.
- Height Adjustment: Pneumatic or pneumatic with two-stage or low-position seat height, see page 229.
- Optional Back-Lock: Lockable in 2 positions.
- Optional Forward Tilt: Lockable in 3 positions.
- Tilt tension.
- COM yardage / COL square footage:
Upholstered seat: 0.75/20

To Order, Specify:

- 1) Product number.
- 2) Fabric surface and color (seat/arm caps).
- 3) Fabric surface and color (mesh back).
Black Mesh: WO-01
- 4) Trim color for base.

Seat	Arms/Caps	Number	Fabric Grade								Leather Grade A	Leather Grade B
			A	B	C	D	E	F	G	H		
Pneumatic Height Adjustment												
Upholstered	Standard	M235-3H42	\$1457.05	\$1535.18	\$1607.10	\$1657.94	\$1693.90	\$1714.99	\$1769.54	\$1922.07	\$2140.31	\$2327.44
	Vinyl Gel	M235-3G42	1528.99	1607.12	1679.04	1729.88	1765.84	1786.93	1841.48	1994.01	2212.25	2399.38
	Upholstered	M235-3U42	1582.32	1660.45	1732.37	1783.21	1819.17	1840.26	1894.81	2047.34	2265.58	2452.71
Pneumatic Height Adjustment/Back-Lock												
Upholstered	Standard	M235-3H41	\$1510.38	\$1588.51	\$1660.43	\$1711.27	\$1747.23	\$1768.32	\$1822.87	\$1975.40	\$2193.64	\$2380.77
	Vinyl Gel	M235-3G41	1582.32	1660.45	1732.37	1783.21	1819.17	1840.26	1894.81	2047.34	2265.58	2452.71
	Upholstered	M235-3U41	1635.65	1713.78	1785.70	1836.54	1872.50	1893.59	1948.14	2100.67	2318.91	2506.04
Pneumatic Height Adjustment/Forward-Tilt												
Upholstered	Standard	M245-3H42	\$1510.38	\$1588.51	\$1660.43	\$1711.27	\$1747.23	\$1768.32	\$1822.87	\$1975.40	\$2193.64	\$2380.77
	Vinyl Gel	M245-3G42	1582.32	1660.45	1732.37	1783.21	1819.17	1840.26	1894.81	2047.34	2265.58	2452.71
	Upholstered	M245-3U42	1635.65	1713.78	1785.70	1836.54	1872.50	1893.59	1948.14	2100.67	2318.91	2506.04

Improv Series

Improv S.E. Mesh-Back Chair with Flipper Arms

Seat	Arms/Caps	Number	Fabric Grade								Leather Grade A	Leather Grade B
			A	B	C	D	E	F	G	H		
Pneumatic Height/Lumbar												
Upholstered	Standard	M235-3H44	\$1590.98	\$1669.11	\$1741.03	\$1791.87	\$1827.83	\$1848.92	\$1903.47	\$2056.00	\$2274.24	\$2461.37
	Vinyl Gel	M235-3G44	1662.92	1741.05	1812.97	1863.81	1899.77	1920.86	1975.41	2127.94	2346.18	2533.31
	Upholstered	M235-3U44	1716.25	1794.38	1866.30	1917.14	1953.10	1974.19	2028.74	2181.27	2399.51	2586.64
Pneumatic Height/Back-Lock/Lumbar												
Upholstered	Standard	M235-3H43	\$1644.31	\$1722.44	\$1794.36	\$1845.20	\$1881.16	\$1902.25	\$1956.80	\$2109.33	\$2327.57	\$2514.70
	Vinyl Gel	M235-3G43	1716.25	1794.38	1866.30	1917.14	1953.10	1974.19	2028.74	2181.27	2399.51	2586.64
	Upholstered	M235-3U43	1769.58	1847.71	1919.63	1970.47	2006.43	2027.52	2082.07	2234.60	2452.84	2639.97
Pneumatic Height/Forward-Tilt/Lumbar												
Upholstered	Standard	M245-3H44	\$1644.31	\$1722.44	\$1794.36	\$1845.20	\$1881.16	\$1902.25	\$1956.80	\$2109.33	\$2327.57	\$2514.70
	Vinyl Gel	M245-3G44	1716.25	1794.38	1866.30	1917.14	1953.10	1974.19	2028.74	2181.27	2399.51	2586.64
	Upholstered	M245-3U44	1769.58	1847.71	1919.63	1970.47	2006.43	2027.52	2082.07	2234.60	2452.84	2639.97

The following options require modification of the product number.

Low-position seat height - Plastic
Pneumatic seat height - Plastic
Two-stage seat height- HAB
Steel base - Standard height
Steel base - Low height
Soft casters
Faux Leather upholstery
Leather upholstery
Stain repellent

To specify, change the 4th digit from a 5 to a 4; **Example:** M234-3H42
To specify, change the 4th digit from a 5 to a 1; **Example:** M231-3H42
To specify, change the 4th digit from a 5 to a 3; **Example:** M233-3H42 (add \$105.40 list)
To specify, change the 4th digit from a 5 to a 6; **Example:** M236-3H42
To specify, change the 4th digit from a 5 to a 7; **Example:** M237-3H42
To specify, change the 7th digit from a 4 to a 2; **Example:** M235-3H22
To specify, change the 2nd digit from a 2 to a 3; **Example:** M335-3H42
To specify, change the 2nd digit from a 2 to a 1; **Example:** M135-3H42
To specify, add -P to the end of the product number; **Example:** M235-3H42-P (add \$39.68 list)

NOTE: Stain repellent on upholstered seat only.

For available fabrics, refer to surfaces.haworth.com.

Improv Series

Improv S.E. Mesh-Back Chair with Height and Width Adjustable 3-D Arms



M235-3W42

Dimensions*

- SH: 16" - 21"
(406mm - 533mm)
- H: 37" - 42"
(940mm-1067mm)
- D: 25" - 27.5"
(635mm- 699mm)
- W: 25"(635mm)
- SW: 19.2"(488mm)
- SD: 15.5" - 18"
(394mm - 457mm)
- AH: 6.2" - 11.1"
(157mm - 282mm)

Two-stage seat height:
.7"(18mm) below
standard
1.9"(48mm) above
standard

Features

- Back: Soft mesh.
- Seat: Standard upholstered.
- Base: Five-star, high arc plastic base standard: optional steel base available.
- Arms: Molded black vinyl arm caps.
- Arm Adjustment Controls: Fingertip activation.
- Arm Adjustment: 4"(102mm) height adjustment.
- Arm Width Adjustment: 1 1/2"(38mm) each arm in-out adjustment.
- 3"(76mm) sliding seat pan.
- Casters: Standard with hard casters; or optional soft casters, see below.
- Mechanism: Swivel with synchronized-tilt.
- Height Adjustment: Pneumatic or pneumatic with two-stage or low-position seat height, see below.
- Optional Back-Lock: Lockable in 2 positions.
- Optional Forward Tilt: Lockable in 3 positions.
- Tilt tension.
- COM yardage / COL square footage:
Upholstered seat: 0.75/20

To Order, Specify:

- 1) Product number.
- 2) Fabric surface and color (seat).
- 3) Fabric surface and color (mesh back).
Black Mesh: WO-01
- 4) Trim color for base.

* All measurements taken with the BIFMA chair measuring device.

Seat	Arms/Caps	Number	Fabric Grade								Leather Grade A	Leather Grade B
			A	B	C	D	E	F	G	H		
Pneumatic Height Adjustment												
Upholstered	Molded Black Vinyl	M235-3W42	\$1372.73	\$1450.86	\$1522.78	\$1573.62	\$1609.58	\$1630.67	\$1685.22	\$1837.75	\$2055.99	\$2243.12
Pneumatic Height Adjustment/Back-Lock												
Upholstered	Molded Black Vinyl	M235-3W41	\$1426.06	\$1504.19	\$1576.11	\$1626.95	\$1662.91	\$1684.00	\$1738.55	\$1891.08	\$2109.32	\$2296.45
Pneumatic Height Adjustment/Forward-Tilt												
Upholstered	Molded Black Vinyl	M245-3W42	\$1426.06	\$1504.19	\$1576.11	\$1626.95	\$1662.91	\$1684.00	\$1738.55	\$1891.08	\$2109.32	\$2296.45
Pneumatic Height/Lumbar												
Upholstered	Molded Black Vinyl	M235-3W44	\$1506.66	\$1584.79	\$1656.71	\$1707.55	\$1743.51	\$1764.60	\$1819.15	\$1971.68	\$2189.92	\$2377.05
Pneumatic Height/Back-Lock/Lumbar												
Upholstered	Molded Black Vinyl	M235-3W43	\$1559.99	\$1638.12	\$1710.04	\$1760.88	\$1796.84	\$1817.93	\$1872.48	\$2025.01	\$2243.25	\$2430.38
Pneumatic Height/Forward-Tilt/Lumbar												
Upholstered	Molded Black Vinyl	M245-3W44	\$1559.99	\$1638.12	\$1710.04	\$1760.88	\$1796.84	\$1817.93	\$1872.48	\$2025.01	\$2243.25	\$2430.38

The following options require modification of the product number.

- Low-position seat height - Plastic
- Pneumatic seat height - Plastic
- Two-stage seat height- HAB
- Steel base - Standard height
- Steel base - Low height
- Soft casters
- Faux Leather upholstery
- Leather upholstery
- Stain repellent

- To specify, change the 4th digit from a 5 to a 4; **Example:** M234-3W42
- To specify, change the 4th digit from a 5 to a 1; **Example:** M231-3W42
- To specify, change the 4th digit from a 5 to a 3; **Example:** M233-3W42 (add \$105.40 list)
- To specify, change the 4th digit from a 5 to a 6; **Example:** M236-3W42
- To specify, change the 4th digit from a 5 to a 7; **Example:** M237-3W42
- To specify, change the 7th digit from a 4 to a 2; **Example:** M235-3W22
- To specify, change the 2nd digit from a 2 to a 3; **Example:** M335-3W42
- To specify, change the 2nd digit from a 2 to a 1; **Example:** M135-3W42
- To specify, add -P to the end of the product number; **Example:** M235-3W42-P (add \$39.68 list)

NOTE: Stain repellent on upholstered seat only.

For available fabrics, refer to surfaces.haworth.com.

Improv Tag

General Specifications

Features and Options

All Improv Tag chairs feature:

- Molded-polyfoam contoured seat
- Mesh "form-fit" back
- Five-star plastic high arc base with black casters
- Hard dual-wheel casters (standard) or soft dual-wheel casters (optional)
- Pneumatic seat height adjustment
- Task arms, height-adjustable task arms, 3-D arms or armless
- Tilt tension
- Optional low-position seat height adjustment with steel base
- Optional back-lock
 - Back and seat recline at a 2:1 ration with no front seat rise
 - Back is lockable in two positions within tilt range
 - Back tilts backward 20 degrees from the upright position
 - Seat pan moves downward 10 degrees from the initial position
 - Back-lock and forward-tilt options cannot be specified on the same chair
- Optional forward-tilt
 - Both chair back and seat pan are lockable in three forward positions (1, 3 and 5 degrees)
 - Forward-tilt and back-lock options cannot be specified on the same chair
- Optional height and depth adjustable lumbar

COM & COL General Information

To order a COM fabric (Customer's Own Material), contact the Haworth Inquiry Center (1.800.426.8562), your local Haworth dealer, or go to haworth.com/surfaces > COM Library to find out if the COM you have selected has already been tested and approved. The surface collection site also has information on the Haworth+ alliance program with Carnegie, Luna Textiles, and Maharam as well as our industry-leading Pre-Approved COM program.

COM fabrics are placed into Grades based on the cost per linear yard. If a fabric's cost exceeds the range of our highest Grade it will be noted as Non-Graded. The product will be priced at Grade A; the COM fabric costs will appear as a separate line item. The fabric charge will be Haworth's purchase cost plus a 4% administrative fee (based on the cost of the fabric). Yardage calculations will include any applicable fabric repeat.

COM Leather products will be priced at a leather Grade A; COL costs will appear as a separate line item. The leather costs will be Haworth's purchase cost plus a 4% administrative fee (based on the cost of the leather).

General Guidelines for Product Specification

The alpha-numeric logic for an Improv Tag chair complete with fabric and finish codes is shown below:

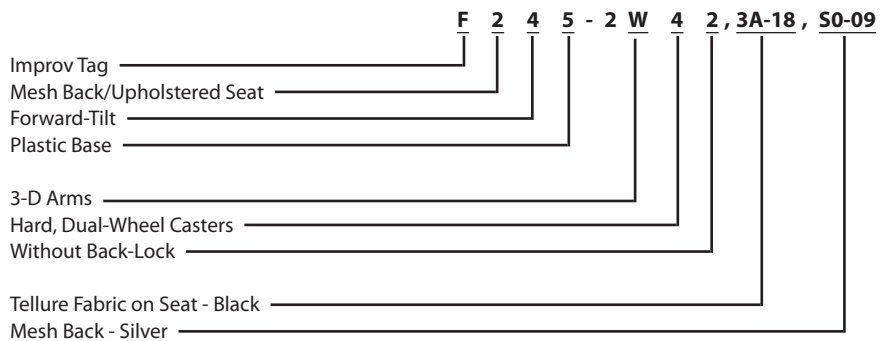

Improv Tag

Mesh Back without Arms



F235-2042

Dimensions

- SH: 16" - 21"
(406mm-533mm)
- H: 37" - 42"
(940mm-1067mm)
- D: 25" - 27 1/2"
(635mm-699mm)
- W: 25"(635mm)
- SW: 20"(508mm)
- SD: 15 1/2" - 18"
(394mm-457mm)

Features

- Soft mesh back.
- Upholstered seat.
- Pneumatic height adjustment.
- Sliding seat.
- Tilt tension.
- Standard with hard casters; optional soft casters available.
- Standard with five-star high arc plastic base; optional steel base available.
- Optional back-lock.
- Optional lumbar adjustment.
- Optional forward-tilt.
- Optional low-position seat height/steel base.
- COM yardage / COL square footage:
Upholstered Seat: 0.75/20.0

To Order, Specify:

- 1) Product number.
- 2) Seat fabric.
- 3) Mesh back fabric.
TR-F Black trim (no need to specify).

Description	Number	Fabric Grade								Leather Grade A	Leather Grade B
		A	B	C	D	E	F	G	H		
Pneumatic Height	F235-2042	\$1097.44	\$1175.57	\$1247.49	\$1298.33	\$1334.29	\$1355.38	\$1409.93	\$1562.46	\$1780.70	\$1967.83
Pneumatic Height/Back-Lock	F235-2041	1154.48	1232.61	1304.53	1355.37	1391.33	1412.42	1466.97	1619.50	1837.74	2024.87
Pneumatic Height/Back-Lock/Lumbar	F235-2043	1285.93	1364.06	1435.98	1486.82	1522.78	1543.87	1598.42	1750.95	1969.19	2156.32
Pneumatic Height/Lumbar	F235-2044	1228.89	1307.02	1378.94	1429.78	1465.74	1486.83	1541.38	1693.91	1912.15	2099.28
Pneumatic Height/Forward-Tilt	F245-2042	1153.25	1231.38	1303.30	1354.14	1390.10	1411.19	1465.74	1618.27	1836.51	2023.64
Pneumatic Height/Forward-Tilt/Lumbar	F245-2044	1284.70	1362.83	1434.75	1485.59	1521.55	1542.64	1597.19	1749.72	1967.96	2155.09

The following options require modification of the product number.

- Low position seat height/plastic base To specify, change the 4th digit from a 5 to a 4; **Example:** F234-2042
- Steel base - Low height To specify, change the 4th digit from a 5 to a 7; **Example:** F237-2042
- Soft casters To specify, change the 7th digit from a 4 to a 2; **Example:** F235-2022
- Faux Leather seat To specify, change the 2nd digit from a 2 to a 3; **Example:** F335-2042
- Leather seat To specify, change the 2nd digit from a 2 to a 1; **Example:** F135-2042
- CAL 133 To specify, add -F to the end of the product number; **Example:** F235-2042-F (add \$120.28 list)
- Stain repellent To specify, add -P to the end of the product number; **Example:** F235-2042-P (add \$39.68 list)

NOTE: Stain repellent on upholstered seat only.

For available fabrics, refer to surfaces.haworth.com.

Improv Tag

Mesh Back with Fixed-Height Task Arms



F235-2442

Dimensions

- SH: 16" - 21"
(406mm-533mm)
- H: 37" - 42"
(940mm-1067mm)
- D: 25" - 27 1/2"
(635mm-699mm)
- W: 25"(635mm)
- SW: 20"(508mm)
- SD: 15 1/2" - 18"
(394mm-457mm)

Features

- Soft mesh back.
- Upholstered seat.
- Pneumatic height adjustment.
- Fixed-height task arms.
- Sliding seat.
- Tilt tension.
- Standard with hard casters; optional soft casters available.
- Standard with five-star high arc plastic base; optional steel base available.
- Optional back-lock.
- Optional lumbar adjustment.
- Optional forward-tilt.
- Optional low position seat height/steel base.
- COM yardage / COL square footage:
Upholstered Seat: 0.75/20.0

To Order, Specify:

- 1) Product number.
- 2) Seat fabric.
- 3) Mesh back fabric.
TR-F Black trim (no need to specify).

Description	Arm Cap	Number	Fabric Grade		C	D	E	F	G	H	Leather Grade A	Leather Grade B
			A	B								
Pneumatic Height												
Standard		F235-2442	\$1207.80	\$1285.93	\$1357.85	\$1408.69	\$1444.65	\$1465.74	\$1520.29	\$1672.82	\$1891.06	\$2078.19
Upholstered		F235-2542	1267.32	1345.45	1417.37	1468.21	1504.17	1525.26	1579.81	1732.34	1950.58	2137.71
Vinyl		F235-2642	1267.32	1345.45	1417.37	1468.21	1504.17	1525.26	1579.81	1732.34	1950.58	2137.71
Pneumatic Height/Back-Lock												
Standard		F235-2441	\$1264.84	\$1342.97	\$1414.89	\$1465.73	\$1501.69	\$1522.78	\$1577.33	\$1729.86	\$1948.10	\$2135.23
Upholstered		F235-2541	1324.36	1402.49	1474.41	1525.25	1561.21	1582.30	1636.85	1789.38	2007.62	2194.75
Vinyl		F235-2641	1324.36	1402.49	1474.41	1525.25	1561.21	1582.30	1636.85	1789.38	2007.62	2194.75
Pneumatic Height/Back-Lock/Lumbar												
Standard		F235-2443	\$1396.29	\$1474.42	\$1546.34	\$1597.18	\$1633.14	\$1654.23	\$1708.78	\$1861.31	\$2079.55	\$2266.68
Upholstered		F235-2543	1455.81	1533.94	1605.86	1656.70	1692.66	1713.75	1768.30	1920.83	2139.07	2326.20
Vinyl		F235-2643	1455.81	1533.94	1605.86	1656.70	1692.66	1713.75	1768.30	1920.83	2139.07	2326.20
Pneumatic Height/Lumbar												
Standard		F235-2444	\$1339.25	\$1417.38	\$1489.30	\$1540.14	\$1576.10	\$1597.19	\$1651.74	\$1804.27	\$2022.51	\$2209.64
Upholstered		F235-2544	1398.77	1476.90	1548.82	1599.66	1635.62	1656.71	1711.26	1863.79	2082.03	2269.16
Vinyl		F235-2644	1398.77	1476.90	1548.82	1599.66	1635.62	1656.71	1711.26	1863.79	2082.03	2269.16
Pneumatic Height/Forward-Tilt												
Standard		F245-2442	\$1263.61	\$1341.74	\$1413.66	\$1464.50	\$1500.46	\$1521.55	\$1576.10	\$1728.63	\$1946.87	\$2134.00
Upholstered		F245-2542	1323.13	1401.26	1473.18	1524.02	1559.98	1581.07	1635.62	1788.15	2006.39	2193.52
Vinyl		F245-2642	1323.13	1401.26	1473.18	1524.02	1559.98	1581.07	1635.62	1788.15	2006.39	2193.52
Pneumatic Height/Forward-Tilt/Lumbar												
Standard		F245-2444	\$1395.06	\$1473.19	\$1545.11	\$1595.95	\$1631.91	\$1653.00	\$1707.55	\$1860.08	\$2078.32	\$2265.45
Upholstered		F245-2544	1454.58	1532.71	1604.63	1655.47	1691.43	1712.52	1767.07	1919.60	2137.84	2324.97
Vinyl		F245-2644	1454.58	1532.71	1604.63	1655.47	1691.43	1712.52	1767.07	1919.60	2137.84	2324.97

The following options require modification of the product number.

- Low position seat height/plastic base
- Steel base - Low height
- Soft casters
- Faux Leather seat
- Leather seat
- CAL 133
- Stain repellent

- To specify, change the 4th digit from a 5 to a 4; **Example:** F234-2543
- To specify, change the 4th digit from a 5 to a 7; **Example:** F237-2543
- To specify, change the 7th digit from a 4 to a 2; **Example:** F235-2522
- To specify, change the 2nd digit from a 2 to a 3; **Example:** F345-2644
- To specify, change the 2nd digit from a 2 to a 1; **Example:** F135-2544
- To specify, add **-F** to the end of the product number; **Example:** F235-2442-F (add \$120.28 list)
- To specify, add **-P** to the end of the product number; **Example:** F235-2442-P (add \$39.68 list)

NOTE: Stain repellent on upholstered seat only.

For available fabrics, refer to surfaces.haworth.com.

Improv Tag

Mesh Back with Height-Adjustable Task Arms



F235-2742

Dimensions

SH: 16" - 21"
(406mm-533mm)
H: 37" - 42"
(940mm-1067mm)
D: 25" - 27 1/2"
(635mm-699mm)
W: 25"(635mm)
SW: 20"(508mm)
SD: 15 1/2" - 18"
(394mm-457mm)

Features

- Soft mesh back.
- Upholstered seat.
- Pneumatic height adjustment.
- Height-adjustable task arms.
- Sliding seat.
- Tilt tension.
- Standard with hard casters; optional soft casters available.
- Standard with five-star high arc plastic base; optional steel base available.
- Optional back-lock.
- Optional lumbar adjustment.
- Optional forward-tilt.
- Optional low position seat height/steel base.
- COM yardage / COL square footage:
Upholstered Seat: 0.75/20.0

To Order, Specify:

- 1) Product number.
- 2) Seat fabric.
- 3) Mesh back fabric.
TR-F Black trim (no need to specify).

Description	Arm Cap	Number	Fabric Grade		C	D	E	F	G	H	Leather Grade A	Leather Grade B
			A	B								
Pneumatic Height												
Standard		F235-2742	\$1330.58	\$1408.71	\$1480.63	\$1531.47	\$1567.43	\$1588.52	\$1643.07	\$1795.60	\$2013.84	\$2200.97
Upholstered		F235-2842	1390.10	1468.23	1540.15	1590.99	1626.95	1648.04	1702.59	1855.12	2073.36	2260.49
Vinyl		F235-2942	1390.10	1468.23	1540.15	1590.99	1626.95	1648.04	1702.59	1855.12	2073.36	2260.49
Pneumatic Height/Back-Lock												
Standard		F235-2741	\$1387.62	\$1465.75	\$1537.67	\$1588.51	\$1624.47	\$1645.56	\$1700.11	\$1852.64	\$2070.88	\$2258.01
Upholstered		F235-2841	1447.14	1525.27	1597.19	1648.03	1683.99	1705.08	1759.63	1912.16	2130.40	2317.53
Vinyl		F235-2941	1447.14	1525.27	1597.19	1648.03	1683.99	1705.08	1759.63	1912.16	2130.40	2317.53
Pneumatic Height/Back-Lock/Lumbar												
Standard		F235-2743	\$1519.07	\$1597.20	\$1669.12	\$1719.96	\$1755.92	\$1777.01	\$1831.56	\$1984.09	\$2202.33	\$2389.46
Upholstered		F235-2843	1578.59	1656.72	1728.64	1779.48	1815.44	1836.53	1891.08	2043.61	2261.85	2448.98
Vinyl		F235-2943	1578.59	1656.72	1728.64	1779.48	1815.44	1836.53	1891.08	2043.61	2261.85	2448.98
Pneumatic Height/Lumbar												
Standard		F235-2744	\$1462.03	\$1540.16	\$1612.08	\$1662.92	\$1698.88	\$1719.97	\$1774.52	\$1927.05	\$2145.29	\$2332.42
Upholstered		F235-2844	1521.55	1599.68	1671.60	1722.44	1758.40	1779.49	1834.04	1986.57	2204.81	2391.94
Vinyl		F235-2944	1521.55	1599.68	1671.60	1722.44	1758.40	1779.49	1834.04	1986.57	2204.81	2391.94
Pneumatic Height/Forward-Tilt												
Standard		F245-2742	\$1386.39	\$1464.52	\$1536.44	\$1587.28	\$1623.24	\$1644.33	\$1698.88	\$1851.41	\$2069.65	\$2256.78
Upholstered		F245-2842	1445.91	1524.04	1595.96	1646.80	1682.76	1703.85	1758.40	1910.93	2129.17	2316.30
Vinyl		F245-2942	1445.91	1524.04	1595.96	1646.80	1682.76	1703.85	1758.40	1910.93	2129.17	2316.30
Pneumatic Height/Forward-Tilt/Lumbar												
Standard		F245-2744	\$1517.84	\$1595.97	\$1667.89	\$1718.73	\$1754.69	\$1775.78	\$1830.33	\$1982.86	\$2201.10	\$2388.23
Upholstered		F245-2844	1577.36	1655.49	1727.41	1778.25	1814.21	1835.30	1889.85	2042.38	2260.62	2447.75
Vinyl		F245-2944	1577.36	1655.49	1727.41	1778.25	1814.21	1835.30	1889.85	2042.38	2260.62	2447.75

The following options require modification of the product number.

Low position seat height/plastic base
Steel base - Low height
Soft casters
Faux Leather seat
Leather seat
Stain repellent

To specify, change the 4th digit from a 5 to a 4; **Example:** F234-2843
To specify, change the 4th digit from a 5 to a 7; **Example:** F237-2843
To specify, change the 7th digit from a 4 to a 2; **Example:** F235-2822
To specify, change the 2nd digit from a 2 to a 3; **Example:** F345-2944
To specify, change the 2nd digit from a 2 to a 1; **Example:** F135-2844
To specify, add -P to the end of the product number; **Example:** F235-2742-P (add \$39.68 list)

NOTE: Stain repellent on upholstered seat only.

For available fabrics, refer to surfaces.haworth.com.

Improv Tag

Mesh Back with Height- and Width-Adjustable 3-D Arms



F235-2W42

Dimensions

SH: 16" - 21"
(406mm-533mm)
H: 37" - 42"
(940mm-1067mm)
D: 25" - 27 1/2"
(635mm-699mm)
W: 25"(635mm)
SW: 20"(508mm)
SD: 15 1/2" - 18"
(394mm-457mm)

Features

- Soft mesh back.
- Upholstered seat.
- Pneumatic height adjustment.
- Height- and width-adjustable 3-D arms with molded black vinyl arm caps.
- Sliding seat.
- Tilt tension.
- Standard with hard casters; optional soft casters available.
- Standard with five-star high arc plastic base; optional steel base available.
- Optional back-lock.
- Optional lumbar adjustment.
- Optional forward-tilt.
- Optional low position seat height/steel base.
- COM yardage / COL square footage:
Upholstered Seat: 0.75/20.0

To Order, Specify:

- 1) Product number.
- 2) Seat fabric.
- 3) Mesh back fabric.
TR-F Black trim (no need to specify).

Description	Number	Fabric Grade								Leather Grade A	Leather Grade B
		A	B	C	D	E	F	G	H		
Pneumatic Height	F235-2W42	\$1481.85	\$1559.98	\$1631.90	\$1682.74	\$1718.70	\$1739.79	\$1794.34	\$1946.87	\$2165.11	\$2352.24
Pneumatic Height/Back-Lock	F235-2W41	1538.89	1617.02	1688.94	1739.78	1775.74	1796.83	1851.38	2003.91	2222.15	2409.28
Pneumatic Height/Back-Lock/Lumbar	F235-2W43	1670.34	1748.47	1820.39	1871.23	1907.19	1928.28	1982.83	2135.36	2353.60	2540.73
Pneumatic Height/Lumbar	F235-2W44	1613.30	1691.43	1763.35	1814.19	1850.15	1871.24	1925.79	2078.32	2296.56	2483.69
Pneumatic Height/Forward-Tilt	F245-2W42	1537.66	1615.79	1687.71	1738.55	1774.51	1795.60	1850.15	2002.68	2220.92	2408.05
Pneumatic Height/Forward-Tilt/Lumbar	F245-2W44	1669.11	1747.24	1819.16	1870.00	1905.96	1927.05	1981.60	2134.13	2352.37	2539.50

The following options require modification of the product number.

Low position seat height/plastic base	To specify, change the 4th digit from a 5 to a 4; Example: F234-2W42
Steel base - Low height	To specify, change the 4th digit from a 5 to a 7; Example: F237-2W42
Soft casters	To specify, change the 7th digit from a 4 to a 2; Example: F235-2W22
Faux Leather seat	To specify, change the 2nd digit from a 2 to a 3; Example: F345-2W42
Leather seat	To specify, change the 2nd digit from a 2 to a 1; Example: F135-2W42
Stain repellent	To specify, add -P to the end of the product number; Example: F235-2W42-P (add \$39.68 list)

NOTE: Stain repellent on upholstered seat only.

For available fabrics, refer to surfaces.haworth.com.

Improv Series

Leg-Base Stacking Chairs

With Arms

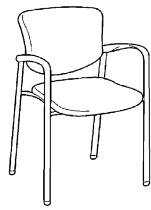

M600-2110

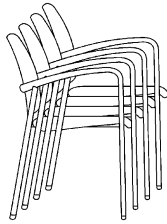

Dimensions

- H: 32"(813mm)
- W: 22"(559mm)
- D: 21 1/2"(546mm)
- SH: 18"(457mm)
- SD: 18"(457mm)
- SW: 19"(483mm)
- AH: 25 3/4"(654mm)

Features

- Optional: Full wood back.
- Optional: Legs with casters.
- Polypropylene or upholstered outer back shell.
- With glides, stacks 6-high (44"(1118mm)) on floor or 10-high (62"(1575mm)) on stacking dolly.
- With casters, stacks 5-high (42"(1067mm)) on floor or 6-high (50"(1270mm)) on dolly.
- Arms and molded floor glides match frame color except when ordering Metallic trim; molded components are available in black or smoke and must be specified.
- Non-ganging or ganging options. NOTE: An arm chair adjacent to a tablet arm cannot be ganged together.
- Optional book rack, see page 243.
- Fire retardant construction is available to comply with California Bulletin #133, see below.
- COM yardage/COL square footage:
Polypropylene back shell/upholstered seat: 0.75/15
Upholstered shell/seat: 1.25/28
Upholstered seat (wood back): 0.5

To Order, Specify:

- 1) Product number.
- 2) Fabric surface and color.
- 3) Frame/arms trim color.
- 4) Arm and glide trim color for metallic frame black or smoke option only.

To Order Chair with Wood Back, Specify:

- 1) Product number.
- 2) Fabric surface and color (seat).
- 3) Frame trim color.
- 4) Arm and glide trim color for metallic frame black or smoke option only.
- 5) Wood back finish color.



M600-2310

* All measurements taken with the BIFMA chair measuring device.

Outer/Inner Back Shell	Ganging	Number	Fabric Grade								Leather Grade A	Leather Grade B
			A	B	C	D	E	F	G	H		
Polypropylene/Upholstered	Non-ganging	M600-2110	\$491.10	\$525.56	\$539.58	\$571.46	\$600.82	\$649.26	\$683.68	\$778.08	\$ 829.10	\$ 996.56
	Ganging	M600-2110-5	\$49.77	\$84.23	\$98.25	\$30.13	\$59.49	\$70.93	\$74.35	\$86.75	\$87.77	\$105.23
Upholstered/Upholstered	Non-ganging	M600-2210	\$559.97	\$605.91	\$636.51	\$681.16	\$728.35	\$776.81	\$816.33	\$936.25	\$1021.70	\$1283.54
	Ganging	M600-2210-5	\$18.64	\$64.58	\$95.18	\$39.83	\$87.02	\$35.48	\$75.00	\$94.92	\$108.37	\$134.21
Wood Back	Non-ganging	M600-2310	\$613.55	\$648.01	\$662.03	\$693.91	\$723.27	\$771.71	\$806.13	\$900.53	\$ 951.55	\$1119.01
	Ganging	M600-2310-5	\$72.22	\$706.68	\$720.70	\$752.58	\$781.94	\$830.38	\$864.80	\$959.20	\$1010.22	\$1177.68

The following options require modification of the product number.

- Metallic trim color
- Hard casters
- Soft casters
- CAL 133
- Stain repellent
- Moisture barrier with stain repellent

- To specify, add **-M** after the 8th digit; **Example:** M600-2110-**M**
- To specify, change the 8th digit from a 0 to a 2; **Example:** M600-2112 (add \$65.04 list)
- To specify, change the 8th digit from a 0 to a 4; **Example:** M600-2114 (add \$65.04 list)
- To specify, add **-F** to the end of the product number; **Example:** M600-2210-**F** (add \$65.04 list)
- To specify, add **-P** to the end of the product number; **Example:** M600-2110-**P** (add \$40.82 list)
- To specify, add **-D** to the end of the product number; **Example:** M600-2110-**D** (add \$53.57 list)

NOTE: CAL 133 is available on fully upholstered outer back and wood back chair models only.

Caster option chairs also available on RUSH.

Casters should not be used on thick pile carpet applications.

For available fabrics, refer to surfaces.haworth.com.

Improv Series

Leg-Base Stacking Chairs

Without Arms

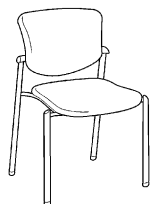

M600-2100

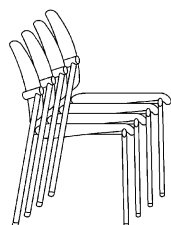

Dimensions

H: 32"(813mm)
 W: 22"(559mm)
 D: 21 1/2"(546mm)
 SH: 18"(457mm)
 SD: 18"(457mm)
 SW: 19"(483mm)

Features

- Optional: Full wood back.
- Polypropylene or upholstered outer back shell.
- Stacks 6-high (44"(1118mm)) on floor or 10-high (58"(1473mm)) on stacking dolly.
- High-density polyethylene leg caps and molded floor glides match frame color except when ordering Metallic trim; molded components are available in black or smoke and must be specified.
- Non-gangling or gangling options.
- Optional book rack, see page 243.
- Fire retardant construction is available to comply with California Bulletin #133, see below.
- COM yardage/COL square footage:
 Polypropylene back shell/upholstered seat: 0.75/15
 Upholstered shell/seat: 1.25/28
 Upholstered seat (wood back): 0.5

To Order, Specify:

- 1) Product number.
- 2) Fabric surface and color.
- 3) Frame trim color.
- 4) Leg caps and glides color for metallic frame black or smoke option only.

To Order Chair with Wood Back, Specify:

- 1) Product number.
- 2) Fabric surface and color (seat).
- 3) Frame trim color.
- 4) Leg caps and glides color for metallic frame black or smoke option only.
- 5) Wood back finish color.



M600-2300

Outer/Inner Back Shell	Gangling	Number	Fabric Grade								Leather Grade A	Leather Grade B
			A	B	C	D	E	F	G	H		
Polypropylene/Upholstered	Non-gangling	M600-2100	\$461.77	\$496.23	\$510.25	\$542.13	\$571.49	\$619.93	\$654.35	\$748.75	\$ 799.77	\$ 967.23
	Gangling	M600-2100-5	520.44	554.90	568.92	600.80	630.16	678.60	713.02	807.42	858.44	1025.90
Upholstered/Upholstered	Non-gangling	M600-2200	\$530.64	\$576.58	\$607.18	\$651.83	\$699.02	\$747.48	\$787.00	\$906.92	\$ 992.37	\$1254.21
	Gangling	M600-2200-5	589.31	635.25	665.85	710.50	757.69	806.15	845.67	965.59	1051.04	1312.88
Wood Back	Non-gangling	M600-2300	\$584.22	\$618.68	\$632.70	\$664.58	\$693.94	\$742.38	\$776.80	\$871.20	\$ 922.22	\$1089.68
	Gangling	M600-2300-5	642.89	677.35	691.37	723.25	752.61	801.05	835.47	929.87	980.89	1148.35

The following options require modification of the product number.

Metallic trim color

CAL 133

Stain repellent

Moisture barrier with stain repellent

To specify, add **-M** after the 8th digit; **Example:** M600-2100-**M**

To specify, add **-F** to the end of the product number; **Example:** M600-2200-**F** (add \$65.04 list)

To specify, add **-P** to the end of the product number; **Example:** M600-2100-**P** (add \$40.82 list)

To specify, add **-D** to the end of the product number; **Example:** M600-2100-**D** (add \$53.57 list)

NOTE: CAL 133 is available on fully upholstered outer back and wood back chair models only.

For available fabrics, refer to surfaces.haworth.com.

Improv Series

Leg-Base Stacking Chair with Tablet Arm

With Tablet Arm

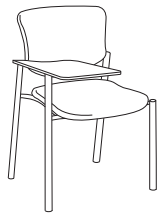

M600-2190
(Right-hand shown)

Dimensions

H: 32"(813mm)
 W: 23 1/4"(591mm)
 D: 26 3/4"(679mm)
 SH: 18"(457mm)
 SD: 18"(457mm)
 SW: 19"(483mm)
 AH: 27"(686mm)

Features

- Polypropylene or upholstered outer back shell.
- Leg caps, tablet arm and molded floor glides match frame color except when ordering Metallic trim; molded components are available in black or smoke and must be specified.
- Non-ganging or ganging options. NOTE: A tablet arm adjacent to another tablet arm or arm chair cannot be ganged together.
- Tablet is plywood core with high-pressure laminate surface and clear lacquered edge.
- Tablet flips up for easier access to seat.
- Optional book rack, see page 243.
- Fire retardant construction is available to comply with California Bulletin #133, see below.
- COM yardage/COL square footage:
 Polypropylene back shell: 0.75/15
 Upholstered back shell: 1.25/28

To Order, Specify:

- 1) Product number.
- 2) Fabric surface and color.
- 3) Frame trim color.
- 4) Leg caps, tablet arm and glides color for metallic frame black or smoke option only.
- 5) Tablet laminate surface color.

Outer Back Shell	Ganging	11"(279mm) Tablet	Number	Fabric Grade								Leather Grade A	Leather Grade B
				A	B	C	D	E	F	G	H		
Polypropylene	Non-ganging	Right-hand	M600-2190	\$674.77	\$709.23	\$723.25	\$755.13	\$784.49	\$ 832.93	\$ 867.35	\$ 961.75	\$1012.77	\$1180.23
		Left-hand	M600-2180	674.77	709.23	723.25	755.13	784.49	832.93	867.35	961.75	1012.77	1180.23
	Ganging	Right-hand	M600-2190-5	733.44	767.90	781.92	813.80	843.16	891.60	926.02	1020.42	1071.44	1238.90
		Left-hand	M600-2180-5	733.44	767.90	781.92	813.80	843.16	891.60	926.02	1020.42	1071.44	1238.90
Upholstered	Non-ganging	Right-hand	M600-2290	\$743.64	\$789.58	\$820.18	\$864.83	\$912.02	\$ 960.48	\$1000.00	\$1119.92	\$1205.37	\$1467.21
		Left-hand	M600-2280	743.64	789.58	820.18	864.83	912.02	960.48	1000.00	1119.92	1205.37	1467.21
	Ganging	Right-hand	M600-2290-5	802.31	848.25	878.85	923.50	970.69	1019.15	1058.67	1178.59	1264.04	1525.88
		Left-hand	M600-2280-5	802.31	848.25	878.85	923.50	970.69	1019.15	1058.67	1178.59	1264.04	1525.88

Outer Back Shell	Ganging	14"(356mm) Tablet	Number	Fabric Grade								Leather Grade A	Leather Grade B
				A	B	C	D	E	F	G	H		
Polypropylene	Non-ganging	Right-hand	M600-2170	\$706.65	\$741.11	\$755.13	\$787.01	\$ 816.37	\$ 864.81	\$ 899.23	\$ 993.63	\$1044.65	\$1212.11
		Left-hand	M600-2160	706.65	741.11	755.13	787.01	816.37	864.81	899.23	993.63	1044.65	1212.11
	Ganging	Right-hand	M600-2170-5	765.32	799.78	813.80	845.68	875.04	923.48	957.90	1052.30	1103.32	1270.78
		Left-hand	M600-2160-5	765.32	799.78	813.80	845.68	875.04	923.48	957.90	1052.30	1103.32	1270.78
Upholstered	Non-ganging	Right-hand	M600-2270	\$775.52	\$821.46	\$852.06	\$896.71	\$ 943.90	\$ 992.36	\$1031.88	\$1151.80	\$1237.25	\$1499.09
		Left-hand	M600-2260	775.52	821.46	852.06	896.71	943.90	992.36	1031.88	1151.80	1237.25	1499.09
	Ganging	Right-hand	M600-2270-5	834.19	880.13	910.73	955.38	1002.57	1051.03	1090.55	1210.47	1295.92	1557.76
		Left-hand	M600-2260-5	834.19	880.13	910.73	955.38	1002.57	1051.03	1090.55	1210.47	1295.92	1557.76

The following options require modification of the product number.

Metallic trim color
 CAL 133

To specify, add **-M** after the 8th digit; **Example:** M600-2190-M

To specify, add **-F** to the end of the product number; **Example:** M600-2290-F (add \$65.04 list)

NOTE: CAL 133 is available on fully upholstered outer back and wood back chair models only.

Improv Series

Sled-Base Chairs

With Arms, Non-Stacking

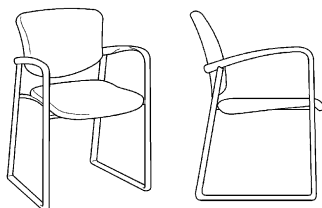

M601-2110

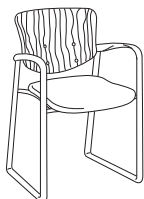

M601-2310

Dimensions

- H: 32"(813mm)
- W: 22"(559mm)
- D: 21 1/2"(546mm)
- SH: 18"(457mm)
- SD: 18"(457mm)
- SW: 19"(483mm)
- AH: 25 3/4"(654mm)

Features

- Optional: Full wood back.
- Polypropylene or upholstered outer back shell.
- Non-stacking.
- Arms and nylon sled-base runners match frame color except when ordering Metallic trim; molded components are available black or smoke and must be specified.
- Non-gangling or gangling options. NOTE: An arm chair adjacent to a tablet arm cannot be ganged together.
- Optional book rack, see page 243.
- Fire retardant construction is available to comply with California Bulletin #133, see below.
- COM yardage/COL square footage:
Polypropylene back shell/upholstered seat: 0.75/15
Upholstered shell/seat: 1.25/28
Upholstered seat (wood back): 0.5

To Order, Specify:

- 1) Product number.
- 2) Fabric surface and color.
- 3) Frame trim color.
- 4) Arm and sled base runners for metallic frame black or smoke option only.

To Order Chair with Wood Back, Specify:

- 1) Product number.
- 2) Fabric surface and color (seat).
- 3) Frame trim color.
- 4) Arm and sled base runners for metallic frame black or smoke option only.
- 5) Wood back finish color.

Outer/Inner Back Shell	Gangling	Number	Fabric Grade								Leather Grade A	Leather Grade B
			A	B	C	D	E	F	G	H		
Polypropylene/Upholstered	Non-gangling	M601-2110	\$639.05	\$673.51	\$687.53	\$719.41	\$748.77	\$797.21	\$ 831.63	\$ 926.03	\$ 977.05	\$1144.51
	Gangling	M601-2110-5	697.72	732.18	746.20	778.08	807.44	855.88	890.30	984.70	1035.72	1203.18
Upholstered/Upholstered	Non-gangling	M601-2210	\$707.92	\$753.86	\$784.46	\$829.11	\$876.30	\$924.76	\$ 964.28	\$1084.20	\$1169.65	\$1431.49
	Gangling	M601-2210-5	766.59	812.53	843.13	887.78	934.97	983.43	1022.95	1142.87	1228.32	1490.16
Wood Back	Non-gangling	M601-2310	\$761.50	\$795.96	\$809.98	\$841.86	\$871.22	\$919.66	\$ 954.08	\$1048.48	\$1099.50	\$1266.96
	Gangling	M601-2310-5	820.17	854.63	868.65	900.53	929.89	978.33	1012.75	1107.15	1158.17	1325.63

The following options require modification of the product number.

- Metallic trim color
- CAL 133
- Stain repellent
- Moisture barrier with stain repellent

- To specify, add **-M** after the 8th digit; **Example:** M601-2110-**M**
- To specify, add **-F** to the end of the product number; **Example:** M601-2210-**F** (add **\$65.04** list)
- To specify, add **-P** to the end of the product number; **Example:** M601-2110-**P** (add **\$40.82** list)
- To specify, add **-D** to the end of the product number; **Example:** M601-2110-**D** (add **\$53.57** list)

NOTE: CAL 133 is available on fully upholstered outer back and wood back chair models only.

For available fabrics, refer to surfaces.haworth.com.

Improv Series

Sled-Base Chairs

Without Arms, Non-Stacking

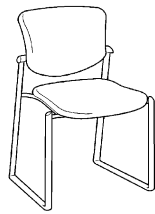

M601-2100

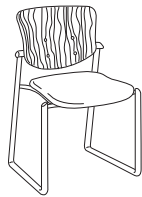
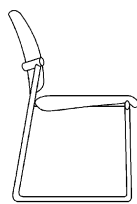

M601-2300

Dimensions

- H: 32"(813mm)
- W: 22"(559mm)
- D: 21 1/2"(546mm)
- SH: 18"(457mm)
- SD: 18"(457mm)
- SW: 19"(483mm)

Features

- Optional: Full wood back.
- Polypropylene or upholstered outer back shell.
- Non-stacking.
- High-density polyethylene leg caps and nylon sled-base runners match frame color except when ordering Metallic trim; molded components are available in black or smoke and must be specified.
- Wood back chairs have four color-matched bolts: black, graphite, smoke and Metallic trim chairs are standard with black bolts, and grey tone and stone chairs are standard with bronze bolts.
- Non-ganging or ganging options.
- Optional book rack, see page 243.
- Fire retardant construction is available to comply with California Bulletin #133, see below.
- COM yardage/COL square footage:
Polypropylene back shell/upholstered seat: 0.75/15
Upholstered back shell/seat: 1.25/28
Upholstered seat (wood back): 0.5

To Order, Specify:

- 1) Product number.
- 2) Fabric surface and color.
- 3) Frame trim color.
- 4) Leg caps and sled base runners color for metallic frame black or smoke option only.

To Order Chair with Wood Back, Specify:

- 1) Product number.
- 2) Fabric surface and color (seat).
- 3) Frame trim color.
- 4) Leg caps and sled base runners color for metallic frame black or smoke option only.
- 5) Wood back finish color.

Outer/Inner Back Shell	Ganging	Number	Fabric Grade								Leather Grade A	Leather Grade B
			A	B	C	D	E	F	G	H		
Polypropylene/Upholstered	Non-ganging	M601-2100	\$609.72	\$644.18	\$658.20	\$690.08	\$719.44	\$767.88	\$802.30	\$ 896.70	\$ 947.72	\$1115.18
	Ganging	M601-2100-5	668.39	702.85	716.87	748.75	778.11	826.55	860.97	955.37	1006.39	1173.85
Upholstered/Upholstered	Non-ganging	M601-2200	\$678.59	\$724.53	\$755.13	\$799.78	\$846.97	\$895.43	\$934.95	\$1054.87	\$1140.32	\$1402.16
	Ganging	M601-2200-5	737.26	783.20	813.80	858.45	905.64	954.10	993.62	1113.54	1198.99	1460.83
Wood Back	Non-ganging	M601-2300	\$732.17	\$766.63	\$780.65	\$812.53	\$841.89	\$890.33	\$924.75	\$1019.15	\$1070.17	\$1237.63
	Ganging	M601-2300-5	790.84	825.30	839.32	871.20	900.56	949.00	983.42	1077.82	1128.84	1296.30

The following options require modification of the product number.

- Metallic trim color
- CAL 133
- Stain repellent
- Moisture barrier with stain repellent

- To specify, add **-M** after the 8th digit; **Example:** M601-2100-**M**
- To specify, add **-F** to the end of the product number; **Example:** M601-2200-**F** (add **\$65.04** list)
- To specify, add **-P** to the end of the product number; **Example:** M601-2100-**P** (add **\$40.84** list)
- To specify, add **-D** to the end of the product number; **Example:** M601-2100-**D** (add **\$53.57** list)

NOTE: CAL 133 is available on fully upholstered outer back and wood back chair models only.

For available fabrics, refer to surfaces.haworth.com.

Improv Series

Sled-Base Chair with Tablet Arm

Non-Stacking

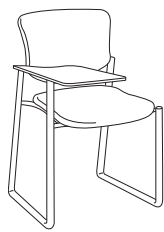

M601-2190
(Right-hand shown)



Dimensions

- H: 32"(813mm)
- W: 23 1/4"(591mm)
- D: 26 3/4"(679mm)
- H: 18"(457mm)
- SD: 18"(457mm)
- SW: 19"(483mm)
- AH: 27"(686mm)

Features

- Polypropylene or upholstered outer back shell.
- Non-stacking.
- High-density polyethylene leg caps, tablet arm and nylon sled-base runners match frame color except when ordering Metallic trim; molded components are available in black or smoke and must be specified.
- Non-ganging or ganging options. NOTE: A tablet arm adjacent to another tablet arm or arm chair cannot be ganged together.
- Tablet is plywood core with high-pressure laminate surface and clear lacquered edge.
- Tablet flips up for easier access to seat.
- Optional book rack, see page 243.
- Fire retardant construction is available to comply with California Bulletin #133, see below.
- COM yardage/COL square footage:
Polypropylene back shell: 0.75/15
Upholstered back shell: 1.25/28

To Order, Specify:

- 1) Product number.
- 2) Fabric surface and color.
- 3) Frame trim color.
- 4) Leg caps, tablet arm and steel base runners color for metallic frame black or smoke option only.
- 5) Tablet laminate surface color.

Outer Back Shell	Ganging	11"(279mm) Tablet		Fabric Grade								Leather Grade A	Leather Grade B
		Right-hand	Left-hand	A	B	C	D	E	F	G	H		
Polypropylene	Non-ganging	Right-hand	M601-2190	\$822.72	\$857.18	\$ 871.20	\$ 903.08	\$ 932.44	\$ 980.88	\$1015.30	\$1109.70	\$1160.72	\$1328.18
		Left-hand	M601-2180	822.72	857.18	871.20	903.08	932.44	980.88	1015.30	1109.70	1160.72	1328.18
	Ganging	Right-hand	M601-2190-5	881.39	915.85	929.87	961.75	991.11	1039.55	1073.97	1168.37	1219.39	1386.85
		Left-hand	M601-2180-5	881.39	915.85	929.87	961.75	991.11	1039.55	1073.97	1168.37	1219.39	1386.85
Upholstered	Non-ganging	Right-hand	M601-2290	\$891.59	\$937.53	\$ 968.13	\$1012.78	\$1059.97	\$1108.43	\$1147.95	\$1267.87	\$1353.32	\$1615.16
		Left-hand	M601-2280	891.59	937.53	968.13	1012.78	1059.97	1108.43	1147.95	1267.87	1353.32	1615.16
	Ganging	Right-hand	M601-2290-5	950.26	996.20	1026.80	1071.45	1118.64	1167.10	1206.62	1326.54	1411.99	1673.83
		Left-hand	M601-2280-5	950.26	996.20	1026.80	1071.45	1118.64	1167.10	1206.62	1326.54	1411.99	1673.83

Outer Back Shell	Ganging	14"(356mm) Tablet		Fabric Grade								Leather Grade A	Leather Grade B
		Right-hand	Left-hand	A	B	C	D	E	F	G	H		
Polypropylene	Non-ganging	Right-hand	M601-2170	\$854.60	\$ 889.06	\$ 903.08	\$ 934.96	\$ 964.32	\$1012.76	\$1047.18	\$1141.58	\$1192.60	\$1360.06
		Left-hand	M601-2160	854.60	889.06	903.08	934.96	964.32	1012.76	1047.18	1141.58	1192.60	1360.06
	Ganging	Right-hand	M601-2170-5	913.27	947.73	961.75	993.63	1022.99	1071.43	1105.85	1200.25	1251.27	1418.73
		Left-hand	M601-2160-5	913.27	947.73	961.75	993.63	1022.99	1071.43	1105.85	1200.25	1251.27	1418.73
Upholstered	Non-ganging	Right-hand	M601-2270	\$923.47	\$ 969.41	\$1000.01	\$1044.66	\$1091.85	\$1140.31	\$1179.83	\$1299.75	\$1385.20	\$1647.04
		Left-hand	M601-2260	923.47	969.41	1000.01	1044.66	1091.85	1140.31	1179.83	1299.75	1385.20	1647.04
	Ganging	Right-hand	M601-2270-5	982.14	1028.08	1058.68	1103.33	1150.52	1198.98	1238.50	1358.42	1443.87	1705.71
		Left-hand	M601-2260-5	982.14	1028.08	1058.68	1103.33	1150.52	1198.98	1238.50	1358.42	1443.87	1705.71

The following options require modification of the product number.

- Metallic trim color
- CAL 133
- Stain repellent
- Moisture barrier with stain repellent

- To specify, add **-M** after the 8th digit; **Example:** M601-2190-**M**
- To specify, add **-F** to the end of the product number; **Example:** M601-2290-**F** (add \$65.04 list)
- To specify, add **-P** to the end of the product number; **Example:** M601-2190-**P** (add \$40.82 list)
- To specify, add **-D** to the end of the product number; **Example:** M601-2190-**D** (add \$53.57 list)

NOTE: CAL 133 is available on fully upholstered outer back and wood back chair models only.

For available fabrics, refer to surfaces.haworth.com.

Improv Series

Stools

With Arms

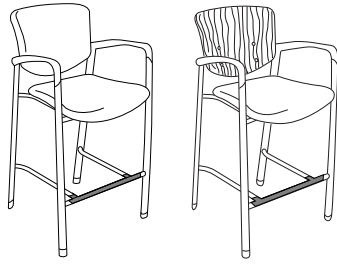

M600-8110

M600-8310

Dimensions

SH: 27 1/2"(699mm)
 H: 41 1/4"(1048mm)
 D: 23"(584mm)
 W: 22"(559mm)
 SW: 19"(483mm)
 SD: 18"(457mm)
 BW: 18 1/4"(464mm)
 AH: 35 1/2"(902mm)
 FH: 10 1/2"(267mm)

Features

- Optional: Full wood back.
- Polypropylene or upholstered outer back shell.
- Arms and molded floor glides match frame color except when ordering Metallic trim; molded components are available in black or smoke and must be specified.
- Wood back chairs have four color-matched bolts: black, graphite, smoke and Metallic trim chairs are standard with black bolts, and grey tone, stone and tan chairs are standard with blackened bronze bolts.
- Distance between the arms is 19 1/4"(489mm).
- Foot rest nylon cover is available in charcoal finish color only.
- Fire retardant construction is available to comply with California Bulletin #133, see below.
- COM yardage/COL square footage:
 Polypropylene shell: 0.75/15
 Upholstered shell: 1.25/28
 Upholstered seat (wood back): 0.5

To Order, Specify:

- 1) Product number.
- 2) Fabric surface and color.
- 3) Frame trim color.
- 4) Arms and glides color for metallic frame black or smoke option only.

To Order Stool with Wood Back, Specify:

- 1) Product number.
- 2) Fabric surface and color (seat).
- 3) Frame trim color.
- 4) Arms and glides color for metallic frame black or smoke option only.
- 5) Wood back finish color.

Outer/Inner Back Shell	Number	Fabric Grade		C	D	E	F	G	H	Leather Grade A	Leather Grade B
		A	B								
Polypropylene/Upholstered	M600-8110	\$862.26	\$ 896.72	\$ 910.74	\$ 942.62	\$ 971.98	\$1020.42	\$1054.84	\$1149.24	\$1200.26	\$1367.72
Upholstered/Upholstered	M600-8210	931.13	977.07	1007.67	1052.32	1099.51	1147.97	1187.49	1307.41	1392.86	1654.70
Wood Back	M600-8310	984.71	1019.17	1033.19	1065.07	1094.43	1142.87	1177.29	1271.69	1322.71	1490.17

The following options require modification of the product number.

Metallic trim color
 CAL 133

To specify, add **-M** after the 8th digit; **Example:** M600-8110-**M**
 To specify, add **-F** to the end of the product number; **Example:** M600-8210-**F** (add \$65.04 list)

NOTE: CAL 133 is available on fully upholstered outer back and wood back chair models only.

Without Arms

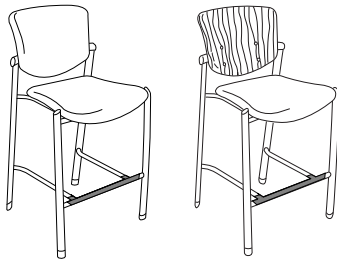

M600-8100

M600-8300

Dimensions

SH: 27 1/2"(699mm)
 H: 41 1/4"(1048mm)
 D: 23"(584mm)
 W: 22"(559mm)
 SW: 19"(483mm)
 SD: 18"(457mm)
 BW: 18 1/4"(464mm)
 FH: 10 1/2"(267mm)

Features

- Optional: Full wood back.
- Polypropylene or upholstered outer back shell.
- High-density polyethylene leg caps and molded floor glides match frame color except when ordering Metallic trim; molded components are available in black or smoke and must be specified.
- Wood back chairs have four color-matched bolts: black, graphite, smoke and Metallic trim chairs are standard with black bolts, and grey tone, stone and tan chairs are standard with blackened bronze bolts.
- Foot rest nylon cover is available in charcoal finish color only.
- Fire retardant construction is available to comply with California Bulletin #133, see below.
- COM yardage/COL square footage:
 Polypropylene shell: 0.75/15
 Upholstered shell: 1.25/28
 Upholstered seat (wood back): 0.5

To Order, Specify:

- 1) Product number.
- 2) Fabric surface and color.
- 3) Frame trim color.
- 4) Leg caps and glides color for metallic frame black or smoke option only.

To Order Stool with Wood Back, Specify:

- 1) Product number.
- 2) Fabric surface and color (seat).
- 3) Frame trim color.
- 4) Leg caps and glides color for metallic frame black or smoke option only.
- 5) Wood back finish color.

Polypropylene/Upholstered	M600-8100	\$832.93	\$867.39	\$ 881.41	\$ 913.29	\$ 942.65	\$ 991.09	\$1025.51	\$1119.91	\$1170.93	\$1338.39
Upholstered/Upholstered	M600-8200	901.80	947.74	978.34	1022.99	1070.18	1118.64	1158.16	1278.08	1363.53	1625.37
Wood Back	M600-8300	955.38	989.84	1003.86	1035.74	1065.10	1113.54	1147.96	1242.36	1293.38	1460.84

The following options require modification of the product number.

Metallic trim color
 CAL 133
 Stain repellent
 Moisture barrier with stain repellent

To specify, add **-M** after the 8th digit; **Example:** M600-8100-**M**
 To specify, add **-F** to the end of the product number; **Example:** M600-8200-**F** (add \$65.04 list)
 To specify, add **-P** to the end of the product number; **Example:** M600-8100-**P** (add \$40.82 list)
 To specify, add **-D** to the end of the product number; **Example:** M600-8100-**D** (add \$53.57 list)

NOTE: CAL 133 is available on fully upholstered outer back and wood back chair models only.

For available fabrics, refer to surfaces.haworth.com.

Improv Series

Accessories

	Height	Width	Depth	Number	Price
Stacking Dolly	15"(381mm)	24 1/4"(616mm)	28"(711mm)	MPRV-CART	\$385.58

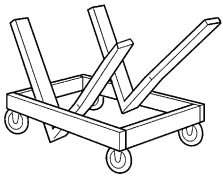

MPRV-CART

Features

- 3"(76mm) hard rubber casters.
- Recommended stacking limit is 10 chairs high (58"(1473mm) armless, 62"(1575mm) with arms, 6-high on casters (50"(1270mm)).
- Entire depth with chairs stacked is 39 3/4"(1009mm).
- Standard in black finish color only.
- Ships assembled.

To Order, Specify:

- 1) Product number.
(No finish specification required.)

Book Rack	6 3/4"(159mm)	15 1/4"(387mm)	14 1/2"(368mm)	MPRV-RACK	\$68.51
------------------	---------------	----------------	----------------	-----------	----------------

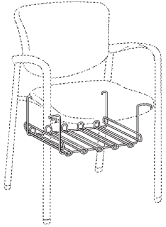

MPRV-RACK

Features

- Field attachable to an Improv leg-base or sled-base side chair.
- Standard in chrome finish only.

To Order, Specify:

- 1) Product number.
(No finish specification required.)

Improv Series

Tandem Seating and Tables

Specification and Ordering Information

Specify standard Improv Series chair models, tandem tables, and chair-to-chair connecting bars to create a continuous seating configuration.

Use the following guidelines when specifying and ordering Improv seating and tables for tandem configurations:

- 1) Specify the desired chair models from pages 236-240.
 - All chair models are designed to accept both table and chair-to-chair connecting bars.
 - NOTE: It is not necessary to order ganging chair models to create a tandem configuration.
- 2) Specify chair-to-chair connecting bars from page 246.
 - One set of connecting bars will join two chairs in tandem.
 - Exceptions:
 - Tablet arm cannot be connected adjacent to an arm chair.
 - Tablet arm cannot be connected adjacent to another tablet arm.
- 3) Specify tandem table models from page 246.
 - Select in-line or end-of-run tables based on desired configuration. Tandem table models include all table-to-chair connecting hardware.
 - Tandem tables cannot be connected to each other.

Specification Example

The following example illustrates a tandem seating and table configuration.

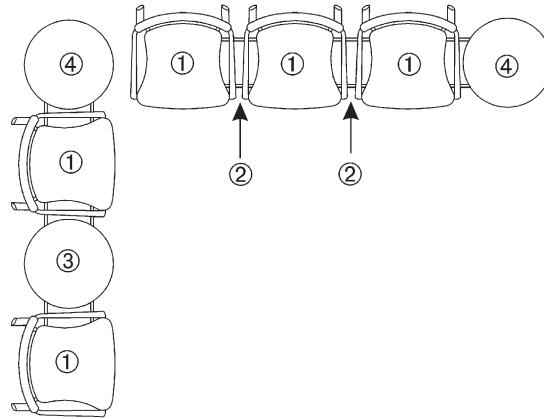

Item	Qty	Number	Description
1	5	M600-2210	Leg-Base Arm Chairs
2	2	MPRV-BARS	Chair-to-Chair Connecting Bars
3	1	MTI1-20	In-Line Tandem Table
4	2	MTE1-20	End-of-Run Tandem Tables

Improv Series

Tandem Seating and Tables

Calculating Tandem Seating Dimensions

Use the following dimensions to determine the footprint of an Improv Series tandem seating configuration.

- 1) All arm and armless chair models are 22" (559mm) wide and 21 1/2" (546mm) deep. Tablet arm chair models are 26 3/4" (679mm) deep. When a tablet arm chair ends a seating configuration, add 1 3/4" (44mm) to the total configuration width.

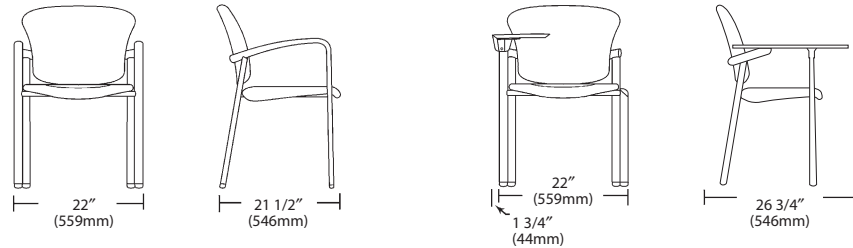

- 2) Add 1 1/4" (32mm) to the width of the seating run for every chair-to-chair connecting bar.

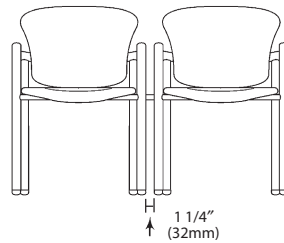

- 3) For every in-line table, add 18 3/4" (476mm) to the width of the seating run.

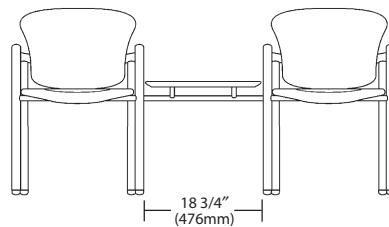

- 4) For every end-of-run table, add 19 3/8" (492mm) to the width of the seating run.

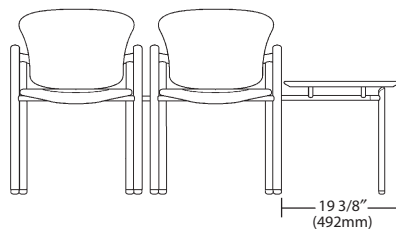

Improv Series

Tandem Tables and Connecting Bars

	Height	Width	Depth	Table Top/Edge	Number	Price
In-Line Table	20"(508mm)	18 3/4"(476mm)	20"(508mm)	Laminate/Bullnose PVC	MTI1-20	\$443.94
				Laminate/Chamfered Hardwood	MTI2-20	591.51
				Wood/Chamfered Hardwood	MTI3-20	655.99

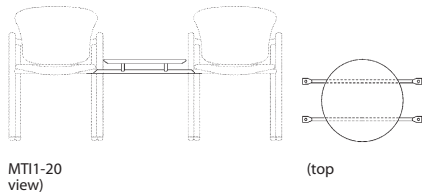

Features

- Table suspends between two Improv chairs in a tandem configuration.
- Table top diameter is 20"(508mm).
- Width shown is distance between front legs of adjoining chairs.
- Price includes installation hardware.

To Order, Specify:

- 1) Product number.
- 2) Laminate or wood surface color.
- 3) PVC or hardwood edge finish color. (Laminate table tops only.)
- 4) Support frame trim color.

To order table with Metallic trim color add **-M** after sixth digit.

Example: MTI1-20-M

End-of-Run Table	20"(508mm)	19 3/8"(492mm)	20"(508mm)	Laminate/Bullnose PVC	MTE1-20	\$534.46
				Laminate/Chamfered Hardwood	MTE2-20	682.03
				Wood/Chamfered Hardwood	MTE3-20	744.04

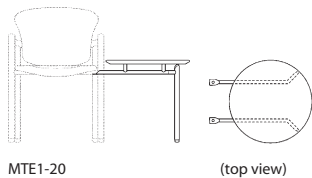

Features

- Table attaches to the end of an Improv chair in a tandem configuration.
- Table top diameter is 20"(508mm).
- Width shown is distance between front leg of adjoining chair to outermost edge of table.
- Molded floor guides match frame color except when ordering Metallic trim; molded components are available in black or smoke and must be specified.
- Price includes installation hardware.

To Order, Specify:

- 1) Product number.
- 2) Laminate or wood surface color.
- 3) PVC or hardwood edge finish color. (Laminate table tops only.)
- 4) Support frame trim color.
- 5) Glides color for metallic frame black or smoke only.

To order table with Metallic trim color add **-M** after sixth digit.

Example: MTE1-20-M

Chair-to-Chair Connecting Bars	1 1/4"(32mm)	MPRV-BARS	\$57.59
---------------------------------------	--------------	-----------	----------------

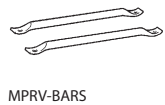

Features

- Connects two Improv Series chairs side-by-side with the following exceptions:
 - A tablet arm adjacent to an arm chair.
 - A tablet arm adjacent to another tablet arm.
- Width shown is distance between front legs of adjoining chairs.
- Each chair-to-chair connection requires two connecting bars.
- Price includes two (2) bars.

To Order, Specify:

- 1) Product number.
- 2) Trim color.

To order connecting bars with Metallic trim color add **-M** after eighth digit.

Example: MPRV-BARS-M

Improv Series

Occasional Tables

Height	Table Top/Edge	Number	Laminate		Wood Surface
			A	B	
16"(406mm)	Laminate/Bullnose PVC	MTR1-20-1	\$534.46	\$603.90	N/A
	Laminate/Chamfered Hardwood	MTR2-20-1	722.94	792.38	N/A
Wood only	Wood/Chamfered Hardwood	MTR3-20-1	N/A	N/A	744.01
20"(508mm)	Laminate/Bullnose PVC	MTR1-20-2	\$534.46	\$603.90	N/A
	Laminate/Chamfered Hardwood	MTR2-20-2	722.94	792.38	N/A
Wood only	Wood/Chamfered Hardwood	MTR3-20-2	N/A	N/A	744.01

Round Table

MTR1-20



(top view)

Features

- Table top diameter is 20"(508mm).
- Oval steel tube legs with color-matched high-density polyethylene floor glides and leg polypropylene caps except when ordering Metallic trim; molded components are available in black or smoke and must be specified.
- Shipped fully assembled.

NOTE: Due to the differences in the material properties, the MDF edge will display a darker stain in comparison with the veneer surface.

To Order, Specify:

- 1) Product number.
- 2) Laminate or wood surface color.
- 3) PVC or hardwood edge finish color. (Laminate table tops only.)
- 4) Frame trim color.
- 5) Glides and leg caps for metallic frame; black or smoke option only.

To order table with Metallic trim color add **M** after seventh digit.

Example: MTR1-20-1**M**

Table Top Edge Details

Bullnose PVC



Chamfered Hardwood

This page intentionally blank

LOOK Seating

General Specifications

COM & COL**General Information**

To order a COM fabric (Customer's Own Material), contact the Haworth Inquiry Center (1.800.426.8562), your local Haworth dealer, or go to haworth.com/surfaces > COM Library to find out if the COM you have selected has already been tested and approved. The surface collection site also has information on the Haworth+ alliance program with Carnegie, Luna Textiles, and Maharam as well as our industry-leading Pre-Approved COM program.

COM fabrics are placed into Grades based on the cost per linear yard. If a fabric's cost exceeds the range of our highest Grade it will be noted as Non-Graded. The product will be priced at Grade A; the COM fabric costs will appear as a separate line item. The fabric charge will be Haworth's purchase cost plus a 4% administrative fee (based on the cost of the fabric). Yardage calculations will include any applicable fabric repeat.

COM Leather products will be priced at a leather Grade A; COL costs will appear as a separate line item. The leather costs will be Haworth's purchase cost plus a 4% administrative fee (based on the cost of the leather).

General Guidelines for Product Specification

LOOK seating specification numbers are based on an alpha-numeric logic that identifies a product by model and certain characteristics.

For example, a product number that reads **Z841-1741** identifies the product as a Mid-Back LOOK chair with forward tilt, fabric upholstery, pneumatic height adjustment, upholstered shell, height adjustable arms, pivoting arm pads, hard dual casters, and back lock.

The alpha-numeric logic for this model complete with fabric and finish codes is shown below:

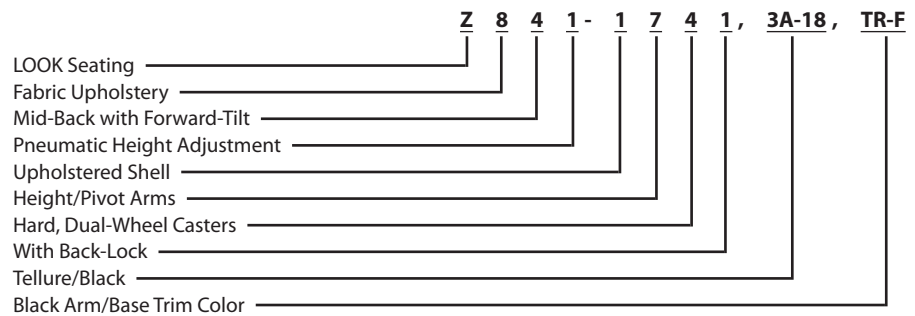

Replace second digit in product number with 7 for leather. Example: **Z741-1741**.

Beyond the printed product number, fabric and finish codes are required to complete an order specification. To communicate your order clearly, list the product number and fabric/finish codes in the sequence outlined on each price page.

Finishes and Fabrics

A complete listing of finishes and fabrics for LOOK seating can be found in the back of the price list.

Features and Options (High- and Mid-Back Chairs)

LOOK chairs features:

- Molded-polyfoam, contoured seat and back cushions
- Separate seat and back cushions
- Five-star base with black casters only
- Hard dual-wheel casters (standard) or soft dual-wheel casters (optional)
- Pneumatic seat height adjustment
- Width adjustable arms, height adjustable arms, fixed arms, armless
- Tilt tension

LOOK Seating

General Specifications

Mobility and Adjustability (High- and Mid-Back Chairs)

The following features are available on LOOK chair models.

- Synchronized-tilt (standard)
- Back and seat recline at a 2:1 ratio with no front seat rise
- Back tilts backward 20° from the upright position
- Seat pan moves downward 10° from the initial position
- Synchronized-tilt with back-lock
- Back is lockable in four positions within tilt range
- Forward-tilt
- Both chair back and seat pan are lockable in one forward position (3°)
- Seat pan slides horizontally within a 2”(51mm) range
- Back adjusts vertically within a 3”(76mm) range
- Height adjustable arm adjust vertically within a 4”(102mm) range
- Adjustable arms rotate 360°
- Width adjustable arms adjust vertically within a 4”(102mm) range and rotate 360°, and go in/out 2”(51mm).

Features and Options (Side Chairs)

LOOK Series side chair models feature:

- 14-gauge round steel tubing legs
- Double shell seat and back construction
- Molded polyurethane seat and back foam
- Fully upholstered back shell, or full plastic back
- High-density polyethylene floor glides (leg-base models)
- All models available with caster option
- Powder coated frame: available in black and three metallic colors
- Side chair without arms models stack 6-high (44”(1118mm)) on the floor
- Side chair with arms models stack 4-high on the floor
- Side chair with casters stacks 4-high on the floor
- Lounge chair stacks 2-high on the floor

Arm chair models feature:

- Round tubing
- Optional plastic arm cap

Lounge models feature:

- Inner arm shell with foam and upholstery

LOOK series chairs meet or exceed ANSI/BIFMA durability standards for office seating.

LOOK Seating

High-Back Chair without Arms



Z851-1042

Dimensions*

- SH: 16" - 20.75"
(406mm - 527mm)
- H: 43.5" - 51.25"
(1105mm - 1302mm)
- D: 26.5"(673mm)
- W: 26.25"(667mm)
- SW: 18.5"(470mm)
- SD: 15" - 17"
(381mm - 432mm)

Features

- Outer Shell: Upholstered
- Casters: Standard with hard casters; or optional soft casters, see below.
- Mechanism: Swivel with synchronized-tilt.
- Height Adjustment: Pneumatic
- 2"(51mm) Seat depth adjustment.
- 3"(76mm) Back height adjustment.
- Optional Back-Lock: Lockable in four positions.
- Optional forward tilt is 3°.
- Tilt tension.
- User Instructions: Embossed on stainless steel inserts on levers. Instructions in braille on underside of levers.
- COM yardage / COL square footage: 2.0/30

To Order, Specify:

- 1) Product number.
- 2) Fabric surface and color.
- 3) Trim color for arms and base (TR-F Black only).

* All measurements taken with the BIFMA chair measuring device.

Outer Shell	Number	Fabric Grade		C	D	E	F	G	H	Leather Grade A	Leather Grade B
		A	B								
Pneumatic Height Adjustment											
Upholstered	Z851-1042	\$882.27	\$ 963.17	\$1041.53	\$1074.39	\$1122.45	\$1308.25	\$1397.97	\$1649.52	\$1463.71	\$1645.45
Pneumatic Height Adjustment/Back-Lock/Forward Tilt											
Upholstered	Z861-1041	\$994.77	\$1075.67	\$1154.03	\$1186.89	\$1234.95	\$1420.75	\$1510.47	\$1762.02	\$1576.21	\$1757.95

The following options require modification of the product number.

- Soft Casters
- Stain Repellent
- Leather Upholstery

To specify, change the 7th digit from a **4** (hard caster) to a **2** (soft caster); **Example:** Z851-1022
 To specify, add **-P** to the end of the product number; **Example:** Z851-1042-**P** (add \$40.45 list)
 To specify, change the 2nd digit in the product number from an **8** to a **7** and specify the leather surface and color; **Example:** Z851-1042 (chair with fabric); Z751-1042 (chair with leather)

NOTE: For available fabrics, refer to surfaces.haworth.com.

LOOK Seating

High-Back Chair with Fixed Arms



Z851-1442

Dimensions*

- SH: 16" - 20.75"
(406mm - 527mm)
- H: 43.5" - 51.25"
(1105mm - 1302mm)
- D: 26.5"(673mm)
- W: 26.25"(667mm)
- SW: 18.5"(470mm)
- SD: 15" - 17"
(381mm - 432mm)
- AH: 9"(229mm)
- AW: 18.75"(476mm)

Features

- Outer Shell: Upholstered
- Arm Caps: Soft black vinyl.
- Casters: Standard with hard casters; or optional soft casters, see below.
- Mechanism: Swivel with synchronized-tilt.
- Height Adjustment: Pneumatic
- 2"(51mm) Seat depth adjustment.
- 3"(76mm) Back height adjustment.
- Optional Back-Lock: Lockable in four positions.
- Optional forward tilt is 3°.
- Tilt tension.
- User Instructions: Embossed on stainless steel inserts on levers. Instructions in braille on underside of levers.
- COM yardage / COL square footage: 2.0/30

To Order, Specify:

- 1) Product number.
- 2) Fabric surface and color.
- 3) Trim color for arms and base (TR-F Black only).

* All measurements taken with the BIFMA chair measuring device.

Outer Shell	Arm Cap	Number	Fabric Grade								Leather Grade A	Leather Grade B
			A	B	C	D	E	F	G	H		
Pneumatic Height Adjustment												
Upholstered	Soft Black Vinyl	Z851-1442	\$ 983.39	\$1064.29	\$1142.65	\$1175.51	\$1223.57	\$1409.37	\$1499.09	\$1750.64	\$1564.83	\$1746.57
Pneumatic Height Adjustment/Back-Lock/Forward Tilt												
Upholstered	Soft Black Vinyl	Z861-1441	\$1095.89	\$1176.79	\$1255.15	\$1288.01	\$1336.07	\$1521.87	\$1611.59	\$1863.14	\$1677.33	\$1859.07

The following options require modification of the product number.

- Soft Casters To specify, change the 7th digit from a 4 (hard caster) to a 2 (soft caster); **Example:** Z851-1422
- Stain Repellent To specify, add -P to the end of the product number; **Example:** Z851-1442-P (add \$40.45 list)
- Leather Upholstery To specify, change the 2nd digit in the product number from an 8 to a 7 and specify the leather surface and color; **Example:** Z851-1442 (chair with fabric); Z751-1442 (chair with leather)

NOTE: For available fabrics, refer to surfaces.haworth.com.

LOOK Seating

High-Back Chair with Height Adjustable Arms



Z851-1742

Dimensions*

SH: 16" - 20.75"
(406mm - 527mm)
H: 43.5" - 51.25"
(1105mm - 1302mm)
D: 26.5"(673mm)
W: 26.25"(667mm)
SW: 18.5"(470mm)
SD: 15" - 17"
(381mm - 432mm)
AH: 8" - 12"
(203mm - 305mm)
AW: 18.75"(476mm)

Features

- Outer Shell: Upholstered
- Arm Caps: Soft black vinyl.
- Arm Height Adjustment: 4"(102mm) adjustment.
- Arm Adjustment Controls: Fingertip activation.
- Arm Pad Rotation: 360°
- Casters: Standard with hard casters; or optional soft casters, see below.
- Mechanism: Swivel with synchronized-tilt.
- Height Adjustment: Pneumatic
- 2"(51mm) Seat depth adjustment.
- 3"(76mm) Back height adjustment.
- Optional Back-Lock: Lockable in four positions.
- Optional forward tilt is 3°.
- Tilt tension.
- User Instructions: Embossed on stainless steel inserts on levers. Instructions in braille on underside of levers.
- COM yardage / COL square footage: 2.0/30

To Order, Specify:

- 1) Product number.
- 2) Fabric surface and color.
- 3) Trim color for arms and base (TR-F Black only).

* All measurements taken with the BIFMA chair measuring device.

Outer Shell	Arm Cap	Number	Fabric Grade		C	D	E	F	G	H	Leather Grade A	Leather Grade B
			A	B								
Pneumatic Height Adjustment												
Upholstered	Soft Black Vinyl	Z851-1742	\$1103.47	\$1184.37	\$1262.73	\$1295.59	\$1343.65	\$1529.45	\$1619.17	\$1870.72	\$1684.91	\$1866.65
Pneumatic Height Adjustment/Back-Lock/Forward Tilt												
Upholstered	Soft Black Vinyl	Z861-1741	\$1215.97	\$1296.87	\$1375.23	\$1408.09	\$1456.15	\$1641.95	\$1731.67	\$1983.22	\$1797.41	\$1979.15

The following options require modification of the product number.

Soft Casters
Stain Repellent
Leather Upholstery

To specify, change the 7th digit from a **4** (hard caster) to a **2** (soft caster); **Example:** Z851-1722

To specify, add **-P** to the end of the product number; **Example:** Z851-1742-**P** (add **\$40.45** list)

To specify, change the 2nd digit in the product number from an **8** to a **7** and specify the leather surface and color; **Example:** Z851-1742 (chair with fabric); Z751-1742 (chair with leather)

NOTE: For available fabrics, refer to surfaces.haworth.com.

LOOK Seating

High-Back Chair with Height and Width Adjustable Arms



Z851-1W42

Dimensions*

- SH: 16" - 20.75"
(406mm - 527mm)
- H: 43.5" - 51.25"
(1105mm - 1302mm)
- D: 26.5"(673mm)
- W: 26.25"(667mm)
- SW: 18.5"(470mm)
- SD: 15" - 17"
(381mm - 432mm)
- AH: 8" - 12"
(203mm - 305mm)
- AW: 18.5" - 20.5"
(470mm - 521mm)

Features

- Outer Shell: Upholstered
- Arm Caps: Soft black vinyl.
- Arm Height Adjustment: 4"(102mm) adjustment.
- Arm Width Adjustment: 2"(51mm) adjustment.
- Arm Adjustment Controls: Fingertip activation.
- Arm Pad Rotation: 360°
- Casters: Standard with hard casters; or optional soft casters, see below.
- Mechanism: Swivel with synchronized-tilt.
- Height Adjustment: Pneumatic
- 2"(51mm) Seat depth adjustment.
- 3"(76mm) Back height adjustment.
- Optional Back-Lock: Lockable in four positions.
- Optional forward tilt is 3°.
- Tilt tension.
- User Instructions: Embossed on stainless steel inserts on levers. Instructions in braille on underside of levers.
- COM yardage / COL square footage: 2.0/30

To Order, Specify:

- 1) Product number.
- 2) Fabric surface and color.
- 3) Trim color for arms and base (TR-F Black only).

* All measurements taken with the BIFMA chair measuring device.

Outer Shell	Arm Cap	Number	Fabric Grade								Leather Grade A	Leather Grade B
			A	B	C	D	E	F	G	H		
Pneumatic Height Adjustment												
Upholstered	Soft Black Vinyl	Z851-1W42	\$1140.13	\$1221.03	\$1299.39	\$1332.25	\$1380.31	\$1566.11	\$1655.83	\$1907.38	\$1721.57	\$1903.31
Pneumatic Height Adjustment/Back-Lock/Forward Tilt												
Upholstered	Soft Black Vinyl	Z861-1W41	\$1252.63	\$1333.53	\$1411.89	\$1444.75	\$1492.81	\$1678.61	\$1768.33	\$2019.88	\$1834.07	\$2015.81

The following options require modification of the product number.

- Soft Casters To specify, change the 7th digit from a **4** (hard caster) to a **2** (soft caster); **Example:** Z851-1W22
- Stain Repellent To specify, add **-P** to the end of the product number; **Example:** Z851-1W42-P (add **\$40.45** list)
- Leather Upholstery To specify, change the 2nd digit in the product number from an **8** to a **7** and specify the leather surface and color; **Example:** Z851-1W42 (chair with fabric); Z751-1W42 (chair with leather)

NOTE: For available fabrics, refer to surfaces.haworth.com.

LOOK Seating

Mid-Back Chair without Arms



Z831-1042

Dimensions*

- SH: 16" - 20.75"
(406mm - 527mm)
- H: 40" - 47.75"
(1016mm - 1213mm)
- D: 26.5"(673mm)
- W: 26.25"(667mm)
- SW: 18.5"(470mm)
- SD: 15" - 17"
(381mm - 432mm)

Features

- Outer Shell: Upholstered
- Casters: Standard with hard casters; or optional soft casters, see below.
- Mechanism: Swivel with synchronized-tilt.
- Height Adjustment: Pneumatic
- 2"(51mm) Seat depth adjustment.
- 3"(76mm) Back height adjustment.
- Optional Back-Lock: Lockable in four positions.
- Optional forward tilt is 3°.
- Tilt tension.
- User Instructions: Embossed on stainless steel inserts on levers. Instructions in braille on underside of levers.
- COM yardage / COL square footage: 1.5/30

To Order, Specify:

- 1) Product number.
- 2) Fabric surface and color.
- 3) Trim color for arms and base (TR-F Black only).

*All measurements taken with the BIFMA chair measuring device.

Outer Shell	Number	Fabric Grade		C	D	E	F	G	H	Leather Grade A	Leather Grade B
		A	B								
Pneumatic Height Adjustment											
Upholstered	Z831-1042	\$802.64	\$883.54	\$ 961.90	\$ 994.76	\$1042.82	\$1118.64	\$1184.36	\$1371.44	\$1384.08	\$1565.82
Pneumatic Height Adjustment/Back-Lock/Forward Tilt											
Upholstered	Z841-1041	\$915.14	\$996.04	\$1074.40	\$1107.26	\$1155.32	\$1231.14	\$1296.86	\$1483.94	\$1496.58	\$1678.32

The following options require modification of the product number.

- Soft Casters
- Stain Repellent
- Leather Upholstery

To specify, change the 7th digit from a **4** (hard caster) to a **2** (soft caster); **Example:** Z831-1022
 To specify, add **-P** to the end of the product number; **Example:** Z831-1042-**P** (add **\$40.45** list)
 To specify, change the 2nd digit in the product number from an **8** to a **7** and specify the leather surface and color;
Example: Z831-1042 (chair with fabric); Z731-1042 (chair with leather)

NOTE: For available fabrics, refer to surfaces.haworth.com.

LOOK Seating

Mid-Back Chair with Fixed Arms



Z831-1442

Dimensions*

- SH: 16" - 20.75"
(406mm - 527mm)
- H: 40" - 47.75"
(1016mm - 1213mm)
- D: 26.5"(673mm)
- W: 26.25"(667mm)
- SW: 18.5"(470mm)
- SD: 15" - 17"
(381mm - 432mm)
- AH: 9"(229mm)
- AW: 18.75"(476mm)

Features

- Outer Shell: Upholstered
- Arm Caps: Soft black vinyl.
- Casters: Standard with hard casters; or optional soft casters, see below.
- Mechanism: Swivel with synchronized-tilt.
- Height Adjustment: Pneumatic
- 2"(51mm) Seat depth adjustment.
- 3"(76mm) Back height adjustment.
- Optional Back-Lock: Lockable in four positions.
- Optional forward tilt is 3°.
- Tilt tension.
- User Instructions: Embossed on stainless steel inserts on levers. Instructions in braille on underside of levers.
- COM yardage / COL square footage: 1.5/30

To Order, Specify:

- 1) Product number.
- 2) Fabric surface and color.
- 3) Trim color for arms and base (TR-F Black only).

*All measurements taken with the BIFMA chair measuring device.

Outer Shell	Arm Cap	Number	Fabric Grade		C	D	E	F	G	H	Leather Grade A	Leather Grade B
			A	B								
Pneumatic Height Adjustment												
Upholstered	Soft Black Vinyl	Z831-1442	\$ 903.76	\$ 984.66	\$1063.02	\$1095.88	\$1143.94	\$1219.76	\$1285.48	\$1472.56	\$1485.20	\$1666.94
Pneumatic Height Adjustment/Back-Lock/Forward Tilt												
Upholstered	Soft Black Vinyl	Z841-1441	\$1016.26	\$1097.16	\$1175.52	\$1208.38	\$1256.44	\$1332.26	\$1397.98	\$1585.06	\$1597.70	\$1779.44

The following options require modification of the product number.

- Soft Casters To specify, change the 7th digit from a 4 (hard caster) to a 2 (soft caster); **Example:** Z831-1422
- Stain Repellent To specify, add -P to the end of the product number; **Example:** Z831-1442-P (add \$40.45 list)
- Leather Upholstery To specify, change the 2nd digit in the product number from an 8 to a 7 and specify the leather surface and color; **Example:** Z831-1442 (chair with fabric); Z751-1442 (chair with leather)

NOTE: For available fabrics, refer to surfaces.haworth.com.

LOOK Seating

Mid-Back Chair with Height Adjustable Arms



Z831-1742

Dimensions*

SH: 16" - 20.75"
(406mm - 527mm)
H: 40" - 47.75"
(1016mm - 1213mm)
D: 26.5"(673mm)
W: 26.25"(667mm)
SW: 18.5"(470mm)
SD: 15" - 17"
(381mm - 432mm)
AH: 8" - 12"
(203mm - 305mm)
AW: 18.75"(476mm)

Features

- Outer Shell: Upholstered
- Arm Caps: Soft black vinyl.
- Arm Height Adjustment: 4"(102mm) adjustment.
- Arm Adjustment Controls: Fingertip activation.
- Arm Pad Rotation: 360°
- Casters: Standard with hard casters; or optional soft casters, see below.
- Mechanism: Swivel with synchronized-tilt.
- Height Adjustment: Pneumatic
- 2"(51mm) Seat depth adjustment.
- 3"(76mm) Back height adjustment.
- Optional Back-Lock: Lockable in four positions.
- Optional forward tilt is 3°.
- Tilt tension.
- User Instructions: Embossed on stainless steel inserts on levers. Instructions in braille on underside of levers.
- COM yardage / COL square footage: 1.5/30

To Order, Specify:

- 1) Product number.
- 2) Fabric surface and color.
- 3) Trim color for arms and base (TR-F Black only).

*All measurements taken with the BIFMA chair measuring device.

Outer Shell	Arm Cap	Number	Fabric Grade		C	D	E	F	G	H	Leather Grade A	Leather Grade B
			A	B								
Pneumatic Height Adjustment												
Upholstered	Soft Black Vinyl	Z831-1742	\$1023.84	\$1104.74	\$1183.10	\$1215.96	\$1264.02	\$1339.84	\$1405.56	\$1592.64	\$1605.28	\$1787.02
Pneumatic Height Adjustment/Back-Lock/Forward Tilt												
Upholstered	Soft Black Vinyl	Z841-1741	\$1136.34	\$1217.24	\$1295.60	\$1328.46	\$1376.52	\$1452.34	\$1518.06	\$1705.14	\$1717.78	\$1899.52

The following options require modification of the product number.

Soft Casters
Stain Repellent
Leather Upholstery

To specify, change the 7th digit from a **4** (hard caster) to a **2** (soft caster); **Example:** Z831-1722
To specify, add **-P** to the end of the product number; **Example:** Z831-1742-**P** (add **\$40.45** list)
To specify, change the 2nd digit in the product number from an **8** to a **7** and specify the leather surface and color; **Example:** Z831-1742 (chair with fabric); Z731-1742 (chair with leather)

NOTE: For available fabrics, refer to surfaces.haworth.com.

LOOK Seating

Mid-Back Chair with Height and Width Adjustable Arms



Z831-1W42

Dimensions*

- SH: 16" - 20.75"
(406mm - 527mm)
- H: 40" - 47.75"
(1016mm - 1213mm)
- D: 26.5"(673mm)
- W: 26.25"(667mm)
- SW: 18.5"(470mm)
- SD: 15" - 17"
(381mm - 432mm)
- AH: 8" - 12"
(203mm - 305mm)
- AW: 18.5"-20.5"
(470mm- 521mm)

Features

- Outer Shell: Upholstered
- Arm Caps: Soft black vinyl.
- Arm Height Adjustment: 4"(102mm) adjustment.
- Arm Width Adjustment: 2"(51mm) adjustment.
- Arm Adjustment Controls: Fingertip activation.
- Arm Pad Rotation: 360°
- Casters: Standard with hard casters; or optional soft casters, see below.
- Mechanism: Swivel with synchronized-tilt.
- Height Adjustment: Pneumatic
- 2"(51mm) Seat depth adjustment.
- 3"(76mm) Back height adjustment.
- Optional Back-Lock: Lockable in four positions.
- Optional forward tilt is 3°.
- Tilt tension.
- User Instructions: Embossed on stainless steel inserts on levers. Instructions in braille on underside of levers.
- COM yardage / COL square footage: 1.5/30

To Order, Specify:

- 1) Product number.
- 2) Fabric surface and color.
- 3) Trim color for arms and base (TR-F Black only).

*All measurements taken with the BIFMA chair measuring device.

Outer Shell	Arm Cap	Number	Fabric Grade								Leather Grade A	Leather Grade B
			A	B	C	D	E	F	G	H		
Pneumatic Height Adjustment												
Upholstered	Soft Black Vinyl	Z831-1W42	\$1060.50	\$1141.40	\$1219.76	\$1252.62	\$1300.68	\$1376.50	\$1442.22	\$1629.30	\$1641.94	\$1823.68
Pneumatic Height Adjustment/Back-Lock/Forward Tilt												
Upholstered	Soft Black Vinyl	Z841-1W41	\$1173.00	\$1253.90	\$1332.26	\$1365.12	\$1413.18	\$1489.00	\$1554.72	\$1741.80	\$1754.44	\$1936.18

The following options require modification of the product number.

- Soft Casters To specify, change the 7th digit from a **4** (hard caster) to a **2** (soft caster); **Example:** Z831-1W22
- Stain Repellent To specify, add **-P** to the end of the product number; **Example:** Z831-1W42-P (add \$40.45 list)
- Leather Upholstery To specify, change the 2nd digit in the product number from an **8** to a **7** and specify the leather surface and color; **Example:** Z831-1W42 (chair with fabric); Z731-1W42 (chair with leather)

NOTE: For available fabrics, refer to surfaces.haworth.com.

LOOK Seating

Side Chairs

Without Arms

Z600-2100

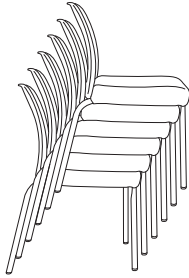
**Dimensions***

H: Upholstered:
33.75"(857mm)
Polypropylene:
32.25"(819mm)
W: 20.37"(517mm)
D: 24"(610mm)
SH: 18"(457mm)
SD: 18.25"(463mm)
SW: 18.75"(476mm)

Features

- Polypropylene or upholstered back shell.
- Optional: Legs with casters
- Stacks 6-high on floor.
- Back flex is 2"(51mm).
- Molded floor glides are standard in black
- COM Yardage/COL square footage:
Polypropylene Back Shell: 0.85/16
Upholstered Back Shell: 1.85/35

* All measurements taken with the BIFMA chair measuring device.

To Order, Specify:

- 1) Product number.
- 2) Back surface and color.
- 3) Frame trim color.

To Order Chair with Polypropylene Back, Specify:

- 1) Product number.
- 2) Fabric surface and color (seat).
- 3) Polypropylene back finish color.
- 4) Frame trim color.

Back	Number	Fabric Grade								Leather Grade A	Leather Grade B
		A	B	C	D	E	F	G	H		
Polypropylene	Z600-2100	\$367.52	\$414.14	\$458.04	\$477.22	\$506.03	\$562.24	\$602.03	\$ 717.21	\$ 700.76	\$ 877.90
Upholstered	Z600-2200	421.00	511.50	604.78	640.40	695.26	842.00	933.90	1179.35	1087.48	1441.76

The following options require modification of the product number.

Hard Casters

To specify, change the 8th digit from a **0** (floor glides) to a **4** (hard caster); **Example:** Z600-210**4** (add **\$65.10** list)

Soft Casters

To specify, change the 8th digit from a **0** (floor glides) to a **2** (soft caster); **Example:** Z600-210**2** (add **\$65.10** list)

Stain Repellent

To specify, add **-P** to the end of the product number; **Example:** Z600-2100-**P** (add **\$40.07** list)

Moisture Barrier with Stain Repellent

To specify, add **-D** to the end of the product number; **Example:** Z600-2100-**D** (add **\$52.58** list)

NOTE: For available fabrics, refer to surfaces.haworth.com.

LOOK Seating

Side Chairs

With Arms

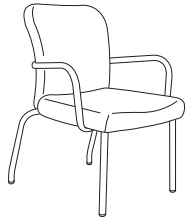

Z600-2210

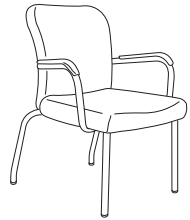

Z600-2230

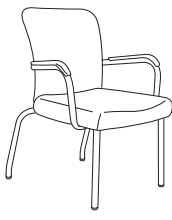

Z600-2130

Dimensions*

H: Upholstered:
33.75"(857mm)
Polypropylene:
32.25"(819mm)
W: 24"(610mm)
D: 24"(610mm)
SH: 18"(457mm)
SD: 18.25"(463mm)
SW: 18.75"(476mm)

Features

- Polypropylene or upholstered back shell.
- Optional: Legs with casters
- Chairs with arms and glides stack 6-high.
- Chairs with arms and casters stack 3-high.
- Back flex is 2"(51mm).
- Arms formed from steel tubular frame.
- Arm caps and molded floor glides are standard in black.
- COM Yardage/COL square footage:
Polypropylene Back Shell: 0.85/16
Upholstered Back Shell: 1.85/35

* All measurements taken with the BIFMA chair measuring device.

To Order, Specify:

- 1) Product number.
- 2) Back surface and color.
- 3) Frame/arm trim color.

To Order Chair with Polypropylene Back, Specify:

- 1) Product number.
- 2) Fabric surface and color (seat).
- 3) Polypropylene back finish color.
- 4) Frame/arm trim color.

Back	Arms	Number	Fabric Grade								Leather Grade A	Leather Grade B
			A	B	C	D	E	F	G	H		
Polypropylene	Standard	Z600-2110	\$412.78	\$459.40	\$503.30	\$522.48	\$551.29	\$607.50	\$ 647.29	\$ 762.47	\$ 746.02	\$ 923.16
	Arm Caps	Z600-2130	440.21	486.83	530.73	549.91	578.72	634.93	674.72	789.90	773.45	950.59
Upholstered	Standard	Z600-2210	\$466.26	\$556.76	\$650.04	\$685.66	\$740.52	\$887.26	\$ 979.16	\$1224.61	\$1132.74	\$1487.02
	Arm Caps	Z600-2230	493.69	584.19	677.47	713.09	767.95	914.69	1006.59	1252.04	1160.17	1514.45

The following options require modification of the product number.

- | | |
|---------------------------------------|---|
| Hard Casters | To specify, change the 8th digit from a 0 (floor glides) to a 4 (hard caster); Example: Z600-2114 (add \$65.10 list) |
| Soft Casters | To specify, change the 8th digit from a 0 (floor glides) to a 2 (soft caster); Example: Z600-2112 (add \$65.10 list) |
| Stain Repellent | To specify, add -P to the end of the product number; Example: Z600-2110-P (add \$40.07 list) |
| Moisture Barrier with Stain Repellent | To specify, add -D to the end of the product number; Example: Z600-2110-D add \$52.58 list) |

NOTE: For available fabrics, refer to surfaces.haworth.com.

LOOK Seating

Lounge Chairs

Lounge Chair

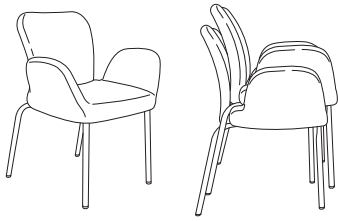

Z600-2440

Dimensions*

- H: 33.75"(857mm)
- W: 25"(635mm)
- D: 24"(610mm)
- SH: 18"(457mm)
- SD: 18.25"(463mm)
- SW: 18.15"(461mm)

Features

- Fully upholstered inner and outer back.
- Optional: Legs with casters
- Stacks 2-high on floor.
- Back flex is 2"(51mm).
- Fully upholstered panel arms.
- Molded floor glides are standard in black.
- COM yardage / COL square footage: 2.35/48

* All measurements taken with the BIFMA chair measuring device.

To Order, Specify:

- 1) Product number.
- 2) Back surface and color.
- 3) Frame trim color.

Back	Arms	Number	Fabric Grade								Leather Grade A	Leather Grade B
			A	B	C	D	E	F	G	H		
Upholstered	Panel	Z600-2440	\$822.80	\$913.30	\$1006.58	\$1042.20	\$1097.06	\$1356.24	\$1472.83	\$1788.23	\$1489.28	\$1843.56

The following options require modification of the product number.

- Hard Casters To specify, change the 8th digit from a **0** (floor glides) to a **4** (hard caster); **Example:** Z600-2444 (add **\$65.10** list)
- Soft Casters To specify, change the 8th digit from a **0** (floor glides) to a **2** (soft caster); **Example:** Z600-2442 (add **\$65.10** list)
- Stain Repellent To specify, add **-P** to the end of the product number; **Example:** Z600-2440-P (add **\$40.07** list)
- Moisture Barrier with Stain Repellent To specify, add **-D** to the end of the product number; **Example:** Z600-2440-D add **\$52.58** list)

NOTE: For available fabrics, refer to surfaces.haworth.com.

This page intentionally blank

Monaco

General Specifications

Design: 5D Studio

Features and Options

All Monaco models feature:

- Optional large or medium scales
- Fully-upholstered seat and back
- Five-star base
- Pneumatic height adjustment with 6-position back lock
- 3"(76mm) back height adjustment
- Optional adjustable lumbar support — 1 1/2"(38mm)

Mobility and Adjustability

Five-star base models feature:

- Cast aluminum base
- Molded-polyfoam contoured seat and back cushions
- Cast aluminum arms
- Hard, dual-wheel casters for carpeted floors
- Soft, dual-wheel casters for resilient floor surfaces
- Pneumatic height adjustment
- Synchronized tilt recline with tension control and 6-position back lock

Synchronized tilt

- Back reclines at a two-to-one ratio to the pitch of the seat
- Front-edge seat height maintained through tilt mode
- Lockable in six positions within the tilt range (back lock)

Value Packs

Monaco chairs are offered in 6, 8 and 10-Chair "Value Packs" for your convenience. Value packs allow you to order one part number for your entire conference room. Value packs are offered at a reduced list price.



6-Chair Value Pack for Monaco Large High-Back Chairs

Monaco

General Specifications

COM & COL General Information

To order a COM fabric (Customer's Own Material), contact the Haworth Inquiry Center (1.800.426.8562), your local Haworth dealer, or go to haworth.com/surfaces > COM Library to find out if the COM you have selected has already been tested and approved. The surface collection site also has information on the Haworth+ alliance program with Carnegie, Luna Textiles, and Maharam as well as our industry-leading Pre-Approved COM program.

COM fabrics are placed into Grades based on the cost per linear yard. If a fabric's cost exceeds the range of our highest Grade it will be noted as Non-Graded. The product will be priced at Grade A; the COM fabric costs will appear as a separate line item. The fabric charge will be Haworth's purchase cost plus a 4% administrative fee (based on the cost of the fabric). Yardage calculations will include any applicable fabric repeat.

COM Leather products will be priced at a leather Grade A; COL costs will appear as a separate line item. The leather costs will be Haworth's purchase cost plus a 4% administrative fee (based on the cost of the leather).

Flammability Requirements

Monaco chair models are available with an optional fire retardant construction to comply with California Bulletin #133. Refer to the price pages for ordering information. Refer to Haworth.com/surfaces for a listing of the approved fabrics.

General Guidelines for Product Specification

Monaco specification numbers are based on a numeric logic that identifies a product by model and certain characteristics.

For instance, a product number that reads **D811-2240** identifies the product as a Large High-Back Monaco Chair, with fabric upholstery, pneumatic height adjustment, open arms, hard casters, and without lumbar adjustment.

The numeric logic for this model with fabric and finish codes is shown below:

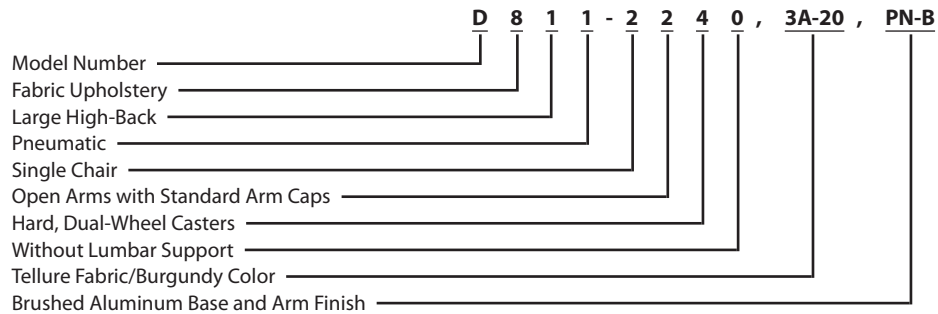

A ninth-digit suffix of the product number will indicate functional options, such as **-F** for CAL 133 option. There are exceptions to this logic; therefore, always refer to the price charts for product numbers rather than attempting to construct them. Product number modification instructions for additional options appear in footnoted copy for each applicable model.

Beyond the printed product number, fabric and finish codes are required to complete an order specification. To communicate your order clearly, list the product number and finish codes in the sequence outlined on each price page.

Finishes and Fabrics

A complete listing of finishes and fabrics for Monaco seating is available in the back of the price list.

Monaco

Large High-Back Chair with Open Arms



D811-2240

Dimensions

SH: 16" - 20 1/2"
(406mm-521mm)
H: 48 1/2" - 56"
(1232mm-1422mm)
D: 26"(660mm)
W: 30"(762mm)
SW: 23 1/2"(597mm)
SD: 21 1/2"(546mm)
AH: 26 1/3" - 31 1/3"
(577mm-689mm)

Features

- Pneumatic height adjustment.
- Flexible headrest.
- Fully-upholstered shell.
- Standard with 6-position back lock.
- Five-star, cast aluminum base with dual-wheel casters.
- Casters and column standard in black finish color.
- Arms available with standard black soft or upholstered caps.
- Standard with 3"(76mm) of back height adjustment.
- COM yardage: 4.0
- COL square footage: 72.0

To Order, Specify:

- 1) Product number.
- 2) Fabric surface and color.
- 3) Base and arm trim color. Add **\$87.20** for Brushed Aluminum (PN-B) finish.

NOTE:

CAD symbol for Value Packs shows one chair but represents quantity of chairs within Value Pack.

Arms/ Caps	Quantity	Number	Fabric Grade		C	D	E	F	G	H	Leather Grade A	Leather Grade B
			A	B								
Without Lumbar Support - Standard												
	1 chair	D811-2240	\$ 3207.87	\$ 3322.08	\$ 3392.09	\$ 3576.31	\$ 3658.59	\$ 4006.15	\$ 4176.85	\$ 4650.92	\$ 4550.21	\$ 5117.26
	6-chair Value Pack	D811-A240	18098.92	18784.18	19204.24	20309.56	20803.24	22888.60	23912.80	26757.22	26152.96	29555.26
	8-chair Value Pack	D811-B240	24125.35	25039.03	25599.11	27072.87	27731.11	30511.59	31877.19	35669.75	34864.07	39400.47
	10-chair Value Pack	D811-C240	30494.43	31636.53	32336.63	34178.83	35001.63	38477.23	40184.23	44924.93	43917.83	49588.33
Without Lumbar Support - Upholstered												
	1 chair	D811-2340	\$ 3286.46	\$ 3400.67	\$ 3470.68	\$ 3654.90	\$ 3737.18	\$ 4084.74	\$ 4255.44	\$ 4729.51	\$ 4628.80	\$ 5195.85
	6-chair Value Pack	D811-A340	18570.46	19255.72	19675.78	20781.10	21274.78	23360.14	24384.34	27228.76	26624.50	30026.80
	8-chair Value Pack	D811-B340	24754.07	25667.75	26227.83	27701.59	28359.83	31140.31	32505.91	36298.47	35492.79	40029.19
	10-chair Value Pack	D811-C340	31280.33	32422.43	33122.53	34964.73	35787.53	39263.13	40970.13	45710.83	44703.73	50374.23
With Lumbar Support - Standard												
	1 chair	D811-2241	\$ 3395.78	\$ 3509.99	\$ 3580.00	\$ 3764.22	\$ 3846.50	\$ 4194.06	\$ 4364.76	\$ 4838.83	\$ 4738.12	\$ 5305.17
	6-chair Value Pack	D811-A241	19226.38	19911.64	20331.70	21437.02	21930.70	24016.06	25040.26	27884.68	26152.96	29555.26
	8-chair Value Pack	D811-B241	25628.63	26542.31	27102.39	28576.15	29234.39	32014.87	33380.47	37173.03	36367.35	40903.75
	10-chair Value Pack	D811-C241	32373.53	33515.63	34215.73	36057.93	36880.73	40356.33	42063.33	46804.03	45796.93	51467.43
With Lumbar Support - Upholstered												
	1 chair	D811-2341	\$ 3474.37	\$ 3588.58	\$ 3658.59	\$ 3842.81	\$ 3925.09	\$ 4272.65	\$ 4443.35	\$ 4917.42	\$ 4816.71	\$ 5383.76
	6-chair Value Pack	D811-A341	19697.92	20383.18	20803.24	21908.56	22402.24	24487.60	25511.80	28356.22	27751.96	31154.26
	8-chair Value Pack	D811-B341	26257.35	27171.03	27731.11	29204.87	29863.11	32643.59	34009.19	37801.75	36996.07	41532.47
	10-chair Value Pack	D811-C341	33159.43	34301.53	35001.63	36843.83	37666.63	41142.23	42849.23	47589.93	46582.83	52253.33

The following options require modification of the product number.

- Soft Casters
- CAL 133
- Stain Repellent
- Leather Upholstery

To specify, change the 7th digit from a 4 (hard caster) to a 2 (soft caster); **Example:** D811-2220

To specify, add -F to end of the product number (add \$625.11 list); **Example:** D811-2240-F

To specify, add -P to the end of the product number; **Example:** D811-2240-P (add \$63.85 list)

To specify, change the 2nd digit in the product number from an 8 to a 7 and specify the leather surface and color; **Example:** D811-2240 (chair with fabric); D711-2240 (chair with leather)

NOTE: CAL 133 is available on all chairs models in leather.

Stain repellent is not available on leather.

For available fabrics, refer to surfaces.haworth.com.

Monaco

Large High-Back Chair with Enclosed Arms



D811-2640

NOTE:
CAD symbol for Value Packs shows one chair but represents quantity of chairs within Value Pack.

Dimensions

SH: 16" - 20 1/2"
(406mm-521mm)
H: 48 1/2" - 56"
(1232mm-1422mm)
D: 26"(660mm)
W: 30"(762mm)
SW: 23 1/2"(597mm)
SD: 21 1/2"(546mm)
AH: 26 1/3" - 31 1/3"
(577mm-689mm)

Features

- Pneumatic height adjustment.
- Flexible headrest.
- Fully-upholstered shell.
- Standard with 6-position back lock.
- Five-star, cast aluminum base with dual-wheel casters.
- Casters and column standard in black finish color.
- Arms enclosed.
- Standard with 3"(76mm) of back height adjustment.
- COM yardage: 4.0
- COL square footage: 72.0

To Order, Specify:

- 1) Product number.
- 2) Fabric surface and color.
- 3) Base trim color. Add **\$87.20** for Brushed Aluminum (PN-B) finish.

Arms/ Caps	Quantity	Number	Fabric Grade		C	D	E	F	G	H	Leather Grade A	Leather Grade B
			A	B								
Without Lumbar Support - Standard												
	1 chair	D811-2640	\$ 3207.87	\$ 3322.08	\$ 3392.09	\$ 3576.31	\$ 3658.59	\$ 4006.15	\$ 4176.85	\$ 4650.92	\$ 4550.21	\$ 5117.26
	6-chair Value Pack	D811-A640	18098.92	18784.18	19204.24	20309.56	20803.24	22888.60	23912.80	26757.22	26152.96	29555.26
	8-chair Value Pack	D811-B640	24125.35	25039.03	25599.11	27072.87	27731.11	30511.59	31877.19	35669.75	34864.07	39400.47
	10-chair Value Pack	D811-C640	30494.43	31636.53	32336.63	34178.83	35001.63	38477.23	40184.23	44924.93	43917.83	49588.33
With Lumbar Support - Standard												
	1 chair	D811-2641	\$ 3395.78	\$ 3509.99	\$ 3580.00	\$ 3764.22	\$ 3846.50	\$ 4194.06	\$ 4364.76	\$ 4838.83	\$ 4738.12	\$ 5305.17
	6-chair Value Pack	D811-A641	19226.38	19911.64	20331.70	21437.02	21930.70	24016.06	25040.26	27884.68	27280.42	30682.72
	8-chair Value Pack	D811-B641	25628.63	26542.31	27102.39	28576.15	29234.39	32014.87	33380.47	37173.03	36367.35	40903.75
	10-chair Value Pack	D811-C641	32373.53	33515.63	34215.73	36057.93	36880.73	40356.33	42063.33	46804.03	45796.93	51467.43

The following options require modification of the product number.

Soft Casters

CAL 133

Stain Repellent

Leather Upholstery

To specify, change the 7th digit from a **4** (hard caster) to a **2** (soft caster); **Example:** D811-2620

To specify, add **-F** to end of the product number (add **\$625.11** list); **Example:** D811-2640-**F**

To specify, add **-P** to the end of the product number; **Example:** D811-2640-**P** (add **\$63.85** list)

To specify, change the 2nd digit in the product number from an **8** to a **7** and specify the leather surface and color;
Example: D811-2640 (chair with fabric); D711-2640 (chair with leather)

NOTE: CAL 133 is available on all chairs models in leather.

Stain repellent is not available on leather.

For available fabrics, refer to surfaces.haworth.com.

Monaco

Medium High-Back Chair with Open Arms



D821-2240

Dimensions

SH: 16" - 20 1/2"
(406mm-521mm)
H: 45" - 52 1/2"
(1143mm-1334mm)
D: 23 1/2"(597mm)
W: 26"(660mm)
SW: 22"(559mm)
SD: 20"(508mm)
AH: 26 1/3" - 31 1/3"
(577mm-689mm)

Features

- Pneumatic height adjustment.
- Flexible headrest.
- Fully-upholstered shell.
- Standard with 6-position back lock.
- Five-star, cast aluminum base with dual-wheel casters.
- Casters and column standard in black finish color.
- Arms available with standard black soft or upholstered caps.
- Standard with 3"(76mm) of back height adjustment.
- COM yardage: 3.75
- COL square footage: 67.5

To Order, Specify:

- 1) Product number.
- 2) Fabric surface and color.
- 3) Base and arm trim color. Add **\$87.20** for Brushed Aluminum (PN-B) finish.

NOTE:

CAD symbol for Value Packs shows one chair but represents quantity of chairs within Value Pack.

Arms/ Caps	Quantity	Number	Fabric Grade								Leather Grade A	Leather Grade B
			A	B	C	D	E	F	G	H		
Without Lumbar Support - Standard												
	1 chair	D821-2240	\$ 3207.87	\$ 3322.08	\$ 3392.09	\$ 3576.31	\$ 3658.59	\$ 4006.15	\$ 4176.85	\$ 4650.92	\$ 4550.21	\$ 5117.26
	6-chair Value Pack	D821-A240	18098.92	18784.18	19204.24	20309.56	20803.24	22888.60	23912.80	26757.22	26152.96	29555.26
	8-chair Value Pack	D821-B240	24125.35	25039.03	25599.11	27072.87	27731.11	30511.59	31877.19	35669.75	34864.07	39400.47
	10-chair Value Pack	D821-C240	30494.43	31636.53	32336.63	34178.83	35001.63	38477.23	40184.23	44924.93	43917.83	49588.33
Without Lumbar Support - Upholstered												
	1 chair	D821-2340	\$ 3286.46	\$ 3400.67	\$ 3470.68	\$ 3654.90	\$ 3737.18	\$ 4084.74	\$ 4255.44	\$ 4729.51	\$ 4628.80	\$ 5195.85
	6-chair Value Pack	D821-A340	18570.46	19255.72	19675.78	20781.10	21274.78	23360.14	24384.34	27228.76	26624.50	30026.80
	8-chair Value Pack	D821-B340	24754.07	25667.75	26227.83	27701.59	28359.83	31140.31	32505.91	36298.47	35492.79	40029.19
	10-chair Value Pack	D821-C340	31280.33	32422.43	33122.53	34964.73	35787.53	39263.13	40970.13	45710.83	44703.73	50374.23
With Lumbar Support - Standard												
	1 chair	D821-2241	\$ 3395.78	\$ 3509.99	\$ 3580.00	\$ 3764.22	\$ 3846.50	\$ 4194.06	\$ 4364.76	\$ 4838.83	\$ 4738.12	\$ 5305.17
	6-chair Value Pack	D821-A241	19226.38	19911.64	20331.70	21437.02	21930.70	24016.06	25040.26	27884.68	27280.42	30682.72
	8-chair Value Pack	D821-B241	25628.63	26542.31	27102.39	28576.15	29234.39	32014.87	33380.47	37173.03	36367.35	40903.75
	10-chair Value Pack	D821-C241	32373.53	33515.63	34215.73	36057.93	36880.73	40356.33	42063.33	46804.03	45796.93	51467.43
With Lumbar Support - Upholstered												
	1 chair	D821-2341	\$ 3474.37	\$ 3588.58	\$ 3658.59	\$ 3842.81	\$ 3925.09	\$ 4272.65	\$ 4443.35	\$ 4917.42	\$ 4816.71	\$ 5383.76
	6-chair Value Pack	D821-A341	19697.92	20383.18	20803.24	21908.56	22402.24	24487.60	25511.80	28356.22	27751.96	31154.26
	8-chair Value Pack	D821-B341	26257.35	27171.03	27731.11	29204.87	29863.11	32643.59	34009.19	37801.75	36996.07	41532.47
	10-chair Value Pack	D821-C341	33159.43	34301.53	35001.63	36843.83	37666.63	41142.23	42849.23	47589.93	46582.83	52253.33

The following options require modification of the product number.

- Soft Casters
- CAL 133
- Stain Repellent
- Leather Upholstery

To specify, change the 7th digit from a 4 (hard caster) to a 2 (soft caster); **Example:** D821-2220

To specify, add -F to end of the product number (add \$625.11 list); **Example:** D821-2240-F

To specify, add -P to the end of the product number; **Example:** D821-2240-P (add \$63.85 list)

To specify, change the 2nd digit in the product number from an 8 to a 7 and specify the leather surface and color; **Example:** D821-2240 (chair with fabric); D721-2240 (chair with leather)

NOTE: CAL 133 is available on all chairs models in leather.

Stain repellent is not available on leather.

For available fabrics, refer to surfaces.haworth.com.

Monaco

Medium High-Back Chair with Enclosed Arms



D821-2640

Dimensions

SH: 16" - 20 1/2"
(406mm-521mm)
H: 45" - 52 1/2"
(1143mm-1334mm)
D: 23 1/2"(597mm)
W: 26"(660mm)
SW: 22"(559mm)
SD: 20"(508mm)
AH: 26 1/3" - 31 1/3"
(577mm-689mm)

Features

- Pneumatic height adjustment.
- Flexible headrest.
- Fully-upholstered shell.
- Standard with 6-position back lock.
- Five-star, cast aluminum base with dual-wheel casters.
- Casters and column standard in black finish color.
- Arms enclosed.
- Standard with 3"(76mm) of back height adjustment.
- COM yardage: 3.75
- COL square footage: 67.5

To Order, Specify:

- 1) Product number.
- 2) Fabric surface and color.
- 3) Base trim color. Add **\$87.20** for Brushed Aluminum (PN-B) finish.

NOTE:

CAD symbol for Value Packs shows one chair but represents quantity of chairs within Value Pack.

Arms/ Caps	Quantity	Number	Fabric Grade		C	D	E	F	G	H	Leather Grade A	Leather Grade B
			A	B								
Without Lumbar Support - Standard												
	1 chair	D821-2640	\$ 3207.87	\$ 3322.08	\$ 3392.09	\$ 3576.31	\$ 3658.59	\$ 4006.15	\$ 4176.85	\$ 4650.92	\$ 4550.21	\$ 5117.26
	6-chair Value Pack	D821-A640	18098.92	18784.18	19204.24	20309.56	20803.24	22888.60	23912.80	26757.22	26152.96	29555.26
	8-chair Value Pack	D821-B640	24125.35	25039.03	25599.11	27072.87	27731.11	30511.59	31877.19	35669.75	34864.07	39400.47
	10-chair Value Pack	D821-C640	30494.43	31636.53	32336.63	34178.83	35001.63	38477.23	40184.23	44924.93	43917.83	49588.33
With Lumbar Support - Standard												
	1 chair	D821-2641	\$ 3395.78	\$ 3509.99	\$ 3580.00	\$ 3764.22	\$ 3846.50	\$ 4194.06	\$ 4364.76	\$ 4838.83	\$ 4738.12	\$ 5305.17
	6-chair Value Pack	D821-A641	19226.38	19911.64	20331.70	21437.02	21930.70	24016.06	25040.26	27884.68	27280.42	30682.72
	8-chair Value Pack	D821-B641	25628.63	26542.31	27102.39	28576.15	29234.39	32014.87	33380.47	37173.03	36367.35	40903.75
	10-chair Value Pack	D821-C641	32373.53	33515.63	34215.73	36057.93	36880.73	40356.33	42063.33	46804.03	45796.93	51467.43

The following options require modification of the product number.

Soft Casters

CAL 133

Stain Repellent

Leather Upholstery

To specify, change the 7th digit from a **4** (hard caster) to a **2** (soft caster); **Example:** D821-2620

To specify, add **-F** to end of the product number (add **\$625.11** list); **Example:** D821-2640-**F**

To specify, add **-P** to the end of the product number; **Example:** D821-2640-**P** (add **\$63.85** list)

To specify, change the 2nd digit in the product number from an **8** to a **7** and specify the leather surface and color; **Example:** D821-2640 (chair with fabric); **D721-2640** (chair with leather)

NOTE: CAL 133 is available on all chairs models in leather.

Stain repellent is not available on leather.

For available fabrics, refer to surfaces.haworth.com.

Monaco

Large Mid-Back Chair with Open Arms



D831-2240

Dimensions

SH: 16" - 20 1/2"
(406mm-521mm)
H: 41 1/2" - 49 1/2"
(1054mm-1257mm)
D: 26"(660mm)
W: 30"(762mm)
SW: 23 1/2"(597mm)
SD: 21 1/2"(546mm)
AH: 26 1/3" - 31 1/3"
(577mm-689mm)

Features

- Pneumatic height adjustment.
- Fully-upholstered shell.
- Standard with 6-position back lock.
- Five-star, cast aluminum base with dual-wheel casters.
- Casters and column standard in black finish color.
- Arms available with standard black soft or upholstered caps.
- Standard with 3"(76mm) of back height adjustment.
- COM yardage: 3.25
- COL square footage: 58.5

To Order, Specify:

- 1) Product number.
- 2) Fabric surface and color.
- 3) Base and arm trim color. Add **\$87.20** for Brushed Aluminum (PN-B) finish.

NOTE:

CAD symbol for Value Packs shows one chair but represents quantity of chairs within Value Pack.

Arms/ Caps	Quantity	Number	Fabric Grade		C	D	E	F	G	H	Leather Grade A	Leather Grade B
			A	B								
Without Lumbar Support - Standard												
	1 chair	D831-2240	\$ 3074.00	\$ 3178.39	\$ 3244.70	\$ 3414.18	\$ 3489.10	\$ 3722.45	\$ 3834.22	\$ 4246.86	\$ 4291.08	\$ 4848.99
	6-chair Value Pack	D831-A240	17295.70	17922.04	18319.90	19336.78	19786.30	21186.40	21857.02	24332.86	24598.18	27945.64
	8-chair Value Pack	D831-B240	23054.39	23889.51	24419.99	25775.83	26375.19	28241.99	29136.15	32437.27	32791.03	37254.31
	10-chair Value Pack	D831-C240	29155.73	30199.63	30862.73	32557.53	33306.73	35640.23	36757.93	40884.33	41326.53	46905.63
Without Lumbar Support - Upholstered												
	1 chair	D831-2340	\$ 3152.59	\$ 3256.98	\$ 3323.29	\$ 3492.77	\$ 3567.69	\$ 3801.04	\$ 3912.81	\$ 4325.45	\$ 4369.67	\$ 4927.58
	6-chair Value Pack	D831-A340	17767.24	18393.58	18791.44	19808.32	20257.84	21657.94	22328.56	24804.40	25069.72	28417.18
	8-chair Value Pack	D831-B340	23683.11	24518.23	25048.71	26404.55	27003.91	28870.71	29764.87	33065.99	33419.75	37883.03
	10-chair Value Pack	D831-C340	29941.63	30985.53	31648.63	33343.43	34092.63	36426.13	37543.83	41670.23	42112.43	47691.53
With Lumbar Support - Standard												
	1 chair	D831-2241	\$ 3261.91	\$ 3366.30	\$ 3432.61	\$ 3602.09	\$ 3677.01	\$ 3910.36	\$ 4022.13	\$ 4434.77	\$ 4478.99	\$ 5036.90
	6-chair Value Pack	D831-A241	18423.16	19049.50	19447.36	20464.24	20913.76	22313.86	22984.48	25460.32	25725.64	29073.10
	8-chair Value Pack	D831-B241	24557.67	25392.79	25923.27	27279.11	27878.47	29745.27	30639.43	33940.55	34294.31	38757.59
	10-chair Value Pack	D831-C241	31034.83	32078.73	32741.83	34436.63	35185.83	37519.33	38637.03	42763.43	43205.63	48784.73
With Lumbar Support - Upholstered												
	1 chair	D831-2341	\$ 3340.50	\$ 3444.89	\$ 3511.20	\$ 3680.68	\$ 3755.60	\$ 3988.95	\$ 4100.72	\$ 4513.36	\$ 4557.58	\$ 5115.49
	6-chair Value Pack	D831-A341	18894.70	19521.04	19918.90	20935.78	21385.30	22785.40	23456.02	25931.86	26197.18	29544.64
	8-chair Value Pack	D831-B341	25186.39	26021.51	26551.99	27907.83	28507.19	30373.99	31268.15	34569.27	34923.03	39386.31
	10-chair Value Pack	D831-C341	31820.73	32864.63	33527.73	35222.53	35971.73	38305.23	39422.93	43549.33	43991.53	49570.63

The following options require modification of the product number.

Soft Casters
CAL 133
Stain Repellent
Leather Upholstery

To specify, change the 7th digit from a **4** (hard caster) to a **2** (soft caster); **Example:** D831-2220

To specify, add **-F** to end of the product number (add **\$625.11** list); **Example:** D831-2240-**F**

To specify, add **-P** to the end of the product number; **Example:** D831-2240-**P** (add **\$63.85** list)

To specify, change the 2nd digit in the product number from an **8** to a **7** and specify the leather surface and color; **Example:** D831-2240 (chair with fabric); D731-2240 (chair with leather)

NOTE: CAL 133 is available on all chairs models in leather.

Stain repellent is not available on leather.

For available fabrics, refer to surfaces.haworth.com.

Monaco

Large Mid-Back Chair with Enclosed Arms



D831-2640

Dimensions

SH: 16" - 20 1/2"
(406mm-521mm)
H: 41 1/2" - 49 1/2"
(1054mm-1257mm)
D: 26"(660mm)
W: 30"(762mm)
SW: 23 1/2"(597mm)
SD: 21 1/2"(546mm)
AH: 26 1/3" - 31 1/3"
(577mm-689mm)

Features

- Pneumatic height adjustment.
- Fully-upholstered shell.
- Standard with 6-position back lock.
- Five-star, cast aluminum base with dual-wheel casters.
- Casters and column standard in black finish color.
- Arms enclosed.
- Standard with 3"(76mm) of back height adjustment.
- COM yardage: 3.50
- COL square footage: 63.0

To Order, Specify:

- 1) Product number.
- 2) Fabric surface and color.
- 3) Base trim color. Add **\$87.20** for Brushed Aluminum (PN-B) finish.

NOTE:

CAD symbol for Value Packs shows one chair but represents quantity of chairs within Value Pack.

Arms/ Caps	Quantity	Number	Fabric Grade		C	D	E	F	G	H	Leather Grade A	Leather Grade B
			A	B								
Without Lumbar Support - Standard												
	1 chair	D831-2640	\$ 3074.00	\$ 3178.39	\$ 3244.70	\$ 3414.18	\$ 3489.10	\$ 3722.45	\$ 3834.22	\$ 4246.86	\$ 4291.08	\$ 4848.99
	6-chair Value Pack	D831-A640	17295.70	17922.04	18319.90	19336.78	19786.30	21186.40	21857.02	24332.86	24598.18	27945.64
	8-chair Value Pack	D831-B640	23054.39	23889.51	24419.99	25775.83	26375.19	28241.99	29136.15	32437.27	32791.03	37254.31
	10-chair Value Pack	D831-C640	29155.73	30199.63	30862.73	32557.53	33306.73	35640.23	36757.93	40884.33	41326.53	46905.63
With Lumbar Support - Standard												
	1 chair	D831-2641	\$ 3261.91	\$ 3366.30	\$ 3432.61	\$ 3602.09	\$ 3677.01	\$ 3910.36	\$ 4022.13	\$ 4434.77	\$ 4478.99	\$ 5036.90
	6-chair Value Pack	D831-A641	18423.16	19049.50	19447.36	20464.24	20913.76	22313.86	22984.48	25460.32	25725.64	29073.10
	8-chair Value Pack	D831-B641	24557.67	25392.79	25923.27	27279.11	27878.47	29745.27	30639.43	33940.55	34294.31	38757.59
	10-chair Value Pack	D831-C641	31034.83	32078.73	32741.83	34436.63	35185.83	37519.33	38637.03	42763.43	43205.63	48784.73

The following options require modification of the product number.

Soft Casters

CAL 133

Stain Repellent

Leather Upholstery

To specify, change the 7th digit from a 4 (hard caster) to a 2 (soft caster); **Example:** D831-2620

To specify, add -F to end of the product number (add **\$625.11** list); **Example:** D831-2640-F

To specify, add -P to the end of the product number; **Example:** D831-2640-P (add **\$63.85** list)

To specify, change the 2nd digit in the product number from an 8 to a 7 and specify the leather surface and color; **Example:** D831-2640 (chair with fabric); D731-2640 (chair with leather)

NOTE: CAL 133 is available on all chairs models in leather.

Stain repellent is not available on leather.

For available fabrics, refer to surfaces.haworth.com.

Monaco

Medium Mid-Back Chair with Open Arms



D841-2240

Dimensions

SH: 16" - 20 1/2"
(406mm-521mm)
H: 39" - 46 3/4"
(991mm-1187mm)
D: 23 1/2"(597mm)
W: 26"(660mm)
SW: 22"(559mm)
SD: 20"(508mm)
AH: 26 1/3" - 31 1/3"
(577mm-689mm)

Features

- Pneumatic height adjustment.
- Fully-upholstered shell.
- Standard with 6-position back lock.
- Five-star, cast aluminum base with dual-wheel casters.
- Casters and column standard in black finish color.
- Arms available with standard black soft or upholstered caps.
- Standard with 3"(76mm) of back height adjustment.
- COM yardage: 3.00
- COL square footage: 54.0

To Order, Specify:

- 1) Product number.
- 2) Fabric surface and color.
- 3) Base and arm trim color. Add **\$87.20** for Brushed Aluminum (PN-B) finish.

NOTE:

CAD symbol for Value Packs shows one chair but represents quantity of chairs within Value Pack.

Arms/ Caps	Quantity	Number	Fabric Grade								Leather Grade A	Leather Grade B
			A	B	C	D	E	F	G	H		
Without Lumbar Support - Standard												
	1 chair	D841-2240	\$ 3074.00	\$ 3178.39	\$ 3244.70	\$ 3414.18	\$ 3489.10	\$ 3722.45	\$ 3834.22	\$ 4246.86	\$ 4291.08	\$ 4848.99
	6-chair Value Pack	D841-A240	17295.70	17922.04	18319.90	19336.78	19786.30	21186.40	21857.02	24332.86	24598.18	27945.64
	8-chair Value Pack	D841-B240	23054.39	23889.51	24419.99	25775.83	26375.19	28241.99	29136.15	32437.27	32791.03	37254.31
	10-chair Value Pack	D841-C240	29155.73	30199.63	30862.73	32557.53	33306.73	35640.23	36757.93	40884.33	41326.53	46905.63
Without Lumbar Support - Upholstered												
	1 chair	D841-2340	\$ 3152.59	\$ 3256.98	\$ 3323.29	\$ 3492.77	\$ 3567.69	\$ 3801.04	\$ 3912.81	\$ 4325.45	\$ 4369.67	\$ 4927.58
	6-chair Value Pack	D841-A340	17767.24	18393.58	18791.44	19808.32	20257.84	21657.94	22328.56	24804.40	25069.72	28417.18
	8-chair Value Pack	D841-B340	23683.11	24518.23	25048.71	26404.55	27003.91	28870.71	29764.87	33065.99	33419.75	37883.03
	10-chair Value Pack	D841-C340	29941.63	30985.53	31648.63	33343.43	34092.63	36426.13	37543.83	41670.23	42112.43	47691.53
With Lumbar Support - Standard												
	1 chair	D841-2241	\$ 3261.91	\$ 3366.30	\$ 3432.61	\$ 3602.09	\$ 3677.01	\$ 3910.36	\$ 4022.13	\$ 4434.77	\$ 4478.99	\$ 5036.90
	6-chair Value Pack	D841-A241	18423.16	19049.50	19447.36	20464.24	20913.76	22313.86	22984.48	25460.32	25725.64	29073.10
	8-chair Value Pack	D841-B241	24557.67	25392.79	25923.27	27279.11	27878.47	29745.27	30639.43	33940.55	34294.31	38757.59
	10-chair Value Pack	D841-C241	31034.83	32078.73	32741.83	34436.63	35185.83	37519.33	38637.03	42763.43	43205.63	48784.73
With Lumbar Support - Upholstered												
	1 chair	D841-2341	\$ 3340.50	\$ 3444.89	\$ 3511.20	\$ 3680.68	\$ 3755.60	\$ 3988.95	\$ 4100.72	\$ 4513.36	\$ 4557.58	\$ 5115.49
	6-chair Value Pack	D841-A341	18894.70	19521.04	19918.90	20935.78	21385.30	22785.40	23456.02	25931.86	26197.18	29544.64
	8-chair Value Pack	D841-B341	25186.39	26021.51	26551.99	27907.83	28507.19	30373.99	31268.15	34569.27	34923.03	39386.31
	10-chair Value Pack	D841-C341	31820.73	32864.63	33527.73	35222.53	35971.73	38305.23	39422.93	43549.33	43991.53	49570.63

The following options require modification of the product number.

- Soft Casters
- CAL 133
- Stain Repellent
- Leather Upholstery

To specify, change the 7th digit from a 4 (hard caster) to a 2 (soft caster); **Example:** D841-2220

To specify, add -F to end of the product number (add \$625.11 list); **Example:** D841-2240-F

To specify, add -P to the end of the product number; **Example:** D841-2240-P (add \$63.85 list)

To specify, change the 2nd digit in the product number from an 8 to a 7 and specify the leather surface and color; **Example:** D841-2240 (chair with fabric); D741-2240 (chair with leather)

NOTE: CAL 133 is available on all chairs models in leather.

Stain repellent is not available on leather.

For available fabrics, refer to surfaces.haworth.com.

Monaco

Medium Mid-Back Chair with Enclosed Arms



D841-2640

Dimensions

SH: 16" - 20 1/2"
(406mm-521mm)
H: 39" - 46 3/4"
(991mm-1187mm)
D: 23 1/2"(597mm)
W: 26"(660mm)
SW: 22"(559mm)
SD: 20"(508mm)
AH: 26 1/3" - 31 1/3"
(577mm-689mm)

Features

- Pneumatic height adjustment.
- Fully-upholstered shell.
- Standard with 6-position back lock.
- Five-star, cast aluminum base with dual-wheel casters.
- Casters and column standard in black finish color.
- Arms enclosed.
- Standard with 3"(76mm) of back height adjustment.
- COM yardage: 3.25
- COL square footage: 58.5

To Order, Specify:

- 1) Product number.
- 2) Fabric surface and color.
- 3) Base trim color. Add **\$87.20** for Brushed Aluminum (PN-B) finish.

NOTE:

CAD symbol for Value Packs shows one chair but represents quantity of chairs within Value Pack.

Arms/ Caps	Quantity	Number	Fabric Grade		C	D	E	F	G	H	Leather Grade A	Leather Grade B
			A	B								
Without Lumbar Support - Standard												
	1 chair	D841-2640	\$ 3074.00	\$ 3178.39	\$ 3244.70	\$ 3414.18	\$ 3489.10	\$ 3722.45	\$ 3834.22	\$ 4246.86	\$ 4291.08	\$ 4848.99
	6-chair Value Pack	D841-A640	17295.70	17922.04	18319.90	19336.78	19786.30	21186.40	21857.02	24332.86	24598.18	27945.64
	8-chair Value Pack	D841-B640	23054.39	23889.51	24419.99	25775.83	26375.19	28241.99	29136.15	32437.27	32791.03	37254.31
	10-chair Value Pack	D841-C640	29155.73	30199.63	30862.73	32557.53	33306.73	35640.23	36757.93	40884.33	41326.53	46905.63
With Lumbar Support - Standard												
	1 chair	D841-2641	\$ 3261.91	\$ 3366.30	\$ 3432.61	\$ 3602.09	\$ 3677.01	\$ 3910.36	\$ 4022.13	\$ 4434.77	\$ 4478.99	\$ 5036.90
	6-chair Value Pack	D841-A641	18423.16	19049.50	19447.36	20464.24	20913.76	22313.86	22984.48	25460.32	25725.64	29073.10
	8-chair Value Pack	D841-B641	24557.67	25392.79	25923.27	27279.11	27878.47	29745.27	30639.43	33940.55	34294.31	38757.59
	10-chair Value Pack	D841-C641	31034.83	32078.73	32741.83	34436.63	35185.83	37519.33	38637.03	42763.43	43205.63	48784.73

The following options require modification of the product number.

- Soft Casters
- CAL 133
- Stain Repellent
- Leather Upholstery

To specify, change the 7th digit from a 4 (hard caster) to a 2 (soft caster); **Example:** D841-2620

To specify, add -F to end of the product number (add \$625.11 list); **Example:** D841-2640-F

To specify, add -P to the end of the product number; **Example:** D841-2640-P (add \$63.85 list)

To specify, change the 2nd digit in the product number from an 8 to a 7 and specify the leather surface and color; **Example:** D841-2640 (chair with fabric); D741-2640 (chair with leather)

NOTE: CAL 133 is available on all chairs models in leather.

Stain repellent is not available on leather.

For available fabrics, refer to surfaces.haworth.com.

Wood Seating

General Specifications

Features and Options

Guest, occasional, and lounge models feature frames constructed solid hardwood, laminated plywood, laminated hardwood core and premium veneers, or rigid polyurethane.

Office seating models feature an inner frame construction of tubular steel or solid hardwood or laminated plywood or molded plywood. Swivel bases are standard with hard dual-wheel casters.

Exposed wood surfaces are finished with two top coats of pre-catalyst nitrocellulose lacquer for a durable finish.

Refer to the appropriate seating model for applicable features and options.

COM & COL General Information

To order a COM fabric (Customer's Own Material), contact the Haworth Inquiry Center (1.800.426.8562), your local Haworth dealer, or go to haworth.com/surfaces > COM Library to find out if the COM you have selected has already been tested and approved. The surface collection site also has information on the Haworth + alliance program with Carnegie, Luna Textiles, and Maharam as well as our industry-leading Pre-Approved COM program.

COM fabrics are placed into Grades based on the cost per linear yard. If a fabric's cost exceeds the range of our highest Grade it will be noted as Non-Graded. The product will be priced at Grade A; the COM fabric costs will appear as a separate line item. The fabric charge will be Haworth's purchase cost plus a 4% administrative fee (based on the cost of the fabric). Yardage calculations will include any applicable fabric repeat.

COM Leather products will be priced at a leather Grade A; COL costs will appear as a separate line item. The leather costs will be Haworth's purchase cost plus a 4% administrative fee (based on the cost of the leather).

Flammability Requirements

Select chair models meet CAL 133 Standard and are available with an optional fire-retardant construction to comply with California Bulletin #133. Refer to the price pages for ordering information. Refer to Haworth.com/surfaces for a listing of the approved fabrics.

General Guidelines for Product Specification

Seating specification numbers are based on a numeric logic that identifies a product by model and certain characteristics.

For instance, a product number that reads **SAS-22-A1B** identifies the product as a Candor Classic Seating with fully upholstered seat and back.

The numeric logic for this model with finish codes is shown below:

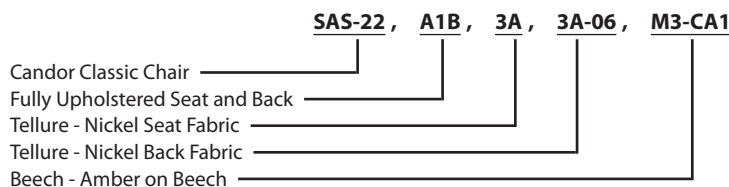

A ninth-digit suffix of the product code will indicate functional options, such as **-F** for CAL 133 option. There are exceptions to this logic; therefore, always refer to the price charts for product numbers rather than attempting to construct them. Product number modification instructions for additional options appear in footnoted copy for each applicable model.

Beyond the printed product number, fabric and finish codes are required to complete an order specification.

To communicate your order clearly, list the product number and finish codes in the sequence outlined on each price page.

Finishes and Fabrics

A complete listing of finishes/fabrics can be found in the back of the price list.

Candor Classic Seating

Number ① ②	Fabric Grade		C	D	E	F	G	H	Leather Grade A	Leather Grade B
	A	B								
SAS- ■ ■ -A1B	\$906.33	\$930.65	\$940.41	\$964.73	\$979.31	\$1147.21	\$1195.89	\$1341.85	\$1232.37	\$1522.73

Fully Upholstered
Seat and Back

SAS-22-A1B

Dimensions

SH: 17.8"(452mm)
H: 32.75"(832mm)
D: 23.25"(591mm)
W: 21"(533mm)
AH: 25"(635mm)
SW: 17.8"(452mm)
SD: 17.15"(436mm)

Features

- Open arms.
- Upholstered seat and back.
- Steamed beech hardwood frame. Seat frame rails are mortise and tenoned, cross locked with dowels, reinforced with corner blocks.
- Seat is HR foam over a webbed panel.
- The upholstered back frame insert is padded with foam.
- COM yardage: 1.5
- COL square footage: 27.0

To Order, Specify:

1) Product number, including:

① Seat Option:

- 1 Leather
- 2 Fabric
- 3 Faux Leather

② Back Option:

- 1 Leather
- 2 Fabric
- 3 Faux Leather

- 2) Fabric surface and color (seat).
- 3) Fabric surface and color (back).
- 4) Arm/frame finish color.

SAS- ■ ■ -A2B	\$906.33	\$930.65	\$940.41	\$964.73	\$979.31	\$1147.21	\$1195.89	\$1341.85	\$1232.37	\$1522.73
---------------	----------	----------	----------	----------	----------	-----------	-----------	-----------	-----------	-----------

Fully Upholstered
Seat and 3/4 Back

SAS-22-A2B

Dimensions

SH: 17.8"(452mm)
H: 32.50"(826mm)
D: 23.50"(597mm)
W: 21"(533mm)
AH: 25"(635mm)
SW: 17.8"(452mm)
SD: 17.15"(436mm)

Features

- Open arms.
- Upholstered seat and back.
- Steamed beech hardwood frame. Seat frame rails are mortise and tenoned, cross locked with dowels, reinforced with corner blocks.
- Seat is HR foam over a webbed panel.
- The upholstered back frame insert is padded with foam.
- COM yardage: 1.38
- COL square footage: 25.0

To Order, Specify:

1) Product number, including:

① Seat Option:

- 1 Leather
- 2 Fabric
- 3 Faux Leather

② Back Option:

- 1 Leather
- 2 Fabric
- 3 Faux Leather

- 2) Fabric surface and color (seat).
- 3) Fabric surface and color (back).
- 4) Arm/frame finish color.

SAS- ■ W-A4B	\$846.71	\$858.87	\$863.75	\$875.91	\$883.20	\$967.15	\$991.49	\$1064.47	\$1009.73	\$1154.91
--------------	----------	----------	----------	----------	----------	----------	----------	-----------	-----------	-----------

Fully Upholstered
Seat and Slat Back

SAS-2W-A4B

Dimensions

SH: 17.8"(452mm)
H: 32.50"(826mm)
D: 23.50"(597mm)
W: 21"(533mm)
AH: 25"(635mm)
SW: 17.8"(452mm)
SD: 19"(483mm)

Features

- Open arms.
- Upholstered seat.
- Steamed beech hardwood frame. Seat frame rails are mortise and tenoned, cross locked with dowels, reinforced with corner blocks.
- Seat is HR foam over a webbed panel.
- COM yardage: 0.88
- COL square footage: 16.0

To Order, Specify:

1) Product number, including:

① Seat Option:

- 1 Leather
- 2 Fabric
- 3 Faux Leather

② Back Option:

- W Wood

- 2) Fabric surface and color.
- 3) Arm/frame finish color.

The following options require modification of the product number.

CAL 133
Stain Repellent
Moisture Barrier with Stain Repellent

To specify, add **-F** to end of the product number (add \$115.58 list); **Example:** SAS-2W-A4B-F

To specify, add **-P** to the end of the product number; **Example:** SAS-2W-A4B-P (add \$37.71 list)

To specify, add **-D** to the end of the product number; **Example:** SAS-22-A1B-D (add \$49.87 list)

NOTE: Stain repellent and moisture barrier are not available on leather or faux leather.

For available fabrics, refer to surfaces.haworth.com.

Candor Modern Seating

Number 1 2	Fabric Grade		C	D	E	F	G	H	Leather	Leather
	A	B							Grade A	Grade B
SAS- ■ ■ -A1A	\$906.33	\$930.65	\$940.41	\$964.73	\$979.31	\$1147.21	\$1195.89	\$1341.85	\$1232.37	\$1522.73

Fully Upholstered
Seat and Back

SAS-22-A1A

Dimensions

SH: 17.8"(452mm)
H: 32.75"(832mm)
D: 23.50"(597mm)
W: 21"(533mm)
AH: 25"(635mm)
SW: 17.8"(452mm)
SD: 17"(432mm)

Features

- Open arms.
- Upholstered seat and back.
- Steamed beech hardwood frame. Seat frame rails are mortise and tenoned, cross locked with dowels, reinforced with corner blocks.
- Seat is HR foam over a webbed panel.
- The upholstered back frame insert is padded with foam.
- COM yardage: 1.5
- COL square footage: 27.0

To Order, Specify:

- 1) Product number, including:

1 Seat Option:

- 1 Leather
- 2 Fabric
- 3 Faux Leather

2 Back Option:

- 1 Leather
- 2 Fabric
- 3 Faux Leather

- 2) Fabric surface and color (seat).
- 3) Fabric surface and color (back).
- 4) Arm/frame finish color.

SAS- ■ ■ -A3A	\$906.33	\$930.65	\$940.41	\$964.73	\$979.31	\$1147.21	\$1195.89	\$1341.85	\$1232.37	\$1522.73
---------------	----------	----------	----------	----------	----------	-----------	-----------	-----------	-----------	-----------

Fully Upholstered
Seat and 1/2 Back

SAS-22-A3A

Dimensions

SH: 17.8"(452mm)
H: 32.50"(826mm)
D: 23"(584mm)
W: 21"(533mm)
AH: 25"(635mm)
SW: 17.8"(452mm)
SD: 17"(432mm)

Features

- Open arms.
- Upholstered seat and back.
- Steamed beech hardwood frame. Seat frame rails are mortise and tenoned, cross locked with dowels, reinforced with corner blocks.
- Seat is HR foam over a webbed panel.
- The upholstered back frame insert is padded with foam.
- COM yardage: 1.25
- COL square footage: 22.5

To Order, Specify:

- 1) Product number, including:

1 Seat Option:

- 1 Leather
- 2 Fabric
- 3 Faux Leather

2 Back Option:

- 1 Leather
- 2 Fabric
- 3 Faux Leather

- 2) Fabric surface and color (seat).
- 3) Fabric surface and color (back).
- 4) Arm/frame finish color.

SAS- ■ W-A4A	\$846.71	\$858.87	\$863.75	\$875.91	\$883.20	\$967.15	\$991.49	\$1064.47	\$1009.73	\$1154.91
--------------	----------	----------	----------	----------	----------	----------	----------	-----------	-----------	-----------

Fully Upholstered
Seat and Slat Back

SAS-2W-A4A

Dimensions

SH: 17.8"(452mm)
H: 32.50"(826mm)
D: 23"(584mm)
W: 21"(533mm)
AH: 25"(635mm)
SW: 17.8"(452mm)
SD: 19"(483mm)

Features

- Open arms.
 - Upholstered seat.
 - Steamed beech hardwood frame. Seat frame rails are mortise and tenoned, cross locked with dowels, reinforced with corner blocks.
 - Seat is HR foam over a webbed panel.
 - COM yardage: 0.88
 - COL square footage: 16.0
- Available on RUSH with matching seat and back upholstery.

To Order, Specify:

- 1) Product number, including:

1 Seat Option:

- 1 Leather
- 2 Fabric
- 3 Faux Leather

2 Back Option:

- W Wood

- 2) Fabric surface and color.
- 3) Arm/frame finish color.

The following options require modification of the product number.

CAL 133
Stain Repellent
Moisture Barrier with Stain Repellent

To specify, add **-F** to end of the product number (add \$115.58 list); **Example:** SAS-2W-A4A-F
To specify, add **-P** to the end of the product number; **Example:** SAS-2W-A4A-P (add \$37.71 list)
To specify, add **-D** to the end of the product number; **Example:** SAS-22-A1A-D (add \$49.87 list)

NOTE: Stain repellent and moisture barrier are not available on leather or faux leather.

For available fabrics, refer to surfaces.haworth.com.

Composites Seating Series

Guest/Occasional Seating

Base/ Frame	Number	Fabric Grade		C	D	E	F	G	H	Leather Grade A	Leather Grade B
		A	B								
Maple	4045-00	\$1158.14	\$1198.29	\$1234.78	\$1295.60	\$1332.09	\$1355.21	\$1397.79	\$1515.79	\$1947.68	\$2137.17

**Arc Arm,
Upholstered Back**

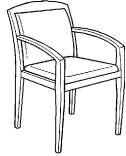

4045-00

Dimensions

SH: 18 1/2"(470mm)
H: 33 3/4"(857mm)
D: 23"(584mm)
W: 22 3/8"(568mm)
AH: 24" - 26"
(610mm-660mm)
SW: 19 1/2"(495mm)
SD: 18"(457mm)

Features

- Open arms.
- Upholstered seat and back.
- Maple hardwood frame. Seat frame rails are mortise and tenoned, cross locked with dowels, reinforced with corner blocks.
- Seat is HR foam over a webbed panel.
- The upholstered back frame insert is webbed and padded with foam.
- Available with fire-retardant construction to comply with California Bulletin #133.
- COM yardage: 1.25
- COL square footage: 22.5

To Order, Specify:

- 1) Product number.
- 2) Fabric surface and color.
- 3) Arm/frame finish color.

Maple	4145-00	\$1158.14	\$1182.47	\$1192.20	\$1218.96	\$1234.78	\$1288.30	\$1317.50	\$1394.14	\$1510.94	\$1671.41
-------	---------	-----------	-----------	-----------	-----------	-----------	-----------	-----------	-----------	-----------	-----------

**Arc Arm,
Circle Back**

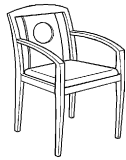

4145-00

Dimensions

SH: 18 1/2"(470mm)
H: 33 3/4"(857mm)
D: 23"(584mm)
W: 22 3/8"(568mm)
AH: 24" - 26"
(610mm-660mm)
SW: 19 1/2"(495mm)
SD: 18"(457mm)

Features

- Open arms.
- Upholstered seat.
- Maple hardwood frame. Seat frame rails are mortise and tenoned, cross locked with dowels, reinforced with corner blocks.
- Seat is HR foam over a webbed panel.
- Available with fire-retardant construction to comply with California Bulletin #133.
- COM yardage: 0.66
- COL square footage: 12.0

To Order, Specify:

- 1) Product number.
- 2) Fabric surface and color.
- 3) Arm/frame finish color.

Maple	4245-00	\$1158.14	\$1182.47	\$1192.20	\$1218.96	\$1234.78	\$1288.30	\$1317.50	\$1394.14	\$1510.94	\$1671.41
-------	---------	-----------	-----------	-----------	-----------	-----------	-----------	-----------	-----------	-----------	-----------

**Arc Arm,
Slat Back**



4245-00

Dimensions

SH: 18 1/2"(470mm)
H: 33 3/4"(857mm)
D: 23"(584mm)
W: 22 3/8"(568mm)
AH: 24" - 26"
(610mm-660mm)
SW: 19 1/2"(495mm)
SD: 18"(457mm)

Features

- Open arms.
- Upholstered seat.
- Maple hardwood frame. Seat frame rails are mortise and tenoned, cross locked with dowels, reinforced with corner blocks.
- Seat is HR foam over a webbed panel.
- Available with fire-retardant construction to comply with California Bulletin #133.
- COM yardage: 0.66
- COL square footage: 12.0

To Order, Specify:

- 1) Product number.
- 2) Fabric surface and color.
- 3) Arm/frame finish color.

The following options require modification of the product number.

CAL 133
Stain Repellent
Moisture Barrier with Stain Repellent

To specify, add **-F** to end of the product number (add **\$119.22** list); **Example:** 4245-00-**F**
To specify, add **-P** to the end of the product number; **Example:** 4245-00-**P** (add **\$37.71** list)
To specify, add **-D** to the end of the product number; **Example:** 4245-00-**D** (add **\$49.87** list)

NOTE: Stain repellent and moisture barrier are not available on leather or faux leather.
For available fabrics, refer to surfaces.haworth.com.

Composites Seating Series

Guest/Occasional Seating

Base/ Frame	Number	Fabric Grade		C	D	E	F	G	H	Leather Grade A	Leather Grade B
		A	B								
Maple	4046-00	\$1158.14	\$1198.29	\$1234.78	\$1295.60	\$1332.09	\$1355.21	\$1397.79	\$1515.79	\$1947.68	\$2137.17

**Repose Arm,
Upholstered Back**

4046-00

Dimensions

SH: 18 1/2"(470mm)
H: 33 3/4"(857mm)
D: 23"(584mm)
W: 22 3/8"(568mm)
AH: 25 1/2"(648mm)
SW: 19 1/2"(495mm)
SD: 18"(457mm)

Features

- Open arms.
- Upholstered seat and back.
- Maple hardwood frame. Seat frame rails are mortise and tenoned, cross locked with dowels, reinforced with corner blocks.
- Seat is HR foam over a webbed panel.
- The upholstered back frame insert is webbed and padded with foam.
- Available with fire-retardant construction to comply with California Bulletin #133.
- COM yardage: 1.25
- COL square footage: 22.5

To Order, Specify:

- 1) Product number.
- 2) Fabric surface and color.
- 3) Arm/frame finish color.

Maple	4146-00	\$1158.14	\$1182.47	\$1192.20	\$1218.96	\$1234.78	\$1288.30	\$1317.50	\$1394.14	\$1510.94	\$1671.41
-------	---------	-----------	-----------	-----------	-----------	-----------	-----------	-----------	-----------	-----------	-----------

**Repose Arm,
Hourglass Back**

4146-00

Dimensions

SH: 18 1/2"(470mm)
H: 33 3/4"(857mm)
D: 23"(584mm)
W: 22 3/8"(568mm)
AH: 25 1/2"(648mm)
SW: 19 1/2"(495mm)
SD: 18"(457mm)

Features

- Open arms.
- Upholstered seat.
- Maple hardwood frame. Seat frame rails are mortise and tenoned, cross locked with dowels, reinforced with corner blocks.
- Seat is HR foam over a webbed panel.
- Available with fire-retardant construction to comply with California Bulletin #133.
- COM yardage: 0.66
- COL square footage: 12.0

To Order, Specify:

- 1) Product number.
- 2) Fabric surface and color.
- 3) Arm/frame finish color.

Maple	4246-00	\$1158.14	\$1182.47	\$1192.20	\$1218.96	\$1234.78	\$1288.30	\$1317.50	\$1394.14	\$1510.94	\$1671.41
-------	---------	-----------	-----------	-----------	-----------	-----------	-----------	-----------	-----------	-----------	-----------

**Repose Arm,
Cross Back**

4246-00

Dimensions

SH: 18 1/2"(470mm)
H: 33 3/4"(857mm)
D: 23"(584mm)
W: 22 3/8"(568mm)
AH: 25 1/2"(648mm)
SW: 19 1/2"(495mm)
SD: 18"(457mm)

Features

- Open arms.
- Upholstered seat.
- Maple hardwood frame. Seat frame rails are mortise and tenoned, cross locked with dowels, reinforced with corner blocks.
- Seat is HR foam over a webbed panel.
- Available with fire-retardant construction to comply with California Bulletin #133.
- COM yardage: 0.66
- COL square footage: 12.0

To Order, Specify:

- 1) Product number.
- 2) Fabric surface and color.
- 3) Arm/frame finish color.

The following options require modification of the product number.

CAL 133

Stain Repellent

Moisture Barrier with Stain Repellent

To specify, add **-F** to end of the product number (add **\$119.22** list); **Example:** 4046-00-**F**To specify, add **-P** to the end of the product number; **Example:** 4046-00-**P** (add **\$37.71** list)To specify, add **-D** to the end of the product number; **Example:** 4046-00-**D** (add **\$49.87** list)

NOTE: Stain repellent and moisture barrier are not available on leather or faux leather.

For available fabrics, refer to surfaces.haworth.com.

Composites Seating Series

Guest/Occasional Seating

Base/ Frame	Number	Fabric Grade		C	D	E	F	G	H	Leather Grade A	Leather Grade B
		A	B								
Maple	4047-00	\$1158.14	\$1198.29	\$1234.78	\$1295.60	\$1332.09	\$1355.21	\$1397.79	\$1515.79	\$1947.68	\$2137.17

Cascade Arm, Upholstered Back

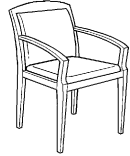

4047-00

Dimensions

SH: 18 1/2"(470mm)
H: 33 3/4"(857mm)
D: 23"(584mm)
W: 22 3/8"(568mm)
AH: 22 1/2" - 26 1/4"
(572mm-667mm)
SW: 19 1/2"(495mm)
SD: 18"(457mm)

Features

- Open arms.
- Upholstered seat and back.
- Maple hardwood frame. Seat frame rails are mortise and tenoned, cross locked with dowels, reinforced with corner blocks.
- Seat is HR foam over a webbed panel.
- The upholstered back frame insert is webbed and padded with foam.
- Available with fire-retardant construction to comply with California Bulletin #133.
- COM yardage: 1.25
- COL square footage: 22.5

To Order, Specify:

- 1) Product number.
- 2) Fabric surface and color.
- 3) Arm/frame finish color.

Maple	4147-00	\$1158.14	\$1182.47	\$1192.20	\$1218.96	\$1234.78	\$1288.30	\$1317.50	\$1394.14	\$1510.94	\$1671.41
-------	---------	-----------	-----------	-----------	-----------	-----------	-----------	-----------	-----------	-----------	-----------

Cascade Arm, Circle Back

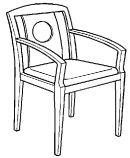

4147-00

Dimensions

SH: 18 1/2"(470mm)
H: 33 3/4"(857mm)
D: 23"(584mm)
W: 22 3/8"(568mm)
AH: 22 1/2" - 26 1/4"
(572mm-667mm)
SW: 19 1/2"(495mm)
SD: 18"(457mm)

Features

- Open arms.
- Upholstered seat.
- Maple hardwood frame. Seat frame rails are mortise and tenoned, cross locked with dowels, reinforced with corner blocks.
- Seat is HR foam over a webbed panel.
- Available with fire-retardant construction to comply with California Bulletin #133.
- COM yardage: 0.66
- COL square footage: 12.0

To Order, Specify:

- 1) Product number.
- 2) Fabric surface and color.
- 3) Arm/frame finish color.

Maple	4247-00	\$1158.14	\$1182.47	\$1192.20	\$1218.96	\$1234.78	\$1288.30	\$1317.50	\$1394.14	\$1510.94	\$1671.41
-------	---------	-----------	-----------	-----------	-----------	-----------	-----------	-----------	-----------	-----------	-----------

Cascade Arm, Slat Back

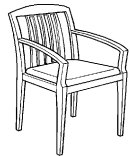

4247-00

Dimensions

SH: 18 1/2"(470mm)
H: 33 3/4"(857mm)
D: 23"(584mm)
W: 22 3/8"(568mm)
AH: 22 1/2" - 26 1/4"
(572mm-667mm)
SW: 19 1/2"(495mm)
SD: 18"(457mm)

Features

- Open arms.
- Upholstered seat.
- Maple hardwood frame. Seat frame rails are mortise and tenoned, cross locked with dowels, reinforced with corner blocks.
- Seat is HR foam over a webbed panel.
- Available with fire-retardant construction to comply with California Bulletin #133.
- COM yardage: 0.66
- COL square footage: 12.0

To Order, Specify:

- 1) Product number.
- 2) Fabric surface and color.
- 3) Arm/frame finish color.

The following options require modification of the product number.

CAL 133

Stain Repellent

Moisture Barrier with Stain Repellent

To specify, add **-F** to end of the product number (add **\$119.22** list); **Example:** 4047-00-**F**To specify, add **-P** to the end of the product number; **Example:** 4047-00-**P** (add **\$37.71** list)To specify, add **-D** to the end of the product number; **Example:** 4047-00-**D** (add **\$49.87** list)

NOTE: Stain repellent and moisture barrier are not available on leather or faux leather.

For available fabrics, refer to surfaces.haworth.com.

Composites Seating Series

Guest/Occasional Seating

Base/ Frame	Number	Fabric Grade								Leather Grade A	Leather Grade B
		A	B	C	D	E	F	G	H		
Maple	4048-00	\$1158.14	\$1198.29	\$1234.78	\$1295.60	\$1332.09	\$1355.21	\$1397.79	\$1515.79	\$1947.68	\$2137.17

**Contour Arm,
Upholstered Back**

4048-00

Dimensions

SH: 18 1/2"(470mm)
H: 33 3/4"(857mm)
D: 23"(584mm)
W: 22 3/8"(568mm)
AH: 22 7/8"-26-3/8"
(581mm-670mm)
SW: 19 1/2"(495mm)
SD: 18"(457mm)

Features

- Open arms.
- Upholstered seat and back.
- Maple hardwood frame. Seat frame rails are mortise and tenoned, cross locked with dowels, reinforced with corner blocks.
- Seat is HR foam over a webbed panel.
- The upholstered back frame insert is webbed and padded with foam.
- Available with fire-retardant construction to comply with California Bulletin #133.
- COM yardage: 1.25
- COL square footage: 22.5

To Order, Specify:

- 1) Product number.
- 2) Fabric surface and color.
- 3) Arm/frame finish color.

Maple	4148-00	\$1158.14	\$1182.47	\$1192.20	\$1218.96	\$1234.78	\$1288.30	\$1317.50	\$1394.14	\$1510.94	\$1671.41
-------	---------	-----------	-----------	-----------	-----------	-----------	-----------	-----------	-----------	-----------	-----------

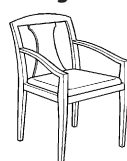
**Contour Arm,
Hourglass Back**

4148-00

Dimensions

SH: 18 1/2"(470mm)
H: 33 3/4"(857mm)
D: 23"(584mm)
W: 22 3/8"(568mm)
AH: 22 7/8"-26-3/8"
(581mm-670mm)
SW: 19 1/2"(495mm)
SD: 18"(457mm)

Features

- Open arms.
- Upholstered seat.
- Maple hardwood frame. Seat frame rails are mortise and tenoned, cross locked with dowels, reinforced with corner blocks.
- Seat is HR foam over a webbed panel.
- Available with fire-retardant construction to comply with California Bulletin #133.
- COM yardage: 0.66
- COL square footage: 12.0

To Order, Specify:

- 1) Product number.
- 2) Fabric surface and color.
- 3) Arm/frame finish color.

Maple	4248-00	\$1158.14	\$1182.47	\$1192.20	\$1218.96	\$1234.78	\$1288.30	\$1317.50	\$1394.14	\$1510.94	\$1671.41
-------	---------	-----------	-----------	-----------	-----------	-----------	-----------	-----------	-----------	-----------	-----------

**Contour Arm,
Cross Back**

4248-00

Dimensions

SH: 18 1/2"(470mm)
H: 33 3/4"(857mm)
D: 23"(584mm)
W: 22 3/8"(568mm)
AH: 22 7/8"-26-3/8"
(581mm-670mm)
SW: 19 1/2"(495mm)
SD: 18"(457mm)

Features

- Open arms.
- Upholstered seat.
- Maple hardwood frame. Seat frame rails are mortise and tenoned, cross locked with dowels, reinforced with corner blocks.
- Seat is HR foam over a webbed panel.
- Available with fire-retardant construction to comply with California Bulletin #133.
- COM yardage: 0.66
- COL square footage: 12.0

To Order, Specify:

- 1) Product number.
- 2) Fabric surface and color.
- 3) Arm/frame finish color.

The following options require modification of the product number.

CAL 133

Stain Repellent

Moisture Barrier with Stain Repellent

To specify, add **-F** to end of the product number (add **\$119.22** list); **Example:** 4048-00-**F**To specify, add **-P** to the end of the product number; **Example:** 4048-00-**P** (add **\$37.71** list)To specify, add **-D** to the end of the product number; **Example:** 4048-00-**D** (add **\$49.87** list)

NOTE: Stain repellent and moisture barrier are not available on leather or faux leather.

For available fabrics, refer to surfaces.haworth.com.

Composites Seating Series

Guest/Occasional Seating

Base/ Frame	Number	Fabric Grade		C	D	E	F	G	H	Leather Grade A	Leather Grade B
		A	B								
Maple	4043-00	\$1158.14	\$1198.29	\$1234.78	\$1295.60	\$1332.09	\$1355.21	\$1397.79	\$1515.79	\$1947.68	\$2137.17

Stacking Chair, Arc Arm, Upholstered Back

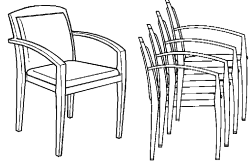

4043-00

Dimensions

SH: 18 1/2" (470mm)
 H: 33 5/8" (854mm)
 D: 21 3/4" (552mm)
 W: 22 1/4" (565mm)
 SW: 18" (457mm)
 SD: 18" (457mm)
 AH: 25 7/8" (657mm)

Features

- Open arms.
- Upholstered seat and back.
- Maple hardwood frame. Seat frame rails are mortise and tenoned, cross locked with dowels, reinforced with corner blocks.
- Seat is HR foam over a webbed panel.
- The upholstered back frame insert is webbed and padded with foam.
- Recommended stacking limit is 4 chairs high.
- Available with fire-retardant construction to comply with California Bulletin #133.
- COM yardage: 1.13
- COL square footage: 20.3

To Order, Specify:

- 1) Product number.
- 2) Fabric surface and color.
- 3) Frame finish color.

Maple	4243-00	\$1158.14	\$1182.47	\$1192.20	\$1218.96	\$1234.78	\$1288.30	\$1317.50	\$1394.14	\$1510.94	\$1671.41
-------	---------	-----------	-----------	-----------	-----------	-----------	-----------	-----------	-----------	-----------	-----------

Stacking Chair, Arc Arm, Slat Back

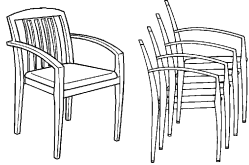

4243-00

Dimensions

SH: 18 1/2" (470mm)
 H: 33 5/8" (854mm)
 D: 21 3/4" (552mm)
 W: 22 1/4" (565mm)
 SW: 18" (457mm)
 SD: 18" (457mm)
 AH: 25 7/8" (657mm)

Features

- Open arms.
- Upholstered seat.
- Maple hardwood frame. Seat frame rails are mortise and tenoned, cross locked with dowels, reinforced with corner blocks.
- Seat is HR foam over a webbed panel.
- Recommended stacking limit is 4 chairs high.
- Available with fire-retardant construction to comply with California Bulletin #133.
- COM yardage: 0.66
- COL square footage: 12.0

To Order, Specify:

- 1) Product number.
- 2) Fabric surface and color.
- 3) Frame finish color.

The following options require modification of the product number.

CAL 133

Stain Repellent

Moisture Barrier with Stain Repellent

To specify, add **-F** to end of the product number (add **\$119.22** list); **Example:** 4043-00-**F**To specify, add **-P** to the end of the product number; **Example:** 4043-00-**P** (add **\$37.71** list)To specify, add **-D** to the end of the product number; **Example:** 4043-00-**D** (add **\$49.87** list)

NOTE: Stain repellent and moisture barrier are not available on leather or faux leather.

For available fabrics, refer to surfaces.haworth.com.

Composites Seating Series

Occasional Seating

Base/ Frame	Number	Fabric Grade		C	D	E	F	G	H	Leather Grade A	Leather Grade B
		A	B								
Maple	4049-00	\$1158.14	\$1198.29	\$1234.78	\$1295.60	\$1332.09	\$1355.21	\$1397.79	\$1515.79	\$1947.68	\$2137.17

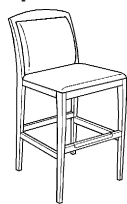
**Stool, Armless,
Upholstered Back**

4049-00

Dimensions

SH: 28"(711mm)
H: 41 1/8"(1045mm)
D: 19 7/8"(505mm)
W: 18 1/2"(470mm)
SW: 18 1/2"(470mm)
SD: 15 1/4"(387mm)

Features

- Upholstered seat and back.
- Maple hardwood frame. Seat frame rails are mortise and tenoned, cross locked with dowels, reinforced with corner blocks.
- Seat is HR foam over a webbed panel.
- The upholstered back frame insert is webbed and padded with foam.
- Standard with brass kick plate. No finish specification required.
- Available with fire-retardant construction to comply with California Bulletin #133.
- COM yardage: 1.00
- COL square footage: 18.0

To Order, Specify:

- 1) Product number.
- 2) Fabric surface and color.
- 3) Frame finish color.

Maple	4249-00	\$1158.14	\$1182.47	\$1192.20	\$1218.96	\$1234.78	\$1288.30	\$1317.50	\$1394.14	\$1510.94	\$1671.41
-------	---------	-----------	-----------	-----------	-----------	-----------	-----------	-----------	-----------	-----------	-----------

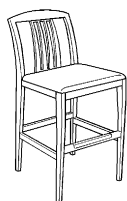
**Stool, Armless,
Slat Back**

4249-00

Dimensions

SH: 28"(711mm)
H: 41 1/8"(1045mm)
D: 19 7/8"(505mm)
W: 18 1/2"(470mm)
SW: 18 1/2"(470mm)
SD: 15 1/4"(387mm)

Features

- Upholstered seat.
- Maple hardwood frame. Seat frame rails are mortise and tenoned, cross locked with dowels, reinforced with corner blocks.
- Seat is HR foam over a webbed panel.
- Standard with brass kick plate. No finish specification required.
- Available with fire-retardant construction to comply with California Bulletin #133.
- COM yardage: 0.66
- COL square footage: 12.0

To Order, Specify:

- 1) Product number.
- 2) Fabric surface and color.
- 3) Frame finish color.

The following options require modification of the product number.

CAL 133

Stain Repellent

Moisture Barrier with Stain Repellent

To specify, add **-F** to end of the product number (add **\$119.22** list); **Example:** 4049-00-**F**
To specify, add **-P** to the end of the product number; **Example:** 4049-00-**P** (add **\$37.71** list)
To specify, add **-D** to the end of the product number; **Example:** 4049-00-**D** (add **\$49.87** list)

NOTE: Stain repellent and moisture barrier are not available on leather or faux leather.

For available fabrics, refer to surfaces.haworth.com.

Forenze Seating

Guest/Occasional Seating

Base/ Frame	Number	Fabric Grade		C	D	E	F	G	H	Leather	Leather
		A	B							Grade A	Grade B
Maple	8181-00	\$1243.30	\$1282.23	\$1317.51	\$1374.67	\$1411.17	\$1491.47	\$1543.77	\$1690.99	\$1995.14	\$2196.83

**Serpentine Arm,
Upholstered Back**

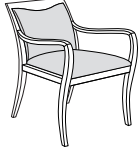

8181-00

Dimensions

- SH: 18 1/4"(464mm)
- H: 32 5/8"(829mm)
- D: 23 1/4"(591mm)
- W: 22 3/4"(578mm)
- AH: 26 1/2"(673mm)
- SW: 19 1/2"(495mm)
- SD: 18 1/4"(464mm)

Features

- Open arms.
- Upholstered seat and back.
- Maple hardwood frame. Seat frame rails are mortise and tenoned, cross locked with dowels.
- Seat is 1 3/4"(45mm) HR foam over a webbed panel.
- The upholstered back frame insert is webbed and padded with 1"(25mm) thick foam.
- COM yardage: 1.25
- COL square footage: 22.5

To Order, Specify:

- 1) Product number.
- 2) Fabric surface and color.
- 3) Wood finish color.

The following options require modification of the product number.

CAL 133

Stain Repellent

Moisture Barrier with Stain Repellent

To specify, add **-F** to end of the product number (add **\$109.49** list); **Example:** 8181-00-**F**

To specify, add **-P** to the end of the product number; **Example:** 8181-00-**P** (add **\$37.71** list)

To specify, add **-D** to the end of the product number; **Example:** 8381-00-**D** (add **\$49.87** list)

NOTE: Stain repellent and moisture barrier are not available on leather or faux leather.

For available fabrics, refer to surfaces.haworth.com.

Forenze Seating

Guest/Occasional Seating

Base/ Frame	Number	Fabric Grade		C	D	E	F	G	H	Leather Grade A	Leather Grade B
		A	B								
Maple	8182-00	\$1243.30	\$1282.23	\$1317.51	\$1374.67	\$1411.17	\$1491.47	\$1543.77	\$1690.99	\$1995.14	\$2196.83

Curve Arm,
Upholstered Back

8182-00

Dimensions

SH: 18 1/4"(464mm)
 H: 32 5/8"(829mm)
 D: 23 1/4"(591mm)
 W: 22 3/4"(578mm)
 AH: 26 3/8"(670mm)
 SW: 19 1/2"(495mm)
 SD: 18 1/4"(464mm)

Features

- Open arms.
- Upholstered seat and back.
- Maple hardwood frame. Seat frame rails are mortise and tenoned, cross locked with dowels.
- Seat is 1 3/4"(45mm) HR foam over a webbed panel.
- The upholstered back frame insert is webbed and padded with 1"(25mm) thick foam.
- COM yardage: 1.25
- COL square footage: 22.5

To Order, Specify:

- 1) Product number.
- 2) Fabric surface and color.
- 3) Wood finish color.

The following options require modification of the product number.

CAL 133

Stain Repellent

Moisture Barrier with Stain Repellent

To specify, add **-F** to end of the product number (add **\$109.49** list); **Example:** 8182-00-**F**

To specify, add **-P** to the end of the product number; **Example:** 8182-00-**P** (add **\$37.71** list)

To specify, add **-D** to the end of the product number; **Example:** 8182-00-**D** (add **\$49.87** list)

NOTE: Stain repellent and moisture barrier are not available on leather or faux leather.

For available fabrics, refer to surfaces.haworth.com.

Forenze Seating

Guest/Occasional Seating

Base/ Frame	Number	Fabric Grade		C	D	E	F	G	H	Leather Grade A	Leather Grade B
		A	B								
Maple	8483-00	\$1243.30	\$1266.41	\$1276.15	\$1300.47	\$1317.50	\$1440.38	\$1482.95	\$1600.97	\$1576.64	\$1734.55

Scroll Arm,
Slat Back

8483-00

Dimensions

SH: 18 1/4"(464mm)
 H: 32 5/8"(829mm)
 D: 22 3/4"(578mm)
 W: 22 3/4"(578mm)
 AH: 26 3/8"(670mm)
 SW: 19 1/2"(495mm)
 SD: 18 5/8"(473mm)

Features

- Open arms.
- Upholstered seat.
- Maple hardwood frame. Seat frame rails are mortise and tenoned, cross locked with dowels.
- Seat is 1 3/4"(45mm) HR foam over a webbed panel.
- COM yardage: 0.75
- COL square footage: 13.5

To Order, Specify:

- 1) Product number.
- 2) Fabric surface and color.
- 3) Wood finish color

Maple	8183-00	\$1243.30	\$1282.23	\$1317.51	\$1374.67	\$1411.17	\$1491.47	\$1543.77	\$1690.99	\$1995.14	\$2196.83
-------	---------	-----------	-----------	-----------	-----------	-----------	-----------	-----------	-----------	-----------	-----------

Scroll Arm,
Upholstered Back

8183-00

Dimensions

SH: 18 1/4"(464mm)
 H: 32 5/8"(829mm)
 D: 23 1/4"(591mm)
 W: 22 3/4"(578mm)
 AH: 26 3/8"(670mm)
 SW: 19 1/2"(495mm)
 SD: 18 1/4"(464mm)

Features

- Open arms.
- Upholstered seat and back.
- Maple hardwood frame. Seat frame rails are mortise and tenoned, cross locked with dowels.
- Seat is 1 3/4"(45mm) HR foam over a webbed panel.
- The upholstered back frame insert is webbed and padded with 1"(25mm) thick foam.
- COM yardage: 1.25
- COL square footage: 22.5

To Order, Specify:

- 1) Product number.
- 2) Fabric surface and color.
- 3) Wood finish color.

The following options require modification of the product number.

CAL 133
 Stain Repellent
 Moisture Barrier with Stain Repellent

To specify, add **-F** to end of the product number (add **\$109.49** list); **Example:** 8483-00-**F**
 To specify, add **-P** to the end of the product number; **Example:** 8483-00-**P** (add **\$37.71** list)
 To specify, add **-D** to the end of the product number; **Example:** 8483-00-**D** (add **\$49.87** list)

NOTE: Stain repellent and moisture barrier are not available on leather or faux leather.

For available fabrics, refer to surfaces.haworth.com.

Forenze Seating

Guest/Occasional Seating

Base/ Frame	Number	Fabric Grade		C	D	E	F	G	H	Leather Grade A	Leather Grade B
		A	B								
Maple	8484-00	\$1243.30	\$1266.41	\$1276.15	\$1300.47	\$1317.50	\$1440.38	\$1482.95	\$1600.97	\$1576.64	\$1734.55

**Cabriole Arm,
Slat Back**

8484-00

Dimensions

SH: 18 1/4"(464mm)
H: 32 5/8"(829mm)
D: 22 3/4"(578mm)
W: 22 3/4"(578mm)
AH: 26 1/2"(673mm)
SW: 19 1/2"(495mm)
SD: 18 5/8"(473mm)

Features

- Open arms.
- Upholstered seat.
- Maple hardwood frame. Seat frame rails are mortise and tenoned, cross locked with dowels.
- Seat is 1 3/4"(45mm) HR foam over a webbed panel.
- COM yardage: 0.75
- COL square footage: 13.5

To Order, Specify:

- 1) Product number.
- 2) Fabric surface and color.
- 3) Wood finish color.

Maple	8184-00	\$1243.30	\$1282.23	\$1317.51	\$1374.67	\$1411.17	\$1491.47	\$1543.77	\$1690.99	\$1995.14	\$2196.83
-------	---------	-----------	-----------	-----------	-----------	-----------	-----------	-----------	-----------	-----------	-----------

**Cabriole Arm,
Upholstered Back**

8184-00

Dimensions

SH: 18 1/4"(464mm)
H: 32 5/8"(829mm)
D: 23 1/4"(591mm)
W: 22 3/4"(578mm)
AH: 26 1/2"(673mm)
SW: 19 1/2"(495mm)
SD: 18 1/4"(464mm)

Features

- Open arms.
- Upholstered seat and back.
- Maple hardwood frame. Seat frame rails are mortise and tenoned, cross locked with dowels.
- Seat is 1 3/4"(45mm) HR foam over a webbed panel.
- The upholstered back frame insert is webbed and padded with 1"(25mm) thick foam.
- COM yardage: 1.25
- COL square footage: 22.5

To Order, Specify:

- 1) Product number.
- 2) Fabric surface and color.
- 3) Wood finish color.

The following options require modification of the product number.

CAL 133
Stain Repellent
Moisture Barrier with Stain Repellent

To specify, add **-F** to end of the product number (add **\$109.49** list); **Example:** 8484-00-**F**
To specify, add **-P** to the end of the product number; **Example:** 8484-00-**P** (add **\$37.71** list)
To specify, add **-D** to the end of the product number; **Example:** 8484-00-**D** (add **\$49.87** list)

NOTE: Stain repellent and moisture barrier are not available on leather or faux leather.

For available fabrics, refer to surfaces.haworth.com.

Openest Collection

Plume Screens

Plume 3

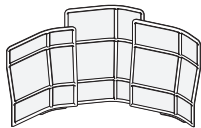

SON-3

Dimensions

H: 65"(1651mm)
 D: 34.5"(876mm)
 W: 125.75"(3194mm)
 (Outside)
 113.5"(2883mm)
 (Inside)

Features

- Includes:
 (1) 57"(1448mm)H x 50"(1270mm)W screen,
 (1) 65"(1651mm)H x 50"(1270mm)W screen,
 (1) 61"(1549mm)H x 50"(1270mm)W screen.
- All screens are connected together, not interchangeable.
- Available in King, Class and Maya fabrics only; COM not available.
- Floor support and screen connectors in same color.

To Order, Specify:

- 1) Product number.
- 2) Inner material.
- 3) Outer Material.
- 4) Trim color.

Number	Fabric Grade C	D
SON-3	\$8355.36	\$9640.80

Plume 6

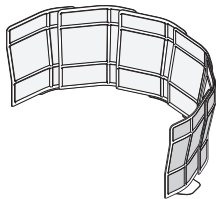

SON-6

Dimensions

H: 57"(1448mm)
 D: 84"(2134mm)
 W: 143.75"(3651mm)
 (Outside)
 132"(3353mm)
 (Inside)

Features

- Includes:
 (6) 57"(1448mm)H x 50"(1270mm)W screens.
- All screens are connected together, not interchangeable.
- Available in King, Class and Maya fabrics only; COM not available.
- Floor support and screen connectors in same color.

To Order, Specify:

- 1) Product number.
- 2) Inner material.
- 3) Outer Material.
- 4) Trim color.

SON-6	\$16068.00	\$18210.40
-------	------------	------------

Plume 9

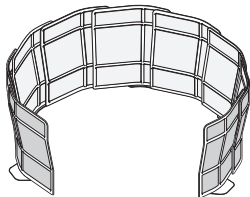

SON-9

Dimensions

H: 57"(1448mm)
 D: 128.5"(3264mm)
 W: 146.75"(3727mm)
 (Outside)
 131.25"(3334mm)
 (Inside)

Features

- Includes:
 (9) 57"(1448mm)H x 50"(1270mm)W screens.
- All screens are connected together, not interchangeable.
- Available in King, Class and Maya fabrics only; COM not available.
- Floor support and screen connectors in same color.

To Order, Specify:

- 1) Product number.
- 2) Inner material.
- 3) Outer Material.
- 4) Trim color.

SON-9	\$24102.00	\$26780.00
-------	------------	------------

Note: For mixed grade fabric surfaces, pricing will be determined by the sum of the upcharges. Please refer to the electronic design and specification tools for these prices.

Note: The Openest Plume screen is made with polyester fabric adhered to a polyester core. The screen is compliant with UL-1286 flammability requirements and California Technical Bulletin TB-117-2013 requirements. The fabric covering is compliant with NFPA 701 requirements. Consult your local code authority to assure that screens are compliant prior to installation.

Note: For additional Openest products, details and specifications please refer to the Openest Price List.

Openest Collection

Feather Sofa

Feather – Symmetrical

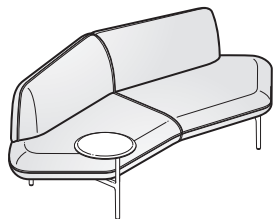

SOSS-1-RW

Dimensions

Sofa

SH: 16.5"(419mm)
 TH: 30.25"(768mm)
 SD: 25"(635mm)
 TD: 37"(940mm)
 W: 87"(2210mm)

Table

H: 19.5"(495mm)
 D: 15.75"(400mm)

Features

- Includes: Sofa with specifiable top-stitch thread and optional side mount table.
- Legs: Painted cast aluminum.
- Optional table:
 - Can be right-side or left-side mounted.
 - Rotates 360°
 - Available in Black, Polar, Stormy or Vapor painted MDF or planked wood in White Oak or Walnut.
 - Planked wood tops are designed to be unique, using solid wood planks with a clear, low-gloss finish showing natural variation.
- COM yardage: 6.5

Specification Tips

- Fabric will be applied railroaded.
- Linear or patterned fabric is not recommended due to the manner in which fabric is applied.

To Order, Specify:

1) Product number, including:

1 Surface Material:

- 1 Leather
- 2 Fabric
- 3 Faux Leather

2 Table Option:

- N No Table
- R Right Hand Table
- L Left Hand Table

- 2) Surface color.
- 3) Thread color.
- 4) Leg color.
- 5) Table finish (if applicable).

Description	Number 1 2	Fabric Grade								Leather Grade A	Leather Grade B
		A	B	C	D	E	F	G	H		
Without Table	SOSS- -N	\$3213.60	\$3395.70	\$3599.23	\$3749.20	\$4070.56	\$4231.24	\$4579.38	\$4686.50	\$6346.86	\$7632.30
With Painted MDF Table	SOSS- - P	3845.61	4027.71	4231.24	4381.21	4702.57	4863.25	5211.39	5318.51	6978.87	8264.31
With Wood Table - White Oak	SOSS- - W	4445.48	4627.58	4831.11	4981.08	5302.44	5463.12	5811.26	5918.38	7578.74	8864.18
With Wood Table - Walnut	SOSS- - W	4525.82	4707.92	4911.45	5061.42	5382.78	5543.46	5891.60	5998.72	7659.08	8944.52

The following options require modification of the product number.

Stain Repellent

To specify, add **-P** to the end of the product number; **Example:** SOSS-2-NP (add \$159.91 list)

Feather – Asymmetrical

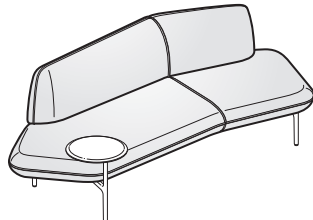

SOSR-1-RW

Dimensions

Sofa

SH: 16.5"(419mm)
 TH: 30.25"(768mm)
 SD: 25"(635mm)
 TD: 37"(940mm)
 W: 92"(2337mm)

Table

H: 19.5"(495mm)
 D: 15.75"(400mm)

Features

- Includes: Sofa with specifiable top-stitch thread and optional side mount table.
- Legs: Painted cast aluminum.
- Optional table:
 - Can be right-side or left-side mounted.
 - Rotates 360°
 - Available in Black, Polar, Stormy or Vapor painted MDF or planked wood in White Oak or Walnut.
 - Planked wood tops are designed to be unique, using solid wood planks with a clear, low-gloss finish showing natural variation.
- COM yardage: 6.75

Specification Tips

- Fabric will be applied railroaded.
- Linear or patterned fabric is not recommended due to the manner in which fabric is applied.
- Handedness determined when seated on sofa.

To Order, Specify:

1) Product number, including:

1 Handedness:

- R Right hand
- L Left hand

2 Surface Material:

- 1 Leather
- 2 Fabric
- 3 Faux Leather

3 Table Option:

- N No Table
- R Right Hand Table
- L Left Hand Table

- 2) Surface color.
- 3) Thread color.
- 4) Leg color.
- 5) Table finish (if applicable).

Description	Number 1 2 3	Fabric Grade								Leather Grade A	Leather Grade B
		A	B	C	D	E	F	G	H		
Without Table	SOS - -N	\$3267.16	\$3459.98	\$3668.86	\$3883.10	\$4204.46	\$4391.92	\$4766.84	\$4847.18	\$6395.06	\$7712.64
With Painted MDF Table	SOS - - P	3899.17	4091.99	4300.87	4515.11	4836.47	5023.93	5398.85	5479.19	7027.07	8344.65
With Wood Table - White Oak	SOS - - W	4499.04	4691.86	4900.74	5114.98	5436.34	5623.80	5998.72	6079.06	7626.94	8944.52
With Wood Table - Walnut	SOS - - W	4579.38	4772.20	4981.08	5195.32	5516.68	5704.14	6079.06	6159.40	7707.28	9024.86

The following options require modification of the product number.

Stain Repellent

To specify, add **P** to the end of the product number; **Example:** SOSS-2-NP (add \$159.91 list)

Note: For additional Openest products, details and specifications please refer to the Openest Price List.

Openest Collection

Chick Pouf

Chick Pouf with Back

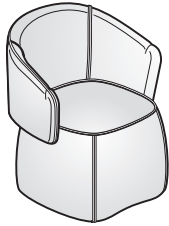

SOPB-22

Dimensions

SH: 18"(457mm)
 TH: 37.75"(959mm)
 SD: 18.75"(476mm)
 TD: 25.2"(640mm)
 W: 26"(660mm)

Features

- Includes: Seat and back with specifiable top-stitch thread and puck colors.
- Seat back flips up and down.
- Pull tab to flip back up or down available in orange only.
- COM yardage:
 Inner/Outer surfaces matching: 3.5
 Inner Back and Seat only: 1.5
 Outer Back and Base only: 2.0

Specification Tip

- Linear or patterned fabric is not recommended due to the manner in which fabric is applied.

To Order, Specify:

1) Product number, including:

1 Inner Surface Material:

- 1 Leather
- 2 Fabric
- 3 Faux Leather

2 Outer Surface Material:

- 1 Leather
- 2 Fabric
- 3 Faux Leather

- 2) Inner Surface Color (Seat, inside back).
- 3) Outer Surface Color (Base, outer back).
- 4) Thread color.
- 5) Puck color.

Number 1 2	Fabric Grade		C	D	E	F	G	H	Leather Grade A	Leather Grade B
	A	B								
SOPB-■ ■	\$1874.59	\$1981.71	\$2126.33	\$2260.23	\$2474.47	\$2586.95	\$2838.67	\$2919.01	\$3534.97	\$4204.47

Chick Pouf without Back

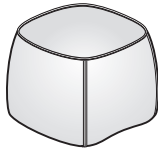

SOPN-22

Dimensions

H: 18"(457mm)
 D: 22.5"(572mm)
 W: 23.25"(591mm)

Features

- Includes: Seat/Base only with specifiable top-stitch thread color.
- COM yardage:
 Seat and Base matching: 2.0
 Seat only: .75
 Base only: 2.0

Specification Tip

- Linear or patterned fabric is not recommended due to the manner in which fabric is applied.

To Order, Specify:

1) Product number, including:

1 Inner Surface Material:

- 1 Leather
- 2 Fabric
- 3 Faux Leather

2 Outer Surface Material:

- 1 Leather
- 2 Fabric
- 3 Faux Leather

- 2) Inner Surface Color (Seat).
- 3) Outer Surface Color (Base).
- 4) Thread color.

Number 1 2	Fabric Grade		C	D	E	F	G	H	Leather Grade A	Leather Grade B
	A	B								
SOPN-■ ■	\$905.16	\$964.08	\$1055.13	\$1151.54	\$1280.08	\$1353.99	\$1526.46	\$1569.30	\$2088.11	\$2595.86

The following options require modification of the product number.

Stain Repellent

To specify, add **-P** to the end of the product number; **Example:** SOPB-22-P; SOPN-22-P (add **\$80.50** list for Chick Pouf with Back or **\$46.00** for Chick Pouf without Back)

Note: Upcharge for mixed grade surfaces, refer to the electronic design and specification tools.

Note: For additional Openest products, details and specifications please refer to the Openest Price List.

Openest Collection

Sprig Tables

Rectangle

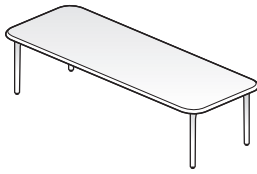

SORA-5320-P

Features

- Includes: Table top and legs.
- Top available in Black, Polar, Stormy or Vapor painted MDF or planked wood in White Oak or Walnut.
- Planked wood tops are designed to be unique, using solid wood planks with a clear, low-gloss finish showing natural variation.
- Legs: Painted cast aluminum.

To Order, Specify:

1) Product number, including:

① Surface Material:

- P** Painted MDF
- W** Planked Wood

2) Top color.

3) Leg color.

Height	Depth	Width	Number ①	Painted	White Oak	Walnut
12"(305mm)	20"(508mm)	53"(1346mm)	SORA-5320-■	\$889.10	\$2222.74	\$2704.78

Round



SODC-1616-P



SODB-2424-P

Features

- Includes: Table top and legs.
- Top available in Black, Polar, Stormy, or Vapor painted MDF or planked wood in White Oak or Walnut.
- Planked wood tops are designed to be unique, using solid wood planks with a clear, low-gloss finish showing natural variation.
- Legs: Painted cast aluminum.

To Order, Specify:

1) Product number, including:

① Surface Material:

- P** Painted MDF
- W** Planked Wood

2) Top color.

3) Leg color.

Height	Diameter	Number ①	Painted	White Oak	Walnut
17"(432mm)	16"(406mm)	SODC-1616-■	\$632.01	\$1285.44	\$1392.56
14"(356mm)	24"(610mm)	SODB-2424-■	696.28	1724.63	1981.72

Note: For additional Openest products, details and specifications please refer to the Openest Price List.

This page intentionally blank

Poppy-At-A-Glance

Designer	Patricia Urquiola
Fabric	Linear or patterned fabric not recommended due to the manner in which the material is applied. Because of the nature of the chair, materials that have more fibers or woolen spun yarn construction, such as Cotswold, King, Class and Maya, tend to upholster well on Poppy. Synthetic fibers, or textiles with heavy back coatings, tend to be more difficult to upholster and consequently may restrict some COMs.

Guest Seating

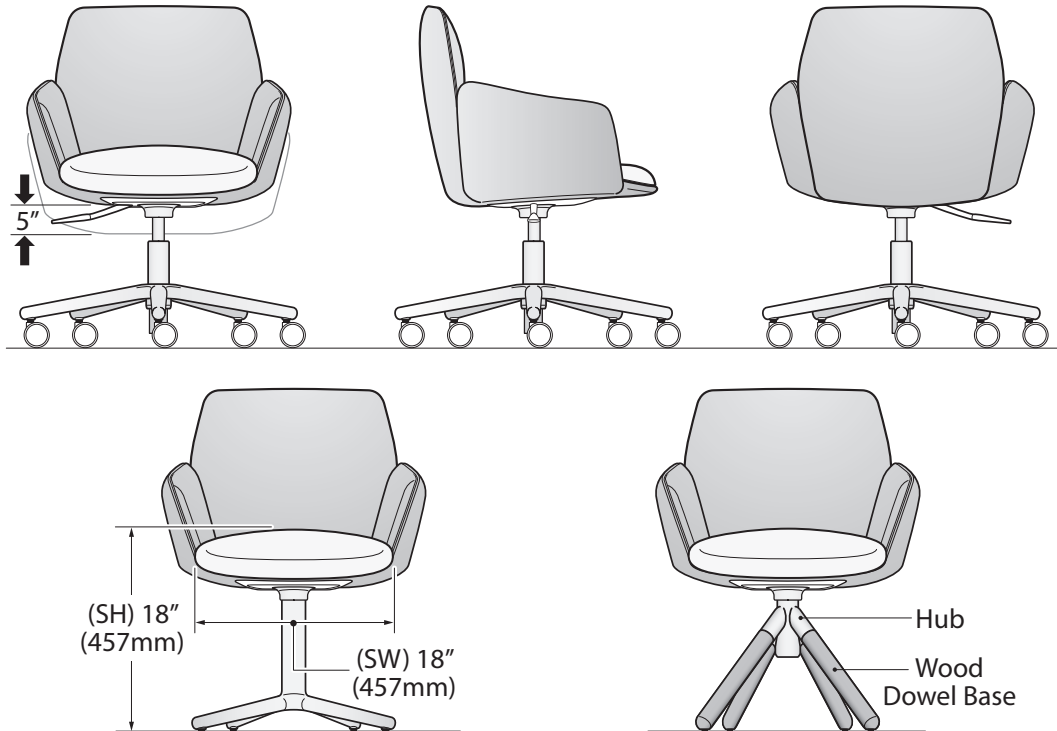

Lounge Seating

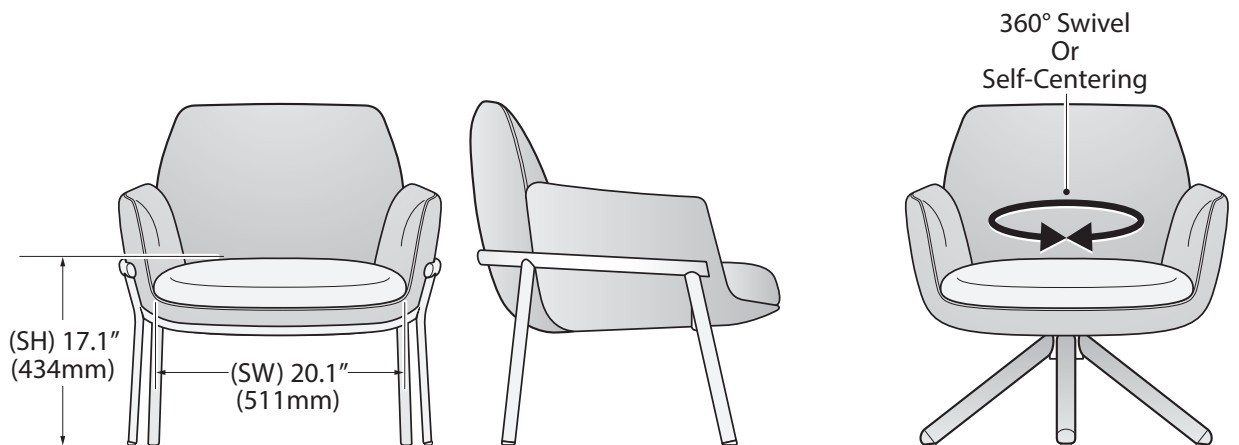

Poppy

Guest

Four Star Base with Glides



SPG-11-4

Dimensions

SH: 18"(457mm)
 H: 33"(838mm)
 D: 26.75"(679mm)
 W: 26.75"(679mm)
 SW: 18"(457mm)
 SD: 18"(457mm)
 AH: 25"(635mm)

Features

- Back and arms: Upholstered in matching upholstery.
- Seat: Standard upholstered. Upholstery can match or complement back and arms.
- Base: Four star aluminum base.
 –Standard with glides; felt pads included
 –Available in Black (TR-F) or Smooth Plaster (TR-PLS)
- Seat swivels 360°.
- COM yardage / COL square footage: 2.0/55
 Back/Arms: 1.5/40
 Seat: 0.5/15

Specification Tip

- Linear or patterned fabric is not recommended due to the manner in which fabric is applied.

To Order, Specify:

- 1) Product number, including;

1 Seat Upholstery:

- 1 Leather
- 2 Fabric
- 3 Faux Leather

2 Back/Arm Upholstery:

- 1 Leather
- 2 Fabric
- 3 Faux Leather

- 2) Seat surface and color.
- 3) Back/arm surface and color.
- 4) Trim color.
 TR-F Black
 TR-PLS Smooth Plaster, add **\$55.65** list.

Number ① ②	Fabric Grade		C	D	E	F	G	H	Leather Grade A	Leather Grade B
	A	B								
SPG-■ ■ -4	\$1606.80	\$1678.90	\$1740.70	\$1828.25	\$1931.25	\$1982.75	\$2008.50	\$2060.00	\$2023.95	\$2137.25

Five Star Base with Casters



SPG-11-5

Dimensions

SH: 16"-21"
 (406mm-533mm)
 H: 31"-36"
 (787mm-914mm)
 D: 26.75"(679mm)
 W: 26.75"(679mm)
 SW: 18"(457mm)
 SD: 18"(457mm)
 AH: 23"-28"
 (584mm-711mm)

Features

- Back and arms: Upholstered in matching upholstery.
- Seat: Standard upholstered. Upholstery can match or complement back and arms.
- Base: Five star aluminum base.
 –Available in Black (TR-F) or Smooth Plaster (TR-PLS)
 –Casters match base color; Smooth Plaster casters are two-tone with graphite tread.
- Soft casters available in black only, add **\$25.75** list.
- Seat swivels 360°.
- Pneumatic height adjustment of 5"(127mm).
- COM yardage / COL square footage: 2.0/55
 Back/Arms: 1.5/40
 Seat: 0.5/15

Specification Tip

- Linear or patterned fabric is not recommended due to the manner in which fabric is applied.

To Order, Specify:

- 1) Product number, including;

1 Seat Upholstery:

- 1 Leather
- 2 Fabric
- 3 Faux Leather

2 Back/Arm Upholstery:

- 1 Leather
- 2 Fabric
- 3 Faux Leather

- 2) Seat surface and color.
- 3) Back/arm surface and color.
- 4) Trim color.
 TR-F Black
 TR-PLS Smooth Plaster, add **\$55.00** list.

Number ① ②	Fabric Grade		C	D	E	F	G	H	Leather Grade A	Leather Grade B
	A	B								
SPG-■ ■ -5	\$1699.50	\$1771.60	\$1833.40	\$1920.95	\$2023.95	\$2075.45	\$2101.20	\$2152.70	\$2116.65	\$2229.95

The following options require modification of the product number.

Soft Casters
 Stain Repellent

Change the 6th digit in the product number to **6**, and add **\$25.75** list. **Example:** SPG-22-**6**
 To specify, add **P** to the end of the product number; **Example:** SPG-22-**5P** (add **\$60.77** list)

Poppy

Guest

Wood Base



SPG-11-W

Dimensions

SH: 18"(457mm)
 H: 33"(838mm)
 D: 24.25"(616mm)
 W: 24.25"(616mm)
 SW: 18"(457mm)
 SD: 18"(457mm)
 AH: 25"(635mm)

Features

- Back and arms: Upholstered in matching upholstery.
- Seat: Standard upholstered. Upholstery can match or complement back and arms.
- Base: Wooden dowel legs with painted aluminum hub.
 - Wooden legs available in Clear on Oak (M5-W35), Clear on Walnut (M6-W35) and Ink on Ash (M7-W43)
 - Wooden legs standard with glides; felt pads included
 - Hub available in Black (TR-F) or Smooth Plaster (TR-PLS)
- Seat swivels 360°.
- COM yardage / COL square footage: 2.0/55
 - Back/Arms: 1.5/40
 - Seat: 0.5/15

Specification Tip

- Linear or patterned fabric is not recommended due to the manner in which fabric is applied.

To Order, Specify:

- 1) Product number, including;

1 Seat Upholstery:

- 1 Leather
- 2 Fabric
- 3 Faux Leather

2 Back/Arm Upholstery:

- 1 Leather
- 2 Fabric
- 3 Faux Leather

- 2) Seat surface and color.
- 3) Back/arm surface and color.
- 4) Trim color.
 - TR-F Black
 - TR-PLS Smooth Plaster, add **\$41.20** list.
- 5) Wood finish.

Description	Number ① ②	A	B	C	D	E	F	G	H	Leather Grade A	Leather Grade B
Ink on Ash	SPG-■ ■ -W	\$2085.75	\$2157.85	\$2219.65	\$2307.20	\$2410.20	\$2461.70	\$2487.45	\$2538.95	\$2502.90	\$2616.20
Clear on Oak	SPG-■ ■ -W	2116.65	2188.75	2250.55	2338.10	2441.10	2492.60	2518.35	2569.85	2533.80	2647.10
Clear on Walnut	SPG-■ ■ -W	2126.95	2199.05	2260.85	2348.40	2451.40	2502.90	2528.65	2580.15	2544.10	2657.40

The following options require modification of the product number.

Stain Repellent

To specify, add **P** to the end of the product number; **Example:** SPG-22-WP (add **\$60.77** list)

Poppy

Lounge

Basket



SLP-22-T

Dimensions

SH: 17.1"(434mm)
 H: 32.6"(828mm)
 D: 29.4"(747mm)
 W: 31"(787mm)
 SW: 20.1"(511mm)
 SD: 20.5"(521mm)
 AH: 24"(610mm)

Features

- Back and arms: Upholstered in matching upholstery.
- Seat: Upholstery can match or complement back and arms.
- Base: Four leg painted steel basket frame.
 –Available in Black (TR-F), Smooth Plaster (TR-PLS), Sable (TR-1M) or Rusty Red (TR-RR).
- Glides: Available in felt or hard plastic.
- COM yardage / COL square footage: 4.0/72
 Back/Arms: 3.0/54
 Seat: 1.0/18

Specification Tip

- Linear or patterned fabric is not recommended due to the manner in which fabric is applied.

To Order, Specify:

1) Product number, including;

1 Seat Upholstery:

- 1 Leather
- 2 Fabric
- 3 Faux Leather

2 Back/Arm Upholstery:

- 1 Leather
- 2 Fabric
- 3 Faux Leather

3 Glide Style:

- F Felt
- H Hard

2) Seat surface and color.

3) Back/arm surface and color.

4) Trim color.

- TR-F Black
- TR-1M Sable
- TR-RR Rusty Red
- TR-PLS Smooth Plaster, add **\$55.00** list

Number 1 2 3	Fabric Grade			D	E	F	G	H	Leather Grade A	Leather Grade B
	A	B	C							
SLP- <input type="checkbox"/> <input type="checkbox"/> -T <input type="checkbox"/>	\$2195.00	\$2320.00	\$2435.00	\$2600.00	\$2745.00	\$3300.00	\$3630.00	\$4230.00	\$4575.00	\$5580.00

Swivel



SLP-22-S
SLP-22-R

Dimensions

SH: 17.1"(434mm)
 H: 32.6"(828mm)
 D: 29.4"(747mm)
 W: 31"(787mm)
 SW: 20.1"(511mm)
 SD: 20.5"(521mm)
 AH: 24"(610mm)

Features

- Back and arms: Upholstered in matching upholstery.
- Seat: Upholstery can match or complement back and arms.
- Base: Four wooden dowel legs.
 –Legs available in Clear on Oak (M5-W35), Clear on Walnut (M6-W35) and Ink on Ash (M7-W43).
- Available with 360° or self-centering swivel base.
- Glides: Available in felt or hard plastic.
- COM yardage / COL square footage: 4.0/72
 Back/Arms: 3.0/54
 Seat: 1.0/18

Specification Tip

- Linear or patterned fabric is not recommended due to the manner in which fabric is applied.

To Order, Specify:

1 Seat Upholstery:

- 1 Leather
- 2 Fabric
- 3 Faux Leather

2 Back/Arm Upholstery:

- 1 Leather
- 2 Fabric
- 3 Faux Leather

3 Glide Style:

- F Felt
- H Hard

2) Seat surface and color.

3) Back/arm surface and color.

4) Wood finish

Description	Number 1 2 3	Fabric Grade			D	E	F	G	H	Leather Grade A	Leather Grade B
		A	B	C							
360° Swivel Base											
Ink on Ash	SLP- <input type="checkbox"/> <input type="checkbox"/> -S <input type="checkbox"/>	\$2655.00	\$2780.00	\$2895.00	\$3060.00	\$3205.00	\$3760.00	\$4090.00	\$4690.00	\$5035.00	\$6040.00
Clear on Oak	SLP- <input type="checkbox"/> <input type="checkbox"/> -S <input type="checkbox"/>	\$2685.00	\$2810.00	\$2925.00	\$3090.00	\$3235.00	\$3790.00	\$4120.00	\$4720.00	\$5065.00	\$6070.00
Clear on Walnut	SLP- <input type="checkbox"/> <input type="checkbox"/> -S <input type="checkbox"/>	\$2735.00	\$2860.00	\$2975.00	\$3140.00	\$3285.00	\$3840.00	\$4170.00	\$4770.00	\$5115.00	\$6120.00
Self-Centering Base											
Ink on Ash	SLP- <input type="checkbox"/> <input type="checkbox"/> -R <input type="checkbox"/>	\$2680.00	\$2805.00	\$2920.00	\$3085.00	\$3230.00	\$3785.00	\$4115.00	\$4715.00	\$5060.00	\$6065.00
Clear on Oak	SLP- <input type="checkbox"/> <input type="checkbox"/> -R <input type="checkbox"/>	\$2710.00	\$2835.00	\$2950.00	\$3115.00	\$3260.00	\$3815.00	\$4145.00	\$4745.00	\$5090.00	\$6095.00
Clear on Walnut	SLP- <input type="checkbox"/> <input type="checkbox"/> -R <input type="checkbox"/>	\$2760.00	\$2885.00	\$3000.00	\$3165.00	\$3310.00	\$3865.00	\$4195.00	\$4795.00	\$5140.00	\$6145.00

The following options require modification of the product number.

Stain repellent

To specify, add **P** to end of the product number (add **\$92.00** list); **Example:** SLP-22-TFP

NOTE: For mixed grade fabrics on seat and back please refer to the electronic design and specification tools for pricing.

Harbor Work Lounge At-A-Glance

Designer

Nicolai Czumaj-Bront of the Haworth Design Studio

Awards/Achievements

Best of Neocon 2013: Silver - Seating/Collaborative Work
 Good Design Award 2013 - Furniture

Inner Shell
 (Upholstered Only)

Outer Shell
 (Upholstered,
 Laminate, Wood Veneer)

Caster Options:

- Hard or Soft (Black)
- Hard (Fog & Gray)
- Glide

Fully Upholstered

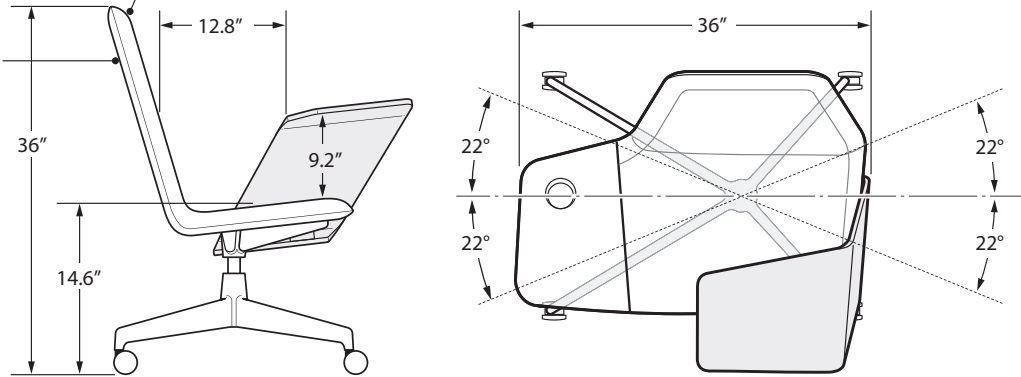

Cup Holder Fully Upholstered

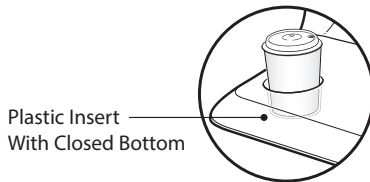

Cup Holder Partially Upholstered

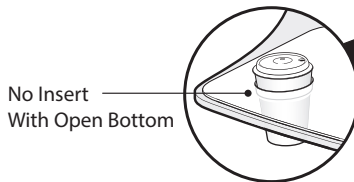

Partially Upholstered

Wing:
 Available as Left
 or Right handed.
 Noble Fabric Only

Tablet:
 Laminate or Wood

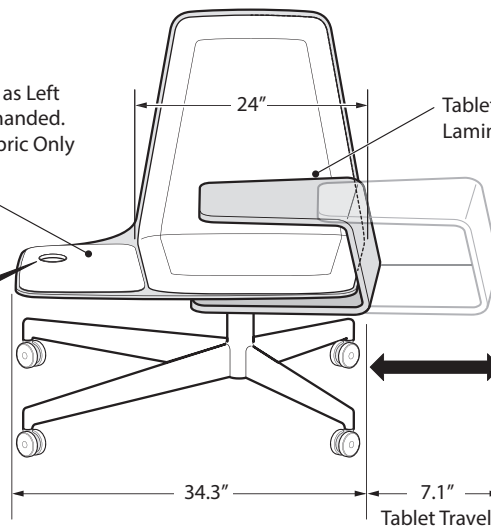

Harbor Work Lounge

Fully Upholstered, Cast Aluminum Base

Lounge Chair



SHL-22-1R10



SHL-22-1R12

Dimensions

SH: 14.6" (371mm)
 H: 36" (9147mm)
 W: 35.3" (897mm) w/o tablet
 36" (914mm) w/tablet
 SD: 16" (406mm)
 SW: 24" (610mm)

Features

- Includes: Upholstered outer and inner shell, right or left wing with cup holder, optional tablet arm and cast aluminum base.
- Fully upholstered lounge chair will be completely upholstered (No laminate or wood veneer visible). Upholstery must be the same material type for inner and outer shell.
- Outer Shell: Upholstered one-piece molded plywood shell.
- Inner Shell: Upholstered molded foam 1.25"(31.75mm) thick.
- Base: Cast-aluminum.
 - Standard painted in Black, Accent Orange, Smooth Plaster or with optional polished aluminum.
 - Swivels 22° in each direction and features a self-returning mechanism.
- Casters: Available with hard black, soft black or hard two-tone.
- Glides: Optional glides ship with plastic and felt tips.
- Seat Wing: Upholstered in Noble performance suede only. Handedness determined by seated position.
- Cup Holder: Available in Chalk or Black plastic.
- Tablet Arm: Optional tablet arm is a one-piece molded plywood form, available in laminate or wood veneer.
 - Laminate finishes include Linen, Putty or Charcoal.
 - Wood veneer finishes include Rift-Cut White Oak or Walnut.
 - Tablet slides 7.1"(180.3mm) to the side.
 - Available in right or left-hand configuration (opposite of seat wing specification).
- COM Yardage / COL square footage
 Inner/Outer Shell: 2.0/28

To Order, Specify:

1) Product number, including:

1 Base Option:

- 1** Hard Caster
- 2** Soft Caster
- T** Two-Tone
- G** Glides, add **\$155.32** list

2 Wing Option:

- R** Right Wing
- L** Left Wing

3 Tablet Option:

- 0** No Tablet
- 1** Wood Tablet, add **\$1478.26** list
- 2** Laminate Tablet, add **\$1478.26** list

2) Inner shell material.

3) Outer shell material.

4) Base color
 Polished aluminum, add **\$80.34** list.

5) Wing surface and color.

6) Cup holder color.

7) Tablet surface and color.

	Number	Fabric Grade									Leather Grade A	Leather Grade B		
		1	2	3	A	B	C	D	E	F			G	H
Leather	SHL-11-	■	■	1 ■	N/A	N/A	N/A	N/A	N/A	N/A	N/A	N/A	\$3331.43	\$3615.30
Fabric	SHL-22-	■	■	1 ■	\$2179.89	\$2252.73	\$2328.79	\$2406.98	\$2523.75	\$2645.86	\$2773.33	\$2908.31	N/A	N/A
Faux Leather	SHL-33-	■	■	1 ■	\$2179.89	\$2252.73	\$2328.79	\$2406.98	\$2523.75	\$2645.86	\$2773.33	\$2908.31	N/A	N/A

The following options require modification of the product number.

CAL 133

To specify, add **F** to the end of the product number; **Example:** SHL-22-1R10F (add **\$364.21** list)

NOTE: For available fabrics please refer to surfaces.haworth.com.

Harbor Work Lounge

Fully Upholstered, Cast Aluminum Base

Ottoman



SHO-22-G

Dimensions

H: 16.5"-19.5"
(419mm-495mm)
D: 17.9" (455mm)
W: 24.9" (632mm)

Features

- Includes: Fully upholstered surface, cup holder and cast aluminum base.
- Fully upholstered ottoman will be completely upholstered (no laminate or wood veneer visible).
- Surface: Upholstered one-piece molded plywood.
- Cushion: Upholstered molded foam 1.25"(31.75mm) thick.
- Cast Aluminum Base: Features 3.0"(76.2mm) height adjustment.
-Standard painted in Black, Accent Orange, Smooth Plaster or with optional polished aluminum.
- Cup holder: Swing out open hole cup holder standard in polished aluminum.
- Casters: Available with hard black, soft black or hard two-tone.
- Glides: Optional glides ship with plastic and felt tips.
- COM Yardage / COL square footage: 1.0/12

To Order, Specify:

- 1) Product number, including:
 - 1** Base Option:
 - 1** Hard Caster
 - 2** Soft Caster
 - T** Two-Tone
 - G** Glides, add **\$155.32** list
- 2) Surface material.
- 3) Base color
Polished aluminum, add **\$80.34** list.

	Number 1	Fabric Grade								Leather Grade A	Leather Grade B
		A	B	C	D	E	F	G	H		
Leather	SHO-11-■	N/A	N/A	N/A	N/A	N/A	N/A	N/A	N/A	\$2208.81	\$2393.06
Fabric	SHO-22-■	\$1456.83	\$1505.03	\$1554.31	\$1605.73	\$1681.78	\$1761.05	\$1844.60	\$1932.44	N/A	N/A
Faux Leather	SHO-33-■	\$1456.83	\$1505.03	\$1554.31	\$1605.73	\$1681.78	\$1761.05	\$1844.60	\$1932.44	N/A	N/A

The following options require modification of the product number.

CAL 133

To specify, add **F** to the end of the product number; **Example:** SHO-22-1F (add **\$139.26** list)

NOTE: For available fabrics please refer to surfaces.haworth.com.

Harbor Work Lounge

Partially Upholstered, Cast Aluminum Base

Lounge Chair



SHL-25-1L10



SHL-25-1L12

Dimensions

SH: 14.4" (366mm)
 H: 35.5" (902mm)
 W: 34.3" (8714mm) w/o tablet
 35.5" (902mm) w/tablet
 SD: 16" (406mm)
 SW: 24" (610mm)

Features

- Includes: Laminate or wood veneer outer shell, fabric inner shell, right or left wing with cup holder, optional tablet arm and cast aluminum base.
- Outer Shell: One-piece molded plywood shell with exposed laminate or wood veneer.
- Inner Shell: Upholstered molded foam 1" (25.4 mm) thick with exposed laminate or wood veneer perimeter.
- Base: Cast-aluminum.
 - Standard painted in Black, Accent Orange, Smooth Plaster or with optional polished aluminum.
 - Swivels 22° in each direction and features a self-returning mechanism.
- Casters: Available with hard black, soft black or hard two-tone.
- Glides: Optional glides ship with plastic and felt tips.
- Seat Wing: Upholstered in Noble performance suede only. Handedness determined by seated position.
- Cup Holder: Open hole - no finish options.
- Tablet Arm: Optional tablet arm is a one-piece molded plywood form, available in laminate or wood veneer.
 - Laminate finishes include Linen, Putty or Charcoal.
 - Wood veneer finishes include Rift-Cut White Oak or Walnut.
 - Tablet slides 7.1" (180.3mm) to the side.
 - Available in right or left-hand configuration (opposite of seat wing specification).
- COM Yardage / COL square footage
 Inner Shell: 1.25/22

To Order, Specify:

1) Product number, including:

1 Base Option:

- 1** Hard Caster
- 2** Soft Caster
- T** Two-Tone
- G** Glides, add **\$155.32** list

2 Wing Option:

- R** Right Wing
- L** Left Wing

3 Tablet Option:

- 0** No Tablet
- 1** Wood Tablet, add **\$1478.26** list
- 2** Laminate Tablet, add **\$1478.26** list

- 2) Inner shell material.
- 3) Outer shell material.
- 4) Base color
Polished aluminum, add **\$80.34** list.
- 5) Wing surface and color.
- 6) Tablet surface and color.

	Number	Laminate Grade A Fabric Grade								Leather Grade A	Leather Grade B			
		1	2	3	A	B	C	D	E			F	G	H
Leather	SHL-15-	■	■	1 ■	N/A	N/A	N/A	N/A	N/A	N/A	N/A	N/A	\$4024.50	\$4308.37
Fabric	SHL-25-	■	■	1 ■	\$2872.96	\$2945.80	\$3021.86	\$3100.05	\$3216.82	\$3338.93	\$3466.40	\$3601.38	N/A	N/A
Faux Leather	SHL-35-	■	■	1 ■	\$2872.96	\$2945.80	\$3021.86	\$3100.05	\$3216.82	\$3338.93	\$3466.40	\$3601.38	N/A	N/A

	Number	Wood Fabric Grade								Leather Grade A	Leather Grade B			
		1	2	3	A	B	C	D	E			F	G	H
Leather	SHL-14-	■	■	1 ■	N/A	N/A	N/A	N/A	N/A	N/A	N/A	N/A	\$4069.49	\$4353.36
Fabric	SHL-24-	■	■	1 ■	\$2917.95	\$2990.79	\$3066.85	\$3145.04	\$3261.81	\$3383.92	\$3511.39	\$3646.37	N/A	N/A
Faux Leather	SHL-34-	■	■	1 ■	\$2917.95	\$2990.79	\$3066.85	\$3145.04	\$3261.81	\$3383.92	\$3511.39	\$3646.37	N/A	N/A

The following options require modification of the product number.

CAL 133

To specify, add **F** to the end of the product number; **Example:** SHL-25-1R10F (add **\$214.24** list)

NOTE: For available fabrics please refer to surfaces.haworth.com.

Harbor Work Lounge

Partially Upholstered, Cast Aluminum Base

Ottoman



SHO-25-G

Dimensions

H: 16.25"-19.25"
(413mm-489mm)
D: 17.9" (455mm)
W: 24.9" (632mm)

Features

- Includes: Laminate or wood veneer surface, fabric cushion, cup holder and cast aluminum base.
- Upholstered one-piece molded plywood.
- Cushion: Upholstered molded foam 1"(25.4mm) thick with exposed laminate or wood veneer perimeter.
- Cast Aluminum Base: Features 3.0"(76.2mm) height adjustment.
 - Standard painted in Black, Accent Orange, Smooth Plaster or with optional polished aluminum.
- Cup holder: Swing out open hole cup holder standard in polished aluminum.
- Casters: Available with hard black, soft black or hard two-tone.
- Glides: Optional glides ship with plastic and felt tips.
- COM Yardage / COL square footage: 1.0/10

To Order, Specify:

1) Product number, including:

1 Base Option:

- 1** Hard Caster
- 2** Soft Caster
- T** Two-Tone
- G** Glides, add **\$155.32** list

2) Inner surface material.

3) Outer surface material.

4) Base color
Polished aluminum, add **\$80.34** list.

	Number ①	Laminate Grade A Fabric Grade								Leather Grade A	Leather Grade B
		A	B	C	D	E	F	G	H		
Leather	SHO-15-■	N/A	N/A	N/A	N/A	N/A	N/A	N/A	N/A	\$2381.27	\$2565.52
Fabric	SHO-25-■	\$1629.29	\$1677.49	\$1726.77	\$1778.19	\$1854.24	\$1933.51	\$2017.06	\$2104.90	N/A	N/A
Faux Leather	SHO-35-■	\$1629.29	\$1677.49	\$1726.77	\$1778.19	\$1854.24	\$1933.51	\$2017.06	\$2104.90	N/A	N/A

	Number ①	Wood Fabric Grade								Leather Grade A	Leather Grade B
		A	B	C	D	E	F	G	H		
Leather	SHO-14-■	N/A	N/A	N/A	N/A	N/A	N/A	N/A	N/A	\$2406.98	\$2591.23
Fabric	SHO-24-■	\$1655.00	\$1703.20	\$1752.48	\$1803.90	\$1879.95	\$1959.22	\$2042.77	\$2130.61	N/A	N/A
Faux Leather	SHO-34-■	\$1655.00	\$1703.20	\$1752.48	\$1803.90	\$1879.95	\$1959.22	\$2042.77	\$2130.61	N/A	N/A

The following options require modification of the product number.

CAL 133

To specify, add **F** to the end of the product number; **Example:** SHO-25-1F (add **\$139.26** list)

NOTE: For available fabrics please refer to surfaces.haworth.com.

Hello Seating

Lounge with Legs

Standard Arm

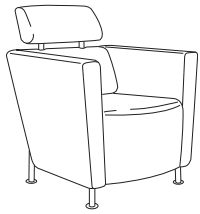

4854-0011

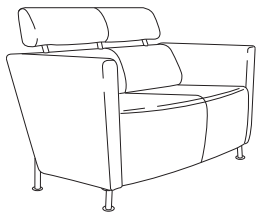

4854-0012

Dimensions

Lounge Chair

SH: 17 1/2"(445mm)
 H: 35"(889mm)
 D: 30 1/4"(768mm)
 W: 30 1/2"(775mm)
 AH: 9 1/2"(241mm)
 SW: 21 1/4"(540mm)
 SD: 20 1/4"(514mm)

Settee

SH: 17 1/2"(445mm)
 H: 35"(889mm)
 D: 30 1/4"(768mm)
 W: 56 1/2"(1435mm)
 AH: 9 1/2"(241mm)
 SW: 46 3/4"(1187mm)
 SD: 20 1/4"(514mm)

Features

- Available as single cushion lounge chair or double cushion settee.
- Upholstered back/seat.
- Passive lumbar back support.
- Interior frame has glued and doweled joints, reinforced with screws and cleats.
- Exposed metal legs.
- Optional two fabrics/one fabric two colors available on seat and back.
- Optional grommets available in both arms to accommodate accessories.
- Optional accessories include cup holder and tablet arm.
- Legs, back support uprights and optional grommets are available in TR-LE Metallic Silver only.
- Settee in leather requires a vertical seam.
- COM yardage / COL square footage:
 One Seat Lounge: 4.25/76.5
 Seat: 1.0/18.0
 Back and Arms: 3.25/58.7
 Two Seat Lounge: 7.0/126.0
 Seat: 1.75/31.5
 Back and Arms: 5.25/94.5

To Order, Specify:

- 1) Product number.
- 2) Fabric surface and color.
 or 2a. Fabric surface and color for seat.
 2b. Fabric surface and color for back and arms
- 3) Trim color for legs, back support uprights (grommets)
(Available in TR-LE Metallic Silver Only)

Description	Number	Fabric Grade								Leather Grade A	Leather Grade B
		A	B	C	D	E	F	G	H		
Lounge chair w/o grommets	4854-0011	\$1936.73	\$2102.18	\$2243.30	\$2557.17	\$2647.19	\$2777.35	\$2957.41	\$3454.97	\$5175.16	\$ 6960.46
Lounge chair with grommets	4854-0011-G	2027.98	2193.43	2334.55	2648.42	2738.44	2868.60	3048.66	3546.22	5266.41	7051.71
Lounge chair with two fabrics/colors	4854-0011-T	1936.73	2267.63	2549.87	3177.61	3357.65	3617.97	3978.09	4973.21	8413.59	11984.19
Lounge chair with grommets/ two fabrics/two colors of same fabric	4854-0011-GT	2027.98	2358.88	2641.12	3268.86	3448.90	3709.22	4069.34	5064.46	8504.84	12075.44
Settee w/o grommets	4854-0012	\$2765.20	\$2930.65	\$3071.77	\$3385.64	\$3475.66	\$4150.84	\$4448.89	\$5266.41	\$6003.63	\$ 7788.93
Settee with grommets	4854-0012-G	2856.45	3021.90	3163.02	3476.89	3566.91	4242.09	4540.14	5357.66	6094.88	7880.18
Settee with two fabrics/colors	4854-0012-T	2765.20	3096.10	3378.34	4006.08	4186.12	5536.48	6132.58	7767.62	9242.06	12812.66
Settee with grommets/ two fabrics/ two colors of same fabrics	4854-0012-GT	2856.45	3187.35	3469.59	4097.33	4277.37	5627.73	6223.83	7858.87	9333.31	12903.91

The following options require modification of the product number.

Stain Repellent	To specify, add -P to the end of the product number; Example: 4854-0011- P (add \$63.25 list)
Moisture Barrier with Stain Repellent	To specify, add -D to the end of the product number; Example: 4854-0011- D (add \$99.75 list)
Leather Upholstery	To specify, change the 2nd digit in the product number from an 8 to a 7 and specify the leather surface and color; Example: 4754-0011

NOTE: Stain repellent and moisture barrier are not available on leather or faux leather.

For available fabrics, refer to surfaces.haworth.com.

Hello Seating

Mobile Lounge

Standard Arm

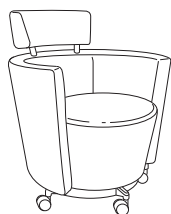

4855-0043

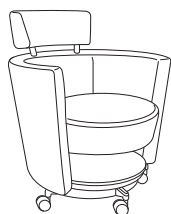

4855-0043-S



4855-0043-GSX

Dimensions

SH: 17 1/4"(438mm)
 H: 34 3/4"(883mm)
 D: 26"(660mm)
 W: 30 3/4"(781mm)
 AH: 9 1/2"(241mm)
 SW: 18 3/4"(476mm)
 SD: 19 1/2"(495mm)

Features

- Upholstered back/seat.
- 360° swivel base standard.
- Passive lumbar back support.
- Casters: Standard with two-tone hard casters.
- Optional two-tone soft casters.
- Optional two fabrics/two colors of same fabric available on seat and back.
- Optional grommets to accommodate cup holder or tablet arm.
- Optional shelf model available with lower molded plywood storage shelf.
- Optional fully-loaded mobile lounge includes accessories as listed below.
- Optional accessories include cup holder and tablet arm.
- Swivel base, back support uprights and optional grommets are available in TR-LE Metallic Silver only.
- COM yardage / COL square footage:
 Lounge: 4.0/72.0
 Seat: 1.0/18.0
 Back and Arms: 3.75/67.5

 Lounge w/Shelf: 4.0/72.0
 Seat: 1.0/18.0
 Back and Arms: 3.75/67.5

To Order, Specify:

- 1) Product number.
- 2) Fabric surface and color.
 or 2a. Fabric surface and color for seat.
 2b. Fabric surface and color for back and arms.
- 3) Trim color for base (grommets, cup holder).
(Available in TR-LE Metallic Silver Only)
- 4) Wood finish color for shelf (tablet arm/cup holder).

Description	Number	Fabric Grade								Leather Grade A	Leather Grade B
		A	B	C	D	E	F	G	H		
Upholstered/One Fabric and Color											
Upholstered	4855-0043	\$1908.75	\$2038.91	\$2152.07	\$2172.74	\$2193.42	\$2699.50	\$2868.60	\$3338.18	\$2725.05	\$3173.95
Upholstered/grommet	4855-0043-G	2000.00	2130.16	2243.32	2263.99	2284.67	2790.75	2959.85	3429.43	2816.30	3265.20
Upholstered/shelf	4855-0043-S	2133.81	2263.97	2377.13	2397.80	2418.48	2924.56	3093.66	3563.24	2950.11	3399.01
Upholstered/grommet/shelf	4855-0043-GS	2225.06	2355.22	2468.38	2489.05	2509.73	3015.81	3184.91	3654.49	3041.36	3490.26
Upholstered/Two Fabrics or One Fabric, Two Colors											
Upholstered	4855-0043-T	\$1908.75	\$2169.07	\$2395.39	\$2436.73	\$2478.09	\$3490.25	\$3828.45	\$4767.61	\$3541.35	\$4439.15
Upholstered/grommet	4855-0043-GT	2000.00	2260.32	2486.64	2527.98	2569.34	3581.50	3919.70	4858.86	3632.60	4530.40
Upholstered/shelf	4855-0043-ST	2133.81	2394.13	2620.45	2661.79	2703.15	3715.31	4053.51	4992.67	3766.41	4664.21
Upholstered/grommet/shelf	4855-0043-GST	2225.06	2485.38	2711.70	2753.04	2794.40	3806.56	4144.76	5083.92	3857.66	4755.46
Fully-Loaded Mobile Lounge											
Includes grommet, tablet arm, cup holder	4855-0043-GX	\$2354.01	\$2484.17	\$2597.33	\$2618.00	\$2638.68	\$3144.76	\$3313.86	\$3783.44	\$3170.31	\$3619.21
Includes grommet, shelf, tablet arm and cup holder	4855-0043-GSX	2579.07	2709.23	2822.39	2843.06	2863.74	3369.82	3538.92	4008.50	3395.37	3844.27
Includes grommet, tablet arm, cup holder in two fabrics/two colors	4855-0043-GTX	2354.01	2614.33	2840.65	2881.99	2923.35	3935.51	4273.71	5212.87	3986.61	4884.41
Includes grommet, shelf, tablet arm and cup holder in two fabrics/two colors of same fabric	4855-0043-GSTX	2579.07	2839.39	3065.71	3107.05	3148.41	4160.57	4498.77	5437.93	4211.67	5109.47

The following options require modification of the product number.

Soft Casters

Fully-Loaded

Stain Repellent

Moisture Barrier with Stain Repellent

Leather Upholstery

To specify, add **-2** to product number; **Example:** 4855-0043-2GST

To specify, add **X** to product number; **Example:** 4855-0043-GX

To specify, add **P** to product number; **Example:** 4855-0043-SP (add \$63.25)

To specify, add **D** to the end of the product number; **Example:** 4855-0043-SD (add \$99.75 list)

To specify, change the 2nd digit in the product number from an **8** to a **7** and specify the leather surface and color; **Example:** 4755-0043

NOTE: Stain repellent and moisture barrier are not available on leather or faux leather.

For available fabrics, refer to surfaces.haworth.com.

Hello Seating

Accessories



4858-0001
(Tablet Arm)

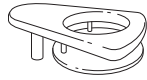

4858-0002
(Cup Holder)

Dimensions

Tablet Arm:
W: 12.68"(322.1mm)
L: 15"(381mm)

Cup Holder:
W: 5.47"(138.94mm)
L: 7.47"(189.61mm)

Features

- Plywood construction.
- Accessories are non-handed.
- Tablet arm and cup holder supports are available in TR-LE Metallic Silver only.

To Order, Specify:

- 1) Product number.
- 2) Wood finish color.
- 3) Trim color for metal trim.
(Available in TR-LE Metallic Silver Only)

Description	Number	Price
Fold Away Tablet Arm	4858-0001	\$248.18
Cup Holder	4858-0002	141.12

Mini-mobile

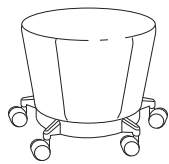

4856-0043

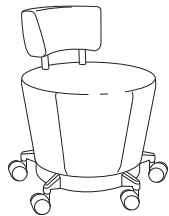

4856-0043-A

Dimensions

SH: 17 1/2"(445mm)
SD: 19 1/2"(495mm)

H: 26 3/4"(679mm)
AH: 9 1/4"(235mm)
OH: 26"(660mm)

Features

- Available as single upholstered seat or seat with arm bolster.
- Casters: Standard with two-tone hard casters.
- Optional two-tone soft casters.
- Optional arm bolster.
- Optional two fabrics / colors of same fabric available on arm bolster and seat.
- COM yardage / COL square footage:
Mini-mobile: 1.0/18.0
Mini w/ Arm Bolster: 1.5/27.0
Arm Bolster: 0.5/9.0

To Order, Specify:

- 1) Product number.
- 2) Fabric surface and color.
or 2a. Fabric surface and color for seat.
2b. Fabric surface and color for arm bolster.
- 3) Trim color for base.
(Available in TR-LE Metallic Silver Only)

Description	Number	Fabric Grade								Leather Grade A	Leather Grade B
		A	B	C	D	E	F	G	H		
Upholstered/One Fabric and Color											
Armless	4856-0043	\$ 847.92	\$ 978.08	\$1091.24	\$1111.91	\$1132.59	\$1144.76	\$1209.22	\$1384.41	\$1664.22	\$2113.12
Includes Arm Bolster	4856-0043-A	1104.62	1234.78	1347.94	1368.61	1389.29	1401.46	1465.92	1641.11	1920.92	2369.82
Upholstered/Two Fabrics or One Fabric, Two Colors											
Includes Arm Bolster	4856-0043-AT	1104.62	1364.94	1591.26	1632.60	1673.96	1698.30	1827.22	2177.60	2737.22	3635.02

The following options require modification of the product number.

Soft Casters

Stain Repellent

Moisture Barrier with Stain Repellent

Leather Upholstery

To specify, add **-2** to product number; **Example:** 4856-0043-2A

To specify, add **P** to product number; **Example:** 4856-0043-AP (add **\$37.71** list)

To specify, add **D** to the end of the product number; **Example:** 4856-0043-AD (add **\$49.87** list)

To specify, change the 2nd digit in the product number from an **8** to a **7** and specify the leather surface and color; **Example:** 4756-0043

NOTE: Stain repellent and moisture barrier are not available on leather or faux leather.

For available fabrics, refer to surfaces.haworth.com.

Hello Seating

Guest Seating

Fixed Arm, Wood Legs



4851-0011-W

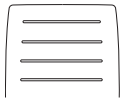

4851-0012-W

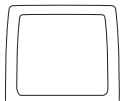

4851-0013-W

Dimensions

- SH: 18 1/4"(464mm)
- H: 33"(838mm)
- D: 20 1/2"(521mm)
- W: 22"(559mm)
- AH: 8"(203mm)
- SW: 18"(457mm)
- SD: 17 1/4"(438mm)

Features

- Wood or upholstered back.
- Wood legs.
- Upholstered seat.
- Non-stacking.
- Maple frame construction.
- Metal back arm attachment.
- Open arms.
- Back Options include wood slat, wood perforated or upholstered.
- COM yardage / COL square footage:
Upholstered seat or upholstered seat/back: 0.75/13.5

To Order Chair with Wood Back, Specify:

- 1) Product number.
- 2) Fabric surface and color (seat).
- 3) Wood finish color (back and legs).
- 4) Trim color for back attachment. **(Available in TR-LE Metallic Silver Only)**

To Order Chair with Upholstered Back, Specify:

- 1) Product number.
- 2) Fabric surface and color.
- 3) Wood finish color (back and legs).
- 4) Trim color for back attachment. **(Available in TR-LE Metallic Silver Only)**

Description	Number	Fabric Grade								Leather Grade A	Leather Grade B
		A	B	C	D	E	F	G	H		
Wood Perforated Back	4851-0011-W	\$1237.21	\$1260.32	\$1270.06	\$1294.38	\$1311.41	\$1485.39	\$1537.69	\$1684.90	\$1570.55	\$1755.11
Wood Slat Back	4851-0012-W	1237.21	1260.32	1270.06	1294.38	1311.41	1485.39	1537.69	1684.90	1570.55	1755.11
Upholstered Back	4851-0013-W	1538.92	1562.03	1571.77	1596.09	1613.12	1787.10	1839.40	1986.61	1872.26	2056.82

The following options require modification of the product number.

CAL 133

Stain Repellent

Moisture Barrier with Stain Repellent

Leather Upholstery

To specify, add **F** to the end the product number (add **107.06** list); **Example:** 4851-0011-WF

To specify, add **P** to product number; **Example:** 4851-0011-WP (add **\$37.71** list)

To specify, add **D** to the end of the product number; **Example:** 4851-0011-WD (add **\$49.87** list)

To specify, change the 2nd digit in the product number from an **8** to a **7** and specify the leather surface and color; **Example:** 4751-0011-W

NOTE: Stain repellent and moisture barrier are not available on leather or faux leather.

For available fabrics, refer to surfaces.haworth.com.

Hello Seating

Guest Seating

Fixed Arm, Metal Legs

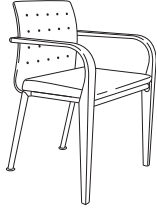

4851-0011

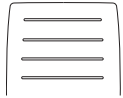

4851-0012

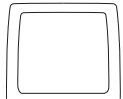

4851-0013

Dimensions

SH: 18 1/4"(464mm)
 H: 33"(838mm)
 D: 20 1/2"(521mm)
 W: 22"(559mm)
 AH: 8"(203mm)
 SW: 18"(457mm)
 SD: 17 1/4"(438mm)

Features

- Wood or upholstered back.
- Wood front legs with metal rear legs.
- Upholstered seat.
- Non-stacking.
- Maple frame construction.
- Metal back arm attachment.
- Open arms.
- Back Options include wood slat, wood perforated or upholstered.
- COM yardage / COL square footage:
 Upholstered seat or upholstered seat / back: 0.75/13.5

To Order Chair with Wood Back, Specify:

- 1) Product number.
- 2) Fabric surface and color (seat).
- 3) Wood finish color for back, arms, and front legs.
- 4) Trim color for rear legs and back attachment.
(Available in TR-LE Metallic Silver Only)

To Order Chair with Upholstered Back, Specify:

- 1) Product number.
- 2) Fabric surface and color.
- 3) Wood finish color for back, arms, and front legs.
- 4) Trim color for rear legs and back attachment.
(Available in TR-LE Metallic Silver Only)

Description	Number	Fabric Grade								Leather Grade A	Leather Grade B
		A	B	C	D	E	F	G	H		
Wood Perforated Back	4851-0011	\$1126.52	\$1149.63	\$1159.37	\$1183.69	\$1200.72	\$1374.70	\$1427.00	\$1574.21	\$1459.86	\$1644.42
Wood Slat Back	4851-0012	1126.52	1149.63	1159.37	1183.69	1200.72	1374.70	1427.00	1574.21	1459.86	1644.42
Upholstered Back	4851-0013	1428.23	1451.34	1461.08	1485.40	1502.43	1676.41	1728.71	1875.92	1761.57	1946.13

The following options require modification of the product number.

CAL 133

Stain Repellent

Moisture Barrier with Stain Repellent

Leather Upholstery

To specify, add **-F** to the end the product number (add **107.06** list); **Example:** 4851-0011-F

To specify, add **-P** to product number; **Example:** 4851-0011-P (add **\$37.71** list)

To specify, add **-D** to the end of the product number; **Example:** (add **\$49.87** list)

To specify, change the 2nd digit in the product number from an **8** to a **7** and specify the leather surface and color;
Example: 4751-0011

NOTE: Stain repellent and moisture barrier are not available on leather or faux leather.

For available fabrics, refer to surfaces.haworth.com.

Hello Seating

Stools

**Fixed Arm,
Metal Legs**

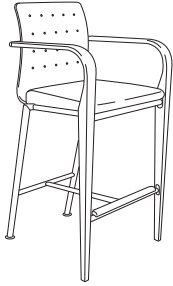

4852-0011

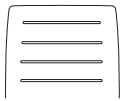

4852-0012

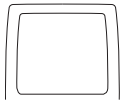

4852-0013

Dimensions

- SH: 28 1/2"(724mm)
- H: 44"(1118mm)
- D: 21"(533mm)
- W: 20 3/4"(527mm)
- AH: 8 1/2"(216mm)
- SW: 17 1/4"(438mm)
- SD: 17 1/4"(438mm)

Features

- Wood or upholstered back.
- Upholstered seat.
- Maple frame construction.
- Metal back leg construction.
- Open arms.
- Metal back arm attachment.
- Foot rest nylon cover available in black only.
- Back Options include wood slat, wood perforated or upholstered.
- COM yardage / COL square footage: Upholstered seat or upholstered seat/back: 0.75/13.5

**To Order Chair with
Wood Back, Specify:**

- 1) Product number.
- 2) Fabric surface and color (seat).
- 3) Wood finish color for back, arms, and front legs.
- 4) Trim color for rear legs and back attachment.
(Available in TR-LE Metallic Silver Only)

**To Order Chair with
Upholstered Back, Specify:**

- 1) Product number.
- 2) Fabric surface and color.
- 3) Wood finish color for back, arms, and front legs.
- 4) Trim color for rear legs and back attachment.
(Available in TR-LE Metallic Silver Only)

Description	Number	Fabric Grade								Leather Grade A	Leather Grade B
		A	B	C	D	E	F	G	H		
Wood Perforated Back	4852-0011	\$1441.61	\$1464.72	\$1474.46	\$1498.78	\$1515.81	\$1689.79	\$1742.09	\$1889.30	\$1774.95	\$1959.51
Wood Slat Back	4852-0012	1441.61	1464.72	1474.46	1498.78	1515.81	1689.79	1742.09	1889.30	1774.95	1959.51
Upholstered Back	4852-0013	1743.32	1766.43	1776.17	1800.49	1817.52	1991.50	2043.80	2191.01	2076.66	2261.22

The following options require modification of the product number.

CAL 133

Stain Repellent

Moisture Barrier with Stain Repellent

Leather Upholstery

To specify, add **-F** to the end the product number (add **107.06** list); **Example:** 4852-0011-F

To specify, add **-P** to product number; **Example:** 4852-0011-P (add **\$37.71** list)

To specify, add **-D** to the end of the product number; **Example:** 4852-0011-D (add **\$49.87** list)

To specify, change the 2nd digit in the product number from an **8** to a **7** and specify the leather surface and color; **Example:** 4752-0011

NOTE: Stain repellent and moisture barrier are not available on leather or faux leather.

For available fabrics, refer to surfaces.haworth.com.

ToDo

General Specifications

Features and Options**Frame**

- Combination of hardwood rails, premium grade plywood and engineering grade oriented strand board
- The seat, back and arms use a box construction method. Each box is then fastened together using metal T-nuts.
- Optional back handle (single seat only)

Cushioning

- High-density foam
- Webbed seat and back

Upholstery

- One Fabric
- Two Fabrics (first fabric on seat, back and ottoman; second fabric on arm structures)
- Faux Leather
- Leather

Seat Options

- Single
- Double
- Triple

Base Options

- Stationary
 - 2 metal legs front and rear
- Mobile (single seat only)
 - 2 twin-wheel casters front, 2 metal legs rear

Accessory Options

- Tablet
- Cup holder
- Grommet cover

Grommet Options

- None (no cut-outs in arms)
- Right Arm (as seated)
- Left Arm (as seated)
- Both Arms

Ottoman or Shelf Option

- Open compartment (standard)
- Painted or Wood Veneer Shelf
 - chairs with a shelf will not accept an ottoman
- Painted or Wood Veneer Mobile Ottoman
 - Upholstered
 - Non-upholstered wood top
 - 4 twin-wheel casters
 - chairs with an ottoman will not accept a shelf
 - ottoman nests under single seat with open compartment only

COM & COL General Information

To order a COM fabric (Customer's Own Material), contact the Haworth Inquiry Center (1.800.426.8562), your local Haworth dealer, or go to haworth.com/surfaces > COM Library to find out if the COM you have selected has already been tested and approved. The surface collection site also has information on the Haworth + alliance program with Carnegie, Luna Textiles, and Maharam as well as our industry-leading Pre-Approved COM program.

COM fabrics are placed into Grades based on the cost per linear yard. If a fabric's cost exceeds the range of our highest Grade it will be noted as Non-Graded. The product will be priced at Grade A; the COM fabric costs will appear as a separate line item. The fabric charge will be Haworth's purchase cost plus a 4% administrative fee (based on the cost of the fabric). Yardage calculations will include any applicable fabric repeat.

COM Leather products will be priced at a leather Grade A; COL costs will appear as a separate line item. The leather costs will be Haworth's purchase cost plus a 4% administrative fee (based on the cost of the leather).

Specification Guidelines

- When more than two fabrics are specified on a ToDo chair contact Haworth Specials for pricing and lead time.
- Mixing of materials such as vinyl and fabric on chair contact specials for pricing.
- When ordering a chair with both the two fabric option and an upholstered ottoman, the fabric on the ottoman will match the fabric on the chair seat and back indicated in the first fabric code. The chair arms will be upholstered in the second fabric code.
- If an upholstered ottoman fabric must match the chair arms or is a third fabric choice, the ottoman must be ordered separately.
- Chairs with a shelf will not accept an ottoman.
- Chairs with an ottoman will not accept a shelf.
- **A grommet option (suffix -R, -L or -B) must be included in the ToDo chair specification in order to accept tablet arms or cup holders.**
- Tablet arms and cup holders must be ordered separately.

To insure order accuracy and acceptance, features and options must be specified in the following order (top-down):

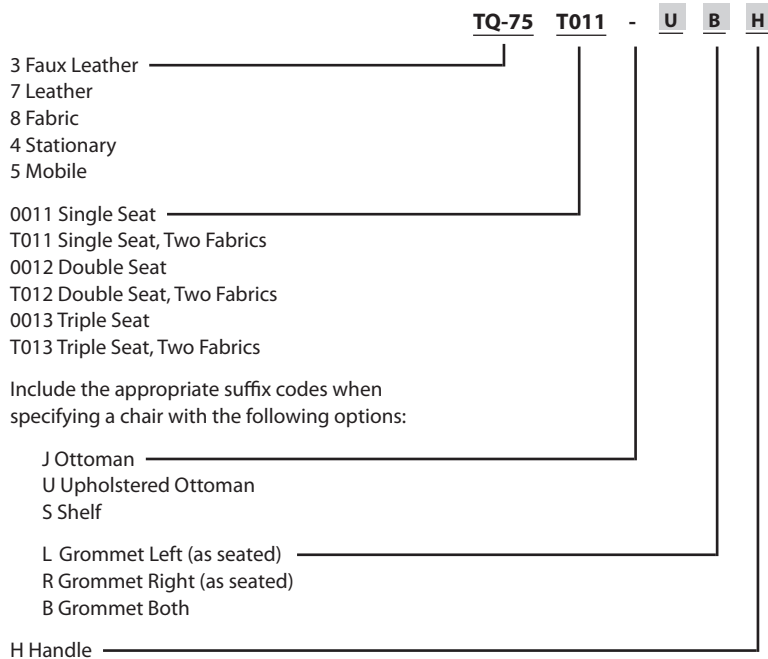

- ToDo Leather, Mobile, Single Seat with two fabrics, Upholstered Ottoman, Grommet Both, Handle

Examples:

TQ84-0012-SL, NQ-8, TR-M01, H3-1

ToDo Fabric, Stationary, Double Seat, Shelf, Grommet Left
 Moodring Fabric Joy
 Switch Silver trim on feet
 Lameer™ Snow on Shelf

TQ85-0011-BHF, ED-99, TR-F

ToDo Fabric, Mobile, Single Seat, Grommet Both, Handle
 Novial fabric Black
 Black trim on feet, grommets and handle
 CAL 133 required (when -F is specified, always verify fabric selected is CAL 133 approved.)

ToDo

Single, Stationary

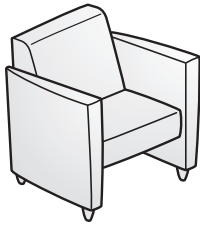

TQ84-0011

Dimensions

Overall:

H	31 1/4"(794mm)
W	30"(762mm)
D	29 1/4"(743mm)

Seat:

H	17 1/2"(445mm)
W	21 1/2"(546mm)
D	19"(483mm)

Arm:

H	24 1/8"(613mm)
---	----------------

Features

- Standard without grommets.
- COM yardage / COL square footage:
ToDo Single: 5.0/96.0
Seat and Back: 4.0/72.0
Arms Only: 3.0/54.0
Ottoman: 0.5/11.0

Specification Tips

- For help in specifying multiple options, refer to page 307.
- When specifying mixed grade fabrics, list price will not exceed the highest grade fabric specified.
- Chairs with a shelf will not accept an ottoman, and chairs with an ottoman will not accept a shelf.
- **A grommet option (suffix -R, -L or -B) must be included in the ToDo chair specification in order to accept tablet arms or cup holders.**
- Cup holders and tablet must be ordered separately. To specify, refer to page 312.

To Order, Specify:

- 1) Product number.
- 2) Fabric or
a. Fabric for seat, back and upholstered ottoman.
b. Fabric for arms.
- 3) Trim color for feet, grommets and handle.
- 4) Wood Veneer finish color for shelf or ottoman.

Description	Number	Fabric Grade								Leather Grade A	Leather Grade B
		A	B	C	D	E	F	G	H		
One Fabric											
Standard	TQ84-0011	\$2414.82	\$2492.66	\$2619.22	\$2704.38	\$3001.20	\$3402.64	\$3611.88	\$4198.28	\$3772.48	\$4523.50
With Ottoman	TQ84-0011-J	3154.48	3232.32	3358.88	3444.04	3740.86	4142.30	4351.54	4937.94	4512.14	5263.16
With Upholstered Ottoman	TQ84-0011-U	3298.03	3375.87	3502.43	3587.59	3884.41	4285.85	4495.09	5081.49	4655.69	5406.71
With Shelf	TQ84-0011-S	2603.38	2681.22	2807.78	2892.94	3189.76	3591.20	3800.44	4386.84	3961.04	4712.06
With Grommet Right	TQ84-0011-R	2451.31	2529.15	2655.71	2740.87	3037.69	3439.13	3648.37	4234.77	3808.97	4559.99
With Grommet Left	TQ84-0011-L	2451.31	2529.15	2655.71	2740.87	3037.69	3439.13	3648.37	4234.77	3808.97	4559.99
With Grommet Both	TQ84-0011-B	2487.80	2565.64	2692.20	2777.36	3074.18	3475.62	3684.86	4271.26	3845.46	4596.48
With Handle	TQ84-0011-H	2491.46	2569.30	2695.86	2781.02	3077.84	3479.28	3688.52	4274.92	3849.12	4600.14
Two Fabrics											
Standard	TQ84-T011	\$2497.55	\$2575.39	\$2701.95	\$2787.11	\$3083.93	\$3485.37	\$3694.61	\$4281.01	\$3855.21	\$4606.23
With Ottoman	TQ84-T011-J	3237.21	3315.05	3441.61	3526.77	3823.59	4225.03	4434.27	5020.67	4594.87	5345.89
With Upholstered Ottoman	TQ84-T011-U	3380.76	3458.60	3585.16	3670.32	3967.14	4368.58	4577.82	5164.22	4738.42	5489.44
With Shelf	TQ84-T011-S	2686.11	2763.95	2890.51	2975.67	3272.49	3673.93	3883.17	4469.57	4043.77	4794.79
With Grommet Right	TQ84-T011-R	2534.04	2611.88	2738.44	2823.60	3120.42	3521.86	3731.10	4317.50	3891.70	4642.72
With Grommet Left	TQ84-T011-L	2534.04	2611.88	2738.44	2823.60	3120.42	3521.86	3731.10	4317.50	3891.70	4642.72
With Grommet Both	TQ84-T011-B	2570.53	2648.37	2774.93	2860.09	3156.91	3558.35	3767.59	4353.99	3928.19	4679.21
With Handle	TQ84-T011-H	2574.19	2652.03	2778.59	2863.75	3160.57	3562.01	3771.25	4357.65	3931.85	4682.87

The following options require modification of the product number.

Faux Leather

Leather

Stain repellent

Moisture Barrier with Stain Repellent

To specify, change the 3rd digit from an 8 to a 3; **Example:** TQ34-0011

To specify, change the 3rd digit from an 8 to a 7; **Example:** TQ74-0011

To specify, add **-P** to the end of the product number; **Example:** TQ84-0011-P (add **\$63.25** list)

To specify, add **-D** to the end of the product number; **Example:** TQ84-0011-D (add **\$99.75** list)

For available fabrics, refer to surfaces.haworth.com.

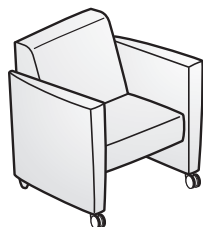

TQ85-0011

Dimensions

Overall:

H 31 1/4"(794mm)
W 30"(762mm)
D 29 1/4"(743mm)

Seat:

H 17 1/2"(445mm)
W 21 1/2"(546mm)
D 19"(483mm)

Arm:

H 24 1/4"(613mm)

Features

- Standard without grommets.
- COM yardage / COL square footage:
ToDo Single: 5.0/96.0
Seat and Back: 4.0/72.0
Arms Only: 3.0/54.0
Ottoman: 0.5/11.0

To Order, Specify:

- 1) Product number.
- 2) Fabric or
a. Fabric for seat, back and upholstered ottoman.
b. Fabric for arms.
- 3) Trim color for feet, grommets and handle.
- 4) Wood Veneer finish color for shelf or ottoman.

Specification Tips

- For help in specifying multiple options, refer to page 307.
- When specifying mixed grade fabrics, list price will not exceed the highest grade fabric specified.
- Chairs with a shelf will not accept an ottoman, and chairs with an ottoman will not accept a shelf.
- **A grommet option (suffix -R, -L or -B) must be included in the ToDo chair specification in order to accept tablet arms or cup holders.**
- Cup holders and tablet must be ordered separately. To specify, refer to page 312.

Description	Number	Fabric Grade								Leather Grade A	Leather Grade B
		A	B	C	D	E	F	G	H		
One Fabric											
Standard	TQ85-0011	\$2414.82	\$2492.66	\$2622.84	\$2709.24	\$3001.20	\$3402.64	\$3616.76	\$4201.94	\$3773.72	\$4521.18
With Ottoman	TQ85-0011-J	3294.37	3372.21	3502.39	3588.79	3880.75	4282.19	4496.31	5081.49	4653.27	5400.73
With Upholstered Ottoman	TQ85-0011-U	3298.02	3375.86	3506.04	3592.44	3884.40	4285.84	4499.96	5085.14	4656.92	5404.38
With Shelf	TQ85-0011-S	2603.38	2681.22	2811.40	2897.80	3189.76	3591.20	3805.32	4390.50	3962.28	4709.74
With Grommet Right	TQ85-0011-R	2451.31	2529.15	2659.33	2745.73	3037.69	3439.13	3653.25	4238.43	3810.21	4557.67
With Grommet Left	TQ85-0011-L	2451.31	2529.15	2659.33	2745.73	3037.69	3439.13	3653.25	4238.43	3810.21	4557.67
With Grommet Both	TQ85-0011-B	2487.82	2565.66	2695.84	2782.24	3074.20	3475.64	3689.76	4274.94	3846.72	4594.18
With Handle	TQ85-0011-H	2491.46	2569.30	2699.48	2785.88	3077.84	3479.28	3693.40	4278.58	3850.36	4597.82
Two Fabrics											
Standard	TQ85-T011	\$2497.55	\$2575.39	\$2705.57	\$2791.97	\$3083.93	\$3485.37	\$3699.49	\$4284.67	\$3856.45	\$4603.91
With Ottoman	TQ85-T011-J	3377.10	3454.94	3585.12	3671.52	3963.48	4364.92	4579.04	5164.22	4736.00	5483.46
With Upholstered Ottoman	TQ85-T011-U	3380.75	3458.59	3588.77	3675.17	3967.13	4368.57	4582.69	5167.87	4739.65	5487.11
With Shelf	TQ85-T011-S	2686.11	2763.95	2894.13	2980.53	3272.49	3673.93	3888.05	4473.23	4045.01	4792.47
With Grommet Right	TQ85-T011-R	2534.04	2611.88	2742.06	2828.46	3120.42	3521.86	3735.98	4321.16	3892.94	4640.40
With Grommet Left	TQ85-T011-L	2534.04	2611.88	2742.06	2828.46	3120.42	3521.86	3735.98	4321.16	3892.94	4640.40
With Grommet Both	TQ85-T011-B	2570.55	2648.39	2778.57	2864.97	3156.93	3558.37	3772.49	4357.67	3929.45	4676.91
With Handle	TQ85-T011-H	2574.19	2652.03	2782.21	2868.61	3160.57	3562.01	3776.13	4361.31	3933.09	4680.55

The following options require modification of the product number.

- Faux Leather
- Leather
- Stain repellent
- Moisture Barrier with Stain Repellent

To specify, change the 3rd digit from an 8 to a 3; **Example:** TQ35-0011

To specify, change the 3rd digit from an 8 to a 7; **Example:** TQ75-0011

To specify, add **-P** to the end of the product number; **Example:** TQ85-0011-P (**\$63.25** list)

To specify, add **-D** to the end of the product number; **Example:** TQ85-0011-D (add **\$99.75** list)

For available fabrics, refer to surfaces.haworth.com.

ToDo

Double, Stationary

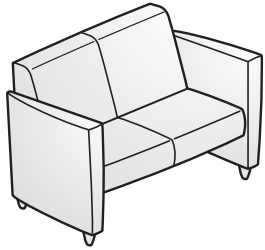

TQ84-0012

Dimensions

Overall:
 H 31 1/4"(794mm)
 W 51"(1295mm)
 D 30 3/4"(781mm)
 Seat:
 H 17 1/2"(445mm)
 W 42 1/2"(1080mm)
 D 20 1/2"(521mm)
 Arm:
 H 24 1/8"(613mm)

Features

- Standard without grommets.
- COM yardage / COL square footage:
 ToDo Double: 8.0/144.0
 Seat and Back: 7.0/126.0
 Arms Only: 3.0/54.0

To Order, Specify:

- 1) Product number.
- 2) Fabric or
 a. Fabric for seat and back.
 b. Fabric for arms.
- 3) Trim color for feet and grommets.
- 4) Wood Veneer finish color for shelf.

Specification Tips

- For help in specifying multiple options, refer to page 307.
- When specifying mixed grade fabrics, list price will not exceed the highest grade fabric specified.
- **A grommet option (suffix -R, -L or -B) must be included in the ToDo chair specification in order to accept tablet arms or cup holders.**
- Cup holders and tablet must be ordered separately. To specify, refer to page 312.
- Handle and ottoman options are not available on the ToDo Double.

Description	Number	Fabric Grade		C	D	E	F	G	H	Leather Grade A	Leather Grade B
		A	B								
One Fabric											
Standard	TQ84-0012	\$3543.78	\$3667.88	\$3877.08	\$4015.78	\$4478.08	\$5125.28	\$5465.92	\$6402.64	\$5716.54	\$6915.34
With Shelf	TQ84-0012-S	3732.34	3856.44	4065.64	4204.34	4666.64	5313.84	5654.48	6591.20	5905.10	7103.90
With Grommet Right	TQ84-0012-R	3580.27	3704.37	3913.57	4052.27	4514.57	5161.77	5502.41	6439.13	5753.03	6951.83
With Grommet Left	TQ84-0012-L	3580.27	3704.37	3913.57	4052.27	4514.57	5161.77	5502.41	6439.13	5753.03	6951.83
With Grommet Both	TQ84-0012-B	3616.76	3740.86	3950.06	4088.76	4551.06	5198.26	5538.90	6475.62	5789.52	6988.32
Two Fabrics											
Standard	TQ84-T012	\$3677.60	\$3801.70	\$4010.90	\$4149.60	\$4611.90	\$5259.10	\$5599.74	\$6536.46	\$5850.36	\$7049.16
With Shelf	TQ84-T012-S	3866.16	3990.26	4199.46	4338.16	4800.46	5447.66	5788.30	6725.02	6038.92	7237.72
With Grommet Right	TQ84-T012-R	3714.09	3838.19	4047.39	4186.09	4648.39	5295.59	5636.23	6572.95	5886.85	7085.65
With Grommet Left	TQ84-T012-L	3714.09	3838.19	4047.39	4186.09	4648.39	5295.59	5636.23	6572.95	5886.85	7085.65
With Grommet Both	TQ84-T012-B	3750.58	3874.68	4083.88	4222.58	4684.88	5332.08	5672.72	6609.44	5923.34	7122.14

The following options require modification of the product number.

- | | |
|---------------------------------------|---|
| Faux Leather | To specify, change the 3rd digit from an 8 to a 3; Example: TQ34-0012 |
| Leather | To specify, change the 3rd digit from an 8 to a 7; Example: TQ74-0012 |
| Stain repellent | To specify, add -P to the end of the product number; Example: TQ84-0012-P (add \$126.50 list) |
| Moisture Barrier with Stain Repellent | To specify, add -D to the end of the product number; Example: TQ84-0012-D (add \$199.50 list) |
| | For available fabrics, refer to surfaces.haworth.com . |

ToDo
Triple, Stationary

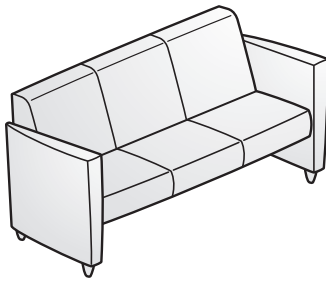

TQ84-0013

Dimensions

Overall:
 H 31 1/4"(794mm)
 W 73"(1854mm)
 D 30 3/4"(781mm)
 Seat:
 H 17 1/2"(445mm)
 W 64 1/2"(1638mm)
 D 20 1/2"(521mm)
 Arm:
 H 24 1/8"(613mm)

Features

- Standard without grommets.
- COM yardage / COL square footage:
 ToDo Triple: 11.0/198.0
 Seat and Back: 9.0/162.0
 Arms Only: 3.0/54.0

To Order, Specify:

- 1) Product number.
- 2) Fabric or
 a. Fabric for seat and back.
 b. Fabric for arms.
- 3) Trim color for feet and grommets.
- 4) Wood Veneer finish color for shelf.

Specification Tips

- For help in specifying multiple options, refer to page 307.
- When specifying mixed grade fabrics, list price will not exceed the highest grade fabric specified.
- **A grommet option (suffix -R, -L or -B) must be included in the ToDo chair specification in order to accept tablet arms or cup holders.**
- Cup holders and tablet must be ordered separately. To specify, refer to page 312.
- Handle and ottoman options are not available on the ToDo Triple.

Description	Number	Fabric Grade								Leather Grade A	Leather Grade B
		A	B	C	D	E	F	G	H		
One Fabric											
Standard	TQ84-0013	\$4366.16	\$4521.90	\$4777.36	\$4954.94	\$5538.90	\$6543.76	\$7008.48	\$8405.08	\$7083.90	\$8581.18
With Shelf	TQ84-0013-S	4554.72	4710.46	4965.92	5143.50	5727.46	6732.32	7197.04	8593.64	7272.46	8769.74
With Grommet Right	TQ84-0013-R	4402.65	4558.39	4813.85	4991.43	5575.39	6580.25	7044.97	8441.57	7120.39	8617.67
With Grommet Left	TQ84-0013-L	4402.65	4558.39	4813.85	4991.43	5575.39	6580.25	7044.97	8441.57	7120.39	8617.67
With Grommet Both	TQ84-0013-B	4439.14	4594.88	4850.34	5027.92	5611.88	6616.74	7081.46	8478.06	7156.88	8654.16
Two Fabrics											
Standard	TQ84-T013	\$4540.14	\$4695.88	\$4951.34	\$5128.92	\$5712.88	\$6717.74	\$7182.46	\$8579.06	\$7257.88	\$8755.16
With Shelf	TQ84-T013-S	4728.70	4884.44	5139.90	5317.48	5901.44	6906.30	7371.02	8767.62	7446.44	8943.72
With Grommet Right	TQ84-T013-R	4576.63	4732.37	4987.83	5165.41	5749.37	6754.23	7218.95	8615.55	7294.37	8791.65
With Grommet Left	TQ84-T013-L	4576.63	4732.37	4987.83	5165.41	5749.37	6754.23	7218.95	8615.55	7294.37	8791.65
With Grommet Both	TQ84-T013-B	4613.12	4768.86	5024.32	5201.90	5785.86	6790.72	7255.44	8652.04	7330.86	8828.14

The following options require modification of the product number.

- Faux Leather: To specify, change the 3rd digit from an 8 to a 3; **Example:** TQ34-0013
 - Leather: To specify, change the 3rd digit from an 8 to a 7; **Example:** TQ74-0013
 - Stain repellent: To specify, add **-P** to the end of the product number; **Example:** TQ84-0013-P (add \$189.75 list)
 - Moisture Barrier with Stain Repellent: To specify, add **-D** to the end of the product number; **Example:** TQ84-0013-D (add \$299.25 list)
- For available fabrics, refer to surfaces.haworth.com.

ToDo

Accessories

Important! Specify for a ToDo chair with grommets. Product number suffix must include R, L or B.

Wood Tablet with Arm

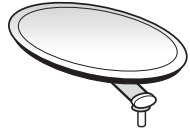

TQ90-0001

Dimensions
 W 11 1/2"(292mm)
 L 19 1/2"(495mm)

To Order, Specify:
 1) Product number.
 2) Trim color for arm assembly.
 3) Wood finish color.

Description	Number	Wood Finish Price
Wood Tablet with Arm	TQ90-0001	\$288.32

Cup Holder

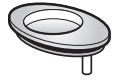

TQ90-0003

Dimensions
 W 4 1/2"(114mm)
 L 7"(178mm)

To Order, Specify:
 1) Product number.
 2) Trim color for arm assembly.
 3) Wood finish color.

Description	Number	Wood Finish Price
Cup Holder	TQ90-0003	\$103.40

Grommet Cover



TQ90-0006

To Order, Specify:
 1) Product number.
 2) Trim color.

Description	Number	Painted Price
Grommet Cover	TQ90-0006	\$59.62

▲ Specification Tip:

- A grommet option (suffix -R, -L or -B) must be included in the ToDo chair specification in order to accept tablet arms or cup holders.

Example: TQ85-0011-JR will accept an accessory on the right arm.

ToDo
Ottoman

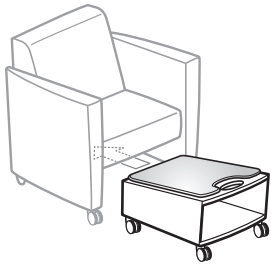

TQ90-0004

Dimensions

W 20"(508mm)
L 21"(533mm)
H 11"(279mm)

Specification Tip

• Chairs with a shelf will not accept an ottoman.

To Order, Specify:

- 1) Product number.
- 2) Fabric.
- 3) Trim color.
- 4) Wood Veneer finish color.



Description	Number	Painted	Fabric Grade		C	D	E	F	G	H	Leather Grade A	Leather Grade B
			A	B								
Non-Upholstered	TQ90-0004	\$739.66										
Upholstered	TQ80-0005		\$883.21	\$922.13	\$963.50	\$1003.65	\$1041.37	\$1074.20	\$1110.70	\$1148.41	\$1246.95	\$1448.61

The following options require modification of the product number.

Faux Leather	To specify, change the 3rd digit from an 8 to a 3; Example: TQ30-0005
Leather	To specify, change the 3rd digit from an 8 to a 7; Example: TQ70-0005

Scamps Series

Children's Furniture

		Number	Price
Chair with Arms	Dimensions	KSCP-5110	\$538.12
	SH: 14"(356mm) H: 25"(635mm) D: 19"(483mm) W: 15 3/4"(400mm) AH: 20"(508mm)	Features	To Order, Specify:
KSCP-5110 (Formerly 700/201)		<ul style="list-style-type: none"> Recommended for ages 4 to 7. Frame dimension is 1 1/8"(29mm) O.D. tubular steel. Back and seat are laminate construction with PVC edges. (Available in standard laminates only.) Feet are capped with integral skinned urethane glides in black only. Carton weight/size: 22 lbs./5.8 cubic ft. 	<ol style="list-style-type: none"> Product number. Laminate color. PVC edge color. Kinkote frame trim color.
Scamps Series	Dimensions	KSTR-24	\$616.24
Round Table	H: 24"(610mm) D: 24"(610mm) W: 24"(610mm)	Features	To Order, Specify:
		<ul style="list-style-type: none"> Shipped K.D. Frame dimension is 1 1/8"(29mm) O.D. tubular steel. Table surface is laminate construction with PVC edge. (Available in standard laminates only.) Feet are capped with nylon glides in black only. Carton weight/size: 30 lbs./6.8 cubic ft. 	<ol style="list-style-type: none"> Product number. Laminate color. PVC edge color. Kinkote frame trim color.
KSTR-24 (Formerly 700/300)			

Tilt
Stool

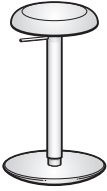
	Number	Price
 <p>STS-1</p> <p>Dimensions SH: 23.5"-34.75" (597mm-883mm) Seat: 12"(305mm) Diameter Base: 14"(356mm) Diameter Col.: 2"(51mm) Diameter</p>	<p>STS-1</p> <p>Features</p> <ul style="list-style-type: none"> • Base: Overmolded structural urethane covered with steel. • Base is rounded to allow movement and allow user to lean on stool. • Seat: Urethane with an MDF substrate. • Seat available in black only. • Steel column with pneumatic height adjustment. • Available in four trim colors. Black (TR-F), Graphite (TR-J), Accent Orange (TR-1E) or Smooth Plaster (TR-PLS). <p>Specification Tips</p> <ul style="list-style-type: none"> • Plant feet firmly on the floor while leaning on the seat. • Rounded base allows movement in any direction. 	<p>To Order, Specify:</p> <ol style="list-style-type: none"> 1) Product number. 2) Trim color. <p>\$1365.09</p>

Finish/Color Legends

Fern

Trim Colors

TR-F	Black
TR-7	Fog
TR-UFM	Snow

Aluminum Colors

TR-MC	Metallic Champagne
TR-LE	Metallic Silver
TR-TF	Pitch
PM-P	Polished Aluminum

Harbor Work Lounge

Base Trim Colors

TR-PLS	Smooth Plaster
TR-F	Black
TR-1E	Accent Orange
PM-P	Polished Aluminum

Cup Holder Trim Colors

TR-AK	Chalk
TR-F	Black

Tablet Arms Laminate

H-WL	Linen
H-AA	Putty
H-8J	Charcoal

Veneer

VR-W35	Clear on Walnut
NR-W35	Clear on Rift Cut White Oak

Noble Wing Material

JA-AR	Arctic	JA-FL	Flagstone
JA-BE	Bird's Egg	JA-FG	Fresh Green
JA-CA	Carbon	JA-LG	Light Gray
JA-CT	Citrus	JA-MA	Marinara
JA-CW	Cornwall	JA-GR	Oxford Gray
JA-EM	Ember	JA-PA	Pachyderm
JA-FA	Fawn		

Hello Seating

Trim Colors

TR-LE	Metallic Silver
-------	-----------------

Improv Series Desk Chairs/Improv H.E. Chairs/Improv H.E. Stool

Trim Colors

TR-F	Black
TR-J	Graphite
TR-G	Gray Tone

Note: Improv Desk and Improv H.E. Chairs with optional high arc base are available in TR-F (Black) trim only.

Improv S.E. and Improv Tag Chairs

Trim Color

TR-F	Black
------	-------

Improv Series Leg-Base/Sled-Base Chairs, Stools and Tables

Trim Colors

TR-F	Black
TR-J	Graphite
TR-G	Gray Tone
TR-E	Smoke

Metallic Trim Colors

TR-MC	Champagne
TR-LE	Silver

Grade A Solid Color Laminates

H-34	Beige
H-AK	Chalk
H-8J	Charcoal
H-3J	Graphite
H-62	Gray Tone
H-WL	Linen
H-3P	Platinum
H-AA	Putty
H-3E	Smoke
H-LC	White Sand

Grade A Wood Grain Laminates

H-AE	Maple
H-AD	Medium Cherry

Grade B Wood Grain Laminates

H-KA	Brazilwood
H-KG	Columbian Walnut
H-KP	Field Elm
H-KN	Grey Elm
H-KM	Landmark Wood
H-KC	New Age Oak
H-KL	Neo Walnut
H-KR	Phantum Ecru
H-KS	Phantum Pearl
H-KD	River Cherry
H-KE	Sanara
H-KF	Williamsburg Cherry

PVC Colors

TR-K0	Black
TR-J	Graphite
TR-G	Gray Tone
TR-E	Smoke

Wood Finish Colors

Maple	
M2-CA1	Amber
M2-W23	American
M2-W04	Beech
M2-W33	Carmel
M2-W15	Espresso
M2-W08	Golden Anegre
M2-W07	Light Anegre
M2-N	Natural
M2-W32	Pacific
M2-W31	Retro
M2-AD	Sand

ALERT: These materials are current, however they are being considered for future obsolescence due to low volume.

Grade A Patterned Laminates

H-DH	Barley Grain
H-22	Grey Spex
H-DA	Oats Grain
H-EK	Owl Nest
H-EC	Quail Nest
H-ED	Rhea Nest
H-EA	Robins Nest
H-DE	Wheat Grain
H-21	White Spex

Wood Finish Colors

Naturally Walnut	M2-W12
------------------	--------

- Note:**
- Specifying a common stain color for casegoods, wood seating, and wood occasional tables will result in a suite of furniture which has a commercially acceptable finish match.
 - Different wood species are offered on the various casegoods, chairs, and tables. Each species offer unique texture, grain, and color of raw wood and veneer. Minor variations in finish color and texture may occur due to these natural characteristics of wood. This is part of the natural beauty of wood and is not considered to be a defect.

Finish/Color Legends

Scamps Series

Metal Finish/Color Legend

Grey Values

TR-F	Black (gloss level 25)
TR-K	Charcoal (gloss level 25)
TR-J	Graphite (gloss level 25)
TR-E	Smoke (gloss level 25)

Taupe Values (gloss level 25)

TR-G	Gray Tone
TR-AA	Putty

Metallic

TR-MC	Metallic Champagne
TR-LE	Metallic Silver

ALERT: These materials are current, however they are being considered for future obsolescence due to low volume.

Laminate/Color Legend

Grade A

Solid Color Laminates

H-34	Beige
H-AK	Chalk
H-8J	Charcoal
H-3J	Graphite
H-62	Gray Tone
H-WL	Linen
H-3P	Platinum
H-AA	Putty
H-3E	Smoke

Grade A

Wood Grain Laminates

H-AE	Maple
H-AM	Amber Cherry
H-AD	Medium Cherry

Grade B

Wood Grain Laminates

H-KA	Brazilwood
H-KG	Columbian Walnut
H-KP	Field Elm
H-KN	Grey Elm
H-KM	Landmark Wood
H-KC	New Age Oak
H-KR	Phantom Ecu
H-KS	Phantom Pearl
H-KC	New Age Oak
H-KL	Neo Walnut
H-KD	River Cherry
H-KE	Sanara
H-KF	Williamsburg Cherry

Plastic Edge Color Legend

TR-R	Beige
TR-AK	Chalk
TR-K	Charcoal
TR-J	Graphite
TR-G	Gray Tone
TR-AA	Putty
TR-E	Smoke

Veneer/Color Legend

M2-W15	Espresso
M2-N	Natural
M2-AD	Sand

Grade A

Patterned Laminates

H-DH	Barley Grain
H-22	Grey Spex
H-DA	Oats Grain
H-EK	Owl Nest
H-EC	Quail Nest
H-ED	Rhea Nest
H-EA	Robins Nest
H-DE	Wheat Grain
H-21	White Spex

- Note:**
- Specifying a common stain color for casegoods, wood seating, and wood occasional tables will result in a suite of furniture which has a commercially acceptable finish match.
 - Different wood species are offered on the various casegoods, chairs, and tables. Each species offer unique texture, grain, and color of raw wood and veneer. Minor variations in finish color and texture may occur due to these natural characteristics of wood. This is part of the natural beauty of wood and is not considered to be a defect.

Lively

Trim Colors

TR-F	Black
------	-------

LOOK Side Chair

Polypropylene Shell Colors

TR-F	Black
TR-W	White

Trim Colors

TR-F	Black
TR-MC	Metallic Champagne
TR-LE	Metallic Silver

Monaco Seating

Trim Colors

TR-F	Black
PN-B	Brushed Aluminum

Openest

Trim Colors

TR-1E	Accent Orange
TR-F	Black
TR-PLS	Smooth Plaster
TR-RR	Rusty Red

Thread Colors

NS-1E	Accent Orange
NS-F	Black
NS-PLS	Plaster
NS-RR	Rusty Red

Table Surfaces - Painted

PW-F	Black
PW-PL	Polar
PW-SY	Stormy
PW-VA	Vapor

Sprig Table Surfaces - Wood

VB-W35	Plank Wood
VH-W35	Plank Walnut

Poppy

Trim Colors

TR-F	Black
TR-PLS	Smooth Plaster

Wood Finishes

M5-W35	Clear on Oak
M6-W35	Clear on Walnut
M7-W43	Ink on Ash

Finish/Color Legends

ToDo Seating

Trim Colors

TR-F	Black
TR-M01	Switch Silver

Maple Veneer Finish

M2-CA1	Amber
M2-W23	American
M2-W04	Beech
M2-W33	Carmel
M2-W15	Espresso
M2-W08	Golden Anegre
M2-W30	Heritage
M2-W07	Light Anegre
M2-W21	Mahogany Satin
M2-N	Natural
M2-W32	Pacific
M2-W31	Retro
M2-AD	Sand

ALERT: These materials are current, however they are being considered for future obsolescence due to low volume.

Maple Veneer Finish

M2-W12 Naturally Walnut

X99

Trim Colors

TR-F	Black
KR-V	Chrome*

Metallic Trim Colors

TR-LE	Silver
-------	--------

*Refer to price pages for chrome specification information and upcharge.

Zody

Aluminum Base and Arm Uprights

Paint Colors

TR-F	Black
TR-RR	Rusty Red
TR-1M	Sable
TR-LE	Metallic Silver
TR-MC	Metallic Champagne
PM-P	Polished Aluminum
KR-V	Trivalent Chrome*

Trim Color

TR-F	Black
TR-E	Smoke
TR-RR	Rusty Red
TR-1M	Sable
TR-UFM	Snow

Wood Back Finish Color

VT-W04	Beech
--------	-------

Plastic Base

TR-F	Black
------	-------

*Trivalent chrome available on Zody guest chair only. Refer to price pages for specification information and upcharge.

Very Perforated and Tetro Back

Polymer Colors

TR-F	Black
TR-FL	Canvas
TR-FK	Cocoa
TR-CF	Coffee (Perforated Back only)
TR-7	Fog
TR-HR	Heron (Perforated Back only)
TR-KL	Kale (Perforated Back only)
TR-FJ	Slate
TR-FM	Snow
TR-FA	Tomato

Trim Color

TR-F	Black
TR-7	Fog

Base Colors - Painted

TR-F	Black
TR-MC	Metallic Champagne
TR-LE	Metallic Silver
PM-P	Polished Aluminum (conference chair only)
KR-V	Trivalent Chrome (wire stacker, side and seminar)

Base Colors - Plastic (conference chair only)

TR-F	Black
TR-7	Fog

Laminate /Color Legend

Grade A

Solid Color Laminates

H-AA	Putty
H-AK	Chalk
H-WL	Linen
H-3E	Smoke
H-3J	Graphite
H-3P	Platinum
H-34	Beige
H-62	Gray Tone
H-8J	Charcoal

Grade A

Wood Grain Laminate

H-AE	Maple
H-AM	Amber Cherry

Very Task

Plastic Trim Color

TR-F	Black
TR-7	Fog
TR-UFM	Snow (arm caps and adjustable levers default to Fog)

Plastic Base

TR-F	Black
TR-7	Fog

Aluminum Base

PM-P	Polished Aluminum
TR-F	Black
TR-MC	Metallic Champagne
TR-LE	Metallic Silver

Aluminum Frame Colors

TR-F	Black
TR-MC	Metallic Champagne
TR-LE	Metallic Silver
TR-FS	Snowfall
PM-P	Polished Aluminum

Wood Seating — pages 276-285, 303-313 The following matrix shows the standard finish offering for each seating product line. Because of the natural properties of wood, variations of grain pattern and finish color can be expected. Haworth carefully selects materials used in the manufacturing of products to promote consistent and acceptable color. Wood is susceptible to color change from exposure to UV rays. Haworth finishes include a UV stabilizer to reduce these effects. Natural finish on Maple is a clear coat only and will show all the characteristics of the wood.	Wood Seating			
	Composites	Forenze	Hello	ToDo
Maple				
Amber (M2-CA1)*	●	●	●	●
American (M2-W23)	●	●	●	●
Beech (M2-W04)*	●	●	●	●
Caramel (M2-W33)	●	●	●	●
Espresso (M2-W15)*	●	●	●	●
Golden Anegre (M2-W08)	●	●	●	●
Heritage (M2-W30)	●	●	●	●
Light Anegre (M2-W07)	●	●	●	●
Mahogany Satin (M2-W21)*	●	●	●	●
Natural (M2-N)	●	●	●	●
Pacific (M2-W32)	●	●	●	●
Retro (M2-W31)*	●	●	●	●
Sand (M2-AD)*	●	●	●	●

*Compatible wood finish color will complement wood casegoods finish color, not necessarily wood species characteristics.

Wood Seating — pages 274-275 Because of the natural properties of wood, variations of grain pattern and finish color can be expected. Haworth carefully selects materials used in the manufacturing of products to promote consistent and acceptable color. Wood is susceptible to color change from exposure to UV rays. Haworth finishes include a UV stabilizer to reduce these effects.	Wood Seating
	Candor
Beech	
Amber (M3-CA1)	●
American (M3-W23)	●
Caramel (M3-W33)	●
Ebony (M3-RE)	●
Espresso (M3-W15)	●
Golden Anegre (M3-W08)	●
Heritage (M3-W30)	●
Light Anegre (M3-W07)	●
Mahogany Satin (M3-W21)	●
Natural (M3-W04)	●
Pacific (M3-W32)	●
Retro (M3-W31)	●
Sand (M3-AD)	●
Sorrel (M3-RC)	●
Wenge (M3-RW)	●

*Compatible wood finish color will complement wood casegoods finish color, not necessarily wood species characteristics.

ALERT: These materials are current, however they are being considered for future obsolescence due to low volume.

Maple
Naturally Walnut M2-W12

Beech
Natural Walnut M3-W12

Fabric Pattern Usage

Haworth seating models are restricted to fabric patterns that meet applicability standards for tailoring. A dot in the matrix below indicates fabric acceptability on seating series or specific models listed. Fabrics are listed alphabetically by grades.

Grade: Pattern (Surface Code)	Series/ Model																				
	Fern	Harbor Work Lounge	Hello	Improv H.E./S.E.	Improv Tag	Improv Desk Chair	Improv Leg-Base/Sled-Base Stool - Upholstered Back	Improv Leg-Base/Sled-Base Stool - Plastic Back	Lively	LOOK	Monaco	Openest	Openest Pillows	Poppy	ToDo	Very/Very Task	X99	Zody	Zody Guest	Wood (Candor)	Wood (All Other Models)
Haworth Fabrics																					
A: Barque (7)	•	•	•	•	•	•	•	•	•	•	•	•	•	•	•	•	•	•	•	•	•
A: Blanket (4H)	•	•	•	•	•	•	•	•	•	•	•	•	•	•	•	•	•	•	•	•	•
A: Dottie (ME)	•	•	•	•	•	•	•	•	•	•	•	•	•	•	•	•	•	•	•	•	•
A: Gauge (1X)	•	•	•	•	•	•	•	•	•	•	•	•	•	•	•	•	•	•	•	•	•
A: Horizon (1N)	•	•	•	•	•	•	•	•	•	•	•	•	•	•	•	•	•	•	•	•	•
A: Morse (4J)	•	•	•	•	•	•	•	•	•	•	•	•	•	•	•	•	•	•	•	•	•
A: Pixel (2A)	•	•	•	•	•	•	•	•	•	•	•	•	•	•	•	•	•	•	•	•	•
A: Tellure (3A)	•	•	•	•	•	•	•	•	•	•	•	•	•	•	•	•	•	•	•	•	•
A: Twist (MM)	•	•	•	•	•	•	•	•	•	•	•	•	•	•	•	•	•	•	•	•	•
A: Wellington Faux Leather (XJ)	•	•	•	•	•	•	•	•	•	•	•	•	•	•	•	•	•	•	•	•	•
A: Zinger (NI)	•	•	•	•	•	•	•	•	•	•	•	•	•	•	•	•	•	•	•	•	•
B: Align (4F)	•	•	•	•	•	•	•	•	•	•	•	•	•	•	•	•	•	•	•	•	•
B: Cocktail (1W)	•	•	•	•	•	•	•	•	•	•	•	•	•	•	•	•	•	•	•	•	•
B: Diagonale (4N)	•	•	•	•	•	•	•	•	•	•	•	•	•	•	•	•	•	•	•	•	•
B: English Tweed (4E)	•	•	•	•	•	•	•	•	•	•	•	•	•	•	•	•	•	•	•	•	•
B: Jewel (MN)	•	•	•	•	•	•	•	•	•	•	•	•	•	•	•	•	•	•	•	•	•
B: Leef (ML)	•	•	•	•	•	•	•	•	•	•	•	•	•	•	•	•	•	•	•	•	•
B: Ramie (4V)	•	•	•	•	•	•	•	•	•	•	•	•	•	•	•	•	•	•	•	•	•
B: Tech (MV)	•	•	•	•	•	•	•	•	•	•	•	•	•	•	•	•	•	•	•	•	•
C: King (LH)	•	•	•	•	•	•	•	•	•	•	•	•	•	•	•	•	•	•	•	•	•
C: Maya (LM)	•	•	•	•	•	•	•	•	•	•	•	•	•	•	•	•	•	•	•	•	•
C: Small Arrow (4L)	•	•	•	•	•	•	•	•	•	•	•	•	•	•	•	•	•	•	•	•	•
D: Big Arrow (4D)	•	•	•	•	•	•	•	•	•	•	•	•	•	•	•	•	•	•	•	•	•
D: Big Diagonale (1K)	•	•	•	•	•	•	•	•	•	•	•	•	•	•	•	•	•	•	•	•	•
D: Class (LE)	•	•	•	•	•	•	•	•	•	•	•	•	•	•	•	•	•	•	•	•	•
D: Cotswold (JB)	•	•	•	•	•	•	•	•	•	•	•	•	•	•	•	•	•	•	•	•	•
D: Dots (6K)	•	•	•	•	•	•	•	•	•	•	•	•	•	•	•	•	•	•	•	•	•
D: Element (4Z)	•	•	•	•	•	•	•	•	•	•	•	•	•	•	•	•	•	•	•	•	•
D: Main Line Flax (6M)	•	•	•	•	•	•	•	•	•	•	•	•	•	•	•	•	•	•	•	•	•
D: Notable (4K)	•	•	•	•	•	•	•	•	•	•	•	•	•	•	•	•	•	•	•	•	•
D: Tangram (LV)	•	•	•	•	•	•	•	•	•	•	•	•	•	•	•	•	•	•	•	•	•
E: Brisa Faux Leather (XG)	•	•	•	•	•	•	•	•	•	•	•	•	•	•	•	•	•	•	•	•	•
Leathers																					
A: Plains Leather (XP)	•	•	•	•	•	•	•	•	•	•	•	•	•	•	•	•	•	•	•	•	•
B: Nature Leather (XE)	•	•	•	•	•	•	•	•	•	•	•	•	•	•	•	•	•	•	•	•	•

Haworth Fabrics/Color Legend

- The following fabrics are available on select Haworth upholstered seating models. Refer to the fabric pattern usage matrix, page 320. (d) = Directional fabric

Fern Mesh 100% Polyester MB-BE Beach MB-CF Cornflower MB-LM Loam MB-MF Moon Flower MB-MU Mulch MB-MR Mushroom MB-PM Peat Moss MB-RR River Rock MB-SE Sedum MB-SL Silver Leaf MB-SU Sunflower	Fabric Grade: A (d) BLANKET 50% Post Consumer Recycled Polyester, 50% Virgin Polyester 4H-BE Beach 4H-BD Bindle 4H-CL Cloak 4H-FE Feather 4H-FW Firewheel 4H-FT Fort 4H-GR Grass 4H-HD Hood 4H-MA Mackinaw 4H-MT Manta 4H-PN Picnic 4H-PC Poncho 4H-SW Swag 4H-SP Sweep 4H-TK Tuck 4H-YA Yawn	Fabric Grade: A TELLURE 100% Polyester 3A-31 Aegean 3A-18 Black 3A-45 Buff 3A-53 Cayenne 3A-40 Chocolate 3A-49 Dove 3A-28 Dynamo 3A-54 Goose 3A-23 Jodhpurs 3A-33 Miami 3A-19 Navy 3A-06 Nickel 3A-34 Ocean 3A-46 Parrot 3A-50 Peel 3A-47 Pumpkin 3A-44 Roan 3A-51 Rust 3A-37 Spring 3A-48 Sprout 3A-52 Sunset 3A-43 Tomato	Fabric Grade: B ALIGN 97% Post Industrial Recycled Nylon, 3% Post Consumer Recycled Nylon 4F-AR Array 4F-FC Focus 4F-LM Limerick 4F-OR Orient 4F-PK Picket 4F-RT Root 4F-SC Scrimmage 4F-SP Spring 4F-TA Tangent 4F-TL Tree Line 4F-WR Wire	Fabric Grade: B (d) JEWEL 77% Post Industrial Recycled Polyester, 23% Post Consumer Recycled Polyester MN-AM Amber MN-A Aquamarine MN-C Citrine MN-E Emerald MN-G Garnet MN-J Jade MN-M Malachite MN-R Ruby MN-S Sapphire MN-TE Tiger's Eye
Improv Tag Back Mesh 53% Elastometric 47% Polyester S0-25 Amber S0-22 Fire S0-24 Lava (Black) S0-13 Leaf S0-09 Silver S0-20 Sky	Fabric Grade: A (d) HORIZON 100% Polyester 1N-001 Beeline 1N-004 Birdseye 1N-003 Border 1N-002 Compass 1N-005 Panorama 1N-008 Skyline 1N-006 Sweep 1N-007 Vista	Fabric Grade: A (d) TWIST 80% Post Consumer Recycled Polyester, 20% from Rayon Bamboo MM-AS And Shout MM-C Coil MM-CS Corkscrew MM-CU Curl MM-D DNA MM-I Ivy MM-P Plot MM-SW Sidewinder MM-S Snail MM-SP Spire MM-WH Whirlpool MM-W Winding	Fabric Grade: B (d) DIAGONALE 16% Nylon, 84% Polyester 4N-AC Across 4N-BA Bias 4N-CH Chevron 4N-CR Crosscut 4N-DA Diamond 4N-FE Featherstitch 4N-HT Half Timber 4N-KC Kitty Corner 4N-MA Matrix 4N-OB Oblique 4N-SE Serge 4N-ST Slant 4N-SH Slash 4N-SL Slope 4N-WC Whipcord 4N-ZZ Zig Zag	Fabric Grade: B (d) LEEF 49% Post Industrial Recycled Polyester 51% Post Consumer Recycled Polyester ML-A Aspen ML-B Beet ML-C Coca ML-CN Coconut ML-F Fennel ML-HE Henna ML-H Hosta ML-HY Hydrangea ML-M Moonflower ML-PE Petunia ML-P Pumpkin ML-S Sunflower ML-V Violet
Lively Tension Back 100% Polyester 3T-18 Black 3T-40 Chocolate 3T-54 Goose 3T-33 Miami 3T-6 Nickel 3T-46 Parrot 3T-50 Peel 3T-48 Sprout 3T-43 Tomato	Fabric Grade: A (d) MORSE 100% Polyester 4J-BP Blip 4J-CA Cable 4J-CD Code 4J-DA Dash 4J-DT Dot 4J-MA Marconi 4J-RA Radio 4J-SS S.O.S. 4J-SC Scribe 4J-TA Tap 4J-TE Telegraph 4J-TR Transmit 4J-WL Wireless	Fabric Grade: A WELLINGTON FAUX LEATHER 100% Polyurethane XJ-BL Black XJ-BU Buff XJ-EL Elephant XJ-JA Java XJ-PA Pacific XJ-SA Sage XJ-ST Storm XJ-TA Tangelo XJ-WI Wine	Fabric Grade: B (d) ENGLISH TWEED 92% Polyester, 5% Post Industrial Recycled Polyester, 3% Post Consumer Recycled Polyester 4E-BS Biscuit 4E-BL Blimey 4E-BN Bonnet 4E-CT Cottage 4E-DW Doctor Who 4E-FX Fox 4E-ML My Lady 4E-XD Oxford 4E-PE Pipe 4E-SH Sherry 4E-SN Stilton 4E-ST Stout 4E-TE Tea 4E-TU Tudor	Fabric Grade: B (d) RAMIE 62% Polyester, 25% Post Industrial Recycled Polyester, 13% Post Consumer Recycled Polyester 4V-BS Basket 4V-BT Bast 4V-FX Foxtail 4V-GN Gunnie 4V-HY Hay 4V-MC Macrame 4V-ML Millet 4V-MB Mulberry 4V-RN Rain 4V-RD Reed 4V-RT Root 4V-SS Sack Cloth 4V-SO Sisal 4V-TH Thatch 4V-WT Water 4V-WD Weed
Very Task Mesh 100% Polyester MS-F Black MS-FK Cocoa MS-7 Fog MS-HR Heron MS-KL Kale MS-FJ Slate MS-FM Snow	Fabric Grade: A (d) PIXEL 51% Polyester, 32% Post Industrial Recycled Polyester, 17% Post Consumer Recycled Polyester 2A-BY Byte 2A-DC Dice 2A-DT Dot 2A-EA Easel 2A-FT Flaunt 2A-FC Focus 2A-FL Folio 2A-HM Home 2A-IK Ikon 2A-IM Imagine 2A-ND Node 2A-PM Pomp 2A-RA Raster 2A-SP Spectral 2A-TA Tab 2A-VE Vertex			
X99 Soft Mesh 86% Polyester 14% Polyamide M0-BE Beach M0-BL Black M0-CA Camel M0-FG Fog M0-ST Storm				
Zody Back Mesh 100% Polyester MA-9 Calm MA-2 Comfort MA-5 Gusto MA-10 Hush MA-11 Joy MA-4 Relax MA-1 Support MA-12 Tranquil MA-3 Wellness MA-13 Zen				

Haworth Fabrics/Color Legend

Fabric Grade: B (d)
TECH
100% Post Consumer Recycled Polyester

MV-AI	A.I.
MV-AN	Anatomy
MV-A	Aviation
MV-B	Bionics
MV-C	Cosmos
MV-D	Disc
MV-E	Electric
MV-F	Forestry
MV-L	Logic
MV-P	Optics
MV-RA	Radio
MV-R	Rocket
MV-SF	Sci-Fi
MV-S	Skill
MV-T	Theory
MV-Z	Zoology

Fabric Grade: C (d)
KING
100% Polyester

LH-BE	Beige
LH-DB	Dark Blue
LH-DG	Dark Green
LH-DM	Dark Mustard
LH-GD	Gold
LH-GL	Light Green
LH-LG	Light Grey
LH-MB	Medium Blue
LH-MG	Medium Grey
LH-RD	Red
LH-RG	Orange
LH-WG	Warm Grey

Fabric Grade: C (d)
MAYA
100% Polyester

LM-DB	Dark Blue
LM-GR	Green
LM-GY	Golden Yellow
LM-MG	Medium Cool Grey
LM-WG	Medium Warm Grey
LM-RG	Orange

Fabric Grade: C (d)
SMALL ARROW
46% Virgin Nylon, 54% Post Industrial Recycled Nylon

4L-AR	Archer
4L-BA	Barb
4L-CR	Crossbow
4L-DA	Dart
4L-FL	Fletcher
4L-MA	Mark
4L-NK	Nock
4L-QU	Quiver
4L-RE	Reed
4L-RL	Release
4L-ST	Shaft
4L-SH	Sharp
4L-TA	Target

Fabric Grade: D (d)
BIG ARROW
100% Post Consumer Recycled Polyester

4D-BS	Bisque
4D-BL	Blue
4D-CN	Cool Neutral
4D-DB	Dark Blue
4D-GD	Gold
4D-GR	Green
4D-MG	Medium Grey
4D-RE	Red
4D-SA	Salmon
4D-WN	Warm Neutral

Fabric Grade: D (d)
BIG DIAGONALE
66% Post Consumer Recycled Polyester 34% Post Industrial Recycled Polyester

1K-AM	Amber
1K-BL	Balsam
1K-CR	Carbon
1K-ER	Earth
1K-HN	Henna
1K-MN	Mineral
1K-PR	Parrot
1K-RD	Red
1K-RS	Rosa
1K-SE	Sea
1K-TR	Terracotta
1K-ZF	Zaffer

Fabric Grade: D (d)
CLASS
100% Polyester

LE-DG	Dark Grey
LE-GM	Green Multi
LE-GR	Green
LE-LN	Light Cool Neutral
LE-MB	Medium Blue
LE-MN	Medium Warm Neutral
LE-RR	Reddish Orange

Fabric Grade D
COTSWOLD
100% Wool

JB-AN	Anquilla
JB-BR	Bottlegrass
JB-CA	Camp
JB-DN	Dandelion
JB-ED	Editor Blue
JB-GS	Goldfish
JB-HA	Heart
JB-KE	Kokanee
JB-NE	Nettle Bellflower
JB-PL	Pickeral Weed
JB-SA	Sand
JB-SD	Silver Dollar
JB-SU	Silverbush
JB-SC	Soft Charcoal
JB-TR	Tree
JB-WE	Wheaton

Fabric Grade: D (d)
DOTS
72.7% Post Consumer Recycled Polyester 27.3% Post Industrial Recycled Nylon

6K-CL	Clay
6K-VY	Ivy
6K-LM	Lemon
6K-MN	Mandarin
6K-MS	Mist
6K-NG	Night
6K-SH	Shadow
6K-WT	Water

Fabric Grade: D (d)
ELEMENT
76% Post Consumer Recycled Polyester 24% Rayon

4Z-ER	Earth
4Z-ES	Essence
4Z-FR	Fire
4Z-FS	Fossil
4Z-HR	Herbal
4Z-LG	Logic
4Z-LY	Lyrical
4Z-PL	Pillar
4Z-PT	Poetic
4Z-RR	Rare
4Z-RT	Root
4Z-SC	Scenic
4Z-TH	Thread
4Z-TM	Timeless
4Z-TR	Truth
4Z-WN	Wind

Fabric Grade: D (d)
MAIN LINE FLAX
70% Virgin Wool 30% Flax

6M-AL	Aldgate
6M-AR	Archway
6M-BN	Bank
6M-BY	Bayswater
6M-BT	Bethnal
6M-BR	Brompton
6M-CM	Camden
6M-GL	Goldhawk
6M-LM	Lambeth
6M-LY	Leyton
6M-MN	Monument
6M-ST	Stanmore
6M-TM	Temple
6M-TW	Tower
6M-TF	Tufnell
6M-WS	Westminster

Fabric Grade: D (d)
NOTABLE
28% Virgin Nylon, 72% Post Industrial Recycled Nylon

4K-BR	Bravo
4K-CT	Concert
4K-DR	Dramatic
4K-EN	Entertain
4K-MA	Magic
4K-MT	Matinee
4K-PA	Pantomime
4K-PE	Perform
4K-PL	Play
4K-PT	Plot
4K-PR	Practice
4K-SC	Script
4K-SH	Show
4K-SK	Skit
4K-ST	Star
4K-TH	Theatrical

Fabric Grade: D (d)
TANGRAM
57% Polyester, 28% Post Industrial Recycled Polyester, 15% Post Consumer Recycled Polyester (43% REPREVE)

LV-CL	Clue
LV-EN	Enigma
LV-GU	Guess
LV-MA	Maze
LV-MU	Muse
LV-MT	Mystery
LV-MY	Mystify
LV-UT	Outline
LV-PE	Perplex
LV-PC	Pieces
LV-PU	Puzzle
LV-RD	Riddle
LV-SC	Scrabble
LV-SL	Solve
LV-TE	Teaser
LV-TR	Trick

Fabric Grade: E (d)
BRISA FAUX LEATHER
100% Polyurethane face, 65% Polyester, 35% Rayon Backing

XG-23	Apple Green
XG-22	Ash
XG-3	Aztec
XG-28	Birch
XG-12	Black Onxy
XG-25	Blossom
XG-5	Cambridge Blue
XG-26	Coffee Bean
XG-20	New Sand
XG-18	Night Navy
XG-21	Pompeian Red
XG-1	Salsa
XG-27	Shitake
XG-24	Skyway
XG-17	Sterling Blue
XG-13	White

Leather Grade: A
PLAINS LEATHER

XP-0KX	Atlantis
XP-0KC	Black
XP-0KY	Brown
XP-0KZ	Smoke
XP-0KW	Storm

Leather Grade: B
NATURE LEATHER

XE-0AS	Bark
XE-0AR	Bittersweet
XE-0AP	Chocolate
XE-0AJ	Cream
XE-0AH	Flint
XE-0AK	Ink
XE-0AX	Oats
XE-0AT	Saddle
XE-0AM	Seal
XE-0AL	Shadow
XE-0AW	Truffle
XE-0AN	White

ALERT: These materials are current, however they are being considered for future obsolescence due to low volume.

Fabric Grade: A (d)
BARQUE
69% Polyester, 31% Recycled Polyester (31% REPREVE)

07-AH	Ash
07-AS	Aspen
07-BR	Birch
07-BW	Black Walnut
07-CN	Chestnut
07-GO	Golden Oak
07-RB	Redbud
07-WL	Willow

Fabric Grade: A (d)
DOTTIE
89% Post Industrial Recycled Polyester, 11% Post Consumer Recycled Polyester

ME-CA	Calico
ME-C	Chads
ME-DD	Dew Drops
ME-F	Flecks
ME-M	Morse
ME-P	Pip
ME-PD	Polka Dots
ME-R	Roulette
ME-T	Tabby
ME-Y	Yahtzee

Fabric Grade: A (d)
GAUGE
100% Recycled Polyester

1X-05	Depth
1X-04	Gas
1X-11	Narrow
1X-08	Pressure
1X-02	Rain
1X-12	Sea
1X-13	Standard
1X-10	Test
1X-03	Time
1X-09	Water
1X-06	Weather
1X-01	Wind
1X-07	Wire

Fabric Grade: A (d)
ZINGER
37% Recycled Polyester, 63% Polyester (13% REPREVE)

NI-2	BBQ
NI-17	Beluga
NI-10	Bluegill
NI-8	Chips
NI-11	Classic
NI-16	Concord
NI-13	Frog
NI-15	Glade
NI-9	Grain
NI-12	Granny
NI-4	Gravel
NI-18	Kiwi
NI-20	Mulberry
NI-3	Onion
NI-6	Pacific
NI-1	Roan
NI-21	Tar
NI-7	Wagon
NI-19	Wicker
NI-5	Wolf

Fabric Grade: B (d)
COCKTAIL
100% Eco-Intelligent Polyester
MBDC Cradle to Cradle Gold

1W-12	Black Cow
1W-08	Blue Moon
1W-13	Boilermaker
1W-01	Bubbly
1W-03	Gibson
1W-04	Grasshopper
1W-07	Lounge
1W-16	Margarita
1W-10	Martini
1W-14	Mojito
1W-11	Old Fashion
1W-06	Pink Squirrel
1W-15	Sidcar
1W-09	Stinger
1W-02	Stout
1W-05	Swizzle

Haworth Fabrics/Color Legend

Seating COM Pattern Repeat Information

Haworth will calculate and order COM yardage as needed for seating; however, for bid/quote purposes, please refer to the COM yardage requirements listed by each chair model. These numbers are based on solid or very small scale (under 1" repeat) fabrics.

For fabrics with repeats listed below, additional yardage should be included in your calculations. The additional yardage allows for matching of patterns on the seating.

REPEAT SIZE	ADD ADDITIONAL YARDAGE TO YOUR CALCULATIONS
1"-4"	Add 5%
5"-7"	Add 10%
8"-14"	Add 20%
15"-19"	Add 25%
20"-27"	Add 30%
28"-36"	Add 50%

Haworth+

For information on the Haworth+ alliance program, including images and product availability, please refer to:
[Haworth.com > Surface Collection > Haworth+ Library](#)

Customer's Own Material (COM)

For general Customer's Own Material (COM) information including processes and forms, please refer to:
[Haworth.com > Surface Collection > Resources > COM](#)

For information on approved COM's, please refer to:
[Haworth.com > Surface Collection > COM Library](#)

COM Yardage Requirements

Procedure

To determine if a COM fabric has been approved for use on Haworth product, contact the Haworth Inquiry Center (1.800.426.8562), your local Haworth dealer, or go to Haworth.com/surfaces > COM Library. Haworth will calculate and order fabric unless instructed otherwise. If the dealer is to provide the fabric, they will calculate the yardage needed themselves.

If the fabric is approved, and the directional orientation (directional rightway, directional railroad, or non-directional) of the tested fabric has been confirmed, then refer to the appropriate price page for yardage requirements.

COM Fabric Requirements

The fabric yardage requirements for COMs given for each model are in lineal yards and are based on 54"(1372mm) usable fabric widths. Approximate yardage requirements are shown for each model within the price pages.

For fabrics already approved, with a COM order entry code assigned, Haworth will determine and purchase the yardage needed. If the fabric will be provided by the dealer, and the pattern has a large repeat or stripes, additional yardage will be needed; see the COM Yardage Requirements at the end of this price guide OR contact the COM Department for more information.

COL Leather Requirements

The leather requirements for COL (Customer's Own Leather) will vary depending on the hide size and are based on square footage. Haworth will determine and purchase the leather needed.

Find total number of linear yards required for the order. Add the appropriate percentage shown below to the total yardage to accommodate fabric flaws, wrinkles and other imperfections.

Up to 500 yards	Add 10%
501 to 1000 yards	Add 5%
More than 1000 yards	Add 3%

Directional Rightway:

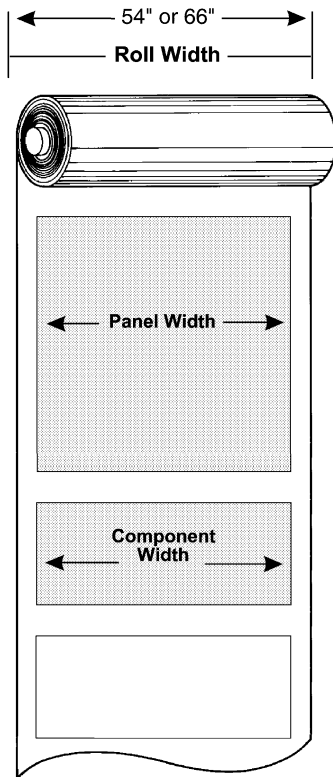

Directional Railroad:

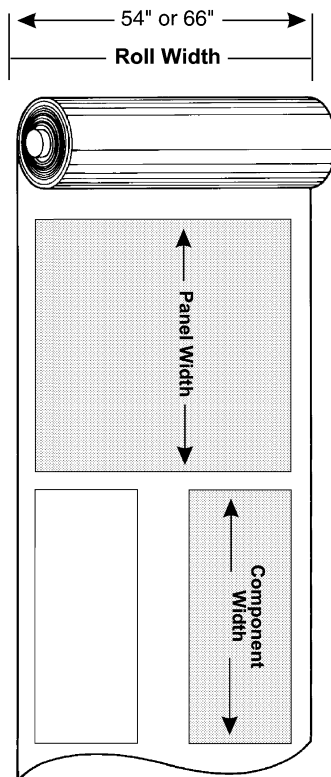

Non-Directional:

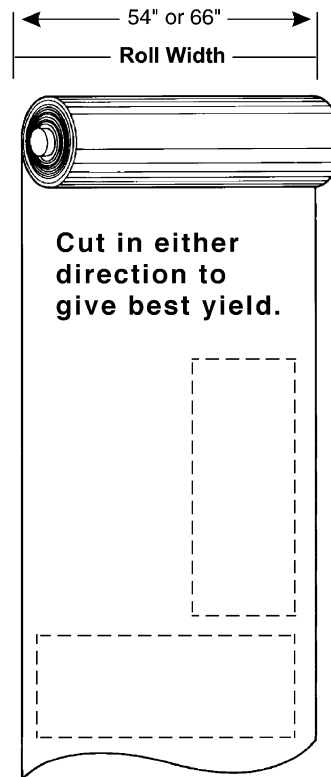

North American Terms of Sale

These Terms of Sale are part of a quotation, bid response, or other sales document issued by Haworth, Inc., Haworth, Ltd. ("Haworth").

These Terms of Sale do not cover products manufactured in North America shipping to non-North American countries nor do they cover products manufactured in non-North American countries shipping to North America. For those terms of sale, please contact Haworth's Global Trade and Compliance Department at 616.393.3000 or through Haworth.com.

A. Ordering Information

Haworth sells its products on the terms set forth in these standard Terms of Sale:

ORDERS MUST BE SUBMITTED IN WRITING OR ELECTRONICALLY (Lynx) AS REPRESENTED BY A VALID PURCHASE ORDER, WHICH INCLUDES PRODUCT TOTAL.

An order is not binding upon Haworth until Haworth issues an order acknowledgment to the customer (the "Customer"), which will include price information and an anticipated delivery date.

1. Order Changes/Cancellations

For Specials, Customer's Own Material (C.O.M.), finish matches, custom colors, custom products, Master lock and key orders, and RUSH orders, no changes or cancellations are allowed 24 hours after order placement. All other products require approval for changes or cancellations. A change/cancellation fee may apply. Contact Order Services for applicable charges.

Ship-to addresses changed within five (5) business days of delivery will incur fees to cover administrative costs due to re-labeling of product and/or reconsignment fees with the carrier.

Order cancellations are complete annulments of orders. Order changes are the deletion of line items or a change in size, color, quantity, ship-to address, or scope of work. There is no penalty for additions; however, any change may cause the order or the line items affected to be rescheduled. Order changes involving additional product and services which increase the value must be accompanied by an amended Purchase Order or other document as agreed.

ALL CHANGES MUST BE IN WRITING, REGARDLESS OF THE (DOLLAR) VALUE. CHANGES ARE NOT BINDING UPON HAWORTH UNTIL HAWORTH ISSUES AN ACKNOWLEDGMENT OF THE CHANGE.

2. C.O.M. (Customer's Own Material)

A Customer who requests a fabric, surface or finish material (C.O.M.) not in Haworth's standard finish offering must first confirm approval of or request new approval for the C.O.M.

Haworth will determine feasibility of the material for manufacturability. For a description of the procedure to submit C.O.M. samples, contact Haworth's Order Services department. For testing information, see the C.O.M. section of the catalog, or call Haworth Order Services.

If Haworth agrees to use the C.O.M., (1) Haworth shall have no responsibility for the condition, quality, value, performance, physical properties, or any other aspect of the C.O.M.; and (2) Haworth shall have no liability for any damages, injuries, or losses to the Customer or to any third party that shall be caused by any C.O.M., and the Customer shall hold Haworth harmless for all such liability.

3. Valid/Complete Purchase Order

The following information is required in order to process an order with Haworth:

a. Customer Information

- i. **Sold To:** Legal name, complete address (if Haworth is to bill the end user, provide end user Purchase Order made out to Haworth, Inc., Haworth, Ltd.) and phone and fax number.
- ii. **Ship To:** Legal name and address.
- iii. **Purchase Order Number:** From the party Haworth will be billing.
- iv. **Authorized Signature:** All Purchase Orders must be signed by a duly authorized representative if a signature line is present. Electronically transmitted Purchase Orders will be accepted without a signature if dealer billed and the dealer has an electronic purchase payment agreement on file.
- v. **Contact Name and Phone Number:** Person Haworth should contact with any questions regarding the order.
- vi. **Shipping Contact:** Name and phone number of person to be contacted regarding shipping and delivery matters.
- vii. **Tagging Instructions:** This information will appear on all documentation received from Haworth including: cartons, acknowledgments, and invoices.
- viii. **Price Agreement or National Sales Agreement Number**
- ix. **Product Total:** Net dollars.
- x. **Installation, Design, Project Management, and/or Service Fees**

b. Product Information

- i. **Quantity**
- ii. **Product Numbers**
- iii. **Colors**
- iv. **Specials:** Specify special part number for new special products.
- v. **Customer's Own Material:** Order entry code, manufacturer, pattern, and color.

- vi. **Approval Drawings:** An authorized signature by a duly authorized representative is required for shop drawings when applicable.
- vii. A deposit may be required for custom materials.

c. Order Confirmation

All orders will be acknowledged.

B. Pricing Policies

1. Terms of Payment

Terms of payment and credit limits will be established based on financial information. Standard payment terms on open credit are net thirty (30) days from invoice date. Advance payments or other payment security may be required by Haworth. The account balance must be at or below the credit limit and current at all times (no past-due balances). Haworth reserves the right to delay or cancel any delivery to a Customer whose Haworth account balance is over the credit limit and/or past due. For walls and floors a deposit will be required.

2. Terms of Credit

Customer hereby authorizes Haworth to obtain such credit reports, financial information or other information as Haworth may request, including, without limitation, credit information from any financial institutions or others having a business relationship with the Customer. Customer hereby authorizes any credit references to answer Haworth's inquiries and provide such credit information and documentation as Haworth may request.

The Customer hereby releases and holds Haworth harmless for any inconvenience whatsoever, caused by any temporary or permanent withdrawal or restriction of credit privileges hereunder, or the enforcement of any of the provisions contained in this paragraph.

3. Past-Due Charges

Past-due balances will be increased by a maximum of 1.5% per month, or 18% annually, without forfeit of Haworth's right to immediate payment.

4. Applicable Prices

The price of any product sold to Customer by Haworth will be based upon the North American Price List (Catalog).

Prices and discounts are subject to change without notice or approval. In the event of an adjustment to pricing, National Sales Agreement (NSA) Customers will be notified in advance according to the terms of the NSA.

Applicable prices and currency exchange rates are those in effect at the time of the RECEIPT of an ORDER; Haworth reserves the right to use the published pricing effective at the time of shipment, if the requested delivery date is more than 120 days after the order receipt date.

North American Terms of Sale

Haworth Flooring products are sold using the North American price list in US dollars. Currency exchange rates at the time of the transaction will be used to convert the USD amount into the alternate currency. Should the currency exchange rate between the USD and alternate currency change between a quote and the receipt of an order, the alternate currency amount will also change to equal the current, equivalent USD amount.

5. C.O.M. (Customer's Own Material) Charges

Refer to appropriate Customer's Own Material (C.O.M.) form for applicable surface material charges.

6. Taxes

Haworth prices do not include customs duty, sales, use, value added or similar taxes. Any federal, state/provincial or other taxes or assessments based upon the sale or delivery of products or services sold applicable to the customer at present or later imposed by federal, state/provincial or municipal agencies, shall be added and paid by the customer. Customer is responsible for all such taxes.

NOTE: For all countries a valid sales tax exemption certificate must be approved by and on file with Haworth prior to product shipment. Otherwise, sales tax will be due and payable to Haworth when such tax is invoiced to Customer.

7. Services

If, as a result of Customer request, the Haworth dealer or Haworth subsidiary provides planning/design services, storage, project management, special handling, set-up, installation and/or other services, the Customer will be charged at the local Haworth dealer/subsidiary's prevailing rates.

8. Termination by Haworth

Haworth may immediately terminate an order upon written notice in the event bankruptcy or insolvency proceedings are instituted by or against the Customer, or the Customer is adjudicated as bankrupt, becomes insolvent, makes an assignment for the benefit of creditors, or proposes or makes any arrangements for the liquidation of its debts, or a receiver or receiver and manager is appointed with respect to all or any part of the assets of the Customer.

C. Shipping and Delivery

Haworth will have the right to determine the method of shipment and routing of product.

This section does not apply to any of Haworth's Flooring products. All Haworth Flooring products are sold freight collect.

If, for any reason, a delivery has to be made to an intermediate location (i.e. a location other than the "Ship To" location noted on the order or ultimate end user location), all handling and re-delivery costs incurred would be at the Customer's expense.

1. U.S.A. - Contiguous

All deliveries will be CPT (Carriage Paid To) (ICC Incoterms 2010) Haworth's manufacturing facilities or distribution centers. Freight charges will be prepaid by Haworth on all orders to locations within the continental United States. Customer bears all risk of loss or damage to the goods when they are placed on Haworth's means of transport.

2. U.S.A. - Non-contiguous (Alaska, Hawaii and Puerto Rico)

All deliveries will be CIF (Cost, Insurance and Freight) (ICC Incoterms 2010). Haworth's catalog prices include ocean freight and insurance to the port of the final destination. Haworth has the right to determine the carrier, method of shipment and routing. Haworth will contract with the insurer and provide minimal insurance coverage (CIF @ 110%) made payable to the Customer. Customer is responsible to obtain greater insurance if so desired.

Customer bears all risk of loss or damage to the goods when the goods are effectively at the disposal of the Customer on board the vessel at the named port of destination. Proof of delivery is a clean on board bill of lading. Customer will be responsible for all on-carriage from the receiving port to the final destination.

3. Canada

All deliveries will be DDP (Delivered Duty Paid) (ICC Incoterms 2010). Haworth's catalog prices include delivery to Customer's named place, not unloaded from any arriving means of transport. Customer bears all risk of loss or damage to the goods when they are delivered to the Customer's named facility not unloaded. Haworth will assume responsibility to file all freight claims with the carrier for any loss/damage which may occur while product is in transit, and will promptly repair or replace any damaged or lost product. Haworth requires the Customer to report all freight damage and/or loss to both the carrier and to Haworth.

NOTE: Under all delivery terms (U.S.A. and Canada), any additional expense resulting from Customer's request for expedited transportation, special services, packaging, handling, routing, and/or shipping method will be billed to Customer.

4. Mexico

All deliveries will be DAP (Delivered to Place) (ICC Incoterms 2010). Haworth's catalog prices include freight charges for normal surface transportation to a United States point of exportation within the 48

contiguous states. Haworth has the right to determine the carrier, method of shipment and routing.

Customer bears all risk of loss or damage to the goods when the goods are delivered to the named United States point of exportation. Haworth will provide customs clearance facilitation and arrangement of local delivery through an Authorized Dealer in Mexico, on a separately negotiated basis. Otherwise the Customer will be responsible for all customs clearance formalities and on-carriage from the United States point of exportation to the final destination in Mexico.

5. Delivery Dates and Delay

If Haworth cannot deliver products as scheduled due to causes beyond its reasonable control (such as casualty, labor disputes, or accident; inability to obtain necessary labor, material or transportation; or changes requested by the Customer), the delivery date will be extended to compensate for the delay as determined by Haworth.

6. Delivery Shortages and Damage

Product shortages and damage must be noted on delivery receipts at the time of delivery and reported to the carrier for correction.

Claims against Haworth for shortages, errors, or damage must be made within ten (10) days of the date of delivery or the Customer waives the right to make such a claim. Signed Bill of Ladings or Delivery Receipt must be sent in with claims. See the Haworth/Haworth Dealers Roles and Responsibilities document for further details.

7. Storage

Haworth may transfer product to storage at the Customer's risk and expense if the Customer is unable or unwilling to take delivery of product as originally scheduled. Upon such transfer to storage, the Customer assumes risk of loss. Haworth will invoice the Customer for storage fees and the Customer will make payments in accordance with Haworth's standard payment terms.

North American Terms of Sale

D. General Terms

1. Governing Law

For products purchased for delivery in the U.S. pursuant hereto, this Agreement shall be governed by and construed according to the laws of the State of Michigan. Where Products are purchased for delivery in Canada pursuant hereto, this Agreement shall be governed by and construed according to the laws of the Province of Alberta. In either case, the parties attorn to the exclusive jurisdiction of the courts of Michigan and Alberta, respectively for the purpose of hearing any disputes arising under this Agreement or with respect to any Products sold pursuant hereto, and agree that the provisions of the United Nations Convention on Contracts for the International Sale of Goods and any other provision or law which would have the effect of applying the laws of any jurisdiction other than Michigan or Alberta, as the case may be, shall be excluded.

2. Force Majeure

In the event that the performance of Customer or Haworth or its participating dealer assignee(s) would be prevented, restricted, interfered with or rendered commercially impracticable by reason of Force Majeure, then upon the giving of notice to the other parties, the party affected by the Force Majeure shall be excused from performing hereunder until the Force Majeure no longer prevents, restricts, interferes with, or renders such performance commercially impracticable.

"Force Majeure" shall mean: fire, explosion, breakdown of plant, epidemic, hailstorm, snow/ice storms en route, hurricane, tornado, cyclone, flood or power failure; war, revolution, civil or military disturbances, acts of public enemies, acts of terrorism, blockade or embargo; any law, order, proclamation, regulation, ordinance, demand or requirement of any applicable governmental authority or any subdivision, authority, or representative of any such government; labor difficulties, including without limitation, strikes, slowdowns, picketing or boycotts; or difficulties beyond Haworth's reasonable control in obtaining necessary raw materials, labor, fuels and electric power, components or facilities, and any other circumstances beyond the control of the party affected.

3. Delays by Customer

Where Haworth has not received adequate site dimensions, Product specifications, shipping information, installation particulars or other information required by Haworth to permit the efficient manufacture of any Products, or where site conditions are not in accordance with the Installation Requirements set forth, or are not otherwise suitable to permit effective and efficient installation, the manufacture and/or delivery of Products may be delayed, and such event shall constitute a delay by the Customer. When manufacture, delivery or installation is delayed by the Customer or at the Customer's request: (i) Haworth may, at its option, present the invoice for the full price of the Products to the Customer as then due and payable; (ii) the Customer shall pay to

Haworth all reasonable storage, handling and other reasonable incidental expenses incurred by Haworth in connection with such delay; and (iii) the Customer shall bear all risk of loss or damage to the Products being held by Haworth for the Customer.

4. Use and Installation of Products

Haworth recommends that its products be installed by certified, qualified and approved installers according to Haworth's written installation procedures. The Customer agrees to use Haworth products properly; not to remove or alter safety devices, warnings, or operation instructions placed on products by Haworth, and to instruct employees as to the proper care and use of the products according to printed instructions.

5. Warranty

Haworth's standard North American Warranty will apply as appropriate. All product line warranty specifics are available in each catalog or upon request.

E. Services

Service requests for design, installation, relocation, storage, etc. are handled by the local Haworth dealer on a separately negotiated basis. Contact the local Haworth dealer, affiliate or area sales office for more details.

Scope of Work - Design

Customer acknowledges that the Products to be manufactured or procured by Haworth in connection with the order are or may be custom manufactured for the Customer and that Haworth may be required to perform extensive work in relation to the design and specification of such Products. Where Customer requests that Haworth create as-built drawings or make more than two material revisions to any particular Product design or specification, Customer agrees that Haworth shall be entitled to invoice Customer with respect to such additional work on the basis of Haworth's then prevailing rates for related design and specification services.

Installation Requirements

Where installation services are to be provided by Haworth, its authorized dealer or subcontractor, a document will be provided setting forth the scope of installation work to be performed (the "Scope of Work") and the price to be charged therefore. Unless otherwise specified in the scope of work, Haworth's installation services are limited to products sold by Haworth with the exception of lighting, under floor electrical and data.

General Conditions

(a) Sufficient time shall be allocated by the Customer following delivery of Products and prior to Customer's occupation of the premises to allow the installation of all Products during conventional working hours, Monday through Friday, 7:30 a.m. to 4:30 p.m. Where sufficient time is not allocated and Haworth is required or requested to perform installation work outside of such times, overtime charges shall be charged at Haworth's then prevailing rates. (b) Haworth shall be given free and exclusive access to; (i) a loading dock within 150' of the freight elevator or hoist, which loading dock shall be of sufficient size to enable full-size tractor-trailer deliveries to the premises (where required by Haworth); (ii) a freight elevator or hoist of sufficient size and capacity to allow the efficient movement of the Products; (iii) an unobstructed and safe pathway to the area where Products are to be stored or staged; (iv) a secure storage / staging area; (v) convenient trash facilities; (vi) adequate lighting; (vii) a work site that complies with applicable health and safety legislation. Where such areas and facilities are not available, Haworth shall be entitled to bill Customer for all amounts incurred by Haworth for double-handling, product movement, lifting, hoisting, trash removal and any other resulting charges. (c) The installation site shall be free and clear of existing furniture, debris, or other obstructions (including construction in progress) and shall otherwise be in the reasonable opinion of Haworth ready for installation of the Products. Any building where Products are to be installed shall be fully closed in, dry and protected from the natural elements, with temperatures between 40°F and 90°F (4°C and 32°C) and relative humidity not to exceed 70% at all times including receipt of products, during and after installation and shall be adequately heated and/or air-conditioned. Where unusual site conditions exist which impede or prevent the normal installation of any Products, applicable extra charges shall apply at prevailing rates. (d) Haworth's installation pricing is based upon the installation occurring as one continuous delivery and installation project. Phased installation pricing shall be provided by Haworth on a case by case basis. (e) Electrical hardwiring, plumbing and mechanical work is not included and shall be the responsibility of the Customer. (f) Except as may be otherwise specifically indicated, installation pricing does not apply to projects where union labor is required. Where Haworth has provided installation pricing on the basis that non-union labor be utilized, and where Haworth is required to use union labor or it otherwise becomes impractical to use non-union labor, or where Haworth is required by law to use prevailing wages, Haworth shall be entitled to charge the Customer for any cost differential between the anticipated cost of non-union labor and the actual cost of utilizing union or prevailing wage labor. (g) Haworth shall not be responsible for obtaining permits.

North American Terms of Sale

Project / Site Conditions

Lateral load bracing is not included in the scope of Haworth's work and shall not be performed by Haworth. In areas where flooring Products are to be installed by Haworth overhead construction must be completed prior to the commencement of such work to avoid damage to the panels and finishes. The existing subfloor must be smooth, mopped clean, free of moisture, dust, dirt and debris. Once installed, the access floor must be maintained in the same manner. The subfloor must have a maximum vertical elevation deviation of 0.375" (10mm) over a horizontal span of 10'-0" (3m), and without discontinuities in floor slope. For greater certainty, the scope of Haworth's installation work in such areas shall not be deemed to include any work required to level such subfloor, remove protrusions, remove pre-existing floor coverings or adhesives, or any other work which is required to remedy any conditions which may impede the efficient installation of flooring. Except as may be otherwise specifically indicated in the order, installation pricing for flooring Products and the Scope of Work in relation thereto shall not include any work required to remove and replace floor panels following their initial installation to provide tradespersons or others with access to the underpanel cable management cavity. In areas where movable walls are to be installed, all flooring (including carpeting) and ceiling components (including dropped ceiling grid components) shall be fully complete and ready for the installation of the movable wall products. Further, the existing floor (or other surface on which the movable wall panels are to be installed) shall have a maximum vertical deviation of 1.25" (30mm) and the dropped ceiling grid shall have a maximum vertical deviation of 0.375" (10mm) from the specifications to which such movable wall panels were designed and manufactured (collectively the "Permitted Tolerances"), and shall otherwise comply with any site condition assumptions made known to Haworth prior to the manufacture of such Products (the "Site Assumptions"). Where the Permitted Tolerances or Site Assumptions are not strictly adhered to or met, additional charges may be incurred in connection with site remediation and/or the modification or remanufacture of affected movable wall products, together with all resulting shipping and labor charges at Haworth's then prevailing rates for such Products and services.

Installation Change Orders

Where Customer requests work to be performed or materials to be provided which are not contemplated in the Scope of Work, or Customer otherwise requests Products or services not contemplated in the order (collectively "Extras"), prior to providing such Extras Haworth reserves the right to require the Customer to provide and sign a written Purchase Order or Change Order acceptable to Haworth describing the Extras and the amounts to be charged therefore, and the Customer agrees to pay such charges.

Entire Agreement

The order and this Agreement (including applicable Schedules) constitute the sole agreement between the parties and supercede any prior understanding or written or oral agreements between the parties (excluding National Sales Agreements). No waiver of any of the provisions of these Standard Terms and Conditions shall be binding on Haworth unless expressly agreed in writing.

Revision Date: June 1, 2015

Index

Products are listed alphabetically in this index by alpha-numeric prefix/suffix codes.

Product Code	Product Description	Page
4043-00	Stacking Chair, Arc Arm, Upholstered Back	280
4045-00	Composites Seating Series – Arc Arm, Upholstered Back	276
4046-00	Composites Seating Series – Repose Arm, Upholstered Back	277
4047-00	Composites Seating Series – Cascade Arm, Upholstered Back	278
4048-00	Composites Seating Series – Contour Arm, Upholstered Back	279
4049-00	Composites Seating Series – Stool, Armless, Upholstered Back	281
4145-00	Composites Seating Series – Arc Arm, Circle Back	276
4146-00	Composites Seating Series – Repose Arm, Hourglass Back	277
4147-00	Composites Seating Series – Cascade Arm, Circle Back	278
4148-00	Composites Seating Series – Contour Arm, Hourglass Back	279
4243-00	Composites Seating Series – Stacking Chair, Arc Arm, Slat Back	280
4245-00	Composites Seating Series – Arc Arm, Slat Back	276
4246-00	Composites Seating Series – Repose Arm, Cross Back	277
4247-00	Composites Seating Series – Cascade Arm, Slat Back	278
4248-00	Composites Seating Series – Contour Arm, Cross Back	279
4249-00	Composites Seating Series – Stool, Armless, Slat Back	281
4851-0011	Hello Seating – Fixed Arm, Metal Legs	304
4851-0011-W	Hello Seating – Fixed Arm, Wood Legs	303
4851-0012	Hello Seating – Fixed Arm, Metal Legs	304
4851-0012-W	Hello Seating – Fixed Arm, Wood Legs	303
4851-0013	Hello Seating – Fixed Arm, Metal Legs	304
4851-0013-W	Hello Seating – Fixed Arm, Wood Legs	303
4852-0011	Hello Seating – Fixed Arm, Metal Legs	305
4852-0012	Hello Seating – Fixed Arm, Metal Legs	305
4852-0013	Hello Seating – Fixed Arm, Metal Legs	305
4854-0011	Hello Seating – Standard Arm	300
4854-0012	Hello Seating –	300
4855-0043	Hello Seating – Standard Arm	301
4855-0043-GSX	Hello Seating –	301
4855-0043-S	Hello Seating –	301
4856-0043	Hello Seating – Mini-mobile	302
4856-0043-A	Hello Seating – Mini-mobile	302
4858-0001	Hello Seating – Accessories	302
4858-0002	Hello Seating – Accessories	302
8181-00	Forenze Seating – Serpentine Arm, Upholstered Back	282
8182-00	Forenze Seating – Curve Arm, Upholstered Back	283
8183-00	Forenze Seating – Scroll Arm, Upholstered Back	284
8184-00	Forenze Seating – Cabriole Arm, Upholstered Back	285
8483-00	Forenze Seating – Scroll Arm, Slat Back	284
8484-00	Forenze Seating – Cabriole Arm, Slat Back	285
D811-2240	Monaco	265
D811-2640	Monaco	266
D821-2240	Monaco	267
D821-2640	Monaco	268
D831-2240	Monaco	269
D831-2640	Monaco	270
D841-2240	Monaco	271

Index

Product Code	Product Description	Page
D841-2640	Monaco	272
F235-2042	Improv Tag	232
F235-2442	Improv Tag	233
F235-2742	Improv Tag	234
F235-2W42	Improv Tag	235
KSCP-5110	Scamps Series – Chair with Arms	314
KSTR-24	Scamps Series – Round Table	314
M211-1042	Improv Series	189
M211-1142	Improv Series	187
M211-1742	Improv Series	188
M221-1042	Improv Series	186
M221-1142	Improv Series	184
M221-1742	Improv Series	185
M231-1042	Improv Series	213
M231-1442	Improv Series	206
M231-1742	Improv Series	208
M231-1H42	Improv Series	210
M231-1W42	Improv Series	212
M235-3042	Improv Series	222
M235-3442	Improv Series	224
M235-3742	Improv Series	226
M235-3H42	Improv Series	228
M235-3W42	Improv Series	230
M251-1042	Improv Series	205
M251-1442	Improv Series	198
M251-1742	Improv Series	200
M251-1H42	Improv Series	202
M251-1W42	Improv Series	204
M271-1042	Improv Series	197
M271-1442	Improv Series	190
M271-1742	Improv Series	192
M271-1H42	Improv Series	194
M2E1-1042	Improv Series	221
M2E1-1442	Improv Series	214
M2E1-1742	Improv Series	216
M2E1-1H42	Improv Series	218
M2E1-1W42	Improv Series	220
M600-2100	Improv Series – Without Arms	237
M600-2110	Improv Series – With Arms	236
M600-2190	Improv Series – With Tablet Arm	238
M600-2300	Improv Series – Without Arms	237
M600-2310	Improv Series – With Arms	236
M600-8100	Improv Series – Without Arms	242
M600-8110	Improv Series – With Arms	242
M600-8300	Improv Series – Without Arms	242
M600-8310	Improv Series – With Arms	242
M601-2100	Improv Series – Without Arms, Non-Stacking	240
M601-2110	Improv Series – With Arms, Non-Stacking	239
M601-2190	Improv Series – Non-Stacking	241

Index

Product Code	Product Description	Page
M601-2300	Improv Series – Without Arms, Non-Stacking	240
M601-2310	Improv Series – With Arms, Non-Stacking	239
MPRV-BARS	Improv Series – Chair-to-Chair Connecting Bars	246
MPRV-CART	Improv Series – Stacking Dolly	243
MPRV-RACK	Improv Series – Book Rack	243
MTE1-20	Improv Series – End-of-Run Table	246
MTI1-20	Improv Series – In-Line Table	246
MTR1-20	Improv Series – Round Table	247
SAS-22-A1A	Candor Modern Seating – Fully Upholstered Seat and Back	275
SAS-22-A1B	Candor Classic Seating – Fully Upholstered Seat and Back	274
SAS-22-A2B	Candor Classic Seating – Fully Upholstered Seat and 3/4 Back	274
SAS-22-A3A	Candor Modern Seating – Fully Upholstered Seat and 1/2 Back	275
SAS-2W-A4A	Candor Modern Seating – Fully Upholstered Seat and Slat Back	275
SAS-2W-A4B	Candor Classic Seating – Fully Upholstered Seat and Slat Back	274
SCB-44-0H	Very – Seminar With Storage Rack	94
SCB-44-3H	Very – Seminar With Storage Rack	94
SCB-45-3H	Very – Seminar With Storage Rack	109
SCC-44-01	Very – Without Arms	97
SCC-44-11	Very – With Arms	96
SCC-45-01	Very – Without Arms	112
SCC-45-11	Very – With Arms	111
SCF-44-01	Very – Without Arms	98
SCF-44-11	Very – Without Arms	98
SCF-45-01	Very – Without Arms	113
SCF-45-11	Very – Without Arms	113
SCH-44-0S	Very – Without Arms	81
SCH-44-3S	Very – With Arms	80
SCHA-R	Very – Wire Stacker Tablet Arm	114
SCHR-1	Very – Wire Stacker Storage Rack	114
SCK-44-3H	Very – Side With Tablet Arm	88
SCK-45-3H	Very – Side With Tablet Arm	103
SCL-44-0H	Very – Side With Tablet Arm	89
SCL-44-3H	Very – Side With Tablet Arm	89
SCL-45-0H	Very – Side With Tablet Arm	104
SCL-45-3H	Very – Side With Tablet Arm	104
SCLC-44-0H	Very – Side With Tablet Arm	90
SCLC-44-3H	Very – Side With Tablet Arm	90
SCLC-45-0H	Very – Side With Tablet Arm	105
SCLC-45-3H	Very – Side With Tablet Arm	105
SCM-44-0H	Very – Without Arms	92
SCM-44-3H	Very – With Arms	91
SCM-44-RH	Very – Seminar With Tablet Arm	93
SCM-45-0H	Very – Without Arms	107
SCM-45-3H	Very – With Arms	106
SCM-45-RH	Very – Seminar With Tablet Arm	108
SCS-44-0H	Very – Without Arms	86
SCS-44-3H	Very – With Arms	85
SCS-44-RH	Very – Side With Tablet Arm	87
SCS-45-0H	Very – Without Arms	101

Index

Product Code	Product Description	Page
SCS-45-3H	Very – With Arms	100
SCS-45-RH	Very – Side With Tablet Arm	102
SCSG-1	Very – Ganging Connector	114
SCSG-2	Very – Ganging Connector	114
SCT-1	Very – Stacking Carts	115
SCT-20-0011	Very Task	130
SCT-20-1011	Very Task	128
SCT-20-4011	Very Task	126
SCT-20-7011	Very Task	124
SCT-20-7115	Very Task Value Model	122
SCT-3	Very – Stacking Carts	115
SCT-4	Very – Stacking Carts	115
SCTC-20-0011	Very Task	138
SCTC-20-1011	Very Task	136
SCTC-20-4011	Very Task	134
SCTC-20-7011	Very Task	132
SCW-44-0S	Very	82
SCW-44-3S	Very	82
SCWC-44-0S	Very	83
SCWC-44-3S	Very	83
SFS-U0-0N02A	Fern – Task Stool without Arms — Aluminum Model	38
SFS-U0-0N02A	Fern – Task Stool without Arms — Plastic Model	37
SFS-U0-1S02A	Fern – Task Stool with Fixed Arms — Aluminum Model	36
SFS-U0-1S02A	Fern – Task Stool with Fixed Arms — Plastic Model	35
SFS-U0-4S02A	Fern – Task Stool with Height Adjustable Arms — Aluminum Model	34
SFS-U0-4S02A	Fern – Task Stool with Height Adjustable Arms — Plastic Model	33
SFS-U0-7S02A	Fern – Task Stool with 4D Arms — Aluminum Model	32
SFS-U0-7S02A	Fern – Task Stool with 4D Arms — Plastic Model	31
SFT-U0-0N02A	Fern – Task Chair without Arms — Aluminum Model	30
SFT-U0-0N02A	Fern – Task Chair without Arms — Plastic Model	29
SFT-U0-1S02A	Fern – Task Chair with Fixed Arms — Aluminum Model	28
SFT-U0-1S02A	Fern – Task Chair with Fixed Arms — Plastic Model	27
SFT-U0-4S02A	Fern – Task Chair with Height Adjustable Arms — Aluminum Model	26
SFT-U0-4S02A	Fern – Task Chair with Height Adjustable Arms — Plastic Model	25
SFT-U0-7S01A5	Fern Value Model – Task Chair with 4D Arms — Plastic Model	22
SFT-U0-7S02A	Fern – Task Chair with 4D Arms — Aluminum Model	24
SFT-U0-7S02A	Fern – Task Chair with 4D Arms — Plastic Model	23
SHL-22-1R10	Harbor Work Lounge – Lounge Chair	296
SHL-22-1R12	Harbor Work Lounge – Lounge Chair	296
SHL-25-1L10	Harbor Work Lounge – Lounge Chair	298
SHL-25-1L12	Harbor Work Lounge – Lounge Chair	298
SHO-22-G	Harbor Work Lounge – Ottoman	297
SHO-25-G	Harbor Work Lounge – Ottoman	299
SLP-22-R	Poppy Lounge – Swivel	294
SLP-22-S	Poppy Lounge – Swivel	294
SLP-22-T	Poppy Lounge – Basket	294
SLS1-2T-01	Lively – Without Arms	153
SLS1-2T-0H	Lively – Without Arms	153
SLS1-2T-11	Lively – With Arms	152

Index

Product Code	Product Description	Page
SLS1-2T-1H	Lively – With Arms	152
SLT1-2T-0115A	Lively – Task Chair without Arms	151
SLT1-2T-1115A	Lively – Task Chair with Fixed Arms	150
SLT1-2T-4115A	Lively – Task Chair with Height Adjustable Arms	149
SLT1-2T-7115A	Lively Value Model – Task Chair with 4D Arms	147
SLT1-2T-7115A	Lively – Task Chair with 4D Arms	148
SODB-2424-P	Openest Collection – Round	289
SODC-1616-P	Openest Collection – Round	289
SON-3	Openest Collection – Plume 3	286
SON-6	Openest Collection – Plume 6	286
SON-9	Openest Collection – Plume 9	286
SOPB-22	Openest Collection – Chick Pouf with Back	288
SOPN-22	Openest Collection – Chick Pouf without Back	288
SORA-5320-P	Openest Collection – Rectangle	289
SOSR-1-RW	Openest Collection – Feather – Asymmetrical	287
SOSS-1-RW	Openest Collection – Feather – Symmetrical	287
SPG-11-4	Poppy – Four Star Base with Glides	292
SPG-11-5	Poppy – Five Star Base with Casters	292
SPG-11-W	Poppy – Wood Base	293
STS-1	Tilt	315
SZG-22-1	Zody – 4 Leg	78
SZG-22-1	Zody – Sled Base	77
SZT-20-002MA1	Zody – Task Chair without Arms	59
SZT-20-102MA1	Zody – Task Chair with Fixed Arms	55
SZT-20-402MA1	Zody – Task Chair with Height Adjustable Arms	51
SZT-20-702MA1	Zody – Task Chair with 4D Arms	47
SZT-20-711MA5	Zody Value Model – Task Chair with 4D Arms	46
SZTC-20-002MA1	Zody – Task Stool without Arms	74
SZTC-20-102MA1	Zody – Task Stool with Fixed Arms	70
SZTC-20-402MA1	Zody – Task Stool with Height Adjustable Arms	66
SZTC-20-702MA1	Zody – Task Stool with 4D Arms	62
TQ84-0011	ToDo	308
TQ84-0012	ToDo	310
TQ84-0013	ToDo	311
TQ85-0011	ToDo	309
TQ90-0001	ToDo – Wood Tablet with Arm	312
TQ90-0003	ToDo – Cup Holder	312
TQ90-0004	ToDo – Grommet Cover	313
TQ90-0006	ToDo – Grommet Cover	312
X611-2040	X99	165
X611-2044	X99	164
X611-2140	X99	163
X611-2144	X99	162
X611-2W40	X99	160
X611-2W44	X99	159
X621-2040	X99	173
X621-2044	X99	172
X621-2140	X99	171
X621-2144	X99	170

Index

<u>Product Code</u>	<u>Product Description</u>	<u>Page</u>
X621-2W40	X99	168
X621-2W44	X99	167
X630-3100	X99	174
X640-0040	X99 – Without Arms	176
X641-2040	X99 – Without Arms	178
X641-2140	X99 – With Arms	177
X840-0140	X99 – With Arms	175
Z600-2100	LOOK Seating – Without Arms	259
Z600-2130	LOOK Seating – With Arms	260
Z600-2210	LOOK Seating – With Arms	260
Z600-2230	LOOK Seating – With Arms	260
Z600-2440	LOOK Seating – Lounge Chair	261
Z831-1042	LOOK Seating	255
Z831-1442	LOOK Seating	256
Z831-1742	LOOK Seating	257
Z831-1W42	LOOK Seating	258
Z851-1042	LOOK Seating	251
Z851-1442	LOOK Seating	252
Z851-1742	LOOK Seating	253
Z851-1W42	LOOK Seating	254

PRODUCT NON-OBSOLESCENCE AND WARRANTY POLICY

This North American Haworth Product Non-Obsolescence and Warranty Policy (the "policy") applies to products manufactured after May 8, 2015. For products manufactured before this date please refer to the policy published in the NA Price List when purchased or contact your local Authorized Haworth Dealer. All Haworth products are warranted for 24 hour / 7 day use over the length of the Applicable Warranty Period as set forth below.

Haworth, Inc. or Haworth, Ltd., (each called "Haworth") will make a good faith effort to maintain product compatibility within our various generations of integrated product platforms to provide our customers with spaces that adapt to change. Under our non-obsolence policy, we commit to provide our customers with products of comparable function or operational characteristics for a term equal to the Applicable Warranty Period. Haworth fabrics and finishes must be updated periodically to maintain the market appeal of our products and respond to the demands and changing preferences of our customers. As a result, we or the manufacturer may discontinue some fabrics and finishes before expiration of the Applicable Warranty Period.

If a new product purchased or leased from Haworth or from an Authorized Haworth Dealer proves to be defective (as defined below) while the product is still in the possession of the initial purchaser or lessee and if they, within the Applicable Warranty Period, inform Haworth of the defect by contacting the local Authorized Haworth Dealer, then, except as provided below, Haworth will, at Haworth's option, either repair or replace the product, at Haworth's expense, or refund the purchase price of the product. Except as provided below, a product shall be considered "defective" if Haworth finds that it is defective in material or workmanship and if the defect materially impairs the use of the product to the purchaser or lessee. The applicable warranty period begins on the day the product is manufactured. If a product that the purchaser or lessee references in a notice of defect was not installed by a Haworth Certified installer and/or reconfigured by a Haworth-trained installer, then the product may not be considered defective and Haworth will not be obligated to repair or replace it or to refund its price.

PRODUCTS / APPLICABLE WARRANTY PERIOD

LIFETIME

All Haworth products are warranted for lifetime *except products, components and materials described below:*

TWELVE YEARS

All Haworth NA manufactured seating is warranted for 24/7 multiple shift use by persons up to 325 lbs and includes the framework, mechanisms, seating foam, seat & back mesh and seating glides & casters.

All wood or wood framed products.

TEN YEARS

All wall products (excluding soft close door mechanisms warranted for Two Years), electrical components (excluding Power Base™ AI, USB receptacles and workware products), electrical accessories, fixed task lighting (excluding LED lighting), adjustable keyboard pads, monitor arms and products that are at any time used in a classroom or educational environment (other than administration areas) *except as limited or described below:*

FIVE YEARS

Fabric scrims and fabrics rated Heavy Duty (A) under the Association of Contract Textiles Guidelines, leather, vertical use markerboard laminates, user-adjustable worksurface mechanisms, gel arm caps, thermofused laminates, slow close mechanisms, LED lighting, Power Base™ receptacles with USB charging outlets, electronic ballasts used in task lighting, horizontal glass or thermoplastic table assemblies and Systems Accessories.

THREE YEARS

Power Base AI Electrical products, workware™ products, Hoop products (excludes any warranty for surface damage such as scratches, dents or abrasions), plastic ultraviolet light color fastness and fabrics rated General Contract (a) under the Association of Contract Textiles Guidelines.

ONE TO FIVE YEARS*

Products that are manufactured outside North America and sold into the North American market.

ONE YEAR

Horizontal use markerboard laminate, Openest™ Plume Screens, soft palm rest, mouse pad insert and translucent edging.

Haworth "Specials" products that involve simple modification of a standard based product will be warranted for the same period as the standard catalog product it is based on. Haworth "Specials" products that deviate from standard catalog product in the form of features, construction, function, or aesthetic will be warranted for 1 year.

All software is without warranty of any kind, either expressed or implied.

All service parts are warranted for two years or the remaining balance of the assembly's original warranty period, whichever is longer.

*The Applicable Warranty Period for each such product is specified in Haworth's price list for the product.

A product will not be considered to be defective, and Haworth will not repair, or replace it or refund its price if the product (1) is a consumable product, such as a lamp; (2) is "Customer's Own Material" (i.e. material specified by the purchaser or lessee that is not a standard Haworth product offering, such as Haworth Alliance fabrics); (3) is not installed and used as recommended in Haworth's written specification, installation, care, maintenance and user guides; (4) has been otherwise misused or suffered abusive damage or (5) is a product that is manufactured by a third-party supplier from whom Haworth purchases it for resale without incorporating it into Haworth product (in which case Haworth will assign to the purchaser or lessee any warranty that the manufacturer provides), unless otherwise specified by Haworth in writing. At all times the Covered Product must have been located in a building that is (i) dry, fully closed-in and protected from the natural elements, and (ii) adequately heated, ventilated and air conditioned in order to maintain an internal temperature between 40°F and 90°F (4°C and 32°C) and relative humidity levels between 25% and 55%.

A defect in material or workmanship does not include damage to a product, or failure of a product to operate or perform properly or to maintain appearance, caused by (a) normal wear and tear; (b) an Act of God or transportation; (c) a product alteration made without Haworth's express written authorization; (d) the natural variation of color, grain or texture found in wood and leather; (e) the natural aging found in materials such as wood, fabric and leather which results in colors shifting during use; (f) dye lot variations in fabric, leather or wall covering (g) the natural patina of leather during use; (h) "puddling" of leather or faux leather; or (i) reverse crocking of dyes from clothing onto our seating materials.

EXCEPT AS STATED ABOVE, HAWORTH DOES NOT MAKE A WARRANTY AS TO ANY PRODUCT AND, IN PARTICULAR, DOES NOT MAKE A WARRANTY OF MERCHANTABILITY OR OF FITNESS FOR A PARTICULAR PURPOSE. Product repair or replacement or refund of the price, at Haworth's option, in accordance with this Policy, is the purchaser's or lessee's exclusive remedy for a product defect. Haworth shall not have tort liability with respect to a product, and Haworth shall not be liable for any consequential, economic, indirect, special, punitive or incidental damages arising from a product defect. Haworth shall not be liable for repair or product placement due to improper installation or any defect in materials used for installation which are not manufactured, sold or supplied by Haworth.

Released May 8, 2015

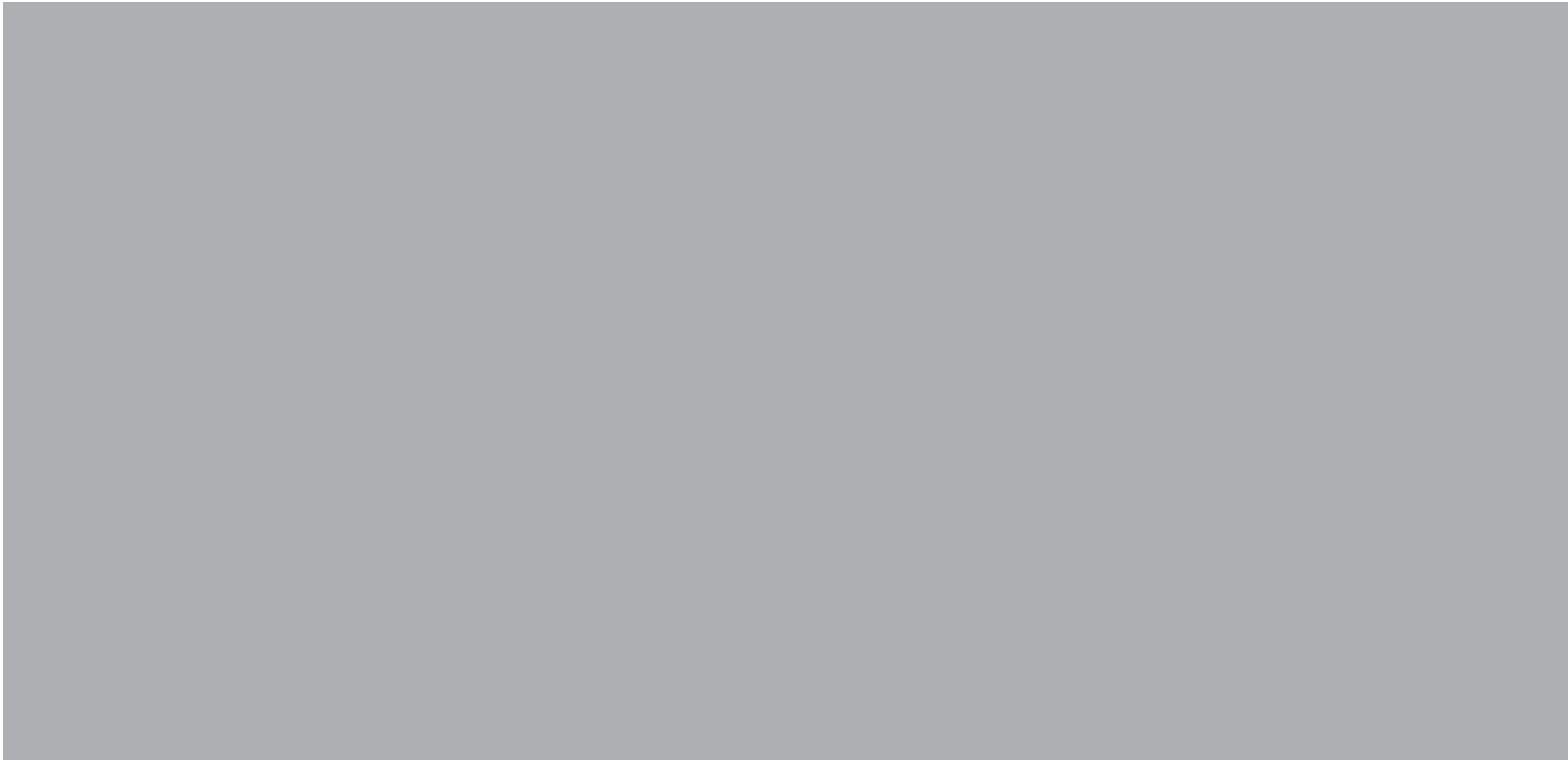

HAWORTH®

For more information call 800.344.2600 or 616.393.3000.

Haworth is a registered trademark of Haworth, Inc.

©Haworth, Inc. 2018 4.18 Item #0004

haworth.com | haworth-europe.com | haworth-asia.com

General Guidelines for Product Specification

	<u>S</u>	<u>J</u>	<u>T</u>	<u>-</u>	<u>2</u>	<u>0</u>	<u>-</u>	<u>7</u>	<u>1</u>	<u>1</u>	<u>A</u>	<u>2</u>	<u>A</u>	<u>3A-18</u>	<u>XT-1</u>	<u>TR-F</u>	<u>TR-LE</u>
Product Type	_____	_____	_____	_____	_____	_____	_____	_____	_____	_____	_____	_____	_____	_____	_____	_____	_____
(S) Seating																	
Product Line	_____	_____	_____	_____	_____	_____	_____	_____	_____	_____	_____	_____	_____	_____	_____	_____	_____
(J) Soji																	
Model (Product Type)	_____	_____	_____	_____	_____	_____	_____	_____	_____	_____	_____	_____	_____	_____	_____	_____	_____
(T) Task																	
Seat Upholstery	_____	_____	_____	_____	_____	_____	_____	_____	_____	_____	_____	_____	_____	_____	_____	_____	_____
(1) Leather																	
(2) Fabric																	
(3) Faux Leather																	
Back Upholstery	_____	_____	_____	_____	_____	_____	_____	_____	_____	_____	_____	_____	_____	_____	_____	_____	_____
(0) Knitted Mesh																	
Arms	_____	_____	_____	_____	_____	_____	_____	_____	_____	_____	_____	_____	_____	_____	_____	_____	_____
(0) No Arms																	
(1) Fixed Arms																	
(4) Height Adjustable Arms																	
(7) 4D Arms																	
Lumbar	_____	_____	_____	_____	_____	_____	_____	_____	_____	_____	_____	_____	_____	_____	_____	_____	_____
(0) No Lumbar																	
(1) Lumbar																	
Back Lock/Forward Tilt	_____	_____	_____	_____	_____	_____	_____	_____	_____	_____	_____	_____	_____	_____	_____	_____	_____
(1) Back Lock																	
(4) Back Lock with Forward Tilt																	
Seat Adjustment	_____	_____	_____	_____	_____	_____	_____	_____	_____	_____	_____	_____	_____	_____	_____	_____	_____
(A) Adjustable																	
(X) Fixed																	
Base	_____	_____	_____	_____	_____	_____	_____	_____	_____	_____	_____	_____	_____	_____	_____	_____	_____
(1) Aluminum Standard Base, Hard Caster																	
(2) Aluminum Standard Base, Soft Caster																	
(3) Aluminum Low Base, Hard Caster																	
(4) Aluminum Low Base, Soft Caster																	
(5) Plastic Standard Base, Hard Caster																	
(6) Plastic Standard Base, Soft Caster																	
(7) Plastic Standard Base, Two-Tone Caster																	
(T) Aluminum Standard Base, Two-Tone Caster																	
Shipping Method	_____	_____	_____	_____	_____	_____	_____	_____	_____	_____	_____	_____	_____	_____	_____	_____	_____
(A) Fully Assembled																	
(K) Knocked Down																	
Seat Upholstery	_____	_____	_____	_____	_____	_____	_____	_____	_____	_____	_____	_____	_____	_____	_____	_____	_____
Tellure																	
Back Upholstery	_____	_____	_____	_____	_____	_____	_____	_____	_____	_____	_____	_____	_____	_____	_____	_____	_____
Knitted Mesh																	
Trim Color (Plastic components)	_____	_____	_____	_____	_____	_____	_____	_____	_____	_____	_____	_____	_____	_____	_____	_____	_____
Black																	
Base Color (Plastic or Aluminum)	_____	_____	_____	_____	_____	_____	_____	_____	_____	_____	_____	_____	_____	_____	_____	_____	_____
Metallic Silver																	

Soji At-A-Glance

General Specifications

Designer	Haworth Design Studio
Soji	
Environmental Factors	BIFMA Level 3 certification pending. GREENGUARD certified for low emissions. Soji is part of the Haworth Take Back Program. Manufactured in a zero landfill, ISO 14001 certified facility in Mississippi, USA.
Finishes and Fabrics	A complete listing of finishes and fabrics for Soji task chairs is available in the back of the price list.
COM & COL General Information	To order a COM fabric (Customer's Own Material) contact the Haworth Inquiry Center (1.800.462.8562), your local Haworth dealer, or go to Surfaces.haworth.com >COM library to find out if the COM you have selected has already been tested and approved. The surface collection site also has information on the Haworth+ alliance program with Carnegie, Luna Textiles, and Maharam as well as our industry-leading Pre-Approved COM program. COM fabrics are placed into Grades based on the cost per linear yard. If a fabric's cost exceeds the range of our highest Grade it will be noted as Non-Graded. The product will be priced at Grade A; the COM fabric costs will appear as a separate line item. The fabric charge will be Haworth's purchase cost plus a 4% administrative fee (based on the cost of the fabric). Yardage calculations will include any applicable fabric repeat. COM Leather products will be priced at a leather Grade A; COL costs will appear as a separate line item. The leather costs will be Haworth's purchase cost plus a 4% administrative fee (based on the cost of the leather).
Stain Repellent	Stain repellent available on fabric seat only. Stain repellent not available on leather or faux leather. To specify add "P" to the end of the product number. Example: SJT-20-711A5A P
Shipping Weights/Cube (Including packaging)	<ul style="list-style-type: none"> • Assembled <ul style="list-style-type: none"> -With arms - 46 lbs. / 16.5 cubic feet -Armless - 41.4 lbs. / 16.5 cubic feet • Knocked Down <ul style="list-style-type: none"> -With arms - XX lbs. / XX cubic feet -Armless - XX lbs. / XX cubic feet <div style="border: 1px solid red; padding: 2px; display: inline-block; margin-top: 10px;">Please supply</div>

Soji At-A-Glance

General Specifications

STANDARD MOBILITY AND ADJUSTABILITY

Seat Height Adjustment

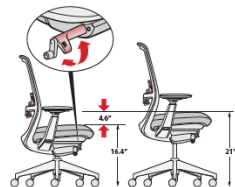
**Features:**

- Pneumatic seat height adjustment.
- Seat height adjusts 4.6"(117mm) from 16.4" to 21.0"(417mm-533mm) on standard models. Low-position adjusts from 14.75" to 17.5"(375mm-445mm).

Benefits:

- Ensures the comfort of the lower limbs by avoiding pressure on the underside of the thigh caused by a seat pan that is too high, or decreased thigh-to-torso angle if the seat is too low.
- Seat height adjustment is important in setting the proper hand position and allowing for proper sitting eye height as well.

Seat Depth Adjustment

**Feature:**

- Optional seat depth has 2.5"(64mm) seat depth range. Fixed seat also available.

Benefit:

- Supports the thighs, allows users to rest against the seat back for back support, and avoids pressure on the back of the knees of small to tall users.

Synchronous Tilt Mechanism

**Features:**

- Back reclines 23° from the upright position.
- 2:1 recline ratio.

Benefits:

- Comfortable relaxed posture.
- Recline allows for the opening of the user's chest cavity providing good airflow to promote alertness.
- User's feet remain flat on the floor.

Tilt Tension Control

**Feature:**

- Regulates the amount of resistance felt when leaning back in the chair and the effort required to recline the chair backwards.

Benefit:

- Personalized support to accommodate users of different body types and different work styles.

Forward Tilt

**Feature:**

- Optional forward tilt allows seat pan to move downward **5° downward** from the initial position.

Benefit:

- Allows user the opportunity to vary their posture throughout the day.

Back Lock

**Feature:**

- Single position back lock.

Benefit:

- Allows users to lock the back of the chair in the upright position for tasking applications.

Lumbar Support

**Features:**

- Optional height adjustable lumbar.
- Range of 3.5"(89mm) of height adjustment.
- Available in Black or Fog. Lumbar will be black if Carbon knitted mesh is ordered or plastic trim color is black. Lumbar will be Fog if plastic trim is specified as Fog or Snow and mesh is not Carbon.

Benefits:

- Provides additional support in the lower back.
- Lumbar adjustment maintains the natural curvature of the spine at the lower back and allows the user to position the support to where it is most comfortable.

Soji At-A-Glance

General Specifications

STANDARD MOBILITY AND ADJUSTABILITY

4D Arm

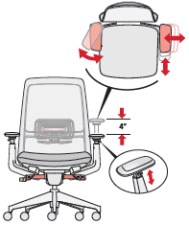
**Features:**

- Optional 4D arm adjusts in 4 ways:
 - Height adjustment 4”(102mm)
 - Side-to-side arm cap adjustment range: 3”(76mm) [1.5”(38mm) each arm cap]
 - Front-to back adjustment range: 3.5”(89mm)
 - Pivoting 20° in and 20° out

Benefits:

- Arms support the muscular system of user’s neck and shoulders; proper arm support provides back relief.
- Arms can be an aid in standing or sitting down.
- Height adjustment accommodates for users with varying elbow rest heights so that users avoid lifting their shoulders or leaning sideways to get arm support.
- Front-to-back adjustment adjusts the armrest length, which is important because it allows users to get close to the worksurface while maintaining the effective use of the backrest.
- Side-to-side adjustment ensures a comfortable resting position for the arms with proper support of the forearm while allowing for easy entry/exit of the chair.
- Pivoting provides proper support of the forearm when performing tasks involving keying and mousing.

Height Adjustable Arm

Feature:

- Optional height adjustable arms adjust 4”(102mm) vertically.

Benefit:

- Height adjustment accommodates users with varying elbow rest heights so that users avoid lifting their shoulders or leaning sideways to get arm support.

Base

Standard Plastic Base

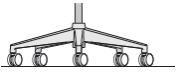
**Colors:**

Fog, Black

Casters:

Hard: Black or Two-Tone Grey
Soft: Black

Aluminum Base

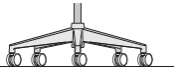
**Colors:**

Painted Black or Metallic Silver or Polished aluminum

Casters:

Hard: Black or Two-Tone Grey
Soft: Black

Low Position Base (Aluminum only)

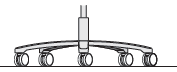
**Colors:**

Painted Black or Metallic Silver

Casters:

Hard: Black
Soft: Black

Leather Upholstery

**Features:**

- Available on seat only.
- Stitched double seams vertically in the center and on the edges of the seat cushion.

Soji At-A-Glance

General Specifications
Upholstery / Aesthetic Options

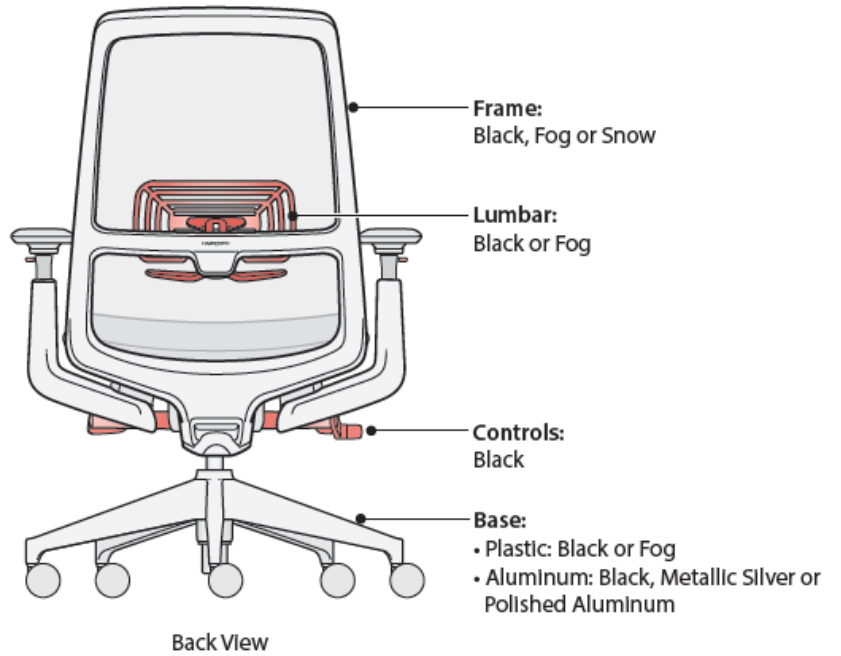
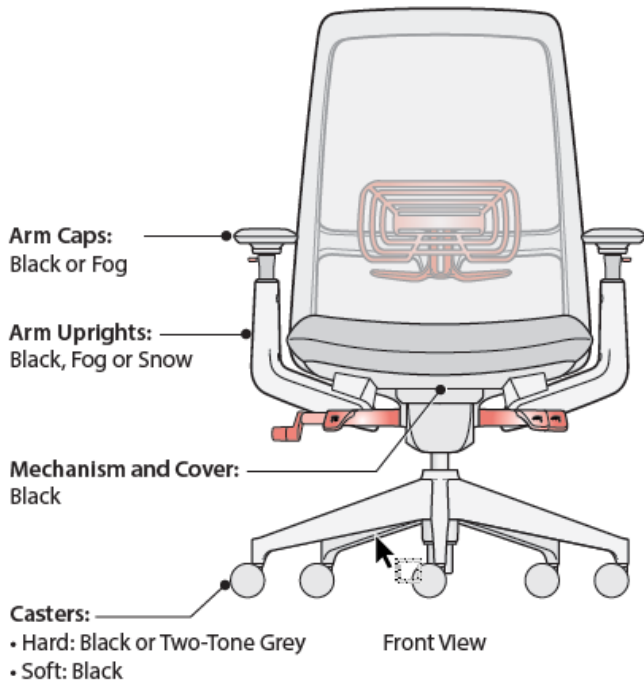



SJT-20-711A

Dimensions

- *SH: 16.4"-21.0"
(417mm-533mm)
H: 39"-44"
(991mm-1118mm)
D: 27"(686mm)
W: 28"(711mm)
*SW: 20"(508mm)
*AH: 7.4"-11.4"
(188mm-290mm)
*SD: 16.25"-18.75"
(413mm-476mm)

* All measurements taken with the BIFMA chair measuring device.

Features

- Back: Knitted mesh.
- Seat: Standard upholstered foam covered in leather, fabric or faux leather. Available as a fixed seat or with seat depth adjustment (2.5"(64mm) range).
- Base: Plastic five-star base.
- Arms: 4D arms have height adjustment range of 4"(102mm). Arms move front to back, side to side and pivot in and out.
- Lumbar: Available with optional lumbar support with 3.5"(89mm) adjustment.
- Mechanism: Synchronized tilt; standard tilt tension adjustment.
- Height adjustment: Standard pneumatic.
- Back Lock: Standard single position upright back lock.
- Optional Forward Tilt: 5° downward from initial position. Only available on chairs with seat depth adjustment.
- Casters: Hard casters in black or two-tone grey; Soft casters black only.
- COM yardage/COL square footage: (Seat only) 0.62/5.6
- Ships standard assembled. Optional knocked down shipment comes in three pieces; assembly does not require tools.

To Order, Specify:

- 1) Product number, including;

1 Seat Upholstery:

- 1 Leather
2 Fabric
3 Faux Leather

2 Caster Option:

- 5 Hard Casters (Black)
6 Soft Casters (Black)
7 Hard Two-Tone Casters (Grey)

- 2) Seat surface material and color.
3) Back surface material and color.
4) Plastic trim color.
TR-F Black
TR-7 Fog, add **\$65.00** list.
TR-UFM Snow, add **\$105.00** list.
5) Base color.
TR-F Black
TR-7 Fog

Specification Tip

- Lumbar color defaults based on chair attributes and is available in Black or Fog only.
 - Black will be received if Carbon knitted mesh is ordered or plastic trim color is Black.
 - Fog will be received if Fog or Snow plastic trim is ordered and knitted mesh is not Carbon.

Description	Number		Fabric Grade							Leather Grade A	Leather Grade B		
	1	2	A	B	C	D	E	F	G			H	
Mesh Back, No Lumbar Adjustment													
Back Lock w/Fixed Seat	SJT-	0-701X	A	\$685.00	\$716.49	\$750.24	\$766.00	\$779.48	\$808.74	\$835.73	\$ 907.73	\$ 971.84	\$1112.45
Back Lock w/Seat Depth Adjustment	SJT-	0-701A	A	716.00	747.49	781.24	797.00	810.48	839.74	866.73	938.73	1002.84	1143.45
Back Lock & Forward Tilt w/Seat Depth Adjustment	SJT-	0-704A	A	751.00	782.49	816.24	832.00	845.48	874.74	901.73	973.73	1037.84	1178.45
Mesh Back, Lumbar Adjustment													
Back Lock w/Fixed Seat	SJT-	0-711X	A	\$733.00	\$764.49	\$798.24	\$814.00	\$827.48	\$856.74	\$883.73	\$ 955.73	\$1019.84	\$1160.45
Back Lock w/Seat Depth Adjustment	SJT-	0-711A	A	764.00	795.49	829.24	845.00	858.48	887.74	914.73	986.73	1050.84	1191.45
Back Lock & Forward Tilt w/Seat Depth Adjustment	SJT-	0-714A	A	799.00	830.49	864.24	880.00	893.48	922.74	949.73	1021.73	1085.84	1226.45

The following options require modification of the product number.

- Knocked Down Shipment To specify, change the 11th digit from an **A** to **K** and deduct **\$30.00** list; **Example:** SJT-20-701X5K
Stain Repellent (Fabric seat only) To specify, add **P** to the end of the product number and add **\$35.00** list; **Example:** SJT-20-701X5AP

Soji

Task Chair with 4D Arms — Aluminum Base



SJT-20-711A

Dimensions

- *SH: 16.4"-21.0"
(417mm-533mm)
- H: 39"-44"
(991mm-1118mm)
- D: 27"(686mm)
- W: 28"(711mm)
- *SW: 20"(508mm)
- *AH: 7.4"-11.4"
(188mm-290mm)
- *SD: 16.25"-18.75"
(413mm-476mm)

Low position seat height:
14.75"-17.5"
(375mm-445mm)

* All measurements taken with the BIFMA chair measuring device.

Features

- Back: Knitted mesh.
- Seat: Standard upholstered foam covered in leather, fabric or faux leather. Available as a fixed seat or with seat depth adjustment (2.5"(64mm) range).
- Base: Aluminum five-star base.
- Arms: 4D arms have height adjustment range of 4"(102mm). Arms move front to back, side to side and pivot in and out.
- Lumbar: Available with optional lumbar support with 3.5"(89mm) adjustment.
- Mechanism: Synchronized tilt; standard tilt tension adjustment.
- Height adjustment: Standard pneumatic.
- Back Lock: Standard single position upright back lock.
- Optional Forward Tilt: 5° downward from initial position. Only available on chairs with seat depth adjustment.
- Casters: Hard casters in black or two-tone grey; Soft casters black only.
- COM yardage/COL square footage: (Seat only) 0.62/5.6
- Ships standard assembled. Optional knocked down shipment comes in three pieces; assembly does not require tools.

Specification Tip

- Lumbar color defaults based on chair attributes and is available in Black or Fog only.
 - Black will be received if Carbon knitted mesh is ordered or plastic trim color is Black.
 - Fog will be received if Fog or Snow plastic trim is ordered and knitted mesh is not Carbon.

To Order, Specify:

1) Product number, including;

1 Seat Upholstery:

- 1 Leather
- 2 Fabric
- 3 Faux Leather

2 Caster Option: Standard Base

- 1 Std. Base Hard Casters (Black)
- 2 Std. Base Soft Casters (Black)
- T Std. Base Hard Two-Tone Casters (Grey)

Low Base

- 3 Low Base, Hard Casters (Black)
- 4 Low Base, Soft Casters (Black)

2) Seat surface material and color.

3) Back surface material and color.

4) Plastic trim color.
TR-F Black
TR-7 Fog, add **\$65.00** list.
TR-UFM Snow, add **\$105.00** list.

5) Base color.
TR-F Black
TR-LE Metallic Silver
PM-P Polished Aluminum, add **\$187.47** list.

Description	Number		Fabric Grade							Leather Grade A	Leather Grade B		
	1	2	A	B	C	D	E	F	G			H	
Mesh Back, No Lumbar Adjustment													
Back Lock w/Fixed Seat	SJT-	0-701X	A	\$747.14	\$778.63	\$812.38	\$828.14	\$841.62	\$870.88	\$ 897.87	\$ 969.87	\$1033.98	\$1174.59
Back Lock w/Seat Depth Adjustment	SJT-	0-701A	A	778.14	809.63	843.38	859.14	872.62	901.88	928.87	1000.87	1064.98	1205.59
Back Lock & Forward Tilt w/Seat Depth Adjustment	SJT-	0-704A	A	813.14	844.63	878.38	894.14	907.62	936.88	963.87	1035.87	1099.98	1240.59
Mesh Back, Lumbar Adjustment													
Back Lock w/Fixed Seat	SJT-	0-711X	A	\$795.14	\$826.63	\$860.38	\$876.14	\$889.62	\$918.88	\$ 945.87	\$1017.87	\$1081.98	\$1222.59
Back Lock w/Seat Depth Adjustment	SJT-	0-711A	A	826.14	857.63	891.38	907.14	920.62	949.88	976.87	1048.87	1112.98	1253.59
Back Lock & Forward Tilt w/Seat Depth Adjustment	SJT-	0-714A	A	861.14	892.63	926.38	942.14	955.62	984.88	1011.87	1083.87	1147.98	1288.59

The following options require modification of the product number.

- Knocked Down Shipment To specify, change the 11th digit from an **A** to **K** and deduct **\$30.00** list; **Example:** SJT-20-701X1K
- Stain Repellent (Fabric seat only) To specify, add **P** to the end of the product number and add **\$35.00** list; **Example:** SJT-20-701X1AP



SJT-20-401X

Dimensions

- *SH: 16.4"-21.0"
(417mm-533mm)
- H: 39"-44"
(991mm-1118mm)
- D: 27"(686mm)
- W: 28"(711mm)
- *SW: 20"(508mm)
- *AH: 7.4"-11.4"
(188mm-290mm)
- *SD: 16.25"-18.75"
(413mm-476mm)

* All measurements taken with the BIFMA chair measuring device.

Features

- Back: Knitted mesh.
- Seat: Standard upholstered foam covered in leather, fabric or faux leather. Available as a fixed seat or with seat depth adjustment (2.5"(64mm) range).
- Base: Plastic five-star base.
- Arms: Height adjustable with 4"(102mm) range.
- Lumbar: Available with optional lumbar support with 3.5"(89mm) adjustment.
- Mechanism: Synchronized tilt; standard tilt tension adjustment.
- Height adjustment: Standard pneumatic.
- Back Lock: Standard single position upright back lock.
- Optional Forward Tilt: 5° downward from initial position. Only available on chairs with seat depth adjustment.
- Casters: Hard casters in black or two-tone grey; Soft casters black only.
- COM yardage/COL square footage: (Seat only) 0.62/5.6
- Ships standard assembled. Optional knocked down shipment comes in three pieces; assembly does not require tools.

To Order, Specify:

- 1) Product number, including;

1 Seat Upholstery:

- 1 Leather
- 2 Fabric
- 3 Faux Leather

2 Caster Option:

- 5 Hard Casters (Black)
- 6 Soft Casters (Black)
- 7 Hard Two-Tone Casters (Grey)

- 2) Seat surface material and color.
- 3) Back surface material and color.
- 4) Plastic trim color.
TR-F Black
TR-7 Fog, add **\$65.00** list.
TR-UFM Snow, add **\$105.00** list.
- 5) Base color.
TR-F Black
TR-7 Fog

Specification Tip

- Lumbar color defaults based on chair attributes and is available in Black or Fog only.
 - Black will be received if Carbon knitted mesh is ordered or plastic trim color is Black.
 - Fog will be received if Fog or Snow plastic trim is ordered and knitted mesh is not Carbon.

Description	Number		Fabric Grade								Leather Grade A	Leather Grade B	
	1	2	A	B	C	D	E	F	G	H			
Mesh Back, No Lumbar Adjustment													
Back Lock w/Fixed Seat	SJT-	0-401X	A	\$671.00	\$702.49	\$736.24	\$752.00	\$765.48	\$794.74	\$821.73	\$ 893.73	\$ 957.84	\$1098.45
Back Lock w/Seat Depth Adjustment	SJT-	0-401A	A	702.00	733.49	767.24	783.00	796.48	825.74	852.73	924.73	988.84	1129.45
Back Lock & Forward Tilt w/Seat Depth Adjustment	SJT-	0-404A	A	737.00	768.49	802.24	818.00	831.48	860.74	887.73	959.73	1023.84	1164.45
Mesh Back, Lumbar Adjustment													
Back Lock w/Fixed Seat	SJT-	0-411X	A	\$719.00	\$750.49	\$784.24	\$800.00	\$813.48	\$842.74	\$869.73	\$ 941.73	\$1005.84	\$1146.45
Back Lock w/Seat Depth Adjustment	SJT-	0-411A	A	750.00	781.49	815.24	831.00	844.48	873.74	900.73	972.73	1036.84	1177.45
Back Lock & Forward Tilt w/Seat Depth Adjustment	SJT-	0-414A	A	785.00	816.49	850.24	866.00	879.48	908.74	935.73	1007.73	1071.84	1212.45

The following options require modification of the product number.

- Knocked Down Shipment To specify, change the 11th digit from an **A** to **K** and deduct **\$30.00** list; **Example:** SJT-20-401X5K
- Stain Repellent (Fabric seat only) To specify, add **P** to the end of the product number and add **\$35.00** list; **Example:** SJT-20-401X5AP

Soji

Task Chair with Height Adjustable Arms — Aluminum Base



SJT-20-411X

Dimensions

- *SH: 16.4"-21.0"
(417mm-533mm)
- H: 39"-44"
(991mm-1118mm)
- D: 27"(686mm)
- W: 28"(711mm)
- *SW: 20"(508mm)
- *AH: 7.4"-11.4"
(188mm-290mm)
- *SD: 16.25"-18.75"
(413mm-476mm)

Low position seat height:
14.75"-17.5"
(375mm-445mm)

* All measurements taken with the BIFMA chair measuring device.

Features

- Back: Knitted mesh.
- Seat: Standard upholstered foam covered in leather, fabric or faux leather. Available as a fixed seat or with seat depth adjustment (2.5"(64mm) range).
- Base: Aluminum five-star base.
- Arms: Height adjustable with 4"(102mm) range.
- Lumbar: Available with optional lumbar support with 3.5"(89mm) adjustment.
- Mechanism: Synchronized tilt; standard tilt tension adjustment.
- Height adjustment: Standard pneumatic.
- Back Lock: Standard single position upright back lock.
- Optional Forward Tilt: 5° downward from initial position. Only available on chairs with seat depth adjustment.
- Casters: Hard casters in black or two-tone grey; Soft casters black only.
- COM yardage/COL square footage: (Seat only) 0.62/5.6
- Ships standard assembled. Optional knocked down shipment comes in three pieces; assembly does not require tools.

Specification Tip

- Lumbar color defaults based on chair attributes and is available in Black or Fog only.
 - Black will be received if Carbon knitted mesh is ordered or plastic trim color is Black.
 - Fog will be received if Fog or Snow plastic trim is ordered and knitted mesh is not Carbon.

To Order, Specify:

1) Product number, including;

1 Seat Upholstery:

- 1 Leather
- 2 Fabric
- 3 Faux Leather

2 Caster Option: Standard Base

- 1 Std. Base Hard Casters (Black)
- 2 Std. Base Soft Casters (Black)
- T Std. Base Hard Two-Tone Casters (Grey)

Low Base

- 3 Low Base, Hard Casters (Black)
- 4 Low Base, Soft Casters (Black)

2) Seat surface material and color.
3) Back surface material and color.

4) Plastic trim color.
TR-F Black
TR-7 Fog, add **\$65.00** list.
TR-UFM Snow, add **\$105.00** list.

5) Base color.
TR-F Black
TR-LE Metallic Silver
PM-P Polished Aluminum, add **\$187.47** list.

Description	Number	1	2	Fabric Grade							Leather Grade A	Leather Grade B	
				A	B	C	D	E	F	G			H
Mesh Back, No Lumbar Adjustment													
Back Lock w/Fixed Seat	SJT-	0-401X	A	\$733.14	\$764.63	\$798.38	\$814.14	\$827.62	\$856.88	\$883.87	\$ 955.87	\$1019.98	\$1160.59
Back Lock w/Seat Depth Adjustment	SJT-	0-401A	A	764.14	795.63	829.38	845.14	858.62	887.88	914.87	986.87	1050.98	1191.59
Back Lock & Forward Tilt w/Seat Depth Adjustment	SJT-	0-404A	A	799.14	830.63	864.38	880.14	893.62	922.88	949.87	1021.87	1085.98	1226.59
Mesh Back, Lumbar Adjustment													
Back Lock w/Fixed Seat	SJT-	0-411X	A	\$781.14	\$812.63	\$846.38	\$862.14	\$875.62	\$904.88	\$931.87	\$1003.87	\$1067.98	\$1208.59
Back Lock w/Seat Depth Adjustment	SJT-	0-411A	A	812.14	843.63	877.38	893.14	906.62	935.88	962.87	1034.87	1098.98	1239.59
Back Lock & Forward Tilt w/Seat Depth Adjustment	SJT-	0-414A	A	847.14	878.63	912.38	928.14	941.62	970.88	997.87	1069.87	1133.98	1274.59

The following options require modification of the product number.

- Knocked Down Shipment To specify, change the 11th digit from an **A** to **K** and deduct **\$30.00** list; **Example:** SJT-20-401X1K
- Stain Repellent (Fabric seat only) To specify, add **P** to the end of the product number and add **\$35.00** list; **Example:** SJT-20-401X1AP



SJT-20-111A

Dimensions

- *SH: 16.4"-21.0"
(417mm-533mm)
- H: 39"-44"
(991mm-1118mm)
- D: 27"(686mm)
- W: 28"(711mm)
- *SW: 20"(508mm)
- *AH: 9"(229mm)
- *SD: 16.25"-18.75"
(413mm-476mm)

* All measurements taken with the BIFMA chair measuring device.

Features

- Back: Knitted mesh.
- Seat: Standard upholstered foam covered in leather, fabric or faux leather. Available as a fixed seat or with seat depth adjustment (2.5"(64mm) range).
- Base: Plastic five-star base.
- Arms: Fixed height.
- Lumbar: Available with optional lumbar support with 3.5"(89mm) adjustment.
- Mechanism: Synchronized tilt; standard tilt tension adjustment.
- Height adjustment: Standard pneumatic.
- Back Lock: Standard single position upright back lock.
- Optional Forward Tilt: 5° downward from initial position. Only available on chairs with seat depth adjustment.
- Casters: Hard casters in black or two-tone grey; Soft casters black only.
- COM yardage/COL square footage: (Seat only) 0.62/5.6
- Ships standard assembled. Optional knocked down shipment comes in three pieces; assembly does not require tools.

To Order, Specify:

1) Product number, including;

1 Seat Upholstery:

- 1 Leather
- 2 Fabric
- 3 Faux Leather

2 Caster Option:

- 5 Hard Casters (Black)
- 6 Soft Casters (Black)
- 7 Hard Two-Tone Casters (Grey)

- 2) Seat surface material and color.
- 3) Back surface material and color.
- 4) Plastic trim color.
TR-F Black
TR-7 Fog, add **\$65.00** list.
TR-UFM Snow, add **\$105.00** list.
- 5) Base color.
TR-F Black
TR-7 Fog

Specification Tip

- Lumbar color defaults based on chair attributes and is available in Black or Fog only.
–Black will be received if Carbon knitted mesh is ordered or plastic trim color is Black.
–Fog will be received if Fog or Snow plastic trim is ordered and knitted mesh is not Carbon.

Description	Number		Fabric Grade								Leather Grade A	Leather Grade B	
	1	2	A	B	C	D	E	F	G	H			
Mesh Back, No Lumbar Adjustment													
Back Lock w/Fixed Seat	SJT-	0-101X	A	\$624.00	\$655.49	\$689.24	\$705.00	\$718.48	\$747.74	\$774.73	\$846.73	\$ 910.84	\$1051.45
Back Lock w/Seat Depth Adjustment	SJT-	0-101A	A	655.00	686.49	720.24	736.00	749.48	778.74	805.73	877.73	941.84	1082.45
Back Lock & Forward Tilt w/Seat Depth Adjustment	SJT-	0-104A	A	690.00	721.49	755.24	771.00	784.48	813.74	840.73	912.73	976.84	1117.45
Mesh Back, Lumbar Adjustment													
Back Lock w/Fixed Seat	SJT-	0-111X	A	\$672.00	\$703.49	\$737.24	\$753.00	\$766.48	\$795.74	\$822.73	\$894.73	\$ 958.84	\$1099.45
Back Lock w/Seat Depth Adjustment	SJT-	0-111A	A	703.00	734.49	768.24	784.00	797.48	826.74	853.73	925.73	989.84	1130.45
Back Lock & Forward Tilt w/Seat Depth Adjustment	SJT-	0-114A	A	738.00	769.49	803.24	819.00	832.48	861.74	888.73	960.73	1024.84	1165.45

The following options require modification of the product number.

- Knocked Down Shipment To specify, change the 11th digit from an **A** to **K** and deduct **\$30.00** list; **Example:** SJT-20-101X5K
- Stain Repellent (Fabric seat only) To specify, add **P** to the end of the product number and add **\$35.00** list; **Example:** SJT-20-101X5AP

Soji

Task Chair with Fixed Arms — Aluminum Base



SJT-20-111A

Dimensions

- *SH: 16.4"-21.0"
(417mm-533mm)
- H: 39"-44"
(991mm-1118mm)
- D: 27"(686mm)
- W: 28"(711mm)
- *SW: 20"(508mm)
- *AH: 9"(229mm)
- *SD: 16.25"-18.75"
(413mm-476mm)

Low position seat height:
14.75"-17.5"
(375mm-445mm)

* All measurements taken with the BIFMA chair measuring device.

Features

- Back: Knitted mesh.
- Seat: Standard upholstered foam covered in leather, fabric or faux leather. Available as a fixed seat or with seat depth adjustment (3"(76mm) range).
- Base: Aluminum five-star base.
- Arms: Fixed height.
- Lumbar: Available with optional lumbar support with 3.5"(89mm) adjustment.
- Mechanism: Synchronized tilt; standard tilt tension adjustment.
- Height adjustment: Standard pneumatic.
- Back Lock: Standard single position upright back lock.
- Optional Forward Tilt: 5° downward from initial position. Only available on chairs with seat depth adjustment.
- Casters: Hard casters in black or two-tone grey; Soft casters black only.
- COM yardage/COL square footage: (Seat only) 0.62/5.6
- Ships standard assembled. Optional knocked down shipment comes in three pieces; assembly does not require tools.

Specification Tip

- Lumbar color defaults based on chair attributes and is available in Black or Fog only.
 - Black will be received if Carbon knitted mesh is ordered or plastic trim color is Black.
 - Fog will be received if Fog or Snow plastic trim is ordered and knitted mesh is not Carbon.

To Order, Specify:

1) Product number, including;

1 Seat Upholstery:

- 1 Leather
- 2 Fabric
- 3 Faux Leather

2 Caster Option: Standard Base

- 1 Std. Base Hard Casters (Black)
- 2 Std. Base Soft Casters (Black)
- T Std. Base Hard Two-Tone Casters (Grey)

Low Base

- 3 Low Base, Hard Casters (Black)
- 4 Low Base, Soft Casters (Black)

2) Seat surface material and color.
3) Back surface material and color.

4) Plastic trim color.
TR-F Black
TR-7 Fog, add **\$65.00** list.
TR-UFM Snow, add **\$105.00** list.

5) Base color.
TR-F Black
TR-LE Metallic Silver
PM-P Polished Aluminum, add **\$187.47** list.

Description	Number		Fabric Grade						Leather Grade A	Leather Grade B			
	1	2	A	B	C	D	E	F			G	H	
Mesh Back, No Lumbar Adjustment													
Back Lock w/Fixed Seat	SJT-	0-101X	A	\$686.14	\$717.63	\$751.38	\$767.14	\$780.62	\$809.88	\$836.87	\$ 908.87	\$ 972.98	\$1113.59
Back Lock w/Seat Depth Adjustment	SJT-	0-101A	A	717.14	748.63	782.38	798.14	811.62	840.88	867.87	939.87	1003.98	1144.59
Back Lock & Forward Tilt w/Seat Depth Adjustment	SJT-	0-104A	A	752.14	783.63	817.38	833.14	846.62	875.88	902.87	974.87	1038.98	1179.59
Mesh Back, Lumbar Adjustment													
Back Lock w/Fixed Seat	SJT-	0-111X	A	\$734.14	\$765.63	\$799.38	\$815.14	\$828.62	\$857.88	\$884.87	\$ 956.87	\$1020.98	\$1161.59
Back Lock w/Seat Depth Adjustment	SJT-	0-111A	A	765.14	796.63	830.38	846.14	859.62	888.88	915.87	987.87	1051.98	1192.59
Back Lock & Forward Tilt w/Seat Depth Adjustment	SJT-	0-114A	A	800.14	831.63	865.38	881.14	894.62	923.88	950.87	1022.87	1086.98	1227.59

The following options require modification of the product number.

- Knocked Down Shipment To specify, change the 11th digit from an **A** to **K** and deduct **\$30.00** list; **Example:** SJT-20-101X1K
- Stain Repellent (Fabric seat only) To specify, add **P** to the end of the product number and add **\$35.00** list; **Example:** SJT-20-101X1AP



SJT-20-011A

Dimensions

- *SH: 16.4"-21.0"
(417mm-533mm)
- H: 39"-44"
(991mm-1118mm)
- D: 27"(686mm)
- W: 28"(711mm)
- *SW: 20"(508mm)
- *SD: 16.25"-18.75"
(413mm-476mm)

* All measurements taken with the BIFMA chair measuring device.

Features

- Back: Knitted mesh.
- Seat: Standard upholstered foam covered in leather, fabric or faux leather. Available as a fixed seat or with seat depth adjustment (2.5"(64mm) range).
- Base: Plastic five-star base.
- Lumbar: Available with optional lumbar support with 3.5"(89mm) adjustment.
- Mechanism: Synchronized tilt; standard tilt tension adjustment.
- Height adjustment: Standard pneumatic.
- Back Lock: Standard single position upright back lock.
- Optional Forward Tilt: 5° downward from initial position. Only available on chairs with seat depth adjustment.
- Casters: Hard casters in black or two-tone grey; Soft casters black only.
- COM yardage/COL square footage: (Seat only) 0.62/5.6
- Ships standard assembled. Optional knocked down shipment comes in three pieces; assembly does not require tools.

To Order, Specify:

1) Product number, including;

1 Seat Upholstery:

- 1 Leather
- 2 Fabric
- 3 Faux Leather

2 Caster Option:

- 5 Hard Casters (Black)
- 6 Soft Casters (Black)
- 7 Hard Two-Tone Casters (Grey)

- 2) Seat surface material and color.
- 3) Back surface material and color.
- 4) Plastic trim color.
TR-F Black
TR-7 Fog, add **\$65.00** list.
TR-UFM Snow, add **\$105.00** list.
- 5) Base color.
TR-F Black
TR-7 Fog

Specification Tip

- Lumbar color defaults based on chair attributes and is available in Black or Fog only.
-Black will be received if Carbon knitted mesh is ordered or plastic trim color is Black.
-Fog will be received if Fog or Snow plastic trim is ordered and knitted mesh is not Carbon.

Description	Number		Fabric Grade								Leather Grade A	Leather Grade B	
	1	2	A	B	C	D	E	F	G	H			
Mesh Back, No Lumbar Adjustment													
Back Lock w/Fixed Seat	SJT-	0-001X	A	\$572.00	\$603.49	\$637.24	\$653.00	\$666.48	\$695.74	\$722.73	\$794.73	\$858.84	\$ 999.45
Back Lock w/Seat Depth Adjustment	SJT-	0-001A	A	603.00	634.49	668.24	684.00	697.48	726.74	753.73	825.73	889.84	1030.45
Back Lock & Forward Tilt w/Seat Depth Adjustment	SJT-	0-004A	A	638.00	669.49	703.24	719.00	732.48	761.74	788.73	860.73	924.84	1065.45
Mesh Back, Lumbar Adjustment													
Back Lock w/Fixed Seat	SJT-	0-011X	A	\$620.00	\$651.49	\$685.24	\$701.00	\$714.48	\$743.74	\$770.73	\$842.73	\$906.84	\$1047.45
Back Lock w/Seat Depth Adjustment	SJT-	0-011A	A	651.00	682.49	716.24	732.00	745.48	774.74	801.73	873.73	937.84	1078.45
Back Lock & Forward Tilt w/Seat Depth Adjustment	SJT-	0-014A	A	686.00	717.49	751.24	767.00	780.48	809.74	836.73	908.73	972.84	1113.45

The following options require modification of the product number.

- Knocked Down Shipment To specify, change the 11th digit from an **A** to **K** and deduct **\$30.00** list; **Example:** SJT-20-001X5K
- Stain Repellent (Fabric seat only) To specify, add **P** to the end of the product number and add **\$35.00** list; **Example:** SJT-20-001X5AP

Soji

Task Chair without Arms — Aluminum Base



SJT-20-011A

Dimensions

- *SH: 16.4"-21.0"
(417mm-533mm)
- H: 39"-44"
(991mm-1118mm)
- D: 27"(686mm)
- W: 28"(711mm)
- *SW: 20"(508mm)
- *SD: 16.25"-18.75"
(413mm-476mm)

Low position seat height:
14.75"-17.5"
(375mm-445mm)

* All measurements taken with the BIFMA chair measuring device.

Features

- Back: Knitted mesh.
- Seat: Standard upholstered foam covered in leather, fabric or faux leather. Available as a fixed seat or with seat depth adjustment (2.5"(64mm) range).
- Base: Aluminum five-star base.
- Lumbar: Available with optional lumbar support with 3.5"(89mm) adjustment.
- Mechanism: Synchronized tilt; standard tilt tension adjustment.
- Height adjustment: Standard pneumatic.
- Back Lock: Standard single position upright back lock.
- Optional Forward Tilt: 5° downward from initial position. Only available on chairs with seat depth adjustment.
- Casters: Hard casters in black or two-tone grey; Soft casters black only.
- COM yardage/COL square footage: (Seat only) 0.62/5.6
- Ships standard assembled. Optional knocked down shipment comes in three pieces; assembly does not require tools.

Specification Tip

- Lumbar color defaults based on chair attributes and is available in Black or Fog only.
 - Black will be received if Carbon knitted mesh is ordered or plastic trim color is Black.
 - Fog will be received if Fog or Snow plastic trim is ordered and knitted mesh is not Carbon.

To Order, Specify:

1) Product number, including;

1 Seat Upholstery:

- 1 Leather
- 2 Fabric
- 3 Faux Leather

2 Caster Option: Standard Base

- 1 Std. Base Hard Casters (Black)
- 2 Std. Base Soft Casters (Black)
- T Std. Base Hard Two-Tone Casters (Grey)

Low Base

- 3 Low Base, Hard Casters (Black)
- 4 Low Base, Soft Casters (Black)

2) Seat surface material and color.

3) Back surface material and color.

4) Plastic trim color.
TR-F Black
TR-7 Fog, add **\$65.00** list.
TR-UFM Snow, add **\$105.00** list.

5) Base color.
TR-F Black
TR-LE Metallic Silver
PM-P Polished Aluminum, add **\$187.47** list.

Description	Number		Fabric Grade							Leather Grade A	Leather Grade B		
	1	2	A	B	C	D	E	F	G			H	
Mesh Back, No Lumbar Adjustment													
Back Lock w/Fixed Seat	SJT-	0-001X	A	\$634.14	\$665.63	\$699.38	\$715.14	\$728.62	\$757.88	\$784.87	\$856.87	\$ 920.98	\$1061.59
Back Lock w/Seat Depth Adjustment	SJT-	0-001A	A	665.14	696.63	730.38	746.14	759.62	788.88	815.87	887.87	951.98	1092.59
Back Lock & Forward Tilt w/Seat Depth Adjustment	SJT-	0-004A	A	700.14	731.63	765.38	781.14	794.62	823.88	850.87	922.87	986.98	1127.59
Mesh Back, Lumbar Adjustment													
Back Lock w/Fixed Seat	SJT-	0-011X	A	\$682.14	\$713.63	\$747.38	\$763.14	\$776.62	\$805.88	\$832.87	\$904.87	\$ 968.98	\$1109.59
Back Lock w/Seat Depth Adjustment	SJT-	0-011A	A	713.14	744.63	778.38	794.14	807.62	836.88	863.87	935.87	999.98	1140.59
Back Lock & Forward Tilt w/Seat Depth Adjustment	SJT-	0-014A	A	748.14	779.63	813.38	829.14	842.62	871.88	898.87	970.87	1034.98	1175.59

The following options require modification of the product number.

- Knocked Down Shipment To specify, change the 11th digit from an **A** to **K** and deduct **\$30.00** list; **Example:** SJT-20-001X1K
- Stain Repellent (Fabric seat only) To specify, add **P** to the end of the product number and add **\$35.00** list; **Example:** SJT-20-001X1AP

UNL eBid 'Attribute' requirements:

Company profile:

encompas/Nebraska opened our showroom doors on Dec 1, 2013. **encompas** employs 37 people and produces revenues of approximately \$40 million, annually. Our team is comprised of architects, designers, and service professionals. **encompas** is a woman-owned business and holds certification from the Women's Business Enterprise National Council(WBENC).

Our primary manufacturer's alliance is with Haworth, headquartered in Holland, Michigan. Virtually all of Haworth's **products for the US market are manufactured in the United States**. Haworth is the 2nd largest manufacturer of office furniture on the planet and enjoys collaborative relationships with top design houses throughout Europe and the world.

Located in Omaha, and with showrooms also in Kansas City and Wichita, we are Nebraska's only authorized Haworth dealer. **encompas** enjoys Preferred Dealer status and we have won Best In Class designations every year since the inception of the program in 2011. The metrics used to select BIC dealers are stringent and **encompas** has been awarded first place in several categories and is recognized in the top 10 of Haworth's 220+ nationwide dealer network virtually every year. In addition to Haworth brands, 20% of our annual revenues come from the sales and support of over 200 other contract-grade furniture lines.

References:

University of Kansas | School of Endowment | Contact: Monte Soukup, VP for Property Management - Endowment Association | msoukup@kuendowment.org | (785) 832-7435 | Address: 1891 Constant Avenue Lawrence, Kansas 66044-0928 | Project nature: 7+ year relationship; new furniture and general moves, adds, and changes

University of Missouri | Donald W. Reynolds Journalism Institute | Contact: Becky Acton, Administrative Associate II | actonb@missouri.edu | (573) 882-2489 | Address: 310G Reynolds Journalism Institute, Columbia MO 65211-1200 | Project nature: 7+ year relationship; new furniture and general moves, adds, and changes

University of Kansas State | Justin Hall | Contact: Rita Newell, Assistant to the Dean – College of Human Ecology | renewell@k-state.edu | (785) 532-5503 | Address: 1324 Lovers Lane, Manhattan, Kansas 66506 | Project nature: 5+ year relationship; new furniture for open lounge, conference, and training rooms in the College of Human Ecology; accommodating over 2,500 students

Shawnee Mission School District | Center for Academic Achievement | Contact: Bob Robinson, Executive Director of Facilities and Support Services | bobrobinson@smsd.org | (913) 993-6401 | Address: 8200 West 71st Street, Overland Park, Kansas 66204 | Project nature: 2+ year relationship; new furniture for 130,000 sq ft Center for Academic Achievement....a state-of-the-art learning environment

Grand Construction | Contact: Lee Turner, Construction Manager | lturner@grandconst.com | (913) 648-9202 | Address: 1699 Village West Parkway Kansas City, Kansas 66111 | Project nature: 4+ year relationship; assists Grand Construction's clients with office furniture needs

References:

University of Nebraska Kearney | Health Science Education Complex | 2402 University Drive, Kearney NE 68849 | Contact: Dr. Gregory M. Karst, PhD Associate Executive Dean at UNMC College of Allied Health Professions | gmkarst@unmc.edu | (402) 559-6596 | Project nature: Classroom furniture for multiple floors including **classroom & faculty seating**, training, and collaborative tables. Project also included a 26-person faculty office with systems furniture, **task seating**, collaborative furniture, storage and break room furniture. This project started in the spring of 2015 and completed in time for commencement of the 2015 school year.

The contract amount between UNK & encompass for this project was \$750K

We have continued to provide product and services for additional needs, warranties, and services at UNK HSEC since completion in August of 2015.

University of Nebraska | College of Business (Howard Hawks Hall) | 730 N 14th St., Lincoln NE 68588-0405 | Contact: Rik Barrera | Associate Dean of Student Services and Chief Operating Officer | rbarrera1@unl.edu | (402) 472-9164 | Project nature: Private offices for 250+ faculty and students. **Nearly all student and faculty seating**. Collaborative furniture including power components. Conference tables. Lounge furniture for public spaces as well as specialty furniture for high impact areas such as Dean's Donor Lounge.

We worked closely with Rik and his team for nearly a year in the planning and implementation of the large, multi-phase furniture purchase that required careful planning due to a construction schedule that was somewhat of a moving target. The contract amount between UNL & encompass for this project was in excess of \$2.4M.

We have continued to provide product and services for additional needs at College of Business on an almost daily basis since completion in August of 2017.

4U

TASK | CONFERENCE | DRAFTING SEATING

mesh



mid back

groove



mid back

upholstered



mid back



high back

Italian design team SI DESIGN created our newest and boldest task chair series: 4U. Designed from the bottom up around you with a shape that fits you, supports you and looks great. An incredibly versatile series with upholstered, mesh, and welded fabric options. Utilizes the latest body balance technology mechanisms. Stool kit options can also be specified for sit-to-stand or elevated work surfaces. Finishes include black and white frame options, multiple base options (including white), 3 different colors of mesh, 3 colors of welded fabric (4U Groove) and upholstered back options.

True 48-Hour Commitment

- **20/48** 20 Chairs Every 48 Hours
- **10/48** 10 Chairs Every 48 Hours
- ▲ **CALL FOR LEAD TIME** (1-800-433-6614)



Passes or exceeds all BIFMA required testing.

\$625
BASE MODEL

4U - MESH MID BACK

ERGONOMIC TASK SEATING

STANDARD: 780-B-66C-0A-18BB-16HP-01U -GR A

True 48-Hour Commitment

- **20/48** 20 Chairs Every 48 Hours
- **10/48** 10 Chairs Every 48 Hours
- ▲ **CALL FOR LEAD TIME** (1-800-433-6614)

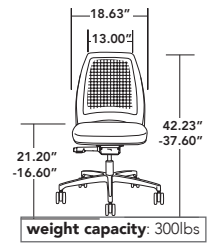

Step 1: SEATS (MODEL#)

780 • STANDARD
medium (B) seat
seat only: COM 0.75 yd; COL 7.5 sq. ft.

781 • +\$77
large (C) seat
seat only: COM 1.0 yd; COL 8.0 sq. ft.

Step 2: SHELL COLORS

- **-B black** ● **STANDARD**
- **-W white** ● **\$51**

Step 2a: LUMBAR OPTIONS

- **-LS4B** ● **\$61**
- **-LS4W** ● **\$61**

Step 3: CONTROLS

-66C • STANDARD
basic body balance

-68C • \$117
Enhanced Body Balance

swivel & tilt control
35C-11DR • \$203
tall stool kit
35C-11XDR • \$203
extra tall stool kit
(medium seats only)

Step 3a: SLIDER

-12SS • \$84
Seat Slide
● **STANDARD** on 780
(66C & 68C only)

Step 4: ARMS

NO ARMS
-0A
STANDARD

forward angle, height adjustable arm
33A0 • \$117
nylon, black
rotating 0 arm cap, black
35A0 • \$163
nylon, white
rotating 0 arm cap, black

adjustable height arm height: 7.0" to 9.75" (from top of seat)
38A • \$51
nylon, black

fixed conference
46A • \$77
polyurethane, black

adjustable height roll back arm height: 7.0" to 9.75" (from top of seat)
39A • \$102
nylon, black

adjustable height arm height: 7.5" to 11.5" (from top of seat)
51A • \$82
nylon, black
52A • \$107
nylon, white
53A • \$138
aluminum, polished

Step 4a: CAPS

- standard cap

Step 4b: BRACKETS

-19AB • \$31
width adjustable bracket

(N/A)

-19AB • \$31
width adjustable bracket

Step 5: BASES

-18BB • STANDARD
26" black polyurethane

-18PB • \$105
26" polished aluminum

-18BA • \$105
26" brushed aluminum

-18WB • \$105
26" white aluminum

Step 5a: CASTERS

SUFFIX	QS	DESCRIPTION	PRICE
-16HP	●	black carpet	STANDARD
-16SCG	●	gray hard floor	\$27
-16GL	●	glide	\$27

Step 6: MESH COLORS

NO UPCHARGE	SUFFIX	QS	DESCRIPTION	SUFFIX	QS	DESCRIPTION	SUFFIX	QS	DESCRIPTION
	-01U	●	black	-02U	●	stardust	-03U	●	graphite

Step 7: FABRIC GRADES

Fabric Upgrade	A	B	1/COM	2	3/COL	4	5	6	7	8
Upcharge	STANDARD	\$12	\$38	\$55	\$83	\$112	\$143	\$180	\$219	\$262

BUILD YOUR PART NUMBER



\$663
BASE MODEL

4U GROOVE - WELDED MID BACK

ERGONOMIC TASK SEATING

STANDARD: 785-B-66C-0A-18BB-16HP-01W -GR A

True 48-Hour Commitment

● **20/48** 20 Chairs Every 48 Hours

○ **10/48** 10 Chairs Every 48 Hours

▲ **CALL FOR LEAD TIME** (1-800-433-6614)

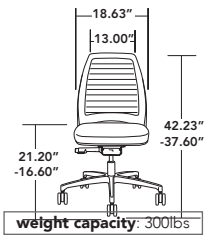

Step 1: SEATS (MODEL #)

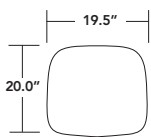

785 • STANDARD
medium (B) seat

seat only: COM 0.75 yd; COL 7.5 sq. ft.

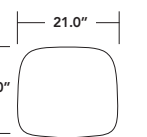

786 • +\$77
large (C) seat

seat only: COM 1.0 yd; COL 8.0 sq. ft.

Step 2: SHELL COLORS

■ **-B** black ● **STANDARD**

□ **-W** white ● **\$51**

Step 2a: LUMBAR OPTIONS

■ **-LS4B** ● **\$61**

□ **-LS4W** ● **\$61**

Step 3: CONTROLS

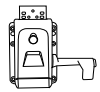

-66C • STANDARD
basic body balance

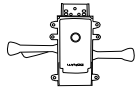

-68C • \$117
Enhanced Body Balance

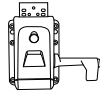

swivel & tilt control
35C-11DR • \$203
tall stool kit
35C-11XDR • \$203
extra tall stool kit
(medium seats only)

Step 3a: SLIDER

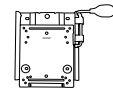

-12SS • \$84
Seat Slide
● **STANDARD** on 785
(66C & 68C only)

Step 4: ARMS

NO ARMS
-0A
STANDARD



forward angle, height adjustable arm
33A0 • \$117
nylon, black
rotating 0 arm cap, black
35A0 • \$163
nylon, white
rotating 0 arm cap, black



adjustable height
arm height: 7.0" to 9.75"
(from top of seat)
38A • \$51
nylon, black



fixed conference
46A • \$77
polyurethane, black



adjustable height roll back
arm height: 7.0" to 9.75"
(from top of seat)
39A • \$102
nylon, black



adjustable height roll back
arm height: 7.5" to 11.5"
(from top of seat)
51A • \$82
nylon, black
52A • \$107
nylon, white
53A • \$138
aluminum, polished

Step 4a: CAPS

● standard cap



1 3 4 5 6 7 8 12
NO UPCHARGE

-19AB • \$31
width adjustable bracket

(N/A)



1 3 4 5 6 7 8 12
NO UPCHARGE

(N/A)



18S 20S 18R 20R
Full Function
NO UPCHARGE

-19AB • \$31
width adjustable bracket

Step 4b: BRACKETS

Step 5: BASES



-18BB • STANDARD
26" black polyurethane



-18PB • \$105
26" polished aluminum



-18BA • \$105
26" brushed aluminum



-18WB • \$105
26" white aluminum

Step 5a: CASTERS

SUFFIX	QS	DESCRIPTION	PRICE
-16HP	●	black carpet	STANDARD
-16SCG	●	gray hard floor	\$27
-16GL	●	glide	\$27

Step 6: WELDED FABRIC COLORS

NO UPCHARGE

■ SUFFIX **-01UG** QS ● DESCRIPTION black

■ SUFFIX **-02UG** QS ● DESCRIPTION light grey

■ SUFFIX **-03UG** QS ● DESCRIPTION dark grey

Step 7: FABRIC GRADES

Fabric Upgrade	A	B	1/COM	2	3/COL	4	5	6	7	8
Upcharge	STANDARD	\$12	\$38	\$55	\$83	\$112	\$143	\$180	\$219	\$262

BUILD YOUR PART NUMBER



\$686
BASE MODEL

4U - UPHOLSTERED

ERGONOMIC TASK SEATING

STANDARD: 770-B-66C-0A-18BB-16HP-GR A

True 48-Hour Commitment

- **20/48** 20 Chairs Every 48 Hours
- **10/48** 10 Chairs Every 48 Hours
- ▲ **CALL FOR LEAD TIME** (1-800-433-6614)

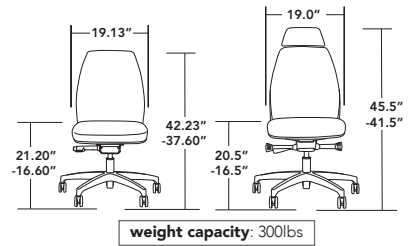

Step 1: BACKS & SEATS (MODEL#)

mid backs

770 • STANDARD
medium (B) seat

back only: COM 1.0 yd; COL 6.5 sq. ft.
seat only: COM 0.75 yd; COL 7.5 sq. ft.

771 • +\$77
large (C) seat

back only: COM 1.0 yd; COL 6.5 sq. ft.
seat only: COM 1.0 yd; COL 8.0 sq. ft.

high backs

775 • +\$123
medium (B) seat

back only: COM 1.0 yd; COL 8.0 sq. ft.
seat only: COM 0.75 yd; COL 7.5 sq. ft.

776 • +\$199
large (C) seat

back only: COM 1.0 yd; COL 8.0 sq. ft.
seat only: COM 1.0 yd; COL 8.0 sq. ft.

Step 2: SHELL COLORS

- **-B** black ● **STANDARD**
- **-W** white ● **\$51**

Step 3: CONTROLS

-66C • STANDARD
basic body balance

-68C • \$117
Enhanced Body Balance

swivel & tilt control
35C-11DR • \$203
tall stool kit
35C-11XDR • \$203
extra tall stool kit
(medium seats only)

Step 3a: SLIDER

-12SS • \$84
Seat Slide

● **STANDARD** on 770, 775
(66C & 68C only)

Step 4: ARMS

NO ARMS
-0A
STANDARD

forward angle, height adjustable arm
33A0 • \$117
nylon, black
rotating 0 arm cap, black

35A0 • \$163
nylon, white
rotating 0 arm cap, black

adjustable height arm
arm height: 7.0" to 9.75"
(from top of seat)
38A • \$51
nylon, black

fixed conference
46A • \$77
polyurethane, black

adjustable height roll back
arm height: 7.0" to 9.75"
(from top of seat)
39A • \$102
nylon, black

adjustable height arm
arm height: 7.5" to 11.5"
(from top of seat)
51A • \$82
nylon, black

52A • \$107
nylon, white

53A • \$138
aluminum, polished

Step 4a: CAPS

● standard cap



(N/A)



(N/A)



-19AB • \$31
width adjustable bracket

Step 4b: BRACKETS

Step 5: BASES

-18BB • STANDARD
26" black polyurethane

-18PB • \$105
26" polished aluminum

-18BA • \$105
26" brushed aluminum

-18WB • \$105
26" white aluminum

Step 5a: CASTERS

SUFFIX	QS	DESCRIPTION	PRICE
-16HP	●	black carpet	STANDARD
-16SCG	●	gray hard floor	\$27
-16GL	●	glide	\$27

Step 6: FABRIC GRADES

Fabric Upgrade	A	B	1/COM	2	3/COL	4	5	6	7	8
Mid Back Upcharge	STANDARD	\$12	\$38	\$55	\$83	\$112	\$143	\$180	\$219	\$262
High Back Upcharge	STANDARD	\$14	\$44	\$64	\$96	\$130	\$166	\$209	\$256	\$304

BUILD YOUR PART NUMBER



Great Expectations

You have them. And so do we. That's why we back our products with a comprehensive warranty plan. At Haworth, **we value our customers**, and this is part of our pledge to be the best partner for your organization and to provide future assurance through integrated, adaptable products and sustainable environments.

PRODUCT NON-OBSOLESCENCE AND WARRANTY POLICY

This North American Haworth Product Non-Obsolescence and Limited Warranty Policy (the "policy") applies to products manufactured after May 8, 2015. For products manufactured before this date please refer to the policy published in the NA Price List when purchased or contact your local Authorized Haworth Dealer. All Haworth products are warranted for 24 hour / 7 day use over the length of the Applicable Warranty Period as set forth below.

Haworth, Inc. or Haworth, Ltd., (each called "Haworth") will make a good faith effort to maintain product compatibility within our various generations of integrated product platforms to provide our customers with spaces that adapt to change. Under our non-obsolence policy, we commit to provide our customers with products of comparable function or operational characteristics for a term equal to the Applicable Warranty Period. Haworth fabrics and finishes must be updated periodically to maintain the market appeal of our products and respond to the demands and changing preferences of our customers. As a result, we or the manufacturer may discontinue some fabrics and finishes before expiration of the Applicable Warranty Period. If a new product purchased or leased

from Haworth or from an Authorized Haworth Dealer proves to be defective (as defined below) while the product is still in the possession of the initial purchaser or lessee and if they, within the Applicable Warranty Period, inform Haworth of the defect by contacting the local Authorized Haworth Dealer, then, except as provided below, Haworth will, at Haworth's option, either repair or replace the product, at Haworth's expense, or refund the purchase price of the product. Except as provided below, a product shall be considered "defective" if Haworth finds that it is defective in material or workmanship and if the defect materially impairs the use of the product to the purchaser or lessee. The applicable warranty period begins on the day the product is manufactured. If a product that the purchaser or lessee references in a notice of defect was not installed by a Haworth Certified installer and/or reconfigured by a Haworth-trained installer, then the product may not be considered defective and Haworth will not be obligated to repair or replace it or to refund its price.

PRODUCTS / APPLICABLE WARRANTY PERIOD

LIFETIME

All Haworth products are warranted for lifetime *except products, components and materials described below:*

TWELVE YEARS

All Haworth NA manufactured seating is warranted for 24/7 multiple shift use by persons up to 325 lbs and includes the framework, mechanisms, seating foam, seat & back mesh and seating glides & casters.

All wood or wood framed products.

TEN YEARS

All wall products (excluding soft close door mechanisms warranted for Two Years), electrical components (excluding Power Base™ AI, USB receptacles and workware products), electrical accessories, fixed task lighting (excluding LED lighting), adjustable keyboard pads, monitor arms and products that are at any time used in a classroom or educational environment (other than administration areas) except as limited or described below:

FIVE YEARS

Fabric scrims and fabrics rated Heavy Duty (A) under the Association of Contract Textiles Guidelines, leather, vertical use markerboard laminates, user-adjustable worksurface mechanisms, gel arm caps, thermofused laminates, slow close mechanisms, LED lighting, Power Base™ receptacles with USB charging outlets, electronic ballasts used in task lighting, horizontal glass or thermoplastic table assemblies and Systems Accessories.

THREE YEARS

Power Base AI Electrical products, workware™ products, Hoop products (excludes any warranty for surface damage such as scratches, dents or abrasions), plastic ultraviolet light color fastness and fabrics rated General Contract (a) under the Association of Contract Textiles Guidelines.

ONE TO FIVE YEARS**

Products that are manufactured outside North America and sold into the North American market.

ONE YEAR

Horizontal use markerboard laminate, Openest™ Plume Screens, soft palm rest, mouse pad insert and translucent edging.

Haworth "Specials" products that involve simple modification of a standard based product will be warranted for the same period as the standard catalog product it is based on. Haworth "Specials" products that deviate from standard catalog product in the form of features, construction, function, or aesthetic will be warranted for 1 year.

All software is without warranty of any kind, either expressed or implied.

All service parts are warranted for two years or the remaining balance of the assembly's original warranty period, whichever is longer.

* The Applicable Warranty Period for each such product is specified in Haworth's price list for the product.

A product will not be considered to be defective, and Haworth will not repair, or replace it or refund its price if the product (1) is a consumable product, such as a lamp; (2) is "Customer's Own Material" (i.e. material specified by the purchaser or lessee that is not a standard Haworth product offering, such as Haworth Alliance fabrics); (3) is not installed and used as recommended in Haworth's written specification, installation, care, maintenance and user guides; (4) has been otherwise misused or suffered abusive damage or (5) is a product that is manufactured by a third-party supplier from whom Haworth purchases it for resale without incorporating it into Haworth product (in which case Haworth will assign to the purchaser or lessee any warranty that the manufacturer provides), unless otherwise specified by Haworth in writing. At all times the Covered Product must have been located in a building that is (i) dry, fully closed-in and protected from the natural elements, and (ii) adequately heated, ventilated and air conditioned in order to maintain an internal temperature between 40°F and 90°F (4°C and 32°C) and relative humidity levels between 25% and 55%.

A defect in material or workmanship does not include damage to a product, or failure of a product to operate or perform properly or to maintain appearance, caused by (a) normal wear and tear; (b) an Act of God or transportation; (c) a product alteration made without Haworth's express written authorization; (d) the natural variation of color, grain or texture found in wood and leather; (e) the natural aging found in materials such as wood, fabric and leather which results in colors shifting during use; (f) dye lot variations in fabric, leather or wall covering (g) the natural patina of leather during use; (h) "puddling" of leather or faux leather; or (i) reverse crocking of dyes from clothing onto our seating materials.

EXCEPT AS STATED ABOVE, HAWORTH DOES NOT MAKE A WARRANTY AS TO ANY PRODUCT AND, IN PARTICULAR, DOES NOT MAKE A WARRANTY OF MERCHANTABILITY OR OF FITNESS FOR A PARTICULAR PURPOSE. Product repair or replacement or refund of the price, at Haworth's option, in accordance with this Policy, is the purchaser's or lessee's exclusive remedy for a product defect. Haworth shall not have tort liability with respect to a product, and Haworth shall not be liable for any consequential, economic, indirect, special, punitive or incidental damages arising from a product defect. Haworth shall not be liable for repair or product replacement due to improper installation or any defect in materials used for installation which are not manufactured, sold or supplied by Haworth.

Released May 8, 2015



via seating warranty statement

via seating has one of the strongest warranties in the industry. via seating warrants to the initial purchaser, that product will be free from defects in its materials and craftsmanship found during normal single shift usages; single shift usage is five (5) days a week, eight (8) hours a day for the following warranty periods. This coverage shall be effective for the applicable time period beginning from date of original sale.

unless otherwise specified, all components are covered by via seating's warranty – including foam

warranty coverage defined as:

- All via seating products – INCLUDING VIA SEATING SIGNATURE FOAM– are warranted for 12 Years.

please note exceptions below:

24/7 shift applications: 12 year warranty coverage:

- 12 Years – Brisbane HD, 24/7 (2 years for fabric) – Genie 24/7 – (5 years for mesh)
- 12 Years – Vista Classic, Vista II

other exceptions:

- 10 Years – Vista Classic, Vista II – with casters
- 6 Years – Astro, Chico, Edge, Sienna, Splash, Sutro, Zee
- 5 Years – QS leathers and fabric, 4U, 4U Breeze welded fabric, Genie™ mesh, Sierra, Swopper, Tahoe
- 3 Years – 3Dee, muvman, oyo, oyo living
- 2 Years – Mesh back fabric (Proform, Riva, Run II, Vista II, Voss), Run II patchwork mesh*purchase/use of mesh guards increase warranty to 5 years for mesh backs on the Riva, Voss & Proform series*
- 2 Years – Mechanical lumbar & air lumbar options

Products covered by this warranty will be either repaired or replaced at via seating's discretion. Product repair or replacement of any defective part is the customer's exclusive remedy for any and all product defects. via seating will pay for warranty repair costs that are pre-approved when shown to be a result of a defective part. Such payment will be made in the form of a credit to an active authorized via seating dealer account. Should via seating and customer agree that repair or replacement of a chair is impractical, or impossible any and all warranties shall expire, via seating accepts no other responsibilities or liabilities. The user shall be responsible for all maintenance service, which includes but not limited to: lubricating and cleaning of the product, assembly, adjustment, checking all screws every six months and performing operation checks. Only those items free of misuse, abuse, accident, alteration, unauthorized repair, or damage by fire, flood, or other acts of God will be covered. This warranty applies to all via seating products manufactured after December 11, 2017. There are no other warranties, expressed or implied, other than those specifically described here.

not covered under warranty:

- COM/COL textiles
- Matching of colors, patterns or dye lot, including; minor variations, color matches to swatches used for specification purposes and/or prior purchases
- Products specified outside of those shown on this page above
- Products that have unauthorized repair or alteration
- Products not used, maintained or installed in accordance with via seating's applicable guidelines
- Products exposed to conditions deemed extreme i.e. environments other than "normal commercial, indoor office" spaces
- Products sold by unauthorized via seating dealers or second hand/refurbished products
- Variations of leather; dye lots, environment marks, scars, bites, rubs, wrinkles, stretch marks, pattern markings, etc.
- Samples, floor/showroom samples, road samples

warranty claims:

- Do not return the product without prior Return Material Authorization (RMA) from via seating
- Send a written notification (with pictures) of the defect to via seating along with a copy of the original invoice in order to generate a Return Material Authorization
- Please contact via seating customer service at 1-800-433-6614 for details or email warranty@viaseating.com

ANSI/BIFMA compliance:

- via seating products – via seating designs and manufactures all of its products in accordance with the ANSI/BIFMA standards
- Motion Products – aeris GMBH manufactures all of these products in accordance with European DINN standards

product design:

- via seating reserves the right to make changes in design and construction or discontinue products without notice
- All dimensions noted herein are approximate and subject to slight deviation