

City of Lincoln/Lancaster County (Lincoln Purchasing) Supplier Response

Bid Information		Contact Information		Ship to Information
Bid Creator	Rachelle Hinze, Buyer	Address	Purchasing	Address
Email	rhinze@lincoln.ne.gov		440 S. 8th St.	
Phone	1 (402) 441-8313		Lincoln, NE 68508	
Fax	1 (402) 441-6513	Contact	Rachelle Hinze, Buyer	Contact
Bid Number	17-140	Department		Department
Title	Annual Supply - Workstations and Accessories	Building	Suite 200	Building
Bid Type	Bid	Floor/Room		Floor/Room
Issue Date	5/15/2017 09:01 AM (CT)	Telephone	1 (402) 441-8313	Telephone
Close Date	6/2/2017 12:00:00 PM (CT)	Fax	1 (402) 441-6513	Fax
		Email	rhinze@lincoln.ne.gov	Email

Supplier Information

Company OFFICE INTERIORS & DESIGN, INC.
 Address 121 CHERRY HILL BLVD.

 LINCOLN, NE 68510
 Contact Nancy Kraft
 Department
 Building
 Floor/Room
 Telephone (402) 484-7500
 Fax (402) 484-7575
 Email NANCY.KRAFT@OIDINC.COM
 Submitted 6/2/2017 10:45:10 AM (CT)
 Total \$0.00

By submitting your response, you certify that you are authorized to represent and bind your company.

Signature Nancy Kraft

Email nancy.kraft@oidinc.com

Supplier Notes

Bid Notes

Bid Activities

Bid Messages

Bid Attributes

Please review the following and respond where necessary

#	Name	Note	Response
1	U.S. Citizenship Attestation	<p>Is your company legally considered an Individual or Sole Proprietor: YES or NO</p> <p>As a Vendor who is legally considered an Individual or a Sole Proprietor I hereby understand and agree to comply with the requirements of the United States Citizenship Attestation Form, available at: http://www.sos.ne.gov/business/notary/citizenforminfo.html</p> <p>All awarded Vendors who are legally considered an Individual or a Sole Proprietor must complete the form and submit it with contract documents at time of execution.</p> <p>If a Vendor indicates on such attestation form that he or she is a qualified alien, the Vendor agrees to provide the US Citizenship and Immigration Services documentation required to verify the Vendor's lawful presence in the United States using the Systematic Alien Verification for Entitlements (SAVE) Program.</p> <p>Vendor further understands and agrees that lawful presence in the United States is required and the Vendor may be disqualified or the Contract terminated if such lawful presence cannot be verified as required by Neb. Rev. Stat. 4-108.</p>	No
2	Bid Documents	I acknowledge and accept that it is my responsibility as a Bidder to promptly notify the Purchasing Department Staff prior to the close of the bid of any ambiguity, inconsistency or error which I may discover upon examination of the bid documents including, but not limited to the Specifications.	Yes
3	Instructions to Bidders	I acknowledge reading and understanding the Instructions to Bidders.	Yes
4	Insurance Requirements and Endorsements	<p>Vendor agrees to provide insurance coverage for each checked box on the Insurance Clause document in the Bid Attachments including the submission of the Certificate of ACORD and the applicable endorsements:</p> <p>Insurance Certificate and required Endorsements are required at time of contract execution by the vendor.</p> <p>Vendors are strongly encouraged to send the insurance requirements and endorsement information to their insurance agent prior to bid close in order to expedite the contract execution process.</p>	Yes
5	Special Provision Term Contract Provisions	I acknowledge reading and understanding the Special Provision Term Contract Provisions.	Yes
6	Quantities	I acknowledge that the quantities listed for each line item are an estimated yearly amount. The City does not guarantee any dollar amount or order quantities for the term of the contract.	Y
7	Brochure/Specifications	I acknowledge that I have attached the brochure/specifications of the product(s) I am bidding.	Yes
8	Sample Contract	I acknowledge reading and understanding the sample contract.	Yes

9	Specifications	I acknowledge reading and understanding the specifications.	Yes
10	Term Clause of Contract	I acknowledge that the term of the contract is for a one (1) year term with the option for three (3) additional one (1) year renewals from the date of the executed contract. (a) Are your bid prices firm for the first one (1) year contract period. YES or NO (b) Are your bid prices subject to escalation/de-escalation YES or NO (c) If (b), state period for which prices will remain firm: through _____	Yes,
11	Purchase Order, Contract and Delivery Contact	The City/County Purchasing Department issues Purchase Orders and Contracts via email to a designated contact person of the awarded Vendor. This designee will be the primary contact with the department through the delivery of the product/services. Please list the name, email address and phone number of the person who will be the contact person for the PO to be awarded.	Nancy Kraft, nancy.kraft@oidinc.com, 402-484-7500.
12	Contract and Delivery Contact	The City/County Purchasing Department will issue a Contract via email to a designated contact person of the awarded Vendor. This designee will be the primary contact with the department through the delivery of the product/services. Please list the name, email address and phone number of the person who will be the contact person for the PO to be awarded.	Nancy Kraft, nancy.kraft@oidinc.com 402-484-7500
13	Contact	Name of person submitting this bid:	Nancy Kraft
14	Electronic Signature	Please check here for your electronic signature.	Yes

Line Items

#	Qty	UOM	Description	Response
1	1	EA	This is to notify you that Bid 17-140 for Sit to Stand Workstations and Accessories is available. Please prepare your written response and attach your proposals as instructed in the specifications. Respond to the Attribute section (above) of this electronic bid and submit before the closing date and time. Also, you are required to enter a 0 for your response in this line item. If you have any questions, call 402-441-8313.	\$0.00

Item Notes:

Supplier Notes:

Response Total: \$0.00

Prepared for:

CITY OF **LINCOLN** NEBRASKA

BID NUMBER: 17-140

Ergonomics Workstations & Accessories Bid

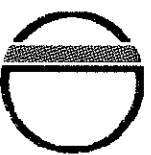

**OFFICE INTERIORS
& DESIGN**

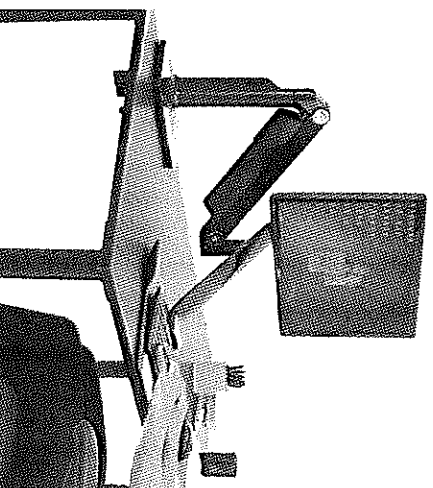
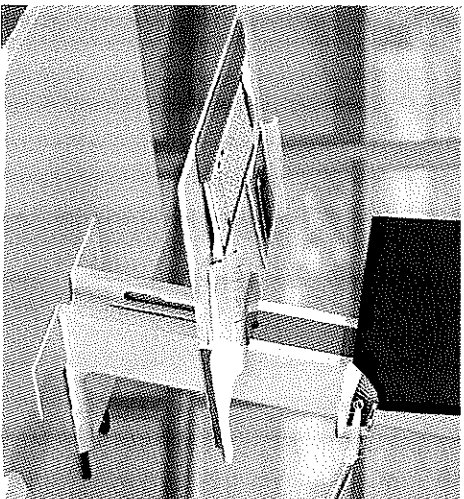
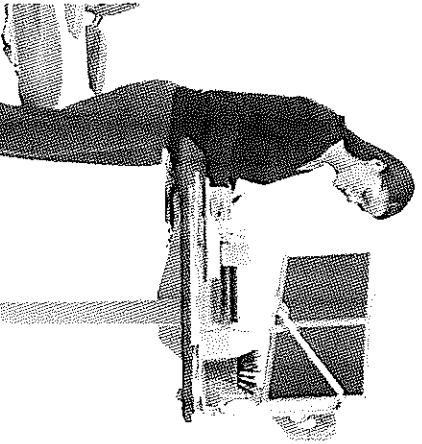
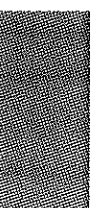

ELECTRIC / HEIGHT ADJUSTABLE / COMPLETE DESK

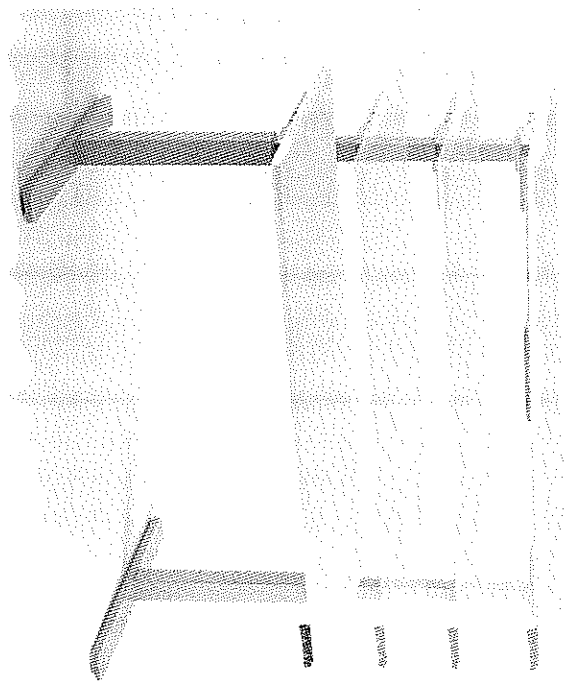
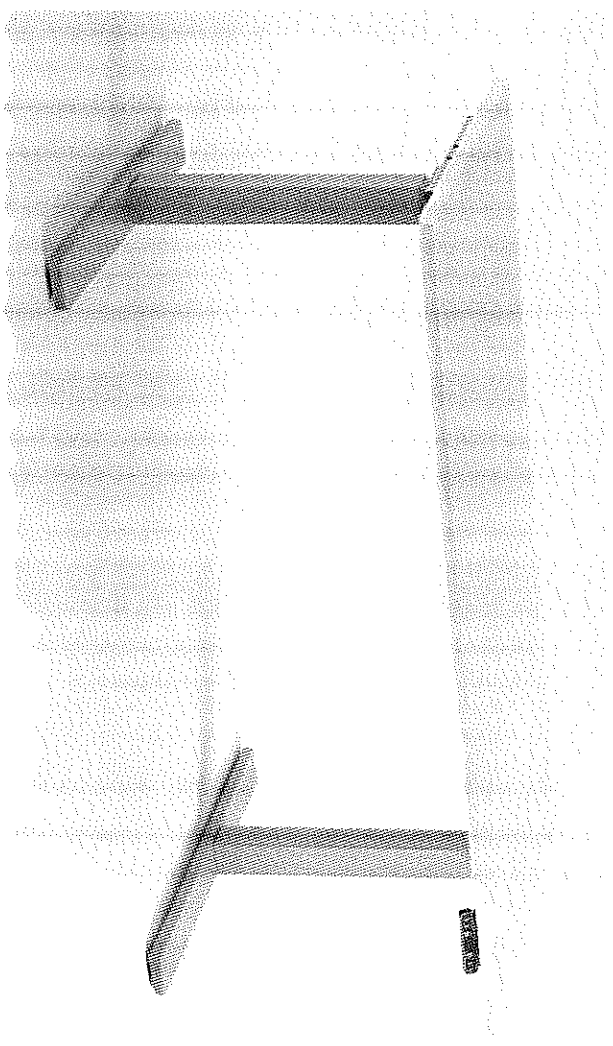

TEKNION / HISPACE ELECTRIC DESK

**Complete Height Adjustable Desk w/ Top*

<http://www.teknion.com/ca/products/galleries/hispace-gallery>

- Foundation HPL Laminate Top
- Platinum (Silver) Metal Base
- Memory Display Switch
- 200lb Rise Capacity
- Range: 25.5" – 50.5"H

24"D x 48"W	\$626.75
30"D x 60"W	\$670.56
30"D x 72"W	\$695.64
(*Available 24-30"D x 48-72"W)	
Installation	\$150



ELECTRIC / HEIGHT ADJUSTABLE / BASE ONLY

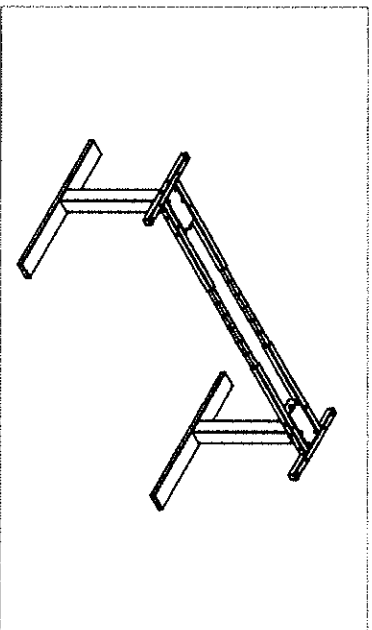
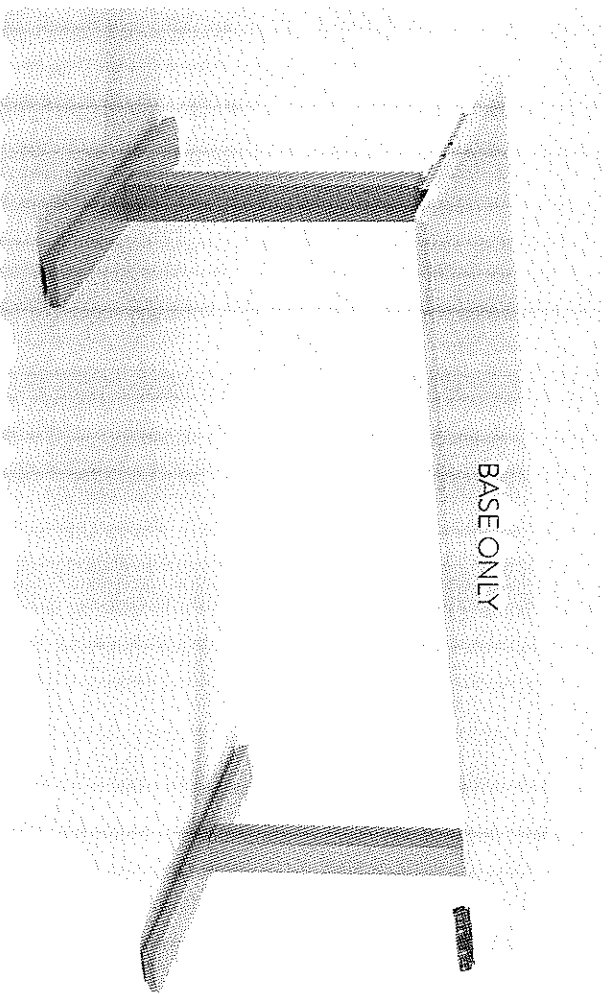

TEKNION / HiSPACE ELECTRIC BASE ONLY

**Base Only (For retrofitting existing rectangle tops)*

<http://www.teknion.com/ca/products/galleries/hispace-gallery>

- Platinum (Silver) Metal Base
- (*Available 24-30"D x 48-72"W)
- Memory Display Switch
- 200lb Rise Capacity
- Range: 25.5" – 50.5"H

24" -30"D x 48" -72W \$515.62

(*Telescoping base fits under a variety of sized tops)

Installation \$125



COUNTERBALANCE / HEIGHT ADJUSTABLE / COMPLETE DESK

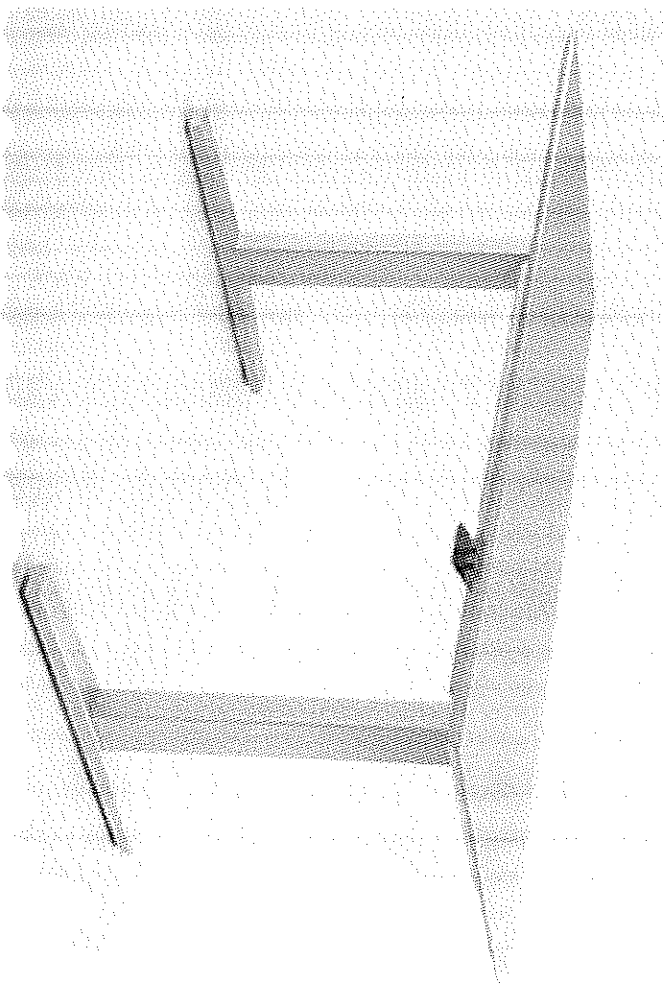

TEKNION / LIVELLO COUNTERBALANCE

*Complete Height Adjustable Desk w/ Top

<http://www.teknion.com/products/galleries/livello-tables-gallery>

Foundation HPL Laminate Top
 Foundation Metal Base
 (*Available 24 - 30"D x 42 - 84"W)
 150lb Rise Capacity (minus weight of worksurface)
 Counterbalance Mechanism

Standard Range: 29" – 49"H
 Extended Range: 26" – 43"H

24"D x 48"W	\$835.98
30"D x 60"W	\$893.76
30"D x 72"W	\$932.18
Installation	\$150

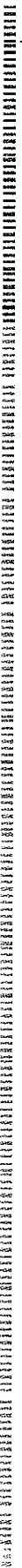

COUNTERBALANCE / HEIGHT ADJUSTABLE / BASE ONLY

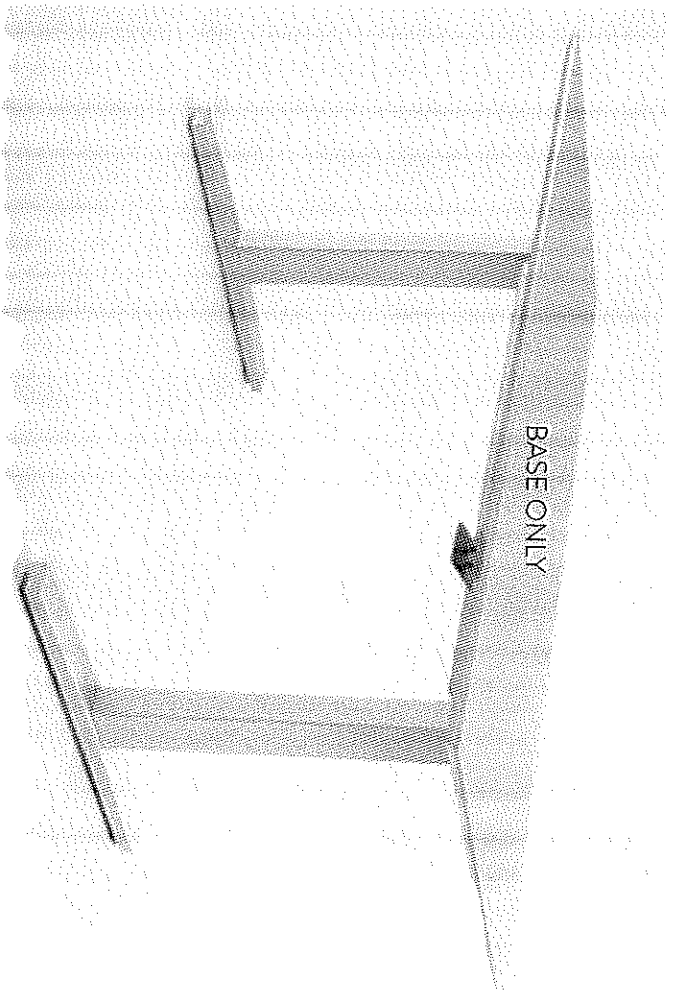

TEKNION / LIVELLO COUNTERBALANCE

***Base Only (For retrofitting existing rectangle desks)**

<http://www.tekunion.com/products/galleries/livello-tables-gallery>

Foundation Metal Base
 (*Available 24-30"D x 42-84"W)
 150lb Rise Capacity (minus weight of worksurface)
 Counterbalance Mechanism

Standard Range: 29" – 49"H
 Extended Range: 26" – 43"H

24"D x 48"W	\$771.53
30"D x 60"W	\$831.85
30"D x 72"W	\$849.00
Installation	\$125

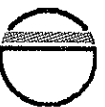

COUNTERBALANCE / HEIGHT ADJUSTABLE / BASE ONLY

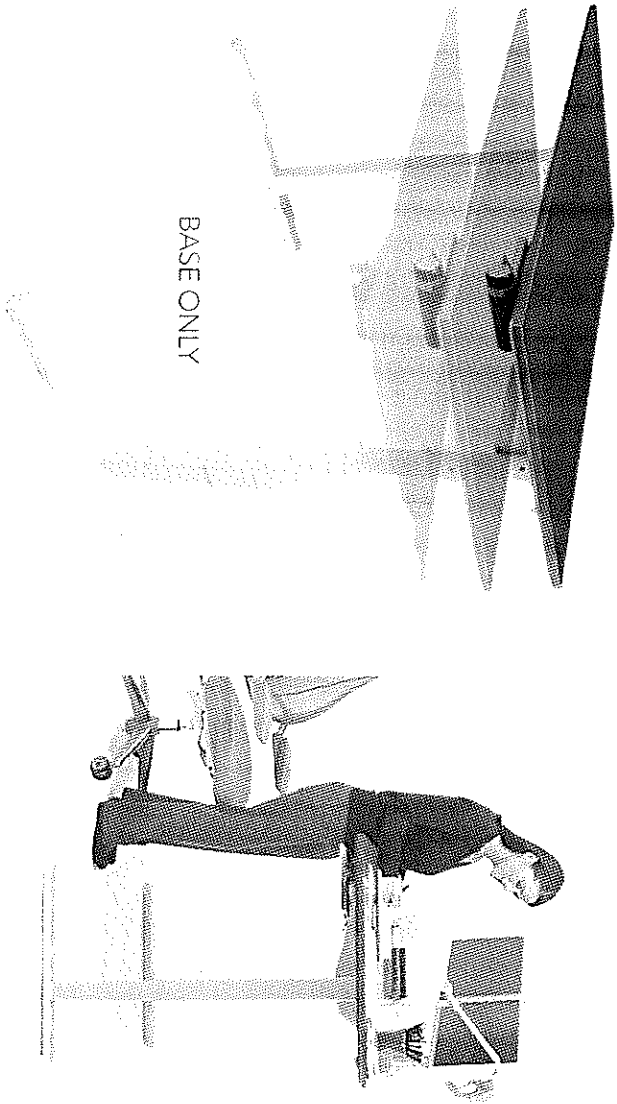

HUMANSCALE / FLOAT COUNTERBALANCE

**Base Only (For retrofitting existing rectangle desks)*

<https://www.humanscale.com/products/product.cfm?group=float>

Silver, Black or White
(*Available 24-30"D x 42-84"W)

Standard Range: 26.4" - 46.2"H

24"D x 48"W	\$899.50
30"D x 60"W	\$924.50
30"D x 72"W	\$924.50
Freight	4% of sell price
Installation	\$125

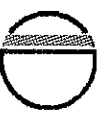

ELECTRIC / HEIGHT ADJUSTABLE / BASE ONLY (Extended Corner)

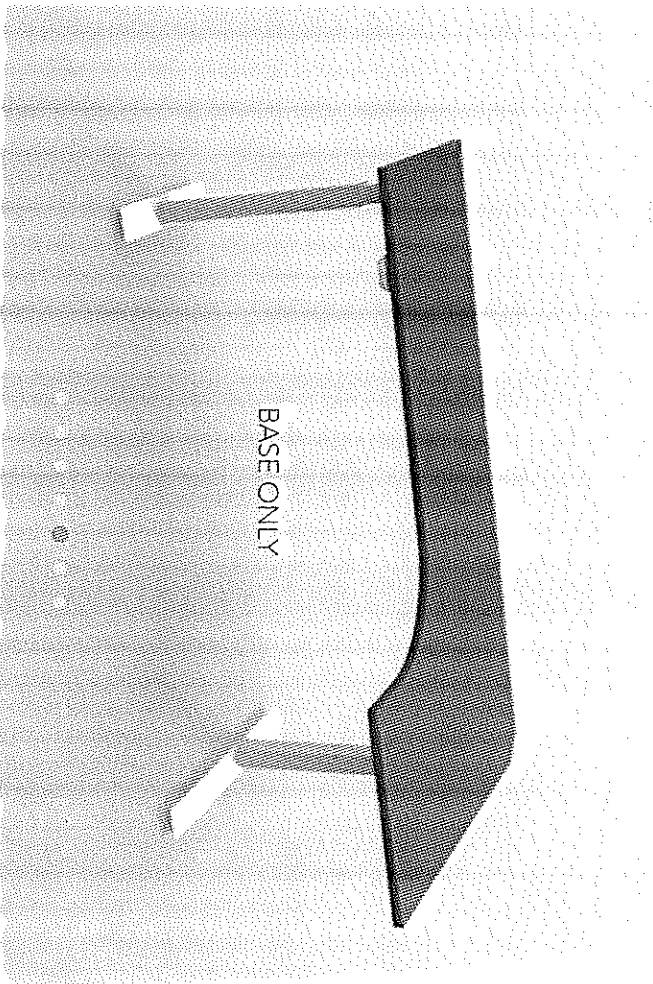

Symmetry Voyager for Extended Corner Desks

***Base Only (For retrofitting existing extended corner desks)**

<http://www.symmetryoffice.com/products/401498/>

- Silver, White or Black
- Basic Up/Down Switch
- Range: 28" - 47"H
- 220lb Rise Capacity

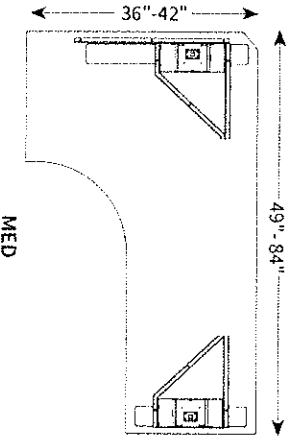

36-42"D x 48"-84W	\$531.00
Freight:	
1-6 Bases	\$65 each
7-18 Bases	\$35 each
19+ Bases	Free
(*Telescoping base fits under a variety of sized tops)	
Installation	\$125



ELECTRIC / HEIGHT ADJUSTABLE / BASE ONLY (3-Leg)

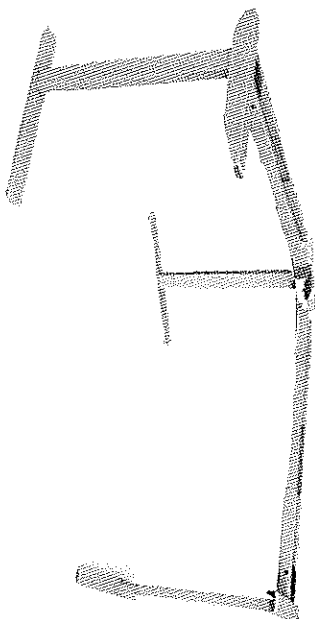
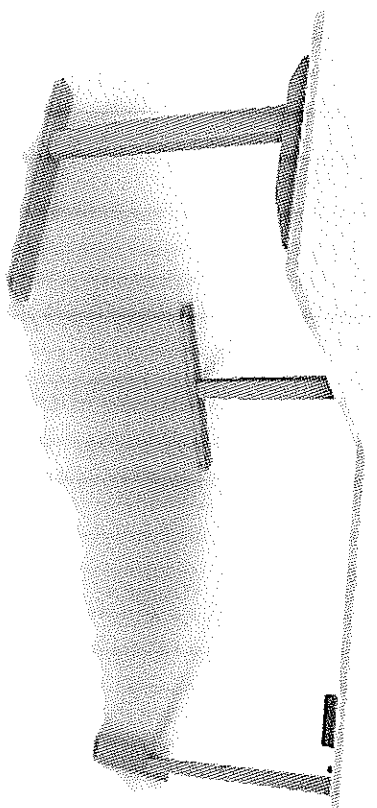

BASE ONLY

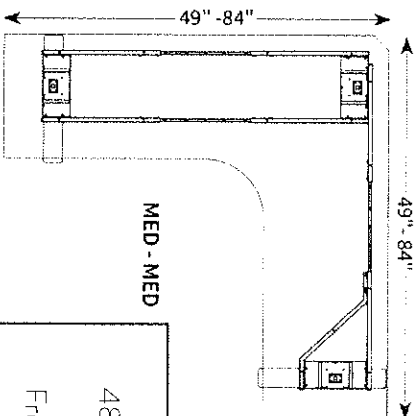

MED - MED

SYMMETRY / ENDEAVOR 3-Leg Electric Base Only
 *Base Only (For retrofitting existing extended corner desks)

<http://www.symmetrystore.com/products/9/662/>

- Silver Base
- Display Memory Switch
- Range: 24.6" – 49.8"H
- 330lb rise capacity

48-84"D x 48"-84W	\$646.00
Freight:	
1-6 Bases	\$82 each
6-15 Bases	\$41 each
16+ Bases	Free
(*Telescoping base fits under a variety of sized tops.)	
Installation	\$150

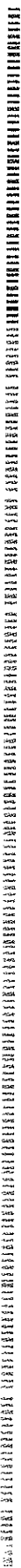

HEIGHT ADJUSTABLE / DESK MOUNTED

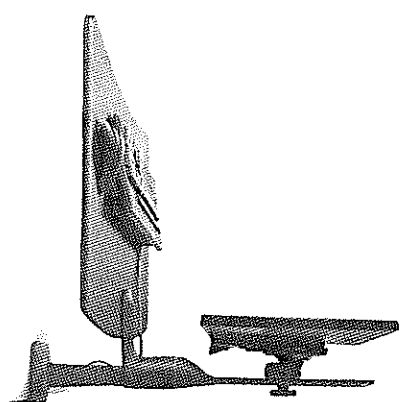
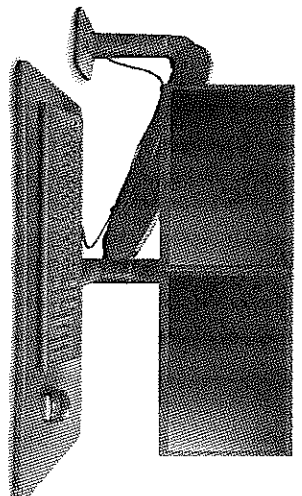
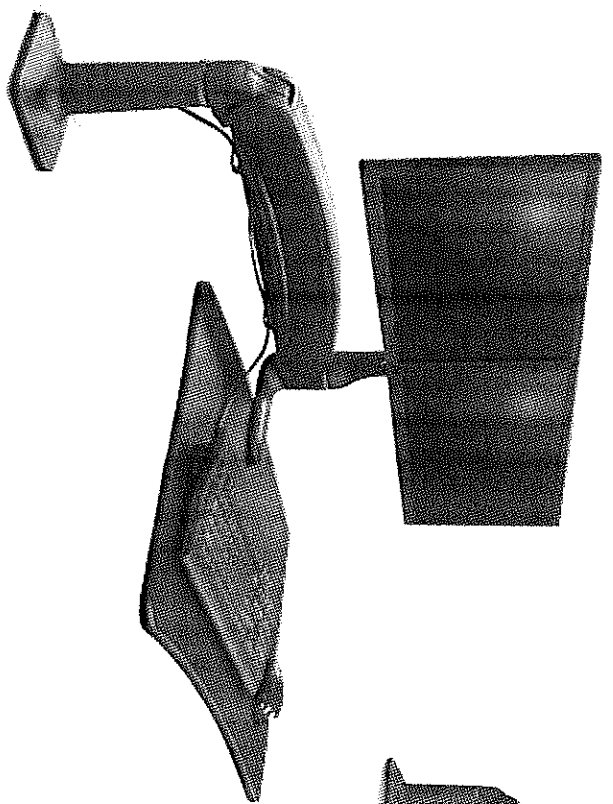

The Co-Pilot has 18.5" of gas assisted height adjustment. To maximize the use of the desk surface, the work surface can also be swung to the side when not in use.

SYMMETRY / CO-PILOT

*Attaches to existing desktop – Clamp or Bolt Mounted

<http://www.symmetryoffice.com/products/9/660/>

Silver or Black

Co-Pilot Single total weight capacity is 24.5lbs
Co-Pilot Dual total weight capacity is 19.5lbs

5 Year Warranty

Single Monitor	\$385.70
Freight	\$48.00 ea
Double Monitor	\$445.08
Freight	\$56.00 ea
Installation	\$55

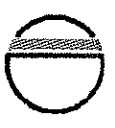

HEIGHT ADJUSTABLE / DESK MOUNTED

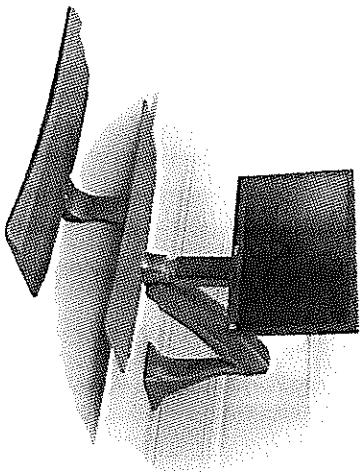
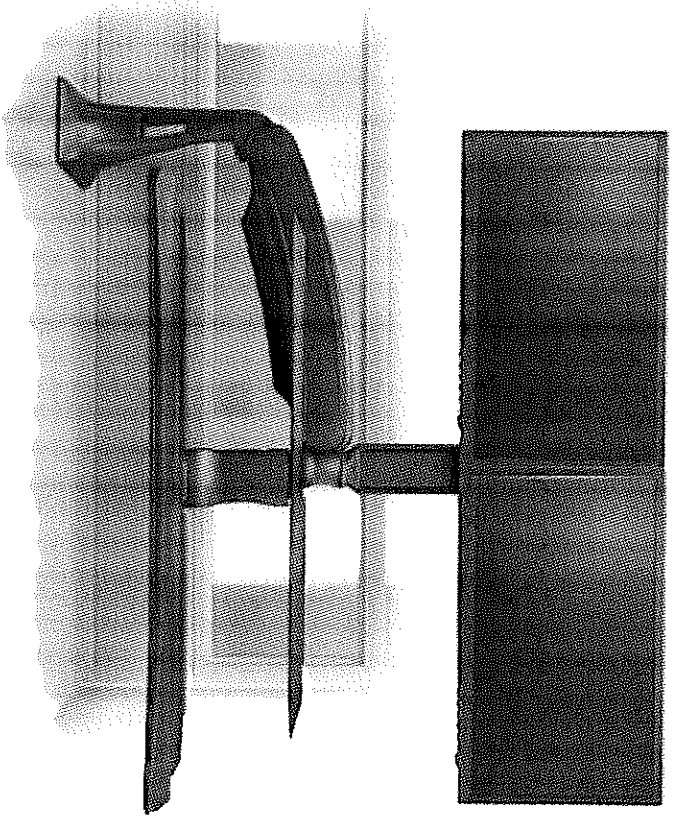

The Pilot has 22" of gas assisted height adjustment as well as an independent height adjustable mechanism for the keyboard tray.

SYMMETRY / PILOT

**Attaches to existing desktop - Clamp or Bolt Mounted*

<http://www.symmetryoffice.com/products/9/524/>

Silver, White or Black

Pilot Single total weight capacity is 25lbs
Pilot Dual total weight capacity is 16lbs

5 Year Warranty

Single Monitor	\$526.30
Freight	\$66.00 ea
Double Monitor	\$594.70
Freight	\$75.00 ea
Installation	\$55



HEIGHT ADJUSTABLE / DESK MOUNTED

QuickStand Lite features an innovative counterbalance mechanism that enables users of varying heights to transition from sitting to standing positions with ease, offering 20" of total height range and an added 5.5" of vertical monitor adjustment. Its effortless functionality encourages users to be active throughout the day.

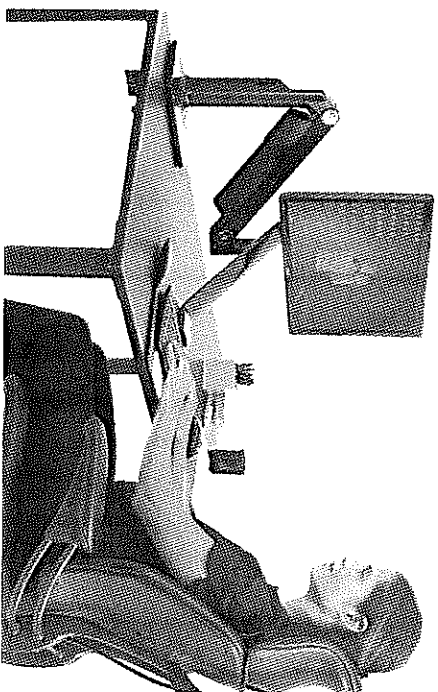
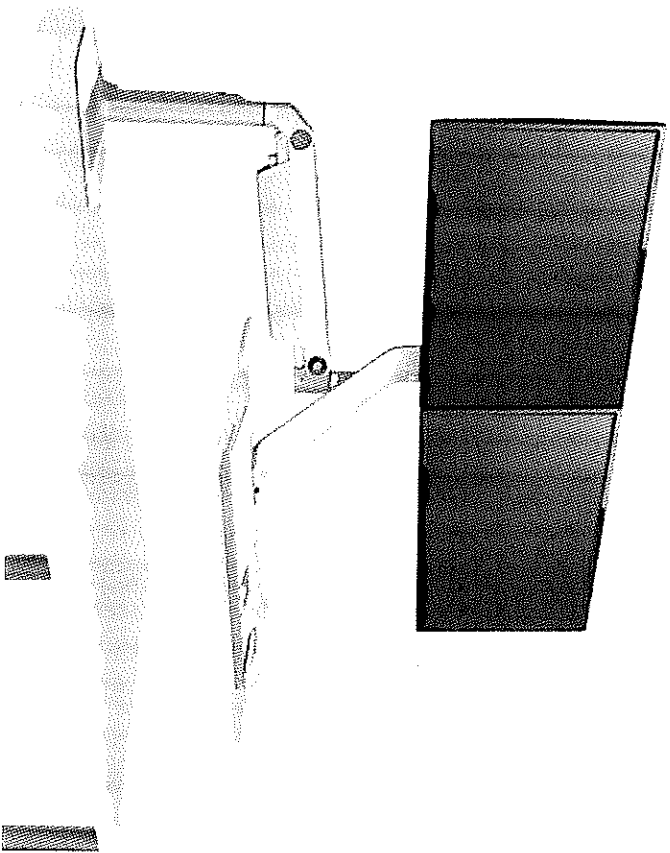

HUMANSCALE / QUICKSTAND LITE

*Attaches to existing desktop – Clamp or Bolt Mounted

<https://www.humanscale.com/products/product.cfm?group=quickstandlite>

Silver or Black

Weight capacity is 22lbs

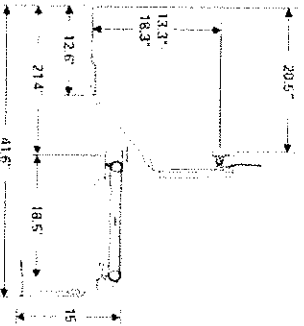

Light Single Monitor	\$399.03
Heavy Single Monitor	\$422.53
Light Double Monitor	\$446.03
Wide Double Monitor	\$455.43
Freight	4% of sell price
Installation	\$55

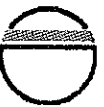

HEIGHT ADJUSTABLE / DESK MOUNTED

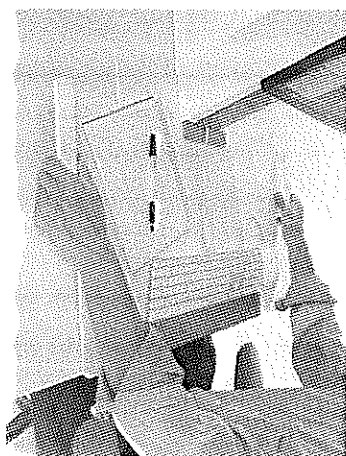
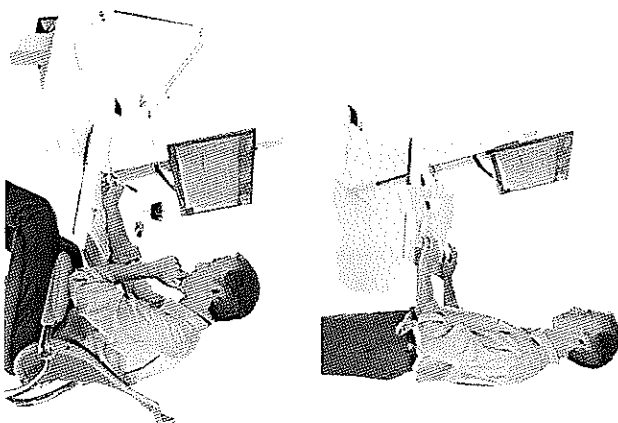
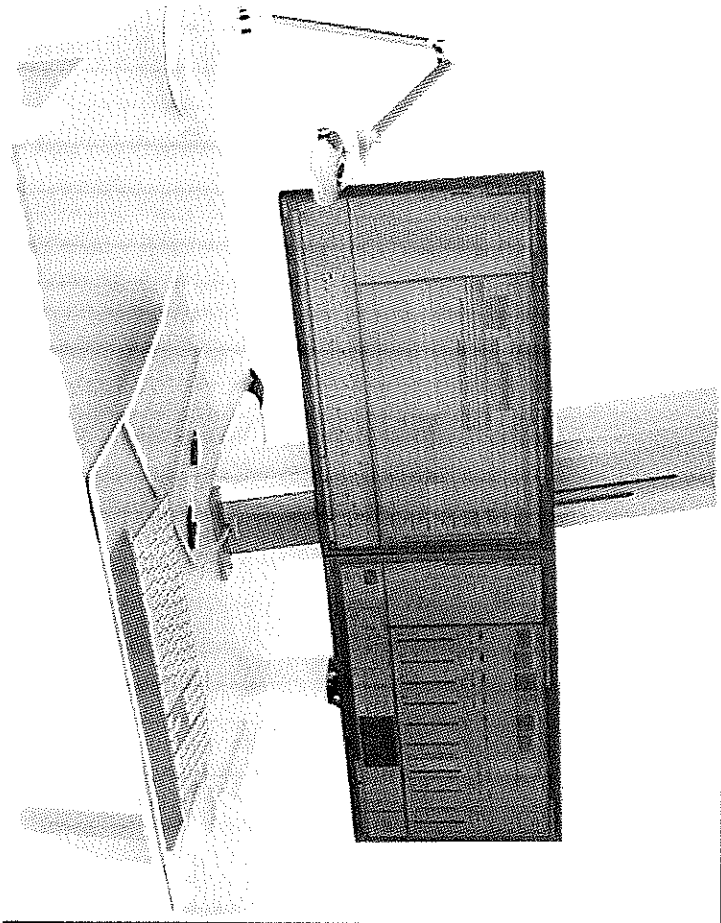

HUMANSCALE / QUICKSTAND

*Attaches to existing desktop - Clamp or Bolt Mounted
(Also available as a freestanding base)

<https://www.humanscale.com/products/product.cfm?grou>

Black or White

Monitors up to 30lbs

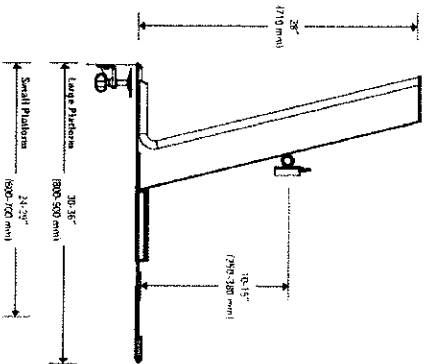

Single Lite, Small Platform	\$420.18
Single Lite, Large Platform	\$443.68
Single Heavy, Small Platform	\$467.18
Single Heavy, Large Platform	\$490.68
Standard Double, Small Platform	\$490.68
Standard Double, Large Platform	\$514.18
Wide Double, Small Platform	\$500.08
Wide Double, Large Platform	\$523.58
Freight	4% of sell price
Installation	\$55

HEIGHT ADJUSTABLE / DESK MOUNTED

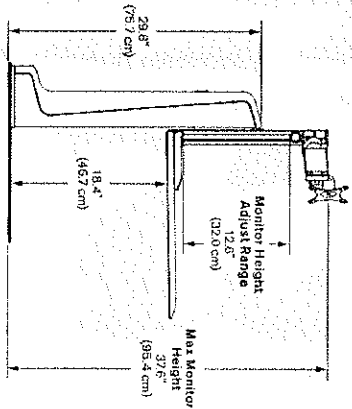
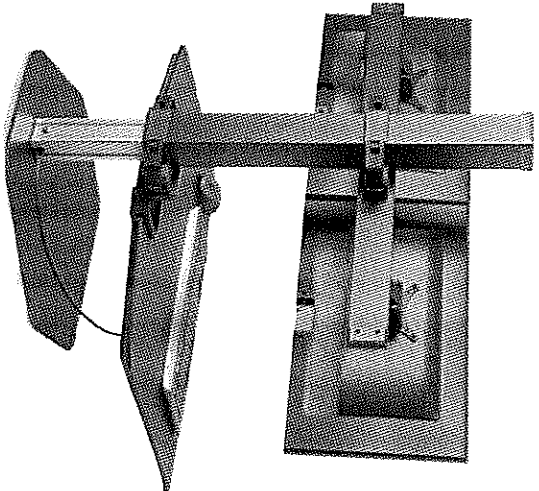
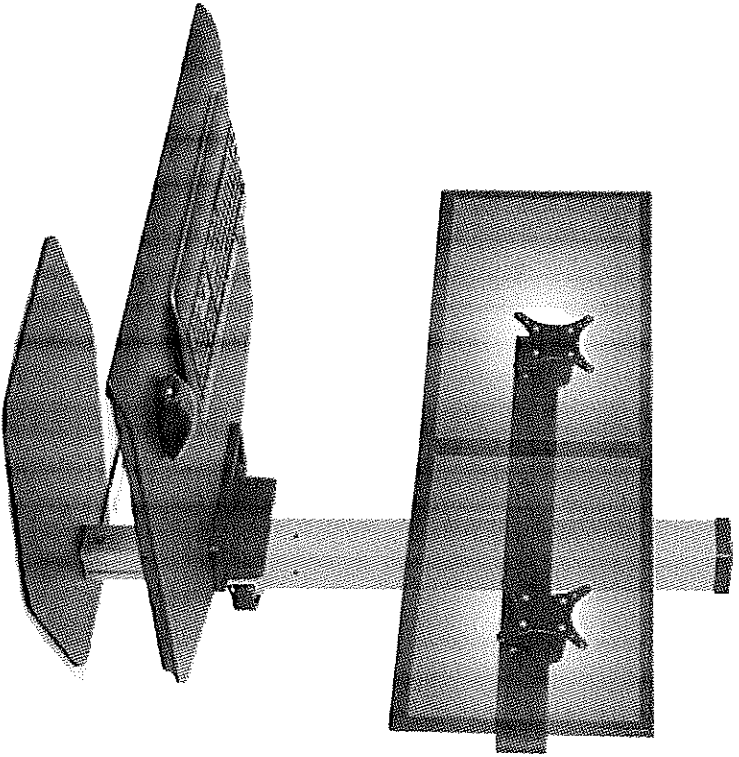

INNOVATIVE / WINSTON Sit-Stand Workstation

Single, Dual or Triple Monitors

<http://innovativeworkspaces.com/product/winston-dual-freestand/>

Black, White or Silver

Monitors up to 26lbs total

Single Monitor	\$436.50
Double Monitor	\$459.00
Triple Monitor	\$549.00
Freight	\$57.00 ea
Installation	\$75

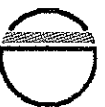

MONITOR ARMS

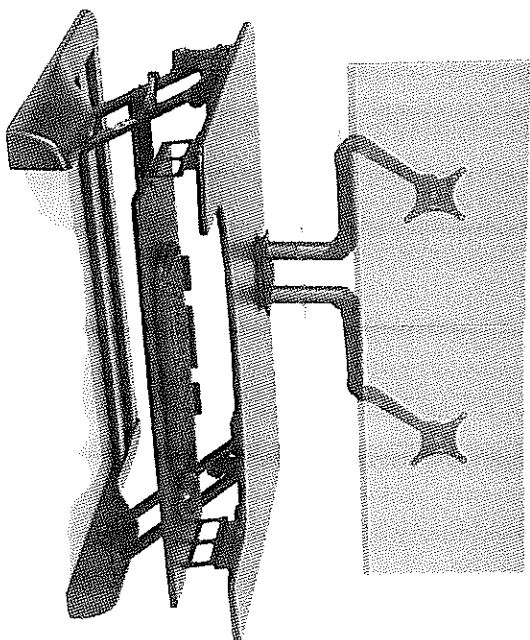
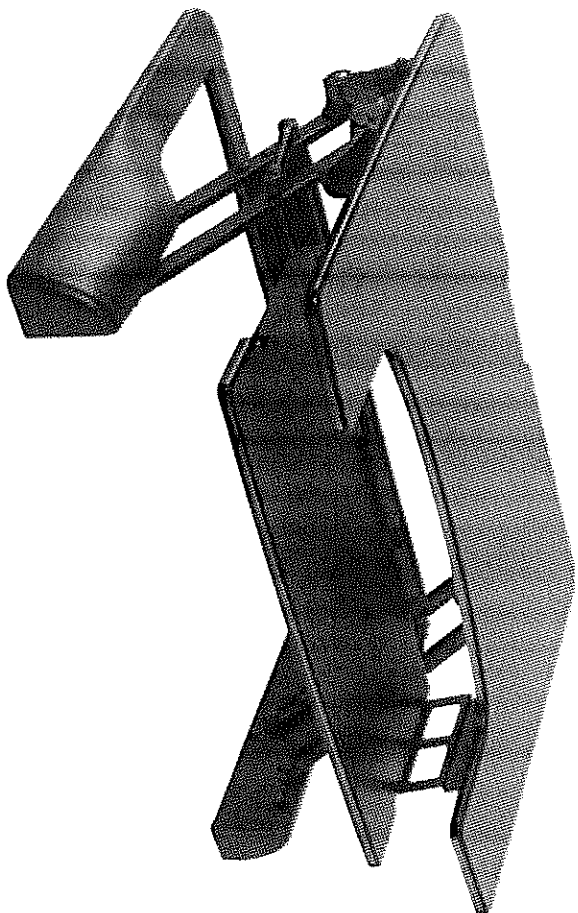

INNOVATIVE / FREEDOM DESK

Available in three sizes: 30", 36" and 42".

<http://innovativeworkspaces.com/product/ergotech-freedom-desk/>

Spring assisted to raise and lower in seconds
 Upper desk surface has a 10mm bolt- thru hole for mounting an optional monitor arm.
 Ships fully assembled, no installation required.
 5 Year Warranty
 Black or White

30"W	\$270.00
36"W	\$341.00
42"W	\$315.00
Freight	\$25.00 EACH
Installation	\$55

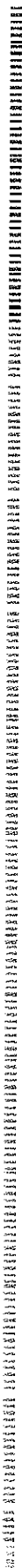

KEYBOARD TRAYS

6G90090HG22	\$167.40
Installation	\$55

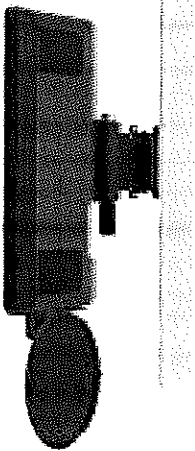

6FB500-F2714	\$127.08
Installation	\$55

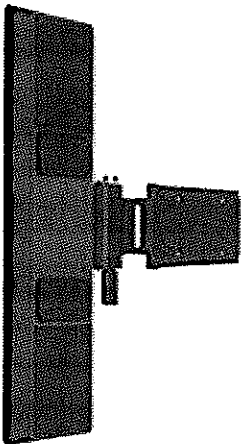

SOLUTIONULTRA	\$211.38
Installation	\$55

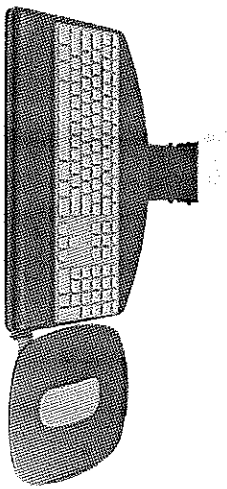

HUMANSCALE / KEYBOARD TRAY
6G90090HG22

https://www.humanscale.com/products/category_data_ll.cfm?category=keyboard_systems

- Black
- Standard Mechanism / Platform
- 9" Clip Mouse High
- 19" Foam Palm Support w/ Synthetic Leather Cover
- 22" Track Length

HUMANSCALE / KEYBOARD TRAY
(for Height Adjustable Workspaces)
6FB500-F2714

https://www.humanscale.com/products/category_detail.cfm?category=keyboard_systems

- Black
- Standard Mechanism for Height Adjustable Surfaces
- Big Platform
- No Mouse Platform
- 27" Foam Palm Support w/ Synthetic Leather Cover
- 14" Track Length

ESI / KEYBOARD TRAY
SOLUTIONULTRA

<https://www.esiergo.com/keyboard-solutions/combo-solutions/sp/solution-ultra/>

- PL217 SWITCH-N-CLICK PLATFORM**
- 18.75" keyboard platform
- 9.25" Switch-n-Click mousing platform
- Designed to complement radius corner work surfaces and position the keyboard closer to the work area.

- AA360 ARTICULATING ARM**
- 21" glide track, Lift and Lock
- 7" height adjustment
- High: 2.5" above track
- Low: 4.5" below track

*Installation labor to be quoted as required, including vendor to perform a site visit to measure and determine proper needs of the workspace.

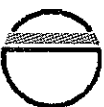
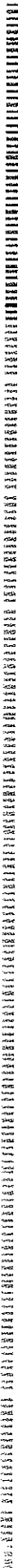

MONITOR ARMS

DOUBLE MONITOR ARM

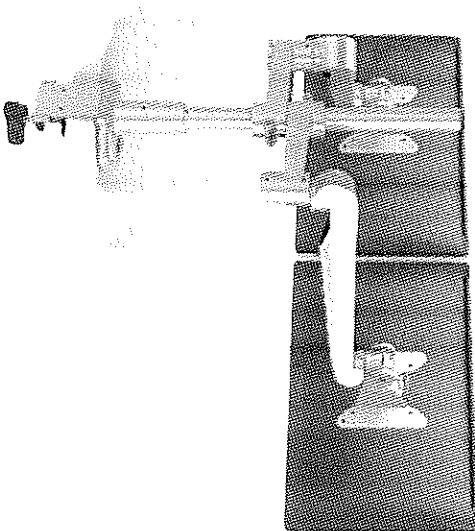

SINGLE MONITOR ARM

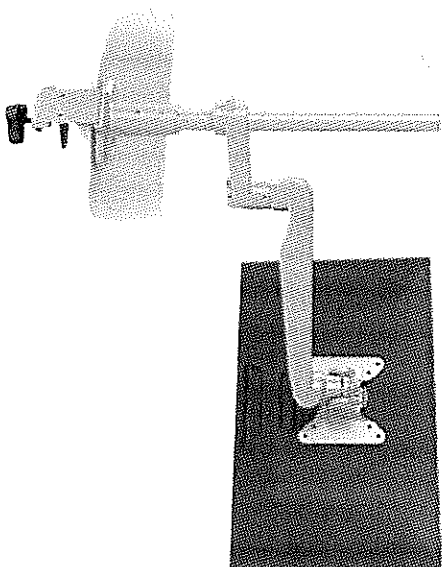

ESI / EVOLVE-F

<https://www.esiergo.com/monitor-arms/dual/splevolve2-fl>

Single and Dual Monitor Arm.
Manual Height Adjustment.

- Monitor Extension: 16.25"
- Monitor Retraction: 3"
- Monitor Tilt: +90°/-25°
- Monitor Rotation: +90°/-90°
- Weight Capacity (per arm):
Maximum: 20 lbs
- 180° Lock-Out Feature
- Quick Release
- 16" Pole
- Desk clamp & grommet mount included
- Max Monitor Width: 27" (bezel measured left to right)

Single Monitor Arm	\$142.03
Double Monitor Arm	\$228.48
Freight	\$25.00 ea
Installation	\$55

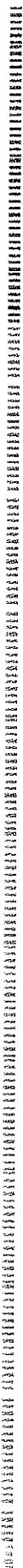

MONITOR ARMS

M2CS2S	\$171.26
Installation	\$55

*Installation labor to be quoted as required, including vendor to perform a site visit to measure and determine proper needs of the workspace.

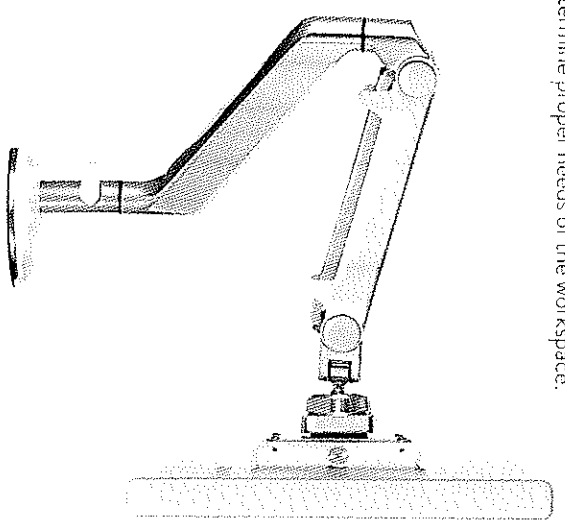

HUMANSCALE / M2 SINGLE

M2CS2S

<https://www.humanscale.com/products/product.cfm?group=M2>

Articulating Arm w/ Spring Tension Technology
 Silver, Polished Aluminum or Black
 Desk Clamp Mount OR Bolt Through Mount
 Fixed Straight Link / Dynamic Link Arm Style
 Standard VESA Plate

SINGLE	\$139.68
DOUBLE	\$244.80
Installation	\$55

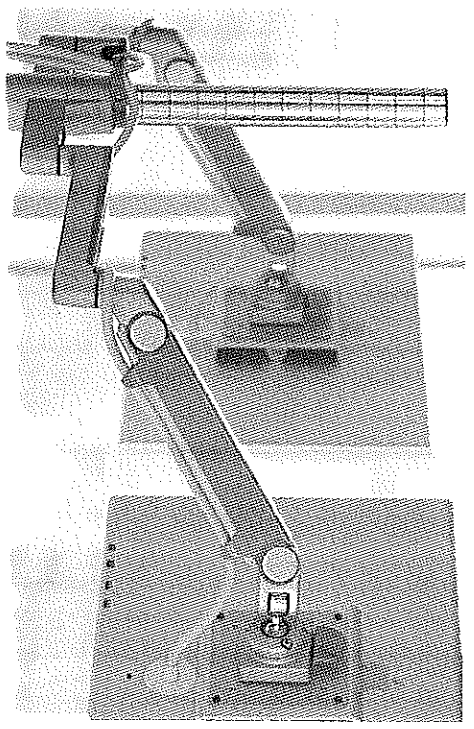

HUMANSCALE / MFLEX

*Single or Double

MF2S2B12 // MF2S22B12

<https://www.humanscale.com/products/product.cfm?group=M2>

Articulating Arm w/ Spring Tension Technology
 Silver, Polished Aluminum or Black
 Bolt Through Mount (Clamp optional w/ upcharge)
 Fixed Straight Link / Dynamic Link Arm Style
 12"H Post
 Standard VESA Plate

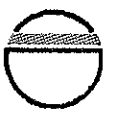
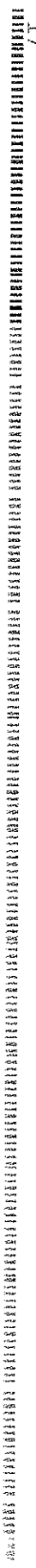

COMPANY PROFILE

VALUES

EXCELLENT

Office Interiors & Design is committed to excellence in all aspects of interior design and furniture products and services; in communication, space planning and design, CAD drawing, furniture specification, finish selection, order placement, receiving, warehousing, installation and client wrap-up; in the hiring of the absolute best people and continuing professional development of everyone; in all administrative policies and procedures; and participation in the communities that fuel the continual reinvigoration of the interior design community.

LISTENING

Remaining ever mindful that each client is a unique individual or group, with unique and specific requirements, the employees of OI&D are committed to sharing the client vision; through active listening, providing thoughtful, individualized solutions, and remaining flexible of mind, the shared vision is attained.

STEWARDSHIP

As a mid-western, family owned company we recognize that our company's strength comes from our people; and that our people come from our community. OI&D is committed to fostering a love of design in young people and we pledge to continue to support local design students and curricula.

KNOWLEDGE

OI&D has extensive experience and product expertise across many markets; including corporate, government, public spaces, technology and higher education. From top to bottom, we understand the specific markets we serve.

We utilize the latest technology to accommodate client needs quickly. Planning, specifications, ordering and tracking orders are managed in a way that ensures speed and accuracy.

PEOPLE

We pride ourselves on the knowledge, expertise and professionalism of our entire company. Many of our employees have been with the company for over 15 years, and we are continually honored with an incredible employee retention rate as well as a commitment to ongoing training.

Our service team is comprised of extremely dependable and professional individuals that continue to reinforce the positive experience of working with our company.

MISSION

Office Interiors & Design, Inc. is a full-service commercial furniture dealership dedicated to delivering an enjoyable, professional client experience; ever-striving to realize the client vision while strictly adhering to budget and schedule.

OI&D was founded by Dian Pickerel in 1995 and remains a family-owned, women-owned business.

OI&D is a client-first company that positions itself for long-term success by committing to client delight.

OI&D is pledged to excellence of client experience and creating the amazing spaces of our client's vision and that the design, administrative and installation teams are trained experts; ready to assist clients in all phases of the process, communicate effectively, and create solutions.

Office Interiors & Design intends that its clients achieve all of their project goals and are delighted by the process and results.

VISION

Office Interiors & Design, Inc. is a preeminent regional commercial furniture dealership, where the furniture experience transforms every client into an earnest, vocal advocate of our firm.

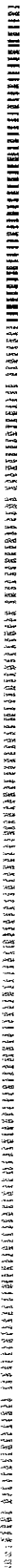

SERVICES

OID is a single source resource for all commercial furniture needs across of variety of markets. We support clients from space planning through furniture assembly and move in, as well as post occupancy needs. It's our job to take the hassle out of creating smart furniture solutions.

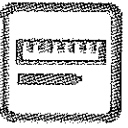

DESIGN

We offer full design services including workplace strategy, typical development, 3D renderings, space planning, technical specification, fabric and finish selections, installation drawings and field verification.



CUSTOMIZATION

We help our clients achieve a vision that also fits with their organizations branding and goals. Our manufacturer partners allows us to customize everything from colors, finishes, fabrics, furniture design, and more. Each product is truly designed to order the way you want it.



PRODUCT SOLUTIONS

As workplace design and project management specialists, we help create and refine your vision for the office. We provide idea starters, full floor plan product selections, and offerings that fit within your budget.



PROJECT MANAGEMENT

Our experienced Project Leads provide you one point of contact to tailor your project to specific budget and schedule needs. Dedicated Project Leads guide you through every step including planning, installation and revisions.

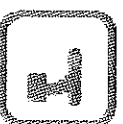

INSTALLATION

We outline your schedule and communication plan, and our team will oversee the production and installation processes to ensure they run smoothly. We are committed to finishing well through our team, and our partner installers, of courteous, prompt and professional installers.



City of Lincoln/Lancaster County (Lincoln Purchasing) Supplier Response

Bid Information		Contact Information		Ship to Information
Bid Creator	Rachelle Hinze, Buyer	Address	Purchasing	Address
Email	rhinze@lincoln.ne.gov		440 S. 8th St.	
Phone	1 (402) 441-8313		Lincoln, NE 68508	
Fax	1 (402) 441-6513	Contact	Rachelle Hinze, Buyer	Contact
Bid Number	17-140	Department		Department
Title	Annual Supply - Workstations and Accessories	Building		Building
Bid Type	Bid		Suite 200	
Issue Date	5/15/2017 09:01 AM (CT)	Floor/Room		Floor/Room
Close Date	6/2/2017 12:00:00 PM (CT)	Telephone	1 (402) 441-8313	Telephone
		Fax	1 (402) 441-6513	Fax
		Email	rhinze@lincoln.ne.gov	Email

Supplier Information

Company AOI (AOI Corporation)
 Address 8320 Cody Dr

 Lincoln, NE 68512
 Contact Pam Leupold
 Department
 Building
 Floor/Room
 Telephone (402) 560-3866
 Fax
 Email pleupold@aoicorp.com
 Submitted 6/1/2017 01:12:27 PM (CT)
 Total \$0.00

By submitting your response, you certify that you are authorized to represent and bind your company.

Signature Ryan Stanbrough

Email rstanbrough@aoicorp.com

Supplier Notes

Lead Times are typically 5-7 weeks but may vary across the options proposed.

Bid Notes

Bid Activities

Bid Messages

Bid Attributes

Please review the following and respond where necessary

#	Name	Note	Response
1	U.S. Citizenship Attestation	<p>Is your company legally considered an Individual or Sole Proprietor: YES or NO</p> <p>As a Vendor who is legally considered an Individual or a Sole Proprietor I hereby understand and agree to comply with the requirements of the United States Citizenship Attestation Form, available at: http://www.sos.ne.gov/business/notary/citizenforminfo.html</p> <p>All awarded Vendors who are legally considered an Individual or a Sole Proprietor must complete the form and submit it with contract documents at time of execution.</p> <p>If a Vendor indicates on such attestation form that he or she is a qualified alien, the Vendor agrees to provide the US Citizenship and Immigration Services documentation required to verify the Vendor's lawful presence in the United States using the Systematic Alien Verification for Entitlements (SAVE) Program.</p> <p>Vendor further understands and agrees that lawful presence in the United States is required and the Vendor may be disqualified or the Contract terminated if such lawful presence cannot be verified as required by Neb. Rev. Stat. 4-108.</p>	No
2	Bid Documents	I acknowledge and accept that it is my responsibility as a Bidder to promptly notify the Purchasing Department Staff prior to the close of the bid of any ambiguity, inconsistency or error which I may discover upon examination of the bid documents including, but not limited to the Specifications.	Yes
3	Instructions to Bidders	I acknowledge reading and understanding the Instructions to Bidders.	Yes
4	Insurance Requirements and Endorsements	<p>Vendor agrees to provide insurance coverage for each checked box on the Insurance Clause document in the Bid Attachments including the submission of the Certificate of ACORD and the applicable endorsements:</p> <p>Insurance Certificate and required Endorsements are required at time of contract execution by the vendor.</p> <p>Vendors are strongly encouraged to send the insurance requirements and endorsement information to their insurance agent prior to bid close in order to expedite the contract execution process.</p>	Yes
5	Special Provision Term Contract Provisions	I acknowledge reading and understanding the Special Provision Term Contract Provisions.	Yes
6	Quantities	I acknowledge that the quantities listed for each line item are an estimated yearly amount. The City does not guarantee any dollar amount or order quantities for the term of the contract.	Y
7	Brochure/Specifications	I acknowledge that I have attached the brochure/specifications of the product(s) I am bidding.	Yes
8	Sample Contract	I acknowledge reading and understanding the sample contract.	Yes

- | | | | |
|----|---|--|--|
| 9 | Specifications | I acknowledge reading and understanding the specifications. | Yes |
| 10 | Term Clause of Contract | I acknowledge that the term of the contract is for a one (1) year term with the option for three (3) additional one (1) year renewals from the date of the executed contract. (a) Are your bid prices firm for the first one (1) year contract period. YES or NO
(b) Are your bid prices subject to escalation/de-escalation YES or NO
(c) If (b), state period for which prices will remain firm: through _____ | (a) YES |
| 11 | Purchase Order, Contract and Delivery Contact | The City/County Purchasing Department issues Purchase Orders and Contracts via email to a designated contact person of the awarded Vendor. This designee will be the primary contact with the department through the delivery of the product/services.
Please list the name, email address and phone number of the person who will be the contact person for the PO to be awarded. | Ryan Stanbrough,
rstanbrough@aoicorp.com,
402-980-4565 |
| 12 | Contract and Delivery Contact | The City/County Purchasing Department will issue a Contract via email to a designated contact person of the awarded Vendor. This designee will be the primary contact with the department through the delivery of the product/services.
Please list the name, email address and phone number of the person who will be the contact person for the PO to be awarded. | Ryan Stanbrough,
rstanbrough@aoicorp.com,
402-980-4565 |
| 13 | Contact | Name of person submitting this bid: | Ryan Stanbrough |
| 14 | Electronic Signature | Please check here for your electronic signature. | Yes |

Line Items

#	Qty	UOM	Description	Response
1	1	EA	This is to notify you that Bid 17-140 for Sit to Stand Workstations and Accessories is available. Please prepare your written response and attach your proposals as instructed in the specifications. Respond to the Attribute section (above) of this electronic bid and submit before the closing date and time. Also, you are required to enter a 0 for your response in this line item. If you have any questions, call 402-441-8313.	\$0.00

Item Notes:

Supplier Notes:

Response Total: \$0.00

Rachelle J. Hinze

From: Ryan Stanbrough <rstanbrough@aoicorp.com>
Sent: Friday, June 16, 2017 5:07 PM
To: Rachelle J. Hinze
Subject: RE: Bid 17-140 Workstations and Accessories
Attachments: HM_AltissimoPrimeBrochure.pdf; PB_THR.pdf

Rachelle,

I've attached the brochures for the products that are newer and not yet on a website. For the majority I've included links to the websites due to the size of the email this would be to include all of the brochures;

- AOI Installation
 - Line #1 = Delivery and Installation of 1 Height Adjustable Table/Base
 - Line #2 = Delivery and Installation of 1 Sit-to-Stand Workstation
 - Line #3 = Delivery and Installation of 1 Monitor Arm
 - Line #4 = Delivery and Installation of 1 Keyboard Tray
 - Line #5 = Delivery and Installation of 1 Wall-Mounted Tech Station

Herman Miller Products

- Herman Miller – Renew Height Adjustable Tables/Bases <http://www.hermanmiller.com/products/tables/conference-tables/renew-sit-to-stand-tables.html>
 - Lines #6-7 = Height Adjustable Base Only, brochure - http://www.hermanmiller.com/content/dam/hermanmiller/documents/product_literature/brochures/renew_sit-to-stand_tables_brochure.pdf
 - Lines #12-15 = Height Adjustable Base and Surface, brochure - http://www.hermanmiller.com/content/dam/hermanmiller/documents/product_literature/brochures/renew_sit-to-stand_tables_brochure.pdf
- Herman Miller – Motia Height Adjustable Tables/Bases <http://www.hermanmiller.com/products/tables/sit-to-stand-tables/motia-sit-to-stand-tables.html>
 - Lines #8-11 = Height Adjustable Base Only, brochure - http://www.hermanmiller.com/content/dam/hermanmiller/documents/product_literature/brochures/motia_sit_to_stand_tables_brochure.pdf
 - Lines #16-19 = Height Adjustable Base and Surface, brochure - http://www.hermanmiller.com/content/dam/hermanmiller/documents/product_literature/brochures/motia_sit_to_stand_tables_brochure.pdf
- Herman Miller – Keyboard Trays <http://www.hermanmiller.com/products/accessories/technology-support/keyboard-supports.html>
 - Line #20 = LS Series Keyboard Solution, brochure - http://www.hermanmiller.com/content/dam/hermanmiller/documents/product_literature/product_sheets/ls_keyboard_support_product_sheet.pdf
 - Line #21 = LT Series Keyboard Solution, brochure - http://www.hermanmiller.com/content/dam/hermanmiller/documents/product_literature/product_sheets/lt_keyboard_support_product_sheet.pdf
 - Line #22 = LX Series Keyboard Solution, brochure - http://www.hermanmiller.com/content/dam/hermanmiller/documents/product_literature/product_sheets/lx_keyboard_support_product_sheet.pdf
 - Line #23 = TL Series Keyboard Solution, brochure - http://www.hermanmiller.com/content/dam/hermanmiller/documents/product_literature/product_sheets/tl_keyboard_support_product_sheet.pdf

- **Herman Miller – Flo Monitor Arms** <http://www.hermanmiller.com/products/accessories/technology-support/flo-monitor-arms.html>
 - **Line #24 = Flo Dual Screen Monitor Arm, brochure -**
http://www.hermanmiller.com/content/dam/hermanmiller/documents/product_literature/brochures/Flo_Monitor_Arm_brochure.pdf
 - **Line #25 = Flo Modular Dual Screen Monitor Arm, brochure -**
http://www.hermanmiller.com/content/dam/hermanmiller/documents/product_literature/brochures/flo_modular_brochure.pdf
 - **Line #26 = Flo Plus Dual Screen Monitor Arm, brochure -**
http://www.hermanmiller.com/content/dam/hermanmiller/documents/product_literature/brochures/Flo_Monitor_Arm_brochure.pdf
 - **Line #27 = Flo Single Screen Monitor Arm, brochure -**
http://www.hermanmiller.com/content/dam/hermanmiller/documents/product_literature/brochures/Flo_Monitor_Arm_brochure.pdf
- **Herman Miller – Altissimo Prime Sit-to-Stand Workstations**
 - **Line #28 = Altissimo Prime Single Monitor, see attached brochure - HM_AltissimoPrimeBrochure.pdf**
 - **Line #29 = Altissimo Prime Dual Monitor, see attached brochure - HM_AltissimoPrimeBrochure.pdf**
- **Herman Miller – Wall-Mounted Tech Stations**
 - **Line #30 = FX40 Compact Wall-Mounted Technology Support:**
<http://www.hermanmiller.com/products/accessories/technology-support/wall-mounted-technology-fx-series.html>
 - **Line #31 = HD Wall-Mounted Technology Slider Platform:**
<http://www.hermanmiller.com/products/accessories/technology-support/wall-mounted-technology-hd-series.html>
 - **Line #32 = Mbrace Wall-Mounted Technology Support:**
<http://www.hermanmiller.com/products/accessories/technology-support/mbrace-wall-mounted-technology.html>
- **Herman Miller – Palm Rests**
 - **Line #33 = Palm Rest for Keyboard Tray, see page 93 of:**
http://www.hermanmiller.com/content/dam/hermanmiller/documents/pricing/PB_THR.pdf
 - **Line #34 = Freestanding Palm Rest, see page 92 of:**
http://www.hermanmiller.com/content/dam/hermanmiller/documents/pricing/PB_THR.pdf
 - **Line #35 = Palm Rest for Input Device Platform, see page 94 of:**
http://www.hermanmiller.com/content/dam/hermanmiller/documents/pricing/PB_THR.pdf

Humanscale Products

- **Humanscale – Keyboard Trays** <https://www.humanscale.com/products/product.cfm?group=KeyboardSystems>
 - **Line #36 = 6G.900.90 Keyboard Tray, brochure -**
https://www.humanscale.com/userfiles/file/KeyboardBrochure_0611.pdf
 - **Line #37 = 6FB.500 Keyboard Tray, brochure -**
https://www.humanscale.com/userfiles/file/KeyboardBrochure_0611.pdf
- **Humanscale – Monitor Arms**
https://www.humanscale.com/products/category_detail.cfm?category=monitorarms
 - **Line #38 = M8 Dual Monitor Arm, brochure -**
https://www.humanscale.com/userfiles/file/M8_brochure_071813.pdf
 - **Line #39 = MFlex for M2 Dual Monitor Arms, brochure -**
https://www.humanscale.com/userfiles/file/M8_brochure_071813.pdf
 - **Line #40 = M2 Single Monitor Arm, brochure -**
https://www.humanscale.com/userfiles/file/m2_brochure_071813.pdf
 - **Line #41 = M8 Single Monitor Arm, brochure -**
https://www.humanscale.com/userfiles/file/M8_brochure_071813.pdf

- Humanscale – Float Height Adjustable Tables/Bases
<https://www.humanscale.com/products/product.cfm?group=float>
 - Line #42-43 = Float Height Adjustable Table Base Only, brochure -
https://www.humanscale.com/userfiles/file/Float_Brochure_0814.pdf
 - Line #45-49 = Float Height Adjustable Base and Surface, brochure -
https://www.humanscale.com/userfiles/file/Float_Brochure_0814.pdf
- Humanscale – eFloat Height Adjustable Tables/Bases
<https://www.humanscale.com/products/product.cfm?group=eFloat>
 - Line #44 = eFloat Height Adjustable Table Base Only, brochure -
https://www.humanscale.com/userfiles/file/eFloat_Brochure_081016.pdf
 - Line #50-59 = eFloat Height Adjustable Table Base and Surface, brochure -
https://www.humanscale.com/userfiles/file/eFloat_Brochure_081016.pdf
- Humanscale – QuickStand Sit-to-Stand Workstations
<https://www.humanscale.com/products/product.cfm?group=quickstand>
 - Line #60 = QuickStand Single Monitor, brochure -
https://www.humanscale.com/userfiles/file/quickstand_brochure_0814.pdf
 - Line #61 = QuickStand Dual Monitor Standard Crossbar, brochure -
https://www.humanscale.com/userfiles/file/quickstand_brochure_0814.pdf
 - Line #62 = QuickStand Dual Monitor Wide Crossbar, brochure -
https://www.humanscale.com/userfiles/file/quickstand_brochure_0814.pdf
- Humanscale – QuickStand Lite Sit-to-Stand Workstations
<https://www.humanscale.com/products/product.cfm?group=quickstandlite>
 - Line #63 = QuickStand Lite Single Monitor, brochure -
https://www.humanscale.com/userfiles/file/quickstandlite_brochure_1215.pdf
 - Line #64 = QuickStand Lite Dual Monitor, brochure -
https://www.humanscale.com/userfiles/file/quickstandlite_brochure_1215.pdf

If there are any questions just let me know and I'd be happy to walk through any of this in person if you'd prefer.

Thanks!

Ryan Stanbrough
(c) 402.980.4565

From: Rachelle J. Hinze [mailto:rhinze@lincoln.ne.gov]
Sent: Friday, June 16, 2017 8:46 AM
To: Ryan Stanbrough <rstanbrough@aoicorp.com>
Subject: RE: Bid 17-140 Workstations and Accessories

Do you have a catalog that you could send with each of the items you bid numbered 1-64 so I can see what you are bidding?

City of Lincoln Purchasing - Rachelle Hinze, Buyer
402-441-8313

AOI

Furniture Proposal

Quote Number 12249
 Project Number
 Date 06/01/2017
 Customer PO Number
 Customer Account CITLIN
 Account Manager Ryan Stanbrough
 Page 1 of 14

BILL TO
 City of Lincoln
 555 S 10 St
 AP / AR
 Lincoln, NE 68508

INSTALL AT
 City of Lincoln
 555 S 10 St
 AP / AR
 Lincoln, NE 68508

ATTN: Rachelle Hinze
 Phone: 402.441.8313
 Email: rhinze@lincoln.ne.gov

ATTN: Rachelle Hinze
 Phone: 402.441.8313
 Email: rhinze@lincoln.ne.gov

- Lines 1-5: Installation Prices for Individual Units
- Lines 6-11: Herman Miller-Height Adjustable Bases
- Lines 12-19: Herman Miller-Height Adjustable Tables
- Lines 20-23: Herman Miller-Keyboard Trays
- Lines 24-27: Herman Miller-Monitor Arms
- Lines 28-29: Herman Miller-Sit to Stand Workstations
- Lines 30-32: Herman Miller-Wall Mounted Workstations
- Lines 33-35: Herman Miller-Wrist Rests
- Lines 36-37: Humanscale-Keyboard Trays
- Lines 38-41: Humanscale-Monitor Arms
- Lines 42-44: Humanscale-Height Adjustable Bases
- Lines 45-59: Humanscale-Height Adjustable Tables
- Lines 60-64: Humanscale-Sit to Stand Workstations

Line	Quantity	Description	Unit Price	Extended Amount
1	1.00 Each	D&I-AOI Installation LABOR Labor to receive, deliver, and install 1-Height Adjustable Table	125.00	125.00
2	1.00 Each	D&I-AOI Installation LABOR Labor to receive, deliver, and install 1-Sit to Stand Workstation	125.00	125.00
3	1.00 Each	D&I-AOI Installation LABOR Labor to receive, deliver, and install 1-Monitor Arm	70.00	70.00
4	1.00 Each	D&I-AOI Installation LABOR Labor to receive, deliver, and install 1-Keyboard Tray	70.00	70.00
5	1.00 Each	D&I-AOI Installation LABOR Labor to receive, deliver, and install 1-Wall-Mounted Tech Station	125.00	125.00
6	1.00 Each	Herman Miller DU7A.E24C--NNP-SUD-G2-57 @Table Base Kit - 2 Legs, Elec Std Range, 24D, C Foot Type NNP:@no power access SUD:@simple up down G2:@graphite satin leg with graphite satin foot	984.96	984.96

AOI

Furniture Proposal

Quote Number 12249
 Project Number
 Date 06/01/2017
 Customer PO Number
 Customer Account CITLIN
 Account Manager Ryan Stanbrough
 Page 2 of 14

		57:@glides Mark Line For: Tag L1: Hgt Adj Base		
7	1.00 Each	Herman Miller DU7A.E30C--NNP-SUD-G2-57 @Table Base Kit - 2 Legs, Elec Std Range, 30D, C Foot Type NNP:@no power access SUD:@simple up down G2:@graphite satin leg with graphite satin foot 57:@glides Mark Line For: Tag L1: Hgt Adj Base	984.96	984.96
8	1.00 Each	Herman Miller DV7AT.2448E--STS-G2-57 @Hgt Adj Base Kit w/T-Foot, Elec Std Range, 24D 48W STS:@simple up/down touch switch G2:@graphite satin leg with graphite satin foot 57:@glides Mark Line For: Tag L1: Hgt Adj Base	596.60	596.60
9	1.00 Each	Herman Miller DV7AT.2472E--STS-G2-57 @Hgt Adj Base Kit w/T-Foot, Elec Std Range, 24D 72W STS:@simple up/down touch switch G2:@graphite satin leg with graphite satin foot 57:@glides Mark Line For: Tag L1: Hgt Adj Base	619.40	619.40
10	1.00 Each	Herman Miller DV7AT.3048E--STS-G2-57 @Hgt Adj Base Kit w/T-Foot, Elec Std Range, 30D 48W STS:@simple up/down touch switch G2:@graphite satin leg with graphite satin foot 57:@glides Mark Line For: Tag L1: Hgt Adj Base	608.00	608.00
11	1.00 Each	Herman Miller DV7AT.3072E--STS-G2-57 @Hgt Adj Base Kit w/T-Foot, Elec Std Range, 30D 72W STS:@simple up/down touch switch G2:@graphite satin leg with graphite satin foot 57:@glides Mark Line For: Tag L1: Hgt Adj Base	630.80	630.80
12	1.00 Each	Herman Miller DU6ACS.2448LE--NNP-SUD-98-98-G2-PSC-NNN-57 @Renew Rect Tbl, C-Foot,Sq-Edge,Lam Top/Thermo Edge,Elec Std NNP:@no power access SUD:@simple up down 98:@studio white 98:@studio white G2:@graphite satin leg with graphite satin foot	1,058.68	1,058.68



Furniture Proposal

Quote Number 12249
 Project Number
 Date 06/01/2017
 Customer PO Number
 Customer Account CITLIN
 Account Manager Ryan Stanbrough
 Page 3 of 14

		PSC:@simple cable NNN:@no cutout 57:@glides Mark Line For: Tag L1: Hgt Adj Table		
13	1.00 Each	Herman Miller DU6ACS.2472LE--NNP-SUD-98-98-G2-PSC-NNN-57 @Renew Rect Tbl, C-Foot,Sq-Edge,Lam Top/Thermo Edge,Elec Std NNP:@no power access SUD:@simple up down 98:@studio white 98:@studio white G2:@graphite satin leg with graphite satin foot PSC:@simple cable NNN:@no cutout 57:@glides Mark Line For: Tag L1: Hgt Adj Table	1,155.20	1,155.20
14	1.00 Each	Herman Miller DU6ACS.3048LE--NNP-SUD-98-98-G2-PSC-NNN-57 @Renew Rect Tbl, C-Foot,Sq-Edge,Lam Top/Thermo Edge,Elec Std NNP:@no power access SUD:@simple up down 98:@studio white 98:@studio white G2:@graphite satin leg with graphite satin foot PSC:@simple cable NNN:@no cutout 57:@glides Mark Line For: Tag L1: Hgt Adj Table	1,111.88	1,111.88
15	1.00 Each	Herman Miller DU6ACS.3072LE--NNP-SUD-98-98-G2-PSC-NNN-57 @Renew Rect Tbl, C-Foot,Sq-Edge,Lam Top/Thermo Edge,Elec Std NNP:@no power access SUD:@simple up down 98:@studio white 98:@studio white G2:@graphite satin leg with graphite satin foot PSC:@simple cable NNN:@no cutout 57:@glides Mark Line For: Tag L1: Hgt Adj Table	1,203.08	1,203.08
16	1.00 Each	Herman Miller DV6ATS.2448LE--STS-1T-98-G2-57 @Rect Table w/T-Foot, Sq-Edge, Lam Top/TP Edge, Elec Std Ran STS:@simple up/down touch switch 1T:@pre-determined top/edge 98:@studio white G2:@graphite satin	682.10	682.10

AOI

Furniture Proposal

Quote Number 12249
 Project Number
 Date 06/01/2017
 Customer PO Number
 Customer Account CITLIN
 Account Manager Ryan Stanbrough
 Page 4 of 14

17	1.00 Each	57:@glides Mark Line For: Tag L1: Hgt Adj Table Herman Miller DV6ATS.2472LE--STS-1T-98-G2-57 @Rect Table w/T-Foot, Sq-Edge, Lam Top/TP Edge, Elec Std Ran STS:@simple up/down touch switch 1T:@pre-determined top/edge 98:@studio white G2:@graphite satin 57:@glides Mark Line For: Tag L1: Hgt Adj Table	763.80	763.80
18	1.00 Each	Herman Miller DV6ATS.3048LE--STS-1T-98-G2-57 @Rect Table w/T-Foot, Sq-Edge, Lam Top/TP Edge, Elec Std Ran STS:@simple up/down touch switch 1T:@pre-determined top/edge 98:@studio white G2:@graphite satin 57:@glides Mark Line For: Tag L1: Hgt Adj Table	723.52	723.52
19	1.00 Each	Herman Miller DV6ATS.3072LE--STS-1T-98-G2-57 @Rect Table w/T-Foot, Sq-Edge, Lam Top/TP Edge, Elec Std Ran STS:@simple up/down touch switch 1T:@pre-determined top/edge 98:@studio white G2:@graphite satin 57:@glides Mark Line For: Tag L1: Hgt Adj Table	825.74	825.74
20	1.00 Each	Herman Miller Y7737.2K--0H +LS Series Keyboard Solutions, 19 Inch Track, 27" HDPE Tray 0H:+black Mark Line For: Tag L1: Keyboard Tray	199.92	199.92
21	1.00 Each	Herman Miller Y7727.1K +LT Series Keyboard Solutions, 19 Inch Track, 27W HDPE Tray Mark Line For: Tag L1: Keyboard Tray	223.38	223.38
22	1.00 Each	Herman Miller Y7724.L +LX Series Keyboard Solutions, 27W HDPE Tray Mark Line For: Tag L1: Keyboard Tray	263.16	263.16
23	1.00 Each	Herman Miller Y7741.2K--0H @TL Series Keyboard Solutions, 19 Track, 27" HDPE Tray 0H:@black	215.22	215.22

AOI

Furniture Proposal

Quote Number 12249
 Project Number
 Date 06/01/2017
 Customer PO Number
 Customer Account CITLIN
 Account Manager Ryan Stanbrough
 Page 5 of 14

24	1.00 Each	Mark Line For: Tag L1: Keyboard Tray Herman Miller Y91175.CM--0I +Flo Dual-Screen Monitor Arm - Surface Clamp Mount 0I:+silver Mark Line For: Tag L1: Monitor Arm-Dual	371.28	371.28
25	1.00 Each	Herman Miller Y91180.152CM--0I @Flo Modular Monitor Arm Assembly,15-3/4H Post,2 Arms,Surf C 0I:@silver Mark Line For: Tag L1: Monitor Arm-Dual	445.23	445.23
26	1.00 Each	Herman Miller Y91174.2CM--0I @Flo Plus Monitor Arm Assembly, Flo Plus Dual, Clamp Mount 0I:+silver Mark Line For: Tag L1: Monitor Arm-Dual	357.00	357.00
27	1.00 Each	Herman Miller Y91171.CM--0I +Flo Sngle-Screen Monitor Arm Support,Surf Clamp 0I:+silver Mark Line For: Tag L1: Monitor Arm-Single	183.09	183.09
28	1.00 Each	Herman Miller Y7800.1--0H @Altissimo Prime Sit-to-Stand Workstation Arm, Single Monito 0H:@black Mark Line For: Tag L1: Sit/Stand Workstation	469.20	469.20
29	1.00 Each	Herman Miller Y7800.2--0H @Altissimo Prime Sit-to-Stand Workstation Arm, Dual Monitor 0H:@black Mark Line For: Tag L1: Sit/Stand Workstation	545.70	545.70
30	1.00 Each	Herman Miller Y94004. @FX40 Compact Wall-mount Technology Support Mark Line For: Tag L1: Wall-Mounted Tech Station	1,174.02	1,174.02
31	1.00 Each	Herman Miller Y94009.48 @HD Wall Mount Technology - Slider Platform, 48" Track Mark Line For: Tag L1: Wall-Mounted Tech Station	1,667.19	1,667.19
32	1.00 Each	Herman Miller Y94015.34--0J @Mbrace Wall-Mounted Technology, 34 Inches Long 0J:@white Mark Line For: Tag L1: Wall-Mounted Tech Station	969.00	969.00
33	1.00	Herman Miller	26.01	26.01

AOI

Furniture Proposal

Quote Number 12249
 Project Number
 Date 06/01/2017
 Customer PO Number
 Customer Account CITLIN
 Account Manager Ryan Stanbrough
 Page 6 of 14

	Each	Y7790. +Palm Rest,Keybd Tray Mark Line For: Tag L1: Wrist Rest		
34	1.00	Herman Miller	35.70	35.70
	Each	Y7751. +Freestanding Palm Rest Mark Line For: Tag L1: Wrist Rest		
35	1.00	Herman Miller	48.45	48.45
	Each	Y7792. +Palm Rest,Input Device Platform Mark Line For: Tag L1: Wrist Rest		
36	1.00	Humanscale Corp	176.70	176.70
	Each	6G 900 90--H-G-22 6G Black Mechanism / 900 - Std. Platform / 90 - 8.5" Clip Mo H:High Clip Mouse G:19" Gel w/ Synt. Leather Cvr 22:Std 21.625" Track Mark Line For: Tag L1: Keyboard Tray Tag L3: Group 1		
37	1.00	Humanscale Corp	140.98	140.98
	Each	6FB 500--G27-14 6FB Float Keyboard System Mechanism Black / 500 - Big Platfo G27:27" Gel w/ Lycra 14:14" Track Mark Line For: Tag L1: Keyboard Tray Tag L3: Group 1		
38	1.00	Humanscale Corp	271.31	271.31
	Each	M8--C-B-1-W~--- M8 Monitor Arm C:Clamp Mount B:Black w/ Black Trim 1:Fixed Angled Link/Dynamic Link W:Long Crossbar for 2 Monitors ~:Standard 100mm x 100mm - also with 75x75 ~:Standard packaging for orders of 3 or more ---:No Selection Mark Line For: Tag L1: Monitor Arm-Dual Tag L3: Group 1		
39	1.00	Humanscale Corp	274.73	274.73
	Each	MF2--2-B-2-2-C-12~--- MFlex for M2 Arms 2:Bracket for 2 Monitors B:Black with Black Trim 2:8" Straight Link/Dynamic Link 2:8" Straight Link/Dynamic Link C:Clamp Mount		

AOI

Furniture Proposal

Quote Number 12249
 Project Number
 Date 06/01/2017
 Customer PO Number
 Customer Account CITLIN
 Account Manager Ryan Stanbrough
 Page 7 of 14

		12:12"H Post (Single Row Only) -:Std 100mm x 100mm(also used for 75mm x 75mm) ~:No Post Stop -:Standard packaging for orders of 3 or more ---:No Selection Mark Line For: Tag L1: Monitor Arm-Dual Tag L3: Group 1		
40	1.00 Each	Humanscale Corp M2--C-B-1-S----- M2 Monitor Arm C:Clamp Mount B:Black with Black Trim 1:Fixed Angled Link/Dynamic Link S:Standard Ball Joint -:Standard 100mm x 100mm - also with 75x75 -:Standard packaging for orders of 3 or more ---:No Selection Mark Line For: Tag L1: Monitor Arm-Single Tag L3: Group 1	125.02	125.02
41	1.00 Each	Humanscale Corp M8--C-B-1-S----- M8 Monitor Arm C:Clamp Mount B:Black w/ Black Trim 1:Fixed Angled Link/Dynamic Link S:Standard Ball Joint -:Standard 100mm x 100mm - also with 75x75 -:Standard packaging for orders of 3 or more ---:No Selection Mark Line For: Tag L1: Monitor Arm-Single Tag L3: Group 1	195.31	195.31
42	1.00 Each	Humanscale Corp FN--B-M-43-XXXXXXX Float Table B:Black M:Mounted 43:For 48-54" Wide x 30" Deep Tops XXXXXXXX:No Top Selection Mark Line For: Tag L1: Hgt Adj Base Tag L3: Group 2	949.50	949.50
43	1.00 Each	Humanscale Corp FN--B-M-63-XXXXXXX Float Table B:Black M:Mounted 63:For 60-72" Wide x 30" Deep Tops XXXXXXXX:No Top Selection	974.50	974.50

AOI

Furniture Proposal

Quote Number 12249
 Project Number
 Date 06/01/2017
 Customer PO Number
 Customer Account CITLIN
 Account Manager Ryan Stanbrough
 Page 8 of 14

		Mark Line For: Tag L1: Hgt Adj Base Tag L3: Group 2		
44	1.00 Each	Humanscale Corp FE--S-A-3-XXXXXXX Float Electric Table S:Silver A:Analog Controller 3:For 40-72" Wide x 30" Deep Tops XXXXXXX:No Top Selection Mark Line For: Tag L1: Hgt Adj Base Tag L3: Group 2	824.50	824.50
45	1.00 Each	Humanscale Corp FN--B-M-43-3048-BL-F Float Table B:Black M:Mounted 43:For 48-54" Wide x 30" Deep Tops 3048:30"D x 48"W Laminate Top BL:Black F:Flat Edge Mark Line For: Tag L1: Hgt Adj Table Tag L3: Group 2	1,162.00	1,162.00
46	1.00 Each	Humanscale Corp FN--B-M-43-3054-BL-F Float Table B:Black M:Mounted 43:For 48-54" Wide x 30" Deep Tops 3054:30"D x 54"W Laminate Top BL:Black F:Flat Edge Mark Line For: Tag L1: Hgt Adj Table Tag L3: Group 2	1,174.50	1,174.50
47	1.00 Each	Humanscale Corp FN--B-M-63-3060-BL-F Float Table B:Black M:Mounted 63:For 60-72" Wide x 30" Deep Tops 3060:30"D x 60"W Laminate Top BL:Black F:Flat Edge Mark Line For: Tag L1: Hgt Adj Table Tag L3: Group 2	1,212.00	1,212.00
48	1.00 Each	Humanscale Corp FN--B-M-63-3066-BL-F Float Table	1,222.00	1,222.00

AOI

Furniture Proposal

Quote Number 12249
 Project Number
 Date 06/01/2017
 Customer PO Number
 Customer Account CITLIN
 Account Manager Ryan Stanbrough
 Page 9 of 14

		B:Black M:Mounted 63:For 60-72" Wide x 30" Deep Tops 3066:30"D x 66"W Laminate Top BL:Black F:Flat Edge Mark Line For: Tag L1: Hgt Adj <u>Table</u> Tag L3: Group 2		
49	1.00 Each	Humanscale Corp FN--B-M-63-3072-BL-F Float Table B:Black M:Mounted 63:For 60-72" Wide x 30" Deep Tops 3072:30"D x 72"W Laminate Top BL:Black F:Flat Edge Mark Line For: Tag L1: Hgt Adj <u>Table</u> Tag L3: Group 2	1,242.00	1,242.00
50	1.00 Each	Humanscale Corp FE--S-A-2-E2448-BL-F Float Electric Table S:Silver A:Analog Controller 2:For 40-72" Wide x 24" Deep Tops E2448:24"D x 48"W Laminate Top BL:Black F:Flat Edge Mark Line For: Tag L1: Hgt Adj <u>Table</u> Tag L3: Group 2	1,022.00	1,022.00
51	1.00 Each	Humanscale Corp FE--S-A-2-E2454-BL-F Float Electric Table S:Silver A:Analog Controller 2:For 40-72" Wide x 24" Deep Tops E2454:24"D x 54"W Laminate Top BL:Black F:Flat Edge Mark Line For: Tag L1: Hgt Adj <u>Table</u> Tag L3: Group 2	1,037.00	1,037.00
52	1.00 Each	Humanscale Corp FE--S-A-2-E2460-BL-F Float Electric Table S:Silver A:Analog Controller 2:For 40-72" Wide x 24" Deep Tops	1,049.50	1,049.50

AOI

Furniture Proposal

Quote Number 12249
 Project Number
 Date 06/01/2017
 Customer PO Number
 Customer Account CITLIN
 Account Manager Ryan Stanbrough
 Page 10 of 14

		E2460:24"D x 60"W Laminate Top BL:Black F:Flat Edge Mark Line For: Tag L1: Hgt Adj Table Tag L3: Group 2		
53	1.00 Each	Humanscale Corp FE--S-A-2-E2466-BL-F Float Electric Table S:Silver A:Analog Controller 2:For 40-72" Wide x 24" Deep Tops E2466:24"D x 66"W Laminate Top BL:Black F:Flat Edge Mark Line For: Tag L1: Hgt Adj Table Tag L3: Group 2	1,064.50	1,064.50
54	1.00 Each	Humanscale Corp FE--S-A-2-E2472-BL-F Float Electric Table S:Silver A:Analog Controller 2:For 40-72" Wide x 24" Deep Tops E2472:24"D x 72"W Laminate Top BL:Black F:Flat Edge Mark Line For: Tag L1: Hgt Adj Table Tag L3: Group 2	1,079.50	1,079.50
55	1.00 Each	Humanscale Corp FE--S-A-3-E3048-BL-F Float Electric Table S:Silver A:Analog Controller 3:For 40-72" Wide x 30" Deep Tops E3048:30"D x 48"W Laminate Top BL:Black F:Flat Edge Mark Line For: Tag L1: Hgt Adj Table Tag L3: Group 2	1,037.00	1,037.00
56	1.00 Each	Humanscale Corp FE--S-A-3-E3054-BL-F Float Electric Table S:Silver A:Analog Controller 3:For 40-72" Wide x 30" Deep Tops E3054:30"D x 54"W Laminate Top BL:Black F:Flat Edge	1,049.50	1,049.50



Furniture Proposal

Quote Number 12249
 Project Number
 Date 06/01/2017
 Customer PO Number
 Customer Account CITLIN
 Account Manager Ryan Stanbrough
 Page 11 of 14

		Mark Line For: Tag L1: Hgt Adj Table Tag L3: Group 2		
57	1.00 Each	Humanscale Corp FE--S-A-3-E3060-BL-F Float Electric Table S:Silver A:Analog Controller 3:For 40-72" Wide x 30" Deep Tops E3060:30"D x 60"W Laminate Top BL:Black F:Flat Edge Mark Line For: Tag L1: Hgt Adj Table Tag L3: Group 2	1,062.00	1,062.00
58	1.00 Each	Humanscale Corp FE--S-A-3-E3066-BL-F Float Electric Table S:Silver A:Analog Controller 3:For 40-72" Wide x 30" Deep Tops E3066:30"D x 66"W Laminate Top BL:Black F:Flat Edge Mark Line For: Tag L1: Hgt Adj Table Tag L3: Group 2	1,072.00	1,072.00
59	1.00 Each	Humanscale Corp FE--S-A-3-E3072-BL-F Float Electric Table S:Silver A:Analog Controller 3:For 40-72" Wide x 30" Deep Tops E3072:30"D x 72"W Laminate Top BL:Black F:Flat Edge Mark Line For: Tag L1: Hgt Adj Table Tag L3: Group 2	1,092.00	1,092.00
60	1.00 Each	Humanscale Corp QS--B-H-30-F-N-N QUICKSTAND BASE B:Black H:Heavy Monitor Mount (Sgl Scrn) 30:30" Large Platform F:Freestanding Base N:No Cables N:No Cables Mark Line For: Tag L1: Sit/Stand Workstation Tag L3: Group 2	584.50	584.50
61	1.00	Humanscale Corp	609.50	609.50

AOI

Furniture Proposal

Quote Number 12249
 Project Number
 Date 06/01/2017
 Customer PO Number
 Customer Account CITLIN
 Account Manager Ryan Stanbrough
 Page 12 of 14

	Each	QS--B-C-30-F-N-N QUICKSTAND BASE B:Black C:Std Crossbar Monitor Mount (Dual Scrn) 30:30" Large Platform F:Freestanding Base N:No Cables N:No Cables Mark Line For: Tag L1: Sit/Stand Workstation Tag L3: Group 2		
62	1.00 Each	Humanscale Corp QS--B-W-30-F-N-N QUICKSTAND BASE B:Black W:Wide Crossbar Monitor Mount (Dual Scrn) 30:30" Large Platform F:Freestanding Base N:No Cables N:No Cables Mark Line For: Tag L1: Sit/Stand Workstation Tag L3: Group 2	619.50	619.50
63	1.00 Each	Humanscale Corp QSL--B-H-C QUICKSTAND LITE BASE B:Black H:Heavy Mount for 1 Monitor from 12-22 lbs C:Clamp Mount Mark Line For: Tag L1: Sit/Stand Workstation Tag L3: Group 2	449.50	449.50
64	1.00 Each	Humanscale Corp QSL--B-W-C QUICKSTAND LITE BASE B:Black W:Wide Crossbar Mount for 2 Monitors up to 27"W C:Clamp Mount Mark Line For: Tag L1: Sit/Stand Workstation Tag L3: Group 2	484.50	484.50

Order Sub-Total : \$42,914.82
Total Order : \$42,914.82

PLEASE REVIEW THIS QUOTATION AND NOTIFY US PROMPTLY OF ANY CORRECTIONS REQUIRED
 THANK YOU FOR THE OPPORTUNITY TO BE OF SERVICE
 PRICING EXPIRES 30 DAYS FROM QUOTE DATE

AOI

Furniture Proposal

Quote Number 12249
Project Number
Date 06/01/2017
Customer PO Number
Customer Account CITLIN
Account Manager Ryan Stanbrough
Page 13 of 14

All orders are subject to AOI Terms and Conditions.

Customer Signature

Date

Name

AOI

Furniture Proposal

Quote Number	12249
Project Number	
Date	06/01/2017
Customer PO Number	
Customer Account	CITLIN
Account Manager	Ryan Stanbrough
Page	14 of 14

Terms And Conditions

- Standard payment terms are Net 10 days from invoice. A 50% deposit is required on all orders.
- A 3% convenience fee will be added to invoice if a credit card is used. Credit cards will be charged in full at time of order.
- Products are made to order. AOI Corporation offers no return or restocking programs. Products may be returned only with prior written approval of AOI Corporation and the product manufacturer.
- Client changes submitted after final plan approval, and resulting in additional work, will be billed at our hourly rate, or through a mutually agreed upon addendum to the contract.
- All labor estimates have been based on AOI Corporation having clear access and use of receiving docks for product deliveries. The receiving area should be free and clear of other trades and products to prevent any delays.
- AOI Corporation will have scheduled elevator access for transporting product within the building.
- Each area in which furniture will be installed, will be substantially free and clear of other trades allowing us to stage and build product according to plan.
- Storage fees will be assessed when delays require AOI Corporation to warehouse product thirty 30 days past the scheduled installation date.
- Labor fees will be assessed when delivery address changes from the client site to an alternative receiving location.
- AOI Corporation will accept installation change requests from authorized client representatives only. Any agreed upon changes will be billed on an hourly basis, and invoiced monthly.
- Unless otherwise stated, all quoted installation work to be performed during normal business, Monday through Friday.
- Construction flaws effecting furniture installation will be reviewed as they are encountered.
- AOI Corporation is responsible for general cleaning of workstations following installation. This does not include excessive construction debris (i.e. drywall dust) resulting from construction work still in progress in the build areas.
- AOI Corporation is not responsible for product damage resulting from deliveries received directly by client representatives. AOI does not file freight claims on products drop shipped to a customer location.
- AOI may charge, and the Customer shall pay, taxes which AOI is required to collect and remit by law in connection with any sale. Customer shall pay unless AOI has received, in advance of the initial delivery, sufficient written documentation from Customer establishing exemption from such tax(es).
- Pricing expires 30 days from proposal date.
- All designs, plans, drawings, specifications, samples, and the contents there in regarding this sale shall remain the property of AOI, and may not be used, reproduced or distributed without express written permission of AOI

Herman Miller – US Communities/Installed Contract Pricing Tiers

- Height Adjustable Tables
 - Tier 1: \$1.00 - \$100,000 LIST: 62% Discount
 - Tier 2: \$100,001 - \$400,000 LIST: 64% Discount
 - Tier 3: \$400,001 – and up LIST: Negotiable
- Keyboard Trays, Monitor Arms, Sit/Stand Workstations, Wall-Mounted Technology, Wrist Rests
 - Tier 1: \$1.00 - \$100,000 LIST: 49% Discount
 - Tier 2: \$100,001 - \$400,000 LIST: 51% Discount
 - Tier 3: \$400,001 – and up LIST: Negotiable

Humanscale – Installed Pricing Tiers

- Ergonomic Tools, Keyboards, Monitor Arms, Laptop/CPU Holders, Lighting
 - Tier 1: \$1.00 - \$50,000 LIST: 62% Discount
 - Tier 2: \$50,001 - \$150,000 LIST: 64% Discount
 - Tier 3: \$150,001 – and up LIST: Negotiable
- Float, QuickStand, QuickStand Lite
 - Tier 1: \$1.00 - \$100,000 LIST: 50% Discount
 - Tier 2: \$100,001 - \$200,000 LIST: 53% Discount
 - Tier 3: \$200,001 – and up LIST: Negotiable



A warranty is a promise.

Here's ours: 12 years, 3 shifts, labor included

Our warranty covers everything—including electrical components, casters, pneumatic cylinders, tilts, and all moving mechanisms.

It recognizes the changing nature of work and the need for products that can stand up to continuous use.

And it means that when warranty work is performed in the U.S. and Canada, Herman Miller foots the bill.

At Herman Miller, we work for a better world around you. Our products—and our promise to stand behind their quality 100 percent—are designed to improve your environment whether it's an office, hospital, school, home, an entire building, or the world at large.



All products sold under the Herman Miller brand, including Herman Miller Healthcare products, Geiger products, Eames aluminum group, Eames Soft Pad group, Eames executive chairs, and Eames tables, are backed by our 12-year, 3-shift warranty, except as limited or described below. Warranty information for Nemschoff products can be found by visiting nemschoff.com/customer-service/warranty. Warranty information for Maharam textiles can be found by visiting maharam.com/site/terms.

Herman Miller Products

5 years

Herman Miller Collection products; Connect power and data; Cubert , Flute , and Tone personal task lights; Exclave whiteboards, tackboards, and accessories; Flo power hub; Formwork and Ubi liners; Logic Power Access Solutions; Mbrace wall-mounted technology; Ode lamps; Procedure/Supply Carts keyless lock bars; Twist LED task light; Ubi USB power module

3 years

Herman Miller Collection outdoor products; Compass system faucet

2 years

Magis and Mattiazzi branded products from the date of purchase by the original purchaser

1 year

Formwork stackable desktop storage; Nelson Bubble Lamps

None

Beware of Imitations poster; Exclave eco boards; Girard throw; Maharam Memory 3 game; Maharam pillows; Textiles & Objects poster

Herman Miller Materials

5 years

Herman Miller proprietary fabrics applied to seating products (exceptions covered under 12-year warranty include: AireWeave 2, Balance, Bingo, Colorguard, Crepe, FLEXNET , Leather, Lyris 2 , MCL Leather, Mercer, Pellicle , Rhythm, and Strata); Sayl knit back cover

1 year

Herman Miller Design on Textile (DOT) and Customer's Own Image (COI)

Parts and Components

5 years

Electronic ballasts used in task lighting; keyless lock on Compass; mechanical components (drive shaft, motor, etc.) on Locale height-adjustable surface; mechanical and electrical components on Motia sit-to-stand tables; Renew sit-to-stand pneumatic counterbalance and crank mechanism; power leg access option on Renew sit-to-stand tables

3 years

All service parts; electric motors for Co/Struc height-adjustable tables

2 years

Electrical components (switch, control box, etc.) on Locale height-adjustable surface

1 year

Compass system faucet sensors and control box

6 months

All other products, parts, and any services not listed above, sold or furnished by Herman Miller or its subsidiaries, except for consumable products such as dry-erase markers, erasers, light bulbs, fans, and other electronic products for which no warranty is given

Other Manufacturers' Products

Herman Miller does not warrant other manufacturers' product but will pass through to the original purchaser any warranty supplied by other manufacturers to the extent possible, including, but not limited to, open line laminates.



Provisions that apply to all Herman Miller-branded products and services:

Herman Miller, Inc. ("Herman Miller"), 855 East Main Avenue, PO Box 302, Zeeland, Michigan 49464-0302, USA, warrants the products sold by it and its subsidiaries to be free from defects in material and workmanship, regardless of the number of shifts during which the products are used, for the warranty periods specified below

This limited warranty covers the sale of Herman Miller product in all countries. Not all of the product lines appearing on this list are marketed by Herman Miller in all countries, and appearance on this list does not imply an offer for sale of a product line in a particular place. Product line availability is defined in current price lists applicable to different regions.

During the applicable warranty period, Herman Miller, as its sole obligation, will repair or replace (at its option) any product, part, or component covered by this warranty and sold after the effective date of this warranty, which fails under normal use as a result of a defect in material or workmanship. Herman Miller will repair or replace the aforementioned product, part, or component with a comparable product, part, or component.

This warranty extends only to the original purchasers who acquire new product from Herman Miller, its subsidiaries, or its authorized resellers. Any product, part, or component must have been used according to Herman Miller's published instructions and installed and maintained by a Herman Miller factory-trained technician or an authorized Herman Miller dealer installer. If these requirements are met, warranty coverage will be extended. Any misuse, abuse, or modification to the original product voids the warranty. Herman Miller does not warrant the performance of the product when used in combination with other than original Herman Miller product.

Limited warranty only covers Herman Miller provided products, components, and related repair work performed by Herman Miller authorized dealers.

The warranty period starts from the date of purchase.

This document inclusively describes all of the warranties given and remedies available with respect to the company's products and services. Herman Miller and its subsidiaries disclaim any other warranty whether express or implied, statutory or otherwise, in relation to the products.

Herman Miller does not warrant:

- natural variations in wood grain or figure or the presence of character marks
- changes in surface finishes, including colorfastness, due to aging, exposure to light or direct sunlight
- marks, scars, or wrinkles occurring naturally in leather
- veins, marks, voids, fissures, or cracks found naturally in stone
- failure resulting from normal wear and tear
- piling of textiles
- matching of colors, grains, or textures of natural materials
- colorfastness or the matching of colors of textiles or surface finishes, including an exact match to cuttings, samples, or swatch cards

- damage, marking, or staining of veneer surfaces due to contact with rubber or similar compounds; damage from sharp objects or imprinting from writing instruments
- changes in the decibel level of motors or mechanisms utilized in height-adjustable products
- damage or marking of materials or abrading of textiles over time caused by sharp or foreign objects
- discoloration of textiles and surface materials due to soiling, stains, or dye transfer from clothing, including denim

Herman Miller tests Customer's Own Material (COM) and other customer-supplied items for manufacturing quality only and does not provide any warranty with regard to these materials.

Herman Miller does not warrant products that are exposed to extreme environmental conditions or that have been subject to improper storage.

TO THE EXTENT ALLOWED BY LAW, ANY IMPLIED WARRANTIES, INCLUDING ANY WARRANTY OF MERCHANTABILITY OR FITNESS FOR A PARTICULAR PURPOSE, ARE DISCLAIMED AND TO THE EXTENT THEY ARE LEGALLY REQUIRED, ARE LIMITED IN DURATION TO THE DURATION OF THIS WRITTEN WARRANTY.

HERMAN MILLER SHALL NOT BE LIABLE FOR LOSS OF TIME, INCONVENIENCE, COMMERCIAL LOSS, OR INCIDENTAL OR CONSEQUENTIAL DAMAGES.

Applies in US only: Some states do not allow limitations on how long an implied warranty lasts or do not allow the exclusion or limitation of incidental or consequential damages, so the limitations or exclusions in the two preceding paragraphs may not apply. This warranty gives the purchaser specific legal rights; however, the purchaser may also have other rights that may vary from state to state.

Applies outside US: Except as stated above, Herman Miller will not be liable for any loss or damage (including costs) however caused, whether direct or consequential, incurred or suffered by the purchaser or any third party in respect of the products, but nothing contained herein will or will be considered to exclude or restrict any liability on Herman Miller's part for death or personal injury resulting from negligence.

Effective May 2017

HermanMiller

For more information about our products and services or to see a list of dealers, please visit us at hermanmiller.com or call (888) 443 4357.

© 2017 Herman Miller, Inc., Zeeland, Michigan

® Herman Miller, Bubble Lamps, Co/Struc, Eames, Flo, Formwork, Geiger, Locaie, Maharam, and Pellele are among the registered trademarks of Herman Miller, Inc., and its owned subsidiaries.

™ AireWeave, Compass, Connect, Cubert, DCI, Eames Soft Pad, Exclave, FLEXNET, Flute, Lyris 2, Motia, Nelson, Ode, Renew, Sayt, Tone, Twist, and Ubi are among the trademarks of Herman Miller, Inc., and its owned subsidiaries.

Search | [Home](#) | [About Us](#) | [Products](#) | [Ergonomics](#) | [Resources](#) | [About](#) | [Contact Us](#) | [Legal Info](#)

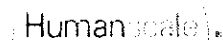

[PRODUCTS](#)

[ERGONOMICS](#)

[RESOURCES](#)

[ABOUT](#)

[HEALTHCARE](#)

[About Us](#) | [Legal Information](#)

Humanscale's Terms & Conditions

THE FOLLOWING TERMS & CONDITIONS APPLY TO ALL HUMANSCALE PRODUCTS OTHER THAN HUMANSCALE HEALTHCARE PRODUCTS

THE TERMS & CONDITIONS FOR HUMANSCALE HEALTHCARE PRODUCTS ARE PROVIDED [HERE](#).

TERMS OF PAYMENT

Upon approved credit, terms of payment are net 30 from date of shipment. Deposits may be required for large or custom orders. The processing of orders and/or shipment of orders placed may be delayed if the deposit is not received with the order or if customer's account is in "Past Due" status.

CREDIT POLICY

All customers of Humanscale must complete a credit application, with current information, which must be signed by an owner or officer. A line of credit may be set by our Credit Department, however the basis for the line of credit may be changed or cancelled at our discretion and advance payment may be required. Any unpaid balance, upon which payments are not made according to the terms governing the sale, will be considered "Past Due" and will increase by a maximum of 2% per month, without forfeit of Humanscale's right to payment.

Any customer who has failed to pay for goods delivered or services rendered in a timely manner shall be liable for all fees, expenses, disbursements, and charges (including all legal costs) incurred by Humanscale in collecting monies owed, as well as interest (at 24% per annum).

PURCHASE ORDERS

Purchase orders must include the following "Bill To" and "Ship To" information--Company Name (Ship To company may be end user or installation company), Address, Telephone, Fax, Contact Person, End User Company Name, Requested Ship Date, Purchase Order Number, Special Delivery, Shipping and Packing Instructions (if applicable), Proper Discount Off Current List Price, Product Quantities and Full Model Numbers, and Total (incl. Net):

ORDER CHANGES AND CANCELLATIONS

All changes to or cancellations of orders placed with Humanscale must be in writing and sent to Humanscale Customer Service. All changes to or cancellations of Quick Ship orders will incur a minimum change/cancellation fee of 10% of net. All other orders may be changed or cancelled without penalty if Humanscale is notified at least two (2) weeks before the scheduled ship date for standard orders (under 250 units), or at least three (3) weeks before the scheduled ship date for large orders (250 units or more). Order changes or cancellations made less than two (2) weeks before the scheduled ship date for standard orders or less than three (3) weeks before the scheduled ship date for large orders will incur a minimum change/cancellation fee of 10% of net, irrespective of when notified, changes or cancellations are not binding upon Humanscale until Humanscale issues a written acknowledgment of the change or cancellation. Order changes are defined as the deletion of line items, changes in style, color, quantity or requested ship date, or ship to address changes. Order changes that result in a quantity reduction may be subject to an additional small order fee or adjustment in pricing. Under no circumstances will changes or cancellations be accepted on any custom fabric, special order or custom product orders.

TAXES

Humanscale list prices do not include sales tax. Customer is responsible to remit all such tax. Humanscale requires a State Resale/Exemption Certificate to be on file at its main office. Sales made without said Certificate will be charged the appropriate sales tax.

PRICES

All discounts and list prices are subject to change without notice. Prices are those in effect at the time of order entry. If the requested shipment date is more than 90 days after the order date, Humanscale reserves the right to price said order based on the published list price as of the shipment date.

SMALL ORDER FEE

A 3% small order fee applies to all invoiceable orders of \$1,500 net or less, including billable replacement parts, regardless of product category. This small order fee does not apply to orders made through quickstand.humanscale.com or www.humanscale.com.

SHIPPING AND DELIVERY

All Humanscale orders are acknowledged with a promise date (scheduled ship date) based on the product with the longest lead time. Large orders may increase standard lead times. Standard shipping charges will be billed to customer. Custom platform orders require 4 to 6 weeks.

Quick Ship seating orders for up to 50 chairs will ship within 10 business days from the date of order entry as long as Quick Ship was specified on the order. Seating orders for up to 150 chairs will ship within four weeks from the date of order entry for chairs containing any combination of Wave, Yellin, Mandelbaum Shape, Posture and Dash fabrics. Seating orders for up to 100 chairs will ship within six weeks from the date of order entry for

all other labels. Consult with your Humanscale representative for lead times on all other seating orders. Unless otherwise contractually specified, Efficient World, Freedom and Liberty chairs will ship with the base and frame disassembled. Chairs can be easily assembled in seconds without use of tools. Blanket-wrapped shipping is available for full truckloads of 200 or more Efficient World, Freedom or Liberty Task and Conference chairs. Consult your Humanscale representative for blanket-wrapped shipping requirements for Canto and the Liberty Side chair.

Ship Sets:

All products ordered on a single purchase order will be delivered together in a single ship set. To treat a ship set, customers must indicate "Ship as Available" on the purchase order. Upon request, customer accounts may be authorized to ship all orders on an as available basis.

Shipping Instructions:

Humanscale will attempt to accommodate basic shipping instructions, such as "call ahead" or "deliver before 12:00 pm," if clearly identified on the purchase order as "Shipping Instructions."

Packing Instructions:

Humanscale will attempt to accommodate basic packing instructions for internal delivery of specific items on an order, such as "Deliver to Joe Smith" or "Deliver to suite #218," if clearly identified on the purchase order as "Packing Instructions."

DELIVERY SHORTAGES

Product shortages must be noted at the time of delivery and reported to the carrier for correction. Claims against Humanscale for shortages, errors, etc., must be made in writing and within three (3) days of the date of delivery or customer waives its right to make such a claim.

FREIGHT CLAIMS

Humanscale will file all F.O.B. destination claims. In order to receive credit, customer agrees to cooperate and assist in the procedures set out by the carrier and Humanscale.

EXTERNAL DAMAGE

If the shipping container shows any external damage, customer is instructed to refuse the product at time of delivery. If it is a multiple piece shipment, customer may refuse only the damaged items. Humanscale will not issue full credit for returned product unless customer takes the following action steps:

1. Note damage on the delivery receipt at time of delivery.
2. Refuse product at time of delivery.
3. Contact Humanscale Customer Service within 24 hours of the attempted delivery and advise them of the damage.
4. Enter a chargeable replacement order; credit will be issued after the disposition of damaged product is determined.

CONCEALED DAMAGE/LOSS

If customer determines that there is internal damage not visible at time of delivery, customer will retain all packaging materials and take the following action steps within fifteen (15) calendar days from the date of delivery:

1. Request inspection by calling local freight carrier to report damage.
2. Retain merchandise in the original box.
3. Call your Humanscale Customer Service agent to provide order and product information.
4. Get a copy of the inspection report from carrier.
5. Enter a chargeable replacement order; credit will be issued after the disposition of damaged product is determined.

STORAGE

If a customer is unable to accept a scheduled product delivery, Humanscale, if notified in writing after product assembly and prior to the scheduled ship date, will store the product at customer's expense. Humanscale shall invoice customer for the product and monthly Storage Fees.

Storage Fees will be 1% of the net order value per month or actual storage costs—whichever is greater. Storage Fees are calculated with a one-month minimum and will not be pro-rated. If customer is unable to accept a scheduled product upon delivery, customer shall be responsible for placing the product in storage and bears the risk of loss. However, payment of the balance due is per Humanscale's Terms of Payment.

RETURN AUTHORIZATIONS and REFUSALS

All returned and non-damaged refused orders are subject to a five percent (5%) restocking fee. Seating and special order returns will not be accepted. Customer must request a Return Authorization through the Humanscale Customer Service Department within 45 days of product receipt to return any product. If Humanscale agrees to restock the product, customer must return it freight prepaid to Humanscale, F.O.B., to the original shipping point or as otherwise instructed by Humanscale Customer Service. If product is returned without a Return Authorization, Humanscale will notify customer of the unauthorized return and customer must provide instructions for its disposition within one week thereafter. Failure of customer to respond within one week will result in Humanscale's right to dispose of the product with no credit. Return Authorizations expire sixty (60) days after the date of issue. If the returned product is not in resalable condition, customer will not receive credit for the return. Customer must promptly provide a purchase order or other acceptance of fees/credit reduction as required.

RETURN AUTHORIZATIONS and REFUSALS - TECHNOLOGY PRODUCTS

all returned and non-damaged refused orders are subject to a thirty percent (30%) restocking fee. Special order returns will not be accepted. Customer must request a Return Authorization through the Humanscale Customer Service Department within 15 days of product receipt to return any product. If Humanscale agrees to restock the product, customer must return it freight prepaid to Humanscale, F.O.B., to the original shipping point or as otherwise instructed by Humanscale Customer Service. If product is returned without a Return Authorization, Humanscale will notify customer of the unauthorized return and customer must provide instructions for its disposition within one week thereafter. Failure of customer to respond within one week will result in Humanscale's right to dispose of the product with no refund. Return Authorizations expire sixty (60) days after the date of issue. If the returned product is not in resalable condition, customer will not receive credit for the return. Customer must promptly provide a purchase order or other acceptance of loss/credit reduction as required.

LIMITED WARRANTY

Humanscale offers the following warranties on its products, subject to any exclusions and limitations as set forth below:

Product	Warranty
Customer's Own Material (COM, COE)	No Warranty
Swivel Mouse	1 Year, 24/7 Warranty
Technology Products	3 Years, Limited Warranty
Flex and Series Lights	10 Years, 24/7 Warranty
Horizon Series Lights	10 Years, 24/7 Warranty
Diffrient Series Lights	5 Years, 24/7 Warranty
Float Table, (Mechanical)*	5 Years, 24/7 Warranty
eFloat and Electric Float***	5 Years, 24/7 Warranty
QuickStand Sit/Stand Workstation	5 Years, 24/7 Warranty
Quick Stand Lite	5 Years, 24/7 Warranty
Fabric/Cushions/Arm Pads	5 Years, Single-Shift Warranty
M2, MAFlex & ParaFlex Monitor Arms	15 Years, 24/7 Warranty
M4, M7 & M8 Monitor Arms w/tilt Gas Cylinder Components	10 Years, 24/7 Warranty
Ballo Stool**	3 Years, Single-Shift Warranty
Vessel Lights†	10 Years, 24/7 Warranty, 3 Years 24/7 Warranty for the power supply driver
All other seating and products detailed in a current Humanscale Price Guide, unless otherwise specified	15 Years, 24/7 Warranty
All other products NOT detailed in a current Humanscale Price Guide	Varies, consult your Humanscale representative for details

*Modifying or tampering with any part of the base of the Float Table will render the warranty void. The warranty on the Float Table applies to the base and work surface if the table top is provided by Humanscale, and only to base if the table top is provided by a third party, provided that the third party table top meets the following requirements: (i) has a depth of 36" or less, (ii) has a width of 72" or less, and (iii) the total weight load including work surface is no more than 130 lbs for the standard base and no more than 160 lbs for the heavy duty base.

** Note: Ballo is not a task chair. It has not passed the BIFMA or European EN standards for office seating. The Ballo is an exercise chair that is designed for dynamic seating and frequent movement. All Ballo instructions should be followed to ensure a comfortable experience.

*** Modifying or tampering with any part of the base of the eFloat or electric Float will render the warranty void. The warranty on the eFloat and Electric Float applies to the base and work surface if the table top is provided by Humanscale, and only to base if the table top is provided by a third party, provided that the third party table top meets the following requirements: (i) has a depth of 36" or less, (ii) has a width of 72" or less, and (iii) a total weight load including work surface of no more than 200 lbs.

†The warranties for the Vessel lights exclude labor and other costs associated with the installation and/or removal of the lights from ceilings, walls, fixtures, etc. Further, Humanscale has no warranty obligations if the product is affected by internal or external environmental conditions (including but not limited to water, moisture, outdoor use, or temperature damage), power fluctuations, improper power supply, or if the product is not installed and used in compliance with all applicable standards and electrical codes.

These warranties are available to the original end user (customer) only and are non-transferable. For these warranties to be valid, the Humanscale product must have been purchased directly from Humanscale and/or an authorized dealership, distributor, retailer and/or reseller of Humanscale products. If products are purchased through an authorized dealership, distributor, retailer and/or reseller, the end user (customer) must be registered with Humanscale for the warranty to be in effect. Humanscale warrants that, at the time of customer's receipt, the product will be in good working order and will be free from defects in materials and workmanship for the duration of the warranty term, as set forth above. These warranties do not apply to normal wear and tear or damage caused by accident, neglect, product abuse, misuse or other failure to follow instructions relating to the product's installation or intended use. Humanscale will not be responsible for damage due to service, maintenance, modifications or tampering by anyone other than a Humanscale authorized representative. Humanscale will not be responsible for injury or damage caused by or associated with the installation and/or use of products in any manner other than in strict conformance with the instructions set forth in its installation manuals and instruction sheets and/or product literature. These warranties do not cover damage caused by a carrier or transportation of the product from one location to another, or alterations made by owner. Humanscale does not warrant damages or defects to the products under the following conditions: an Act of God, damage from electrical power problems, usage of parts or components not supplied by Humanscale, failure to perform preventive maintenance, or damage caused by peripherals not supplied by Humanscale.

In the event a product or product part is defective in material or workmanship during the warranty period, and Humanscale receives written notice of the defect within the warranty period, Humanscale will determine with customer if the defect is covered under warranty. Humanscale, at its option, may repair or replace the defective product or product part determined to be under warranty with the same or comparable product or product part as determined by Humanscale, at customer's location or at a designated Humanscale location. The labor costs associated with the repair of the product or product part may be the responsibility of Humanscale if the product or product part is determined to be under warranty. Humanscale must pre-approve the labor costs prior to the repair or replacement of warranty products or product parts. Customer must contact Humanscale to obtain a Return Authorization through the Humanscale Customer Service Department. Performance of any repair or replacement does not renew or extend the warranty period. If, after examining and testing a returned product or product part, Humanscale determines that the product or product part is not defective, Humanscale will notify customer and return the product or product part to customer. Customer will be responsible for the freight charges associated with the return of non-defective products or product parts. To return a product or product part for repair that is not covered by warranty, customer must request a Return Authorization through the Humanscale Customer Service Department. Customer will bear the costs of labor and freight charges associated with non-warranty repair. Customer will be charged a standard repair fee, specific to the product, for any product that is repaired outside of the warranty period. Repairs on products out of warranty also carry a 90-day warranty, effective the day that Customer receives the repaired product or product part. For products that are not covered under warranty, Customer may upgrade to a newer, functionally equivalent product at the list price; the product or product part will be returned to Customer, or Customer can request in writing that Humanscale dispose of the product or product part for Customer, in which case a fee may apply as designated by local law.

DISCLAIMER

THIS LIMITED WARRANTY IS IN LIEU OF ALL OTHER REPRESENTATIONS, WARRANTIES OR CONDITIONS, EXPRESS OR IMPLIED, INCLUDING, BUT NOT LIMITED TO, ANY IMPLIED REPRESENTATIONS, WARRANTIES OR CONDITIONS OF MERCHANTABILITY, FITNESS FOR A PARTICULAR PURPOSE, NON-INFRINGEMENT, NON-INTERFERENCE, AND ALL OTHER WARRANTIES ARISING FROM COURSE OF DEALING OR USAGE OF TRADE.

Humanscale does not warrant that customer's use of the Humanscale product will be uninterrupted or error free. Any implied warranties that may be imposed by law are limited in duration to the Limited Warranty period, to the greatest extent allowed by law. Some states or countries do not allow a limitation on how long an implied warranty lasts or the exclusion or limitation of incidental or consequential damages for consumer products. In such states or countries, some exclusions or limitations of this Limited Warranty may not apply. This Limited Warranty is subject to change without notification.

LIMITATION OF LIABILITY

Purchaser's remedies set forth herein are exclusive and the liability of Humanscale with respect to the breach of this agreement or any contract entered into between the parties pursuant hereto shall not exceed the price of the product or part on which such liability is based. In no event will Humanscale be liable to purchaser for any special, collateral, incidental or consequential damages however caused, whether by Humanscale's negligence or otherwise. The remedies provided above are the purchaser's sole remedies for any failure of Humanscale to comply with its obligations regarding the workmanship of its products. Correction of any nonconformity in the manner and for the period of time provided shall constitute complete fulfillment of all liabilities of Humanscale with respect to or arising out of the product furnished hereunder.



ESSENTIAL WORKSTATIONS

- [Home](#)
- [Office](#)
- [Ergonomic Chairs](#)
- [Ergonomic Desks](#)
- [Ergonomic Mice](#)
- [Ergonomic Keyboards](#)

ERGONOMIC ACCESSORIES

- [Ergonomic Mice](#)
- [Ergonomic Keyboards](#)
- [Ergonomic Mouse Pads](#)
- [Ergonomic Chair Pads](#)
- [Ergonomic Stools](#)
- [Ergonomic Footrests](#)

ERGONOMIC CONSULTING SERVICES

- [Virtual Ergonomics](#)
- [Ergonomic Assessments](#)

DESIGN TOOLKIT

- [Download Library](#)
- [Watch Us Here & Learn](#)

COMPANY OVERVIEW

- [Corporate Social Responsibility](#)
- [Design Studio](#)
- [Where to Buy](#)
- [Global Partners](#)
- [Careers](#)
- [Legal Information](#)

HEALTH CARE PRODUCTS

- [Healthcare Resources](#)
- [Reseller Portal](#)
- [AMG® International](#)
- [Healthcare](#)
- [Promoting Health & Well-Being](#)