

CONTRACT DOCUMENTS

LANCASTER COUNTY

NEBRASKA

For

Bid No. 17-049

Project No: 17-05

PAVEMENT STRIPING

Straight-Line Striping, Inc.

423 Ponderosa Drive

Grand Island, NE 68803

LANCASTER COUNTY, NEBRASKA
CONTRACT AGREEMENT

THIS CONTRACT, made and entered into this ____ day of _____, _____, by and between Straight-Line Striping, Inc., hereinafter called the Contractor, and the County of Lancaster, Nebraska, a political subdivision of the State of Nebraska, hereinafter called the County.

WHEREAS, the County has caused to be prepared in accordance with law, Specifications, Plans, and other Contract Documents for the Work herein described and has caused to be published an advertisement for and in connection with said Work, to-wit: Bid No. 17-049, Project No. 17-05, Pavement Striping; and

WHEREAS, the Contractor, in response to such advertisement, has submitted to the County, in the manner and at the time specified, a sealed Proposal in accordance with the terms of said advertisement; and

WHEREAS, the County, in the manner prescribed by law has publicly opened, read aloud, examined, and canvassed the Proposals submitted in response to such advertisement, and as a result of such canvass has determined and declared the Contractor to be the lowest responsible bidder for the said Work for the sum or sums named in the Contractor's Proposal, a copy thereof being attached to and made a part of this Contract.

NOW, THEREFORE, in consideration of the sums to be paid to the Contractor and the mutual covenants herein contained, the Contractor and the County hereby agree as follows:

1. The Contractor agrees to (a) furnish all tools, equipment, supplies, superintendence, transportation, and other construction accessories, services, and facilities; (b) furnish all materials, supplies, and equipment specified to be incorporated into and form a permanent part of the complete work; (c) provide and perform all necessary labor in a substantial and workmanlike manner and in accordance with the provisions of the Contract Documents; and (d) execute construct, and compete all work included in and covered by the County's award of this Contract to the Contractor, such award being based on the acceptance by the County of the Contractor's Proposal.
2. The County agrees to pay the Contractor for the performance of the work embraced in this Contract and the Contractor agrees to accept as full compensation therefor, the following sums for all work covered by and included in the Contract award and designated above, payment thereof to be made in the manner provided by the County in the sum of Two Hundred Fourteen Thousand Nine Hundred Ninety Dollars and 00/100 (\$214,990.00).
3. EQUAL EMPLOYMENT OPPORTUNITY: In connection with the carrying out of this project, the Contractor shall not discriminate against any employee, applicant for employment, or any other person because of race, color, religion, sex, national origin, ancestry, disability, age or marital status. The Contractor will take affirmative action to ensure that applicants are employed, and that employees are treated during employment, without regard to their race, color, religion, sex, national origin, ancestry, disability, age or marital status. Such action shall include, but not be limited to, the following: employment, upgrading, demotion or transfer; recruitment or recruitment advertising; layoff or termination; rates of pay or other compensation; and selection for training, including apprenticeship.
4. To the extent permitted by law, the County relinquishes control of the construction site to the Contractor and its subcontractors during the period of construction. The construction, placement of barricades, and posting of warning signs in the area of construction will be the responsibility of the Contractor. This shall include the placement of construction equipment and any obstacles which are created as a result of the construction project. The placement of barricades and warning signs shall be in compliance with the Manual on Uniform Control Devices, the 2011 City of Lincoln Standard Specifications for Municipal Construction, as supplemented by the 2007 Edition of the Standard Specifications of Highway Construction of the State of Nebraska, the Special Provisions, Supplementary Special Provisions, and all other supplementary documents to this Agreement. To the extent permitted by law, the Contractor expressly accepts control of the construction site, such control shall include, but not be limited to, barricades, signs, road crossings, warning signs, construction equipment and any obstacles created during construction of the project.
5. It is the express intent of the parties that this Agreement shall not create an employer-employee relationship. Employees of the Contractor shall not be deemed to be employees of the County and employees of the County shall not be deemed to be employees of the Contractor. The Contractor and the County shall be responsible to their respective employees for all salary and benefits. Neither the Contractor's employees nor the County's employees shall be entitled to any salary, wages, or benefits from the other party, including but not limited to overtime, vacation, retirement benefits, workers' compensation, sick leave or injury leave. Contractor shall also be responsible for maintaining workers' compensation insurance, unemployment insurance for its employees, and for payment of all federal, state, local and any other payroll taxes with respect to its employees' compensation.

6. Each party agrees to indemnify and hold harmless, to the fullest extent allowed by law, the other party and its principals, officers, and employees from and against all claims, demands, suits, actions, payments, liabilities, judgments and expenses (including court-ordered attorneys' fees), arising out of or resulting from the acts or omissions of their principals, officers, or employees in the performance of this Agreement. Liability includes any claims, damages, losses, and expenses arising out of or resulting from performance of this Agreement that results in any claim for damage whatsoever including any bodily injury, civil rights liability, sickness, disease, or damage to or destruction of tangible property, including the loss of use resulting therefrom. Further, each party shall maintain a policy or policies of insurance (or a self-insurance program), sufficient in coverage and amount to pay any judgments or related expenses from or in conjunction with any such claims. Nothing in this Agreement shall require either party to indemnify or hold harmless the other party from liability for the negligent or wrongful acts or omissions of said other party or its principals, officers, or employees.
7. This Contract shall be effective upon execution by both parties. The Work included in this Contract shall commence on June 5, 2017 (*or upon notice to proceed by the County*) and shall be completed on or before August 11, 2017 (*or within 68 calendar days*).
8. If any portion of this Agreement is held invalid, the remainder hereof shall not be affected thereby if such remainder would then continue to conform to the terms and requirements of applicable law.
9. **GUARANTEE:** A Performance and Labor and Material Payment Bond in the full amount of the Contract shall be required for all construction contracts.
10. In accordance with Neb. Rev. Stat. 4-108 through 4-114, the Contractor agrees to register with and use a federal immigration verification system, to determine the work eligibility status of new employees performing services within the state of Nebraska. A federal immigration verification system means the electronic verification of the work authorization program of the Illegal Immigration Reform and Immigrant Responsibility Act of 1996, 8 U.S.C. 1324 a, otherwise known as the E-Verify Program, or an equivalent federal program designated by the United States Department of Homeland Security or other federal agency authorized to verify the work eligibility status of a newly hired employee pursuant to the Immigration Reform and Control Act of 1986. The Contractor shall not discriminate against any employee or applicant for employment to be employed in the performance of this section pursuant to the requirements of state law and 8 U.S.C.A. 1324b. The Contractor shall require any subcontractor to comply with the provisions of this section.
11. This Contract Agreement, along with the Suppliers Response, Plans and the following Supplemental Contract Documents, attached hereto and incorporated by this reference, form this Contract:
 1. Instructions to Bidders
 2. Supplemental Instructions to Bidders
 3. Map
 4. Accepted Proposal of Contractor
 5. Contractor Work Resume Form
 6. Special Provisions
 7. Performance and Labor and Material Payment Bond
 8. Purchasing Agent Appointment
 9. Nebraska Resale or Exempt Sale Certificate
 10. Tax Assessment Form
 11. Employer Classification Act Instructions
 12. Employee Classification Act Affidavit
 13. Insurance Clause and Certificate

The Contractor and the County hereby agree that all the terms and conditions of this Contract shall be binding upon themselves, and their heirs, administrators, executors, legal and personal representatives, successors, and assigns.

IN WITNESS WHEREOF, the Contractor and the County do hereby execute this contract.

EXECUTION BY LANCASTER COUNTY, NEBRASKA

ATTEST:

BY THE BOARD OF COUNTY COMMISSIONERS OF
LANCASTER COUNTY, NEBRASKA

County Clerk

Contract and Bond Approved as to Form
this _____ day of _____

Deputy County Attorney

EXECUTION BY CONTRACTOR

IF A CORPORATION:

Straight-Line Striping Inc.
Name of Corporation

ATTEST:

423 Ponderosa Dr.
(Address)

AC _____, secretary
Secretary

By: [Signature]
Duly Authorized Official

President
Legal Title of Official

IF OTHER TYPE OF ORGANIZATION:

Name of Organization

Type of Organization

Address)

By: _____
Member

By: _____
Member

IF AN INDIVIDUAL:

Name

Address

Signature

INSTRUCTIONS TO BIDDERS

LANCASTER COUNTY, NEBRASKA

PURCHASING DIVISION

E-Bid

1. BIDDING PROCEDURE

- 1.1 Sealed bid, (formal and informal), subject to Instructions and General Conditions and any special conditions set forth herein, will be received in the office of the Purchasing Division, 440 So. 8th St., Lincoln, NE 68508, until the bid closing date and time indicated for furnishing Lancaster County, hereinafter referred to as "County", the materials, supplies, equipment or services shown in the electronic bid request.
- 1.2 Bidders shall use the electronic bid system for submitting bids and must complete all required fields. If you do not care to bid, please respond to the bid request and note your reason.
- 1.3 Identify the item you will furnish by brand or manufacturer's name and catalog numbers. Also furnish specifications and descriptive literature if not bidding the specific manufacturer or model as listed in the specifications.
- 1.4 Any person submitting a bid for a firm, corporation, or other organization must show evidence of his authority so to bind such firm, corporation, or organization.
- 1.5 Bids received after the time and date established for receiving bids will be rejected.
- 1.6 The Bidders and public are invited, but not required, to attend the formal opening of bids. At the opening, prices will be displayed electronically and/or read aloud to the public. The pricing is also available for immediate viewing on-line. No decisions related to an award of a contract or purchase order will be made at the opening.

2. BID SECURITY

- 2.1 Bid security, as a guarantee of good faith, in the form of a certified check, cashier's check, or Bidder's bond, may be required to be submitted with this bid document, as indicated on the bid.
 - 2.1.1 Bid security, if required, shall be in the amount specified on the bid. The bid security must be scanned and attached to the "Response Attachments" section of your response or it can be faxed to the Purchasing office at 402-441-6513. The original bid security should then be sent or delivered to the office of the Purchasing Division, 440 S. 8th St., Ste. 200, Lincoln, NE 68508 within three (3) days of bid closing.
 - 2.1.2 If bid security is not received in the Purchasing Division as stated above, the vendor may be determined to be non-responsive.
- 2.2 If alternate bids are submitted, only one bid security will be required, provided the bid security is based on the amount of the highest gross bid.
- 2.3 Such bid security will be returned to the unsuccessful Bidders when the award of bid is made.
- 2.4 Bid security will be returned to the successful Bidder(s) as follows:
 - 2.4.1 For single order bids with specified quantities: upon the delivery of all equipment or merchandise, and upon final acceptance by the County.
 - 2.4.2 For all other contracts: upon approval by the County of the executed contract and bonds.
- 2.5 County shall have the right to retain the bid security of Bidders to whom an award is being considered until either:
 - 2.5.1 A contract has been executed and bonds have been furnished.
 - 2.5.2 The specified time has elapsed so that the bids may be withdrawn.
 - 2.5.3 All bids have been rejected.
- 2.6 Bid security will be forfeited to the County as full liquidated damages, but not as a penalty, for any of the following reasons, as pertains to this bidding document:
 - 2.6.1 If the Bidder fails or refuses to enter into a contract on forms provided by the County, and/or if the Bidder fails to provide sufficient bonds or insurance within the time period as established in this bidding document.

3. BIDDER'S REPRESENTATION

- 3.1 Each Bidder by electronic signature and submitting a bid, represents that the Bidder has read and understands the bidding documents, the bid attributes, the bid attachments, and the bid has been submitted in accordance therewith.
- 3.2 Each Bidder for services further represents that the Bidder has examined and is familiar with the local conditions under which the work is to be done and has correlated the observations with the requirements of the bid documents.

4. INDEPENDENT PRICE DETERMINATION

- 4.1 By submitting this bid, the Bidder certifies that the prices in this bid have been arrived at independently, without consultation, communication or agreement, for the purpose of restricting competition, as to any matter relating to such prices with any other Bidder or with any competitor; unless otherwise required by law, the prices which have been quoted in this bid have not been knowingly disclosed by the Bidder prior to bid opening directly or indirectly to any other Bidder or to any competitor; no attempt has been made, or will be made, by the Bidder to induce any person or firm to submit, or not to submit, a bid for the purpose of restricting competition.

5. CLARIFICATION OF SPECIFICATION DOCUMENTS

- 5.1 Bidders shall promptly notify the Purchasing Agent or designee of any ambiguity, inconsistency or error which they may discover upon examination of the bidding documents.
- 5.2 Bidders desiring clarification or interpretation of the bidding documents for formal bids shall make a written request which must reach the Purchasing Agent or designee at least five (5) calendar days prior to the date and time for receipt of formal bids.
- 5.3 Changes made to the bidding documents will be issued electronically. All vendors registered for that bid will be notified of the addendum. Subsequent Bidders will only receive the bid with the addendum included.
- 5.4 Oral interpretations or changes to the bidding documents made in any manner other than written form, will not be binding on the County; and Bidders shall not rely upon such interpretations or changes.

6. ADDENDA

- 6.1 Addenda are instruments issued by the County prior to the date for receipt of bids which modify or interpret the bidding document by addition, deletion, clarification or correction.
- 6.2 Addenda notification will be made available to all registered vendors immediately via e-mail for inspection on-line.
- 6.3 No formal bid addendums will be issued later than forty-eight (48) hours prior to the date and time for receipt of formal bids, except an addendum withdrawing the invitation to bid, or an addendum which includes postponement of the bid.

7. ANTI-LOBBYING PROVISION

- 7.1 During the period between the advertised date and the contract award, Bidders, including their agents and representatives, shall not directly discuss or promote their bid with any member of the County Board or County staff except in the course of County-sponsored inquiries, briefings, interviews, or presentations, unless requested by the County.

8. BRAND NAMES

- 8.1 Wherever in the specifications or bid that brand names, manufacturer, trade name, or catalog numbers are specified, it is for the purpose of establishing a grade or quality of material only; and the term "or equal" is deemed to follow.
- 8.2 It is the Bidder's responsibility to identify any alternate items offered in the bid, and prove to the satisfaction of the County that said item is equal to, or better than, the product specified.
- 8.3 Bids for alternate items shall be stated in the appropriate space on the E-Bid form. Bidders MUST attach to its bid documents in the Vendor Attachment Section of the E-Bid, a statement identifying the manufacturer and brand name of each proposed alternate, plus a complete description of the alternate items including illustrations, performance test data and any other information necessary for an evaluation.
- 8.4 The Bidder must indicate any variances and explain by item number from the bidding document no matter how slight.
- 8.5 If variations are not stated in the bid, it will be assumed that the item being bid fully complies with the County's bidding documents.

9. DEMONSTRATIONS/SAMPLES

- 9.1 Bidders shall demonstrate the exact item(s) proposed within seven (7) calendar days from receipt of such request from the County.
- 9.2 Such demonstration can be at the County delivery location or a surrounding community.
- 9.3 If items are small and mailable, and the Bidder is proposing an alternate product, the Bidder shall supply a sample of the exact item. Samples will be returned at Bidder's expense after receipt by the County of acceptable goods. The Bidder must indicate how samples are to be returned.

10. DELIVERY (Non-Construction)

- 10.1 Each Bidder shall state on the bid the date upon which it can make delivery of all equipment or merchandise. Time required for delivery is hereby made an essential element of the bid.
- 10.2 The County reserves the right to cancel orders, or any part thereof, without obligation, if delivery is not made within the time(s) specified on the bid.
- 10.3 All bids shall be based upon inside delivery of the equipment or merchandise F.O.B. to the County at the location specified by the County, with all transportation charges paid.
- 10.4 At the time of delivery, a designated Lancaster County employee will sign the invoice/packing slip. The signature will only indicate that the order has been received and the items actually delivered agree with the delivery invoice. This signature does not indicate all items meet specifications, were received in good condition and/or that there is not possible hidden damage or shortages.

11. WARRANTIES, GUARANTEES AND MAINTENANCE

- 11.1 Copies of the following documents, if requested, shall accompany the bid proposal for all items being bid:
 - 11.1.1 Manufacturer's warranties and/or guarantees.
 - 11.1.2 Bidder's maintenance policies and associated costs.
- 11.2 As a minimum requirement of the County, the Bidder will guarantee in writing that any defective components discovered within a one (1) year period after the date of acceptance shall be replaced at no expense to the County. Replacement parts of defective components shall be shipped at no cost to the County. Shipping costs for defective parts required to be returned to the Bidder shall be paid by the Bidder.

12. ACCEPTANCE OF MATERIAL

- 12.1 All components used in the manufacture or construction of materials, supplies and equipment, and all finished materials, shall be new, the latest make/model, of the best quality, and the highest grade workmanship.
- 12.2 Material delivered under this bid shall remain the property of the Bidder until:
 - 12.2.1 A physical inspection and actual usage of the material is made and found to be acceptable to the County; and
 - 12.2.2 Material is determined to be in full compliance with the bidding documents and accepted bid.
- 12.3 In the event the delivered material is found to be defective or does not conform to the bidding documents and accepted bid, the County reserves the right to cancel the order upon written notice to the Bidder and return materials to the Bidder at Bidder's expense.
- 12.4 Awarded Bidder shall be required to furnish title to the material, free and clear of all liens and encumbrances, issued in the name of the Lancaster County, Nebraska, as required by the bidding documents or purchase orders.
- 12.5 Awarded Bidder's advertising decals, stickers or other signs shall not be affixed to equipment. Vehicle mud flaps shall be installed blank side out with no advertisements. Manufacturer's standard production forgings, stampings, nameplates and logos are acceptable.

13. BID EVALUATION AND AWARD

- 13.1 The electronic signature shall be considered an offer on the part of the Bidder. Such offer shall be deemed accepted upon issuance by the County of purchase orders, contract award notifications, or other contract documents appropriate to the work.
- 13.2 No bid shall be modified or withdrawn for a period of ninety (90) calendar days after the time and date established for receiving bids, and each Bidder so agrees in submitting the bid.
- 13.3 In case of a discrepancy between the unit prices and their extensions, the unit prices shall govern.
- 13.4 The bid will be awarded to the lowest responsive, responsible Bidder whose bid will be most advantageous to the County, and as the County deems will best serve the requirements and interests of the County.
- 13.5 The County reserves the right to accept or reject any or all bids; to request rebids; to award bids item-by-item, with or without alternates, by groups, or "lump sum"; to waive irregularities and technicalities in bids; such as shall best serve the requirements and interests of the County.
- 13.6 In order to determine if the Bidder has the experience, qualification, resources and necessary attributes to provide the quality workmanship, materials and management required by the plans and specifications, the Bidder may be required to complete and submit additional information as deemed necessary by the County. Failure to provide the information requested to make this determination may be grounds for a declaration of non-responsive with respect to the Bidder.
- 13.7 The County reserves the right to reject irregular bids that contain unauthorized additions, conditions, alternate bids, or irregularities that make the bid incomplete, indefinite or ambiguous.
- 13.8 Any governmental agency may piggyback on any contract entered into from this bid.

14. INDEMNIFICATION

- 14.1 The Bidder shall indemnify and hold harmless, to the fullest extent allowed by law, the County, its agents, officers, employees and representatives from and against all claims, demands, suits, actions, payments, liability, judgements and expenses (including court-ordered attorney's fees), arising out of or resulting from the performance of the contract that results in bodily injury, sickness, disease, death, civil rights liability, or injury to or destruction of tangible property, including the loss of use resulting therefrom, and that are caused in whole or in part by the Bidder, its employees, agents, any subcontractor, anyone directly or indirectly employed by them, or anyone for whose acts any of them may be liable. This section will not require the Bidder to indemnify or hold harmless the County for any losses, claims, damages and expenses arising out of or resulting from the sole negligence of the County, its agents, employees, or representatives.
- 14.2 In any and all claims against the County or any of its members, officers or employees by an employee of the Bidder, any subcontractor, anyone directly or indirectly employed by any of them or by anyone for whose acts made by any of them may be liable, the indemnification obligation under paragraph 14.1 shall not be limited in any way by any limitation of the amount or type of damages, compensation or benefits payable by or for the Bidder or any subcontractor under worker's compensation acts, disability benefit acts or other employee benefit acts.

15. TERMS OF PAYMENT

- 15.1 Unless stated otherwise, the County will begin processing payment within thirty (30) calendar days after all labor has been performed and all equipment or other merchandise has been delivered, and all such labor and equipment and other materials have met all contract specifications.

16. LAWS

- 16.1 The laws of the State of Nebraska shall govern the rights, obligations, and remedies of the parties under this bid and any contract reached as a result of this process.
- 16.2 Bidder agrees to abide by all applicable local, state and federal laws and regulations concerning the handling and disclosure of private and confidential information concerning individuals and corporations as to inventions, copyrights, patents and patent rights.
- 16.3 The Bidder agrees to hold the County harmless from any claims resulting from the Bidder's unlawful disclosure or use of private or confidential information.

17. EQUIPMENT TAX ASSESSMENT

17.1 Any bid for public improvement shall comply with Nebraska Revised Statutes 77-1323 and 77-1324. Indicating; every person, partnership, limited liability company, association or corporation furnishing labor or material in the repair, alteration, improvement, erection, or construction of any public improvement shall sign a certified statement which will accompany the contract. The certified statement shall state, stating that all equipment to be used on the project, except that acquired since the assessment date, has been assessed for taxation for the current year, giving the county where assessed.

18. AFFIRMATIVE ACTION

18.1 Each Bidder agrees that it will not discriminate against any employee or applicant for employment because of race, color, religion, sex, national origin, ancestry, disability, age, or marital status.

18.2 The successful Bidder will be required to comply with the provisions of the County's Affirmative Action Policy.

18.3 The Equal Opportunity Officer will determine compliance or non-compliance with the County's Affirmative Action Policy upon a complete and substantial review of successful Bidder's equal opportunity policies, procedures and practices.

18.4 The County provides equal opportunity for all Bidders and encourages minority businesses, women's businesses and locally owned business enterprises to participate in our bidding process.

19. INSURANCE

19.1 All Bidders shall take special notice of the insurance provisions required for all County contracts (see Insurance Clause for All County Contracts).

20. EXECUTION OF CONTRACT

20.1 Depending on the type of service provided, one of the following methods will be employed. The method applicable to this contract will be checked below:

a. PURCHASE ORDER, unless otherwise noted.

1. This contract shall consist of a Lancaster County Purchase Order.

2. A copy of the Bidder's bid response (or referenced bid number) attached and that the same, in all particulars, becomes the contract between the parties hereto: that both parties thereby accept and agree to the terms and conditions of said bid documents.

b. CONTRACT, unless otherwise noted.

1. County will furnish 2 copies of the Contract to the successful Bidder who shall prepare attachments as required. Insurance as evidenced by a Certificate of Insurance (as required), surety bonds properly executed (as required), and Contract signed and dated.

2. The prepared documents shall be returned to the Purchasing Office within 10 days (unless otherwise noted).

3. The County will sign and date the Contract and submit the Contract to the County Board of Commissioners for approval and signature.

4. Upon approval and signature, the County will return one copy to the successful Bidder.

21. TAXES AND TAX EXEMPTION CERTIFICATE

21.1 The County is generally exempt from any taxes imposed by the State or Federal Government. A Tax Exemption Certificate will be provided as applicable.

22. E-VERIFY

22.1 In accordance with Neb. Rev. Stat. 4-108 through 4-114, the contractor agrees to register with and use a federal immigration verification system, to determine the work eligibility status of new employees performing services within the state of Nebraska. A federal immigration verification system means the electronic verification of the work authorization program of the Illegal Immigration Reform and Immigrant Responsibility Act of 1996, 8 U.S.C. 1324 a, otherwise known as the E-Verify Program, or an equivalent federal program designated by the United States Department of Homeland Security or other federal agency authorized to verify the work eligibility status of a newly hired employee pursuant to the Immigration Reform and Control Act of 1986. The Contractor shall not discriminate against any employee or applicant for employment to be employed in the performance of this section pursuant to the requirements of state law and 8 U.S.C.A 1324b. The contractor shall require any subcontractor to comply with the provisions of this section. For information on the E-Verify Program, go to www.uscis.gov/everify.

SUPPLEMENTAL INSTRUCTIONS TO BIDDERS

Lancaster County Engineering Department Road and Bridge Construction Projects

This project shall be subject to and performed in accordance with the Instructions to Bidders, and with the revisions and amendments Listed below. In the event of a conflict with the Instructions to Bidders, the Supplemental Instructions listed below shall control and take precedence. Contractors must register as a vendor with City/County Purchasing to receive electronic bid (E-Bid) notices and must submit their bid via the E-Bid system. Please call (402) 441-8309 or (402) 441-8103 for assistance.

1. Section 1.1 shall be amended as follows: Sealed bids, formal and informal, are subject to the Instructions and General Conditions, and any Special Conditions set forth herein, and will be received in the Office of the Purchasing Agent, 440 So. 8th St., Lincoln, NE 68508, until the bid closing date and time indicated for furnishing Lancaster County the materials, supplies, equipment or services shown in the written specifications and electronic bid request.
2. Section 1.3 is not applicable to this project.
3. Section 5.1 shall be amended as follows: Bidders shall promptly notify the Lancaster County Engineering Department of any ambiguity, inconsistency, or error which they may discover upon examination of the specification documents.
4. Section 8 is not applicable to this project.
5. Section 9 is not applicable to this project.
6. Section 10 is not applicable to this project.
7. Section 11 is not applicable to this project
8. Section 12 is not applicable to this project.
9. Section 13.5 shall be amended as follows: It is the intent of this bid to receive proposals and award a contract for all the construction work shown on the plans. However, the County reserves the right and will be free to evaluate the proposals based on the low bids for a combination of any or all parts as the County sees fit or desires. The bidder must bid all items on the proposal(s). All work awarded will be awarded to one and only one bidder.
10. Section 13.8 is not applicable to this project.
11. Section 15 is not applicable to this project.
12. The following sections are added to the Instructions to Bidders:

STANDARD SPECIFICATIONS. The work as detailed on the plans shall be completed in accordance with the requirements of the 2011 City of Lincoln Standard Specifications for Municipal Construction, as supplemented by the Nebraska Department of Road's 2007 Standard Specifications for Highway Construction. The 2011 City of Lincoln Standard Specifications for Municipal Construction and the Nebraska Department of Road's 2007 Standard Specifications for Highway Construction (NDOR Standard Specifications), including all amendments, Supplemental Specifications and additions thereto effective at the date of the contract, the Special Provisions, plans, and all supplementary documents are essential parts of the contract.

BID DOCUMENTS. Copies of the Proposal, Specifications (Standard Specifications, Special Provisions, General Requirements, etc.), Plans (if required) and other document forms may be viewed at the office of the County Engineer or may be downloaded via the City/County e-bid process. Bidders are required to examine the same and satisfy themselves that all requirements are fully understood. Bidders are encouraged to personally inspect the location of the project upon which they are bidding.

QUALIFICATION OF BIDDERS. The bidder shall either be currently qualified with the Nebraska State Department of Roads for the group or groups of work to be bid on this contract or the bidder shall provide proof of responsibility to the satisfaction of Lancaster County. Generally, proof of responsibility shall consist of providing a brief resume of work successfully completed by the bidder that is similar to the type of work being bid. Additional information may be required by the County in order to determine a prospective bidder's qualifications.

All bidders shall complete the Contractor Work Resume form provided herein and attach it to the E-Bid in the "Response Attachment" section. The resume shall include projects which are similar to the type of work being bid for which the bidder had direct control over and was charged with full responsibility of the outcome.

SUBLETTING OR ASSIGNING THE CONTRACT. The bidder's attention is directed to Section 108.01 of the Standard Specifications regarding assignment or subletting contracts.

Project # 17-05 Pavement Striping



Striping Legend



CL & Edge Paint

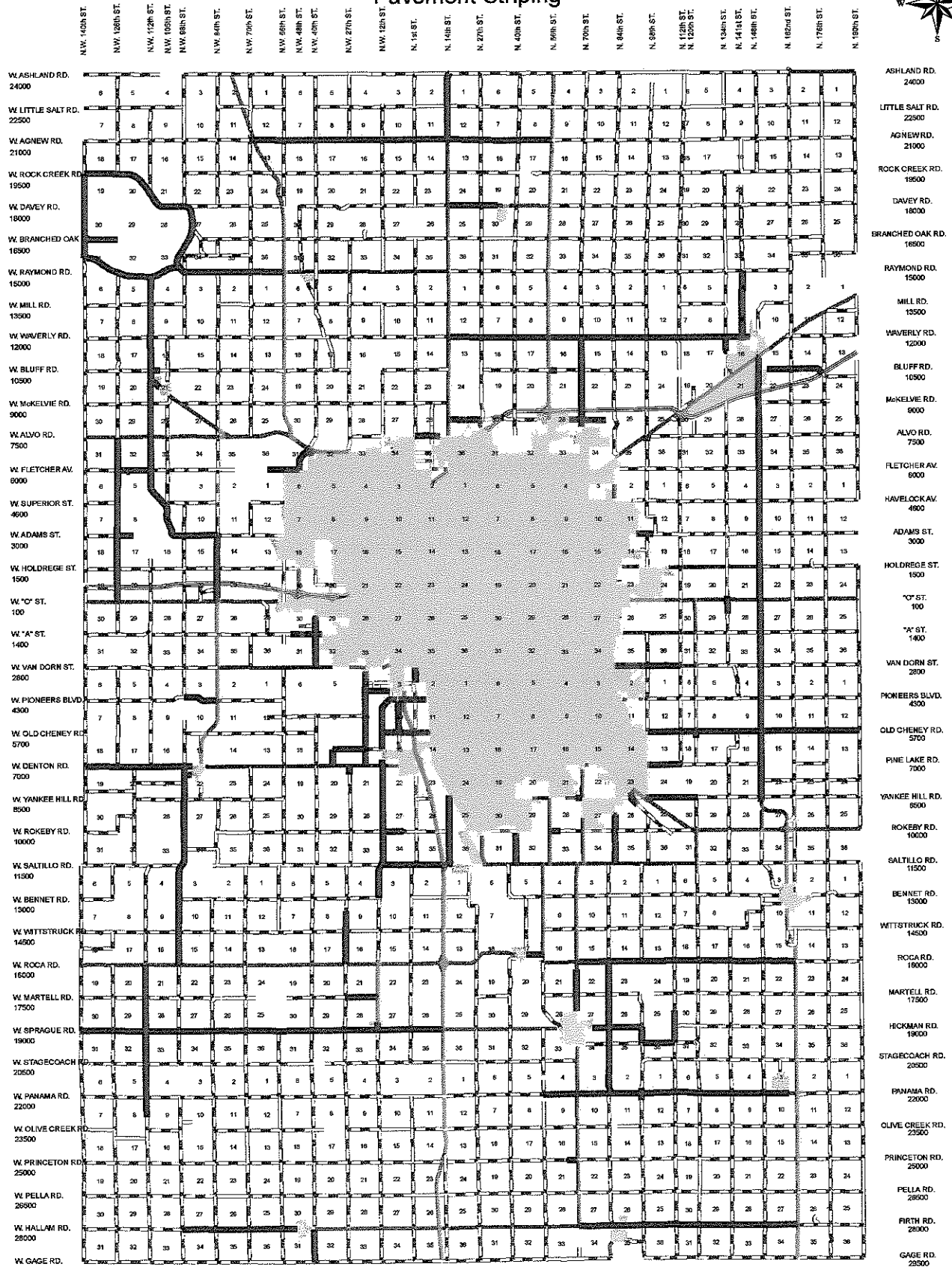

City of Lincoln/Lancaster County (Lincoln Purchasing) Supplier Response

Bid Information		Contact Information		Ship to Information
Bid Creator	Robert Walla Purchasing Agent	Address	Purchasing\City & County 440 S. 8th St. Lincoln, NE 68508	Address
Email	rwalla@lincoln.ne.gov	Contact	Robert Walla Asst. Purchasing Agent	Contact
Phone	1 (402) 441-8309	Department		Department
Fax	1 (402) 441-6513	Building		Building
Bid Number	17-049	Floor/Room		Floor/Room
Title	Pavement Striping - Project No. 17-05 (County Engineer)	Telephone	1 (402) 441-8309	Telephone
Bid Type	Bid	Fax	1 (402) 441-6513	Fax
Issue Date	2/1/2017 11:01 AM (CT)	Email	rwalla@lincoln.ne.gov	Email
Close Date	2/22/2017 12:00:00 PM (CT)			

Supplier Information

Company Straight-Line Striping, Inc.
Address 423 Ponderosa Dr.

 Grand Island, NE 68803
Contact Casey Clausen
Department
Building
Floor/Room
Telephone (308) 384-4638
Fax (308) 381-7194
Email gi_jerome@hotmail.com
Submitted 2/21/2017 02:40:34 PM (CT)
Total \$214,990.00

By submitting your response, you certify that you are authorized to represent and bind your company.

Signature Casey Jerome Clausen

Email gi_jerome@hotmail.com

Supplier Notes

Bid Notes

Vendors are strongly encouraged to send the insurance requirements and endorsement information to their insurance agent prior to bid close in order to expedite the contract execution process.

Bid Activities

Date	Name	Description
2/22/2017 12:00:00 PM (CT)	Intent to Bid - General Contractor	If you intend to bid as a Sub Contractor, select "No, I do not intend to respond to this opportunity" in the Response Intent Box, click Save. Click "?Intent" a second time, select "Yes, I intend to respond to this opportunity" in the Response Intent Box, click Save.

Bid Messages

Bid Attributes

Please review the following and respond where necessary

#	Name	Note	Response
1	Instructions to Bidders	I acknowledge reading and understanding the Instructions to Bidders.	Yes
2	Supplemental Instructions to Bidders	I acknowledge reading and understanding the Supplemental Instructions to Bidders.	Yes
3	NDOR Standard Specs for Hwy Construction	I acknowledge reading and understanding the current Nebraska Department of Road's Standard Specifications for Highway Construction Supplemental Specifications to the Standard Specifications for Highway Construction, view at: http://www.dor.state.ne.us/ref-man/	Yes
4	Work Resume Form	I have attached my Contractor Work Resume Form to this bid if my company has not completed work for Lancaster County in the last 3 years.	Yes
5	Contractor Project Schedule	The County prefers to have the Contractor Project Schedule Form attached to this bid.	(No Response Required)
6	Special Provisions	I acknowledge reading and understanding the Special Provisions.	Yes
7	Sample Contract	I acknowledge reading and understanding the Contract Agreement Forms.	Yes
8	Bonds	I acknowledge that the Performance Bond and Payment Bond in the amount of 100% of the Contract amount will be required with the signed contract upon award of this job.	Yes
9	Tax Exempt Certification Forms	Materials being purchased in this bid are tax exempt and unit prices are reflected as such. A Purchasing Agent Appointment form and a Exempt Sales Certificate form shall be issued with contract documents. (Note: State Tax Law does not provide for sales tax exemption for proprietary functions for government, thereby excluding the purchases of pipes to be installed in water lines and purchase of water meters.)	Yes
10	Tax Assessment Form	I acknowledge reading and understanding the Tax Assessment Form will be required with the contract.	Yes
11	Insurance Requirements and Endorsements	Vendor agrees to the applicable terms listed in the Insurance Clause document including the submission of the Certificate of Accord and the following endorsements: <ol style="list-style-type: none"> 1. Additional Insured - Lancaster County. 2. Workers Compensation - Waiver of Subrogation. <p>Insurance Certificate and required Endorsements are required at time of contract execution by the vendor.</p> <p>Vendors are strongly encouraged to send the insurance requirements and endorsement information to their</p>	Yes

insurance agent prior to bid close in order to expedite the contract execution process.

- | | | | |
|----|------------------------------|--|---------------------------|
| 12 | Bid Bond Submission | I acknowledge and understand that my bid will not be considered unless a bid bond or certified check in the sum of five percent (5%) of the total amount of the bid is made payable to the order of the County Treasurer as a guarantee of good faith prior to the bid opening. The bid security may be scanned and attached to the 'Response Attachments' section of your response or faxed to the Purchasing Office (402)441-6513. The original bond/check must then be received in the Purchasing Office, 440 S. 8th Street, Ste. 200, Lincoln, NE 68508 within three (3) days of bid closing.
YOU MUST INDICATE YOUR METHOD OF BID BOND SUBMISSION IN BOX TO RIGHT! | I have faxed my bid bond. |
| 13 | Barricade and Detour Plans | I acknowledge reading and understanding the Barricade Plans and Detour Plans. | Yes |
| 14 | Unit Price Rules | I acknowledge the Excel spreadsheet is attached to this bid in the Response Attachment Section. The unit price of the Excel Spreadsheet takes precedence over the total submitted in Line Items. | Yes |
| 15 | Project Dates | The Contractor agrees that the Work in this Contract shall begin on June 5, 2017 or as soon after the Notice to Proceed as is necessary for the Contractor to complete the Work within the number of calendar days allowed and prior to the stated completion date. The completion date shall be 68 calendar days after the beginning or construction shall be completed no later than August 11, 2017. | Yes |
| 16 | U.S. Citizenship Attestation | Is your company legally considered an Individual or Sole Proprietor: YES or NO

As a Vendor who is legally considered an Individual or a Sole Proprietor I hereby understand and agree to comply with the requirements of the United States Citizenship Attestation Form, available at:
http://www.sos.ne.gov/business/notary/citizenforminfo.html

All awarded Vendors who are legally considered an Individual or a Sole Proprietor must complete the form and submit it with contract documents at time of execution.

If a Vendor indicates on such attestation form that he or she is a qualified alien, the Vendor agrees to provide the US Citizenship and Immigration Services documentation required to verify the Vendor's lawful presence in the United States using the Systematic Alien Verification for Entitlements (SAVE) Program.

Vendor further understands and agrees that lawful presence in the United States is required and the Vendor may be disqualified or the Contract terminated if such lawful presence cannot be verified as required by Neb. Rev. Stat. 4-108. | no |
| 17 | Employee Class Act Affidavit | I acknowledge if awarded the contract I will abide by the law, notarize and attach the Employee Classification Act Affidavit to my contract. | Yes |
| 18 | Contact | Name of person submitting this bid: | Casey Clausen, President |
| 19 | Electronic Signature | Please check here for your electronic signature. | Yes |

Line Items

#	Qty	UOM	Description	Response
1	200	Miles	5" Permanent Pavement Marking Paint - Project No. 17-05 BID PER MILE	\$1,074.95

Item Notes:

Supplier Notes:

2	1	Lump Sum	Mobilization - Project No. 17-05	\$0.00
---	---	----------	----------------------------------	--------

Item Notes:

Supplier Notes:

Response Total: \$214,990.00

SPECIAL PROVISIONS FOR PROJECT NO. 17-05; PAVEMENT STRIPING

Page 1

GENERAL INFORMATION

The following are revisions, amendments and/or supplements to the Standard Specifications:

Section 101, Article 101.0317

Commission. Shall mean the Board of County Commissioners of Lancaster County, Nebraska.

Section 101, Article 101.0321

The word "Pre-Qualified" shall be eliminated from the definition of the term Contractor.

Section 101, Article 101.0328

Department. Shall mean the Lancaster County Engineering Department.

Section 101, Article 101.0335

Engineer. Shall mean the Lancaster County Engineer.

Section 101, Article 101.0349

The word "Pre-Qualified" shall be eliminated from the definition of the term Letting.

Section 101, Article 101.0383

State. Shall mean Lancaster County, Nebraska.

Section 102, Article 102.01

This section of the Standard Specification is null and void.

Section 102, Article 102.02

This section of the Standard Specification is null and void and will be replaced with the following:

Qualification of bidders with the State of Nebraska on County projects is desirable but not mandatory. If in the opinion of the County Engineer a bidders' experience, equipment or financial condition is in doubt, he may request and the bidders will provide information documenting the bidder qualifications prior to awarding a contract to said bidder.

Section 102, Article 102.05

This section of the Standard Specification is null and void (see E.E.O. requirements in Instructions to Bidders).

Section 102, Article 102.06

This section of the Standard Specification is null and void.

Section 102, Article 102.08

This section of the Standard Specification is null and void.

Section 102, Article 102.10 Paragraphs 1 and 2

These sections of the Standard Specification are null and void and will be replaced with the following:

All bids will be submitted using the City of Lincoln/Lancaster County Purchasing Agents' e-bid system. Facsimile or e-mail bids are not acceptable.

Section 102, Article 102.11 Paragraphs 1(b), 1(c), 1(e), 1(f), 1(g), 1(h), and 1(i).

These sections of the Standard Specifications are null and void.

Section 102, Article 102.12 Paragraph 2(a)

The sentence which references "Annual Bid Bond" is null and void.

Section 102, Article 102.12

This section of the Standard Specifications is null and void and will be replaced with the requirements in Section 1 of the Instructions to Bidders.

Section 102, Article 102.15

This section of the Standard Specifications is null and void and will be replaced with the requirements in Section 2 of the Instructions to Bidders.

Section 103, Article 103.01

The reference to the "Director" in the first sentence will mean Lancaster County Board of Commissioners. The reference to "Thirty Days" in the second sentence will be amended to 90 days.

SPECIAL PROVISIONS FOR PROJECT NO. 17-05; PAVEMENT STRIPING

Page 2

Section 103, Article 103.04

This section of the Standard Specifications is null and void and will be replaced with the Paragraph titled "Performance, Labor, and Material Payment Bond" in these Supplemental Special Provisions.

Section 103, Article 103.05

This section of the Standard Specifications is null and void and will be replaced with Paragraph 20 of the Instructions to bidders.

Section 103, Article 103.06 Paragraph 1(a) and 1(b)

This section of the Standard Specifications is null and void and will be replaced with Paragraph 20 of the Instructions to Bidders.

Section 103, Article 103.06 Paragraph 2(b)

This section of the Standard Specification will be amended to read as follows:

- b. Proceed with the execution of the contract after the 10 day period when all required documents have been correctly submitted.

Section 105, Article 105.02 Paragraph 7

The address for submittal of shop drawings and working drawings will be amended to:

Lancaster County Engineering Department
444 Cherrycreek Road, Bldg "C"
Lincoln, NE 68528
Attn: Shop Drawings

Section 107, Article 107.12

This section of the Standard Specification is null and void.

Section 107, Article 107.13

The insurance coverages and limitations specified in this portion of the Standard Specification will be superseded by the form entitled "Insurance Clause for all County Contracts". All other requirements of this portion of the Standard Specification will remain unchanged.

DELIVERY (Construction)

All bids shall be based on the delivery schedule specified in the Special Provisions and/or Project Schedule Form. Time required for delivery of labor, materials, services, etc... as specified above is hereby made an essential element of the bid.

CONTRACT TIME PERIOD

The bidder proposes to furnish all necessary equipment, tools, machinery, apparatus, and other means of construction; to do all work and to furnish all materials and labor necessary to complete the work in accordance with the Plans, Specifications, and Special Provisions now on file in the office of the Lancaster County Engineer; to commence said work on June 5, 2017, and to complete all work on or before August 11, 2017. This project will be considered a calendar day project. (68 Calendar days)

A contractor may begin work on the contract before the date specified herein, provided the contractor has received a notice to proceed from the County, such change is acceptable to the County Engineer, and the contractor has received written permission from the County to do so.

PROPOSAL EVALUATION

The unit prices specified herein shall prevail when evaluating the proposals to determine the successful bidder. Should an error be discovered in the estimated quantities during the advertisement period, every effort will be made to issue an addendum correcting the discrepancy. If, in the opinion of the County Engineer an addendum cannot be issued prior to the filing of the proposals, the County reserves the right to evaluate the proposals based on the known quantities at the time the proposals are opened.

SPECIAL PROVISIONS FOR PROJECT NO. 17-05; PAVEMENT STRIPING

Page 3

BID BOND

The bidder will furnish a Bidder's Bond for not less than five percent (5%) of the total bid made payable to the County Treasurer of Lancaster County, Nebraska, which is to be retained as liquidated damages in case the bidder fails to enter into a Contract with sufficient bond for the full amount of the Contract price within ten (10) calendar days from the date of the award of the Contract to the bidder.

PERFORMANCE, LABOR, AND MATERIAL PAYMENT BOND. Within ten (10) calendar days after the award of the bid, the successful bidder must execute a written contract between the bidder and the County; such contract will incorporate the County's contract documents and be on forms provided by the County. Failure to enter into such a contract with the County within such time period will cause a forfeiture of bidder's bid security to the County as fully liquidated damages. Also within such time period, the successful bidder must furnish on forms provided by the County a Performance and Labor and Material Payment Bond in the sum of one hundred percent (100%) of the contract price, executed by the bidder and a corporate surety company authorized to transact business in the State of Nebraska. Such bond shall be conditioned upon the faithful performance of all terms and conditions of the contract documents, including the holding harmless of the County from failure to do so and including the making good of any and all guarantees which the contract documents may require; and, such bond shall be further conditioned upon the payment of all laborers and materialmen who provide labor, materials, etc. actually used or rented in the performance of the contract, including insurance premiums and interest.

SALE TAX EXEMPT STATUS

The Contractor is hereby advised that this project is sales tax exempt. The Contractor will be issued a Purchasing Agent Appointment and Sales Tax Exempt Certificate for the work on this project.

RETAINED EARNINGS

Section 109.07, 3(b) of the Standard Specifications is void.

PAVEMENT STRIPING LOCATION

See Location Map.

PERMANENT PAVEMENT MARKING

The work shall consist of painting centerline, edgeline and all other miscellaneous lines on the roadway at the locations detailed in the plans and these Special Provisions. These specifications cover the application of traffic paint and Type I beads on bituminous or portland cement concrete pavements.

MATERIALS – PAINT

The paint shall be white or yellow traffic paint capable of receiving and holding glass beads for producing reflectorized traffic markings. The paint shall be furnished ready mixed. The paint for the striping shall be acrylic waterborne traffic paint conforming to the specification below.

The paint shall be compatible with Type I drop-on beads. The paint shall be applied according to the manufacturer's recommendation unless specifically directed in writing by the Engineer. The traffic paint shall bind the glass beads in such a manner as to produce maximum adhesion, reflection and refraction.

The paint shall show proper capillary action at the interstices existing between the beads to provide good anchorage and refraction. The paint shall be homogeneous, well ground, shall not settle badly or cake in the container and shall readily break up with a paddle to a smooth uniform consistency. It shall be free from water, dirt, and other foreign matter and shall dry within the specified period to a good, tough, serviceable film. Any paint which shall have livered or in any way hardened or thickened in the container, or in which the pigment shall have settled out so that it cannot be remixed to a smooth uniform suspension of useable consistency shall be disposed of by the Contractor at no expense to the County.

The Contractor shall submit certified test results for all tests stipulated in this specification including volatile organic content of the mixed paint. To permit easy reference and identification, the project number, type of paint, manufacturer code number, batch number, color and date of manufacture shall be included.

Raw materials and/or finished products, which fail to meet any requirement of these specifications, shall be subject to rejection.

ACRYLIC RESIN WATERBORNE LEAD FREE TRAFFIC PAINT

The paint shall contain no lead and/or chromium and shall have limited Volatile Organic Content, as noted herein.

PIGMENT

Titanium Dioxide - This material shall comply with the latest revision of the specification for Titanium Dioxide Pigments, ASTM D 476, Type II, Rutile. Hiding power of the titanium dioxide shall be greater than or equal to the standard sample when tested in the standard formula.

Pigment Yellow 65 - This material will only be allowed from Clariant, Engelhard, Dominion or Sun Chemical.

Yellow Iron Oxide - This material shall comply with the latest revision of ASTM D 768 and will only be allowed from Harcors (YLO-2288D) or OSO Iron Oxide (OS0440).

Calcium Carbonate - This material shall comply with the latest revision of the specification for Calcium Carbonate Pigments, ASTM D 1199, Type GC, Grade 1, with minimum 95% Calcium Carbonate and Type PC, minimum 98% Calcium Carbonate.

VEHICLE

Acrylic Emulsion Polymer - The non-volatile portion of the vehicle shall be Rohm and Haas Rhoplex Fastrack 3427 or Dow Chemical DT 250 NA.

Methyl Alcohol - ASTM D 1152 Specific Gravity, 20/20°C, 0.791 to 0.794.

Propylene Glycol - ASTM D 5164

Water - Potable.

MISCELLANEOUS MATERIALS

The type and manufacture of the following materials shall be left to the discretion of the manufacturer as long as the finished product meets the traffic paint requirements as specified herein:

- | | |
|------------|-------------------|
| Dispersant | Rheology Modifier |
| Surfacant | Coalescent |
| Defoamer | Preservative |

STANDARD FORMULATION

The following Standard Formulas shall be the basis for the paint. No variations will be permitted except for the replacement of volatiles lost in processing or those approved by the Engineer. Amounts are shown in pounds of material.

Color of Traffic Paint	White	Yellow
C. I. Pigment Yellow 65	---	50
Titanium Dioxide, Rutile Type II	100	40
Yellow Iron Oxide	---	2
Calcium Carbonate, Type PC	150	125
Calcium Carbonate, Type GC	430	450
Rheology Modifier	0.5*	0.3*
Acrylic Emulsion, 50% Solids	541	535
Coalescent	24	23
Defoamer	5	6
Dispersant	8	10
Surfactant	2	2
Methyl Alcohol	15	15
Propylene Glycol	15	14
Preservative	1.5	1.5
Water	10	15
Total Pounds	1,301	1,288.8

* Rheology Modifier amount may be varied by up to 0.1 pound to adjust viscosity to desired range.

PIGMENT COMPOSITION

Analysis of the extracted pigment shall conform to the following requirements:

	Percent by Weight of Pigment	
	White	Yellow
Organic Yellow 65	---	7.5* min.
Titanium Dioxide	13.4 min.	3 min.
Calcium Carbonate	86 max.	87 max.
Yellow Iron Oxide	---	0.3 min.

* To be determined by x-ray fluorescence, color spectrophotometry, or any other method the Engineer may choose.

PHYSICAL PROPERTIES

Total Solids, percent by weight	73.0 min.
Pigment, percent by weight	49.0 to 54.0
Vehicle, percent by weight	46.0 to 51.0
Non-volatile in vehicle, percent by weight	44 min.
Weight per Gallon, lbs., and/or by Split Weight	± 0.30 Theo ±0.10
Consistency, at 77°F, Krebs Units	83 to 98
Fineness of Grind, Hegman Scale	3 min.
Laboratory Dry Time, ASTM D711	10 minutes, max.
pH	9.6 min.
Drying Time, No-Tracking, minutes	3 max.
Drying Time, Dry Through, minutes	130 max.
Drying Time, No Pick Up, minutes	10 max.
Reflectance White	83 min.
Yellow	50 min.
Contrast Ratio, 15 mils wet	0.96 min.

DETAILED REQUIREMENTS

1. Condition in Container – The paint shall be finely ground; shall not show excessive settling; shall show no gelling, curdling, livering, caking, lumps, skins, or color separation and shall be easily dispersed with a hand paddle to a smooth, homogeneous state. After storage for periods up to 12 months from date of packaging, the pigment shall be readily dispersed and the consistency of the paint shall not have changed more than 5 KU (Krebs Units) from that of the freshly delivered paint.
2. Grind – The traffic paint shall have a grind of not less than 3 on the Hegman Scale when tested in accordance with ASTM D 1210.
3. Color - For white traffic paint, the color after drying shall be a flat white, free from tint, furnishing good opacity and visibility under both daylight and artificial light. For yellow, the color shall closely match Color 33538 of Federal Standard 595b and shall be ± 6% from the PR #1 chart central color when read over the black portion of a Leneta black and white paper chart (Central Color Coordinates $x = 0.5007$, $y = 0.4555$). Measurements shall be performed using a color spectrophotometer with a 45°/0° circumferential viewing geometry, illuminate "C", and an observer of 2°.
4. Reflectance - The daylight directional reflectance of the white traffic paint shall not be less than 83. The daylight directional reflectance for the yellow traffic paint shall not be less than 50. The paint shall be applied to a Leneta black and white paper chart at a wet film thickness of 15 mils. After drying 24 hours, measure the reflectance of the traffic paint over the black portion of the chart using a Hunter Lab color spectrometer or equal. (ASTM E 1347).
5. Contrast Ratio – The minimum contrast ratio for both white and yellow traffic paint shall be 0.96. The paint is applied on a Leneta black and white paper chart at a wet film thickness of 15 mils and dried for at least twenty-four hours. Using a color spectrometer the Reflectance (Y) values of the paint shall be obtained using a 45° viewing angle, a 2° observation angle and illuminate "C". Contrast Ratio is the ratio of the reflectance on a black square to that of an identical film on a white square.
6. Consistency – The waterborne traffic paint shall have a consistency of not less than 83 or more than 98 Krebs Units at 77°F. A Brookfield viscometer or equal with a paddletype rotor shall be used in accordance with Method 4287 of
7. Drying Time, No Pick Up – The waterborne paint shall be dry to no pickup in not more than 10 minutes. This laboratory drying time shall be determined in accordance with ASTM D 711. Paints shall be applied at a paint temperature of 77°F. The no pickup drying time of the paints in the field shall comply with the laboratory no pickup drying time requirements.

8. **Drying Time, No Tracking** - No tracking shall be the time in minutes required for the line to withstand the running of a standard automobile over the line at a speed of approximately 40 mph, simulating a passing procedure without tracking of the reflectorized line when viewed from a distance of 50 feet. The paint shall dry to no tracking conditions under traffic in three minutes maximum. When applied at a temperature of 50°F to 120°F at a wet film thickness of 15 mils with six pounds of glass beads per gallon of paint, this maximum drying time shall not be exceeded when the pavement surface temperature varies from 50°F to 120°F at a relative humidity of 80% or less.
9. **Drying Time, Dry Through** - The paint shall be applied to a non-absorbent substrate at a wet film thickness of 15 ± 1 mils and placed in a humidity chamber controlled at $90 \pm 5\%$ R.H. and $72.5 \pm 2.5^\circ\text{F}$. The dry through time shall be determined according to ASTM D1640, except that the pressure exerted shall be the minimum needed to maintain contact with the thumb and film.
10. **Spraying Properties** - The traffic paints (as received) shall have satisfactory spraying properties.
11. **Appearance of Dry Film** - The sprayed paints shall dry to a smooth, uniform finish free from roughness, grit, unevenness, and other surface imperfections. There shall be no bleeding, streaking, separation, blistering, wrinkling, or cracking.
12. **Bleeding** - The paint shall have a minimum bleeding ratio of 0.96 when tested in accordance with Federal Specification TT-P-1952D. The asphalt saturated felt shall conform to ASTM D 226 for Type I.
13. **Flexibility** - The paint shall show no cracking or flaking when tested in accordance with Federal Specification TT-P-1952D.
14. **Water Resistance** - The paint shall conform to Federal Specification TT-P-1952D. There shall be no blistering or appreciable loss of adhesion, softening, or other deterioration after examination.
15. **Dilution Test** - The paint shall be capable of dilution with water at all levels without curdling or precipitation such that the wet paint can be readily cleaned up with water only.
16. **Accelerated Package Stability** - (ASTM D 1849 & TT-P-1952D) Fill a clean 500 ML (1 pint) resin-lined friction-top can with thoroughly mixed sample. Measure the initial consistency. Close the can tightly to prevent evaporation loss. Store this can in an oven at a temperature of 52°C for two weeks. After two weeks, remove the can from the oven and allow it to cool to room temperature. Examine the paint for livering and hard settling. Hand stir the sample for 5 minutes to ensure uniform distribution. The paint shall show no caking, skinning, livering or hard settling. It shall be dispersible by hand stirring for 5 minutes to a smooth, homogeneous state. When compared to the initial consistency, the sample shall show no change greater than 5 Krebs Units after this heated storage period.

GLASS BEADS

The beads shall be glass beads to be applied on the wet film surface of traffic paint to improve the nighttime visibility of the pavement marking.

Glass beads for use with Acrylic Waterborne Traffic Paints or VOC Compliant Solvent based traffic paints shall be designated as AASHTO M 247 Type I Coarse Dual-Coated moisture resistant beads.

The beads, as delivered, shall be colorless, free from clumps, contain no extraneous material and shall flow freely when applied to traffic paint. The glass beads shall be highly resistant to the effects of weathering as determined by laboratory tests and field tests. The glass beads shall show good adherence to the paint binders and provide good night visibility throughout the useful life of the reflectorized paint.

The beads shall allow sufficient capillary action to form a firm embedment in typical traffic paint when dropped on a freshly applied paint film.

Type I Coarse Dual Coated Glass Beads shall meet the following requirements:

Imperfections. The glass beads shall have not more than 30 percent imperfect beads retained on any sieve. The total imperfect beads on all sieves shall not exceed 20 percent. Imperfect beads are defined as ovate or otherwise nonspherical in shape; two or more beads fused together; and beads which show turbidity, pitting, scratching, surface wrinkling, internal air bubbles, or other inclusions. The percentage of perfect beads and non-glass material shall be determined by microscopic inspection of a representative sample of not less than 500 beads. All particles in the sample shall be counted regardless of shape or material.

Index of Refraction. The glass beads shall have an index of refraction of not less than 1.50 when tested by the liquid immersion method at 25°C .

SPECIAL PROVISIONS FOR PROJECT NO. 17-05; PAVEMENT STRIPING

Page 7

Gradation. The drop on glass beads in a representative sample shall meet the following gradation requirement when tested in accordance with Standard Method of Test for Sieve Analysis of Glass Spheres, ASTM D 1214.

U.S. Standard Sieve No.	Sieve Opening Millimeters	Amount Passing, %
20	0.850	90-100
30	0.600	55-80
50	0.300	5-25
80	0.180	0-5

Moisture Resistance: The glass beads shall pass the "Moisture Resistance Test" as defined in AASHTO M 247-02(2002), Section 5.4.2.

Embedment Coating Test: The glass beads shall be tested for verification of silane presence/adhesion promoter, by performing the "Dansyl Chloride Test."

Bead Embedment: Apply traffic paint to a glass panel at a wet film thickness of 0.012 inch followed immediately by an application of glass beads dropped onto the surface of the paint. After drying for at least 24 hours, observe the amount of bead embedment with a 30-power microscope. At least 90% of the beads shall be embedded between 40% and 60%.

The Contractor shall submit certified test results indicating that the beads being submitted have passed all of the above noted tests. To permit easy reference and identification the project number, type of bead, manufacturer code number, batch number and date of manufacture shall be included.

Handling and Storage

The Contractor shall provide the equipment required to load and unload the required materials. No County equipment or staff will be available for use by the Contractor. The Contractor will be allowed to use County maintenance yards for storage sites for material and equipment. A map of County maintenance yards follows these Special Provisions.

Equipment

The equipment used for applying traffic marking paint and beads shall be a self-propelled applicator. The striper used for pavement marking shall:

1. Be capable of applying three lines simultaneously on the left side for centerline markings and/or one line on the right side of the unit for edgeline markings.
2. Be capable of applying the traffic marking paint 5" wide to a dry thickness of 12±1 mils that is uniform across the width and length of the stripe.
3. The reservoirs shall be equipped with agitators that keep the paint in a smooth and even mixture.
4. Be equipped with an automatic skip device that applies a stripe and gap of a specified length with a tolerance of three inches per cycle of skip. This tolerance shall not be accumulated in subsequent cycles. The striper shall be able to adjust the cycle while striping to allow matching the existing stripe.
5. Be capable of applying the traffic marking beads to the wet paint immediately after the application of the paint at a rate required in the plans and these Special Provisions. The bead applicator shall be equipped with an automatic shut off synchronized with the paint flow.

CONSTRUCTION METHODS

Pavement Surface Preparation

The roadway to be striped shall be cleaned of foreign matter that would prevent the paint from adhering to the roadway by County forces. The paint shall be applied to a dry pavement surface.

Traffic Control

The County will provide a vehicle to follow the striper alerting traffic to the striping work. Traffic cones may be necessary in some cases to prevent tracking of the paint and will be provided by the County.

Traffic will be maintained through the work area at all times.

Traffic shall be controlled through the work area until the pavement markings have dried sufficiently to prevent tracking.

Equipment not actively involved in applying pavement markings shall not be parked or stand within 20 feet of the edge of the roadway during day and 30 feet at night. This includes any preparation of equipment, filling reservoirs, mixing paint or cleaning of equipment.

Application of Marking Materials

Pavement marking materials as specified shall be applied with equipment meeting the specifications above. In those areas where there are curbed medians, the curbs shall be painted yellow. Where the area to be painted is an odd area hand sprayers and manual bead application is acceptable.

The paint shall be applied within the manufacturer's recommended temperature range. The paint shall not be applied when the wind prevents the Contractor from placing markings acceptable to the engineer. Striping shall be performed only during daylight hours.

The beads shall be applied at the rate of 6 pounds per gallon of paint applied. If application rates are not within the requirements, the marking application shall be stopped until corrections are made. The beads shall be applied evenly over the entire surface of the freshly applied paint. The paint shall be applied in such a manner as to follow the existing lines on the roadway. Typical striping details follow these Special Provisions. The paint shall be applied to a uniform dry thickness of 12 ± 1 mils and shall be $5 \pm 1/2$ " wide. The Engineer will take periodic samples to ensure the thickness and width of the stripe. Finished lines shall have well defined edges and lateral deviations shall not exceed two inches in 200 feet. Excessive overspray, as determined by the Engineer, will not be permitted. The dashed lines shall be within three inches of their intended length and intended placement. When placing new stripes the cycle of dashed line and gap shall not vary more than 3". This tolerance shall not be accumulated in subsequent cycles. Lines not meeting these requirements may, at the discretion of the Engineer, be ordered removed and replaced at no cost to the State. Removal, if required, shall be accomplished by sandblasting, shotblasting, hydro blasting or other methods approved by the Engineer.

METHOD OF MEASUREMENT AND BASIS OF PAYMENT

Permanent Pavement Marking Paint and Beads will be measured by the mile, excluding gaps, of line applied and accepted by the Engineer. The beads shall be subsidiary to items for which direct payment is made. Any striping ordered removed and replaced shall be done at no expense to the County. The pay item is 5" "Permanent Pavement Marking Paint" and the unit of measurement is the miles.

CONSTRUCTION SITE CONTROL

To the extent permitted by law, the County relinquishes control of the construction site to the Contractor and its Subcontractors during the period of construction. The construction, placement of barricades, and posting of warning signs in the area of construction will be the responsibility of the Contractor. This shall include the placement of construction equipment and any obstacles which are created as a result of the construction project. The placement of barricades and warning signs shall be in compliance with the current edition of the *Manual on Uniform Traffic Control Devices and the 2007 Edition of the Standard Specifications of Highway Construction of the State of Nebraska*. The placement of such barricades and signs shall be reviewed by the County Engineer's Office prior to commencement of the project to ensure compliance. To the extent permitted by law, the Contractor expressly accepts control of the construction site, such control shall include, but not be limited to, barricades, signs, road crossing, construction equipment and any obstacles created during construction of the project.

Nebraska Weed-Free Gravel / Borrow Pit Minimum Standards

Gravel / borrow area shall be free of noxious weeds or undesirable plant species identified in the following list and those weeds declared noxious within the state and county of destination.

1. Gravel/borrow material shall be inspected in the State/Province of origin by proper officials or authority.
2. Gravel/borrow material shall also be inspected in the area of origin (area shall include, but not limited to, surrounding ditches, top soil piles, gravel/sand piles, fence rows, roads, easement, right-of-way, working areas, storage areas, and a buffer zone surrounding the area.)
3. Gravel/borrow material shall be inspected prior to movement by the proper officials or authority.
4. Gravel/borrow area which contains any noxious weeds, or undesirable plant species, as identified in the following list, may be certified if the following requirements are met:
 - a) Area upon which the gravel/borrow material was mined was treated to prevent seed formation or seed ripening to the degree that there is no danger of dissemination of the seed, or any injurious portion thereof from such noxious weeds, or undesirable plant species, or the propagating parts of the plant are not capable of producing a new plant.
 - b) Noxious weed(s) or undesirable plant species was treated not later than rosette to bud stage, or boot stage for grass species.
 - c) Treatment method can include but is not limited to: 1) burning, 2) mowing, cutting or rouging, 3) mechanical methods, or 4) chemicals.
5. An inspection certificate shall document that the above requirements have been met based upon a reasonable and prudent visual inspection.

Minimum Guidelines for gravel / borrow material inspections:

The inspector will follow the following inspection procedures:

1. The entire border shall be walked or driven.
2. All storage areas, gravel/sand piles shall also be inspected and meet the standards.

3. Around all equipment, crushers, and working areas must be inspected to meet the standards.
4. Areas shall be inspected regularly at least twice a year in the growing season.
5. An inspector may not inspect gravel/borrow material of which said inspector has ownership or financial interest.

Nebraska Weed Free Forage Certification Standards List

Canada thistle	<i>Cirsium arvense</i>
Leafy spurge	<i>Euphorbia esula</i>
Musk thistle	<i>Carduus nutans</i>
Plumeless thistle	<i>Carduus acanthoides</i>
Diffuse knapweed	<i>Centaurea diffusa</i>
Spotted knapweed	<i>Centaurea maculosa</i>
Purple loosestrife	<i>Lythrum salicaria</i> and <i>L. virgatum</i> (including any cultivars and hybrids)
Saltcedar	<i>Tamarix ramosissima</i> Ledeb
Phragmites	<i>phragmites australis</i> , subspecies <i>australis</i>
Knotweeds	
• Japanese	<i>Fallopia japonica</i>
• Giant	<i>Fallopia sachalinensis</i>
Sericea lespedeza	<i>Lespedeza cuneata</i>

Lancaster County Weed Free Forage Certification Standards List

Common teasel	<i>Dipsacus fullonum</i>
Cutleaf teasel	<i>Dipsacus laciniatus</i>

NEBRASKA WEED-FREE GRAVEL / BORROW CERTIFICATION OF INSPECTION

NGCS/ LCWCA-15
Pit inspection history

____ 1st year
____ 2nd year
____ 3rd year
____ 4 or more years (specify)

Date ____ / ____ / ____

NGCS No. NE ____ / ____ / ____

STATE PERMIT # _____

Lancaster County Weed Control Authority. NE002-_____

This certifies that the gravel pit described herein, has been inspected according to the ***Nebraska** and ***Lancaster County** certification standards. The objective of the program is to help prevent and slow the speed of the Designated Noxious Weeds by providing gravel/borrow material that is free* of the potential for transport and dispersal of listed weed species.

Operator _____ Phone: _____

Mailing Address _____ City _____ State _____ Zip _____

Pit Location _____ County _____ Acres inspected _____

Material description: (Sand / Gravel / Rock / Top soil) _____

Level of certification: (check one)

A. ____ **EXCEEDS** requirements of the Nebraska and Lancaster County certification standards and contains only the specified gravel/borrow material with **no** nonnative plants noted.

B. ____ **MEETS** requirements of the Nebraska and Lancaster County certification standards. This gravel/borrow material contains variable amounts of annual weeds and/or other weeds **not listed** as prohibited or noxious per Nebraska or Lancaster County standards.

(Weeds noted): _____

C. ____ **MINIMUM** requirements of the Nebraska and Lancaster County certification standards are met. *This gravel/borrow material contains variable amounts of prohibited or noxious weed species which were immature, (no viable seed) when treated to prevent seed formation. These plant parts, although not usually desirable in the gravel/borrow material, are considered unable to begin new infestations.

(Weeds noted): _____

Additional comments: _____

D. ____ **FAILED** Explanation _____

REQUIREMENTS

Gravel/borrow material must be certified to the NAMWA certification standards and inspected by proper officials. Inspection shall include, but not limited to, surrounding ditches, top soil piles, gravel/sand piles, fence rows, roads, easement, right-of-way, working areas, storage areas and a buffer zone surrounding the area.

Certification shall be based on a reasonable and prudent visual inspection. This certification terminates on:

Date: ____ / ____ / ____

Certified by: _____ Title _____

*Nebraska State listed noxious weeds (see Gravel Pit Minimum Standards document)

*Lancaster County listed noxious weeds (see Gravel Pit Minimum Standards document)

- **Disclaimer: Certified gravel/borrow material may have viable seeds from previous years. Plant seed cannot be killed by registered pesticides. Certification consists of a prudent and visual inspection for that year (s) certification for this pit. Previous years may have had seed drop that can still be viable. This is a buyer beware program.**

COUNTY MAINTENANCE YARD LOCATIONS

PROJECT NO. 17-05

LANCASTER COUNTY, NEBRASKA

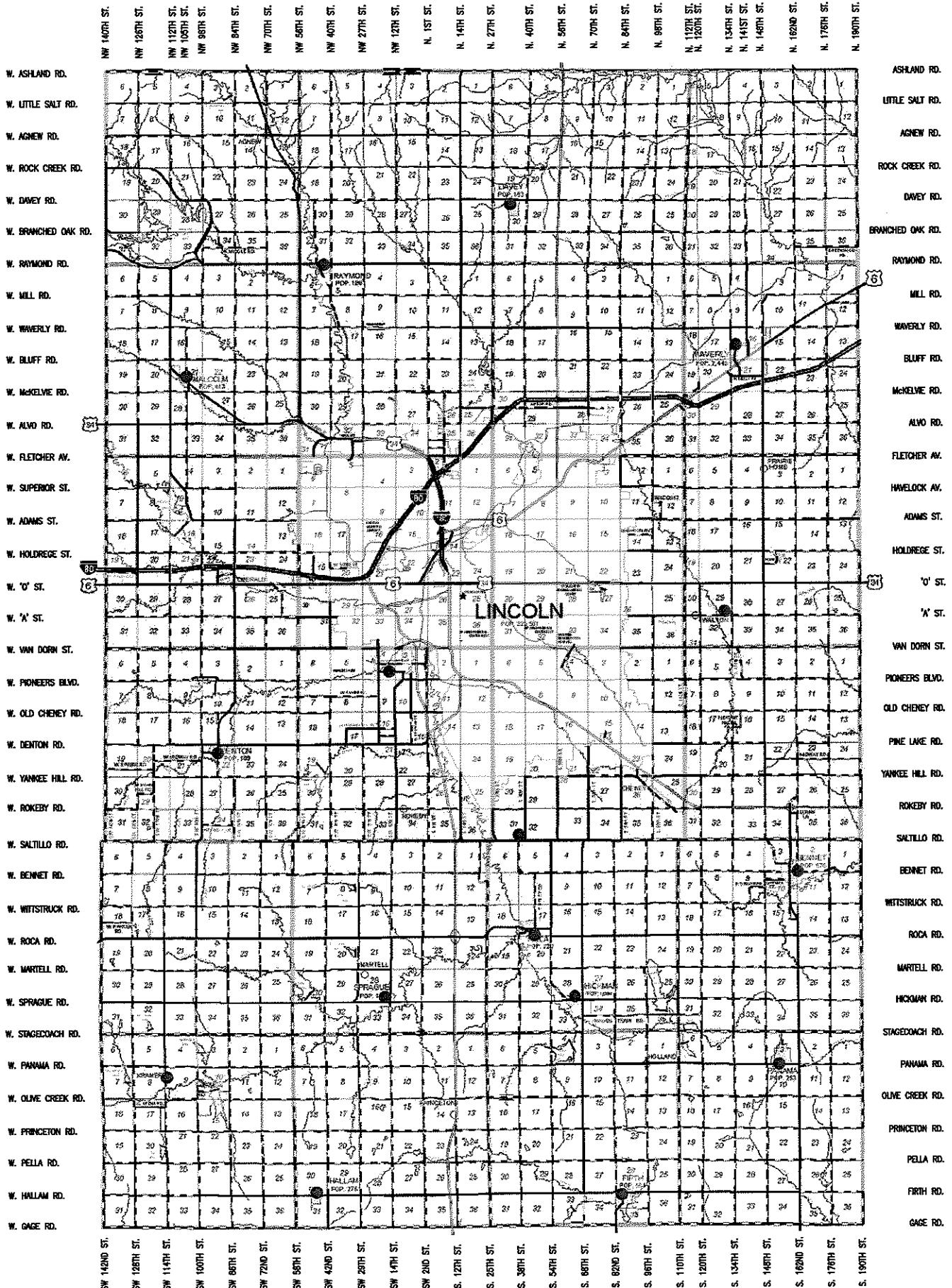

TYPICAL PAVEMENT MARKING PLAN

PROJECT NO. 17-05

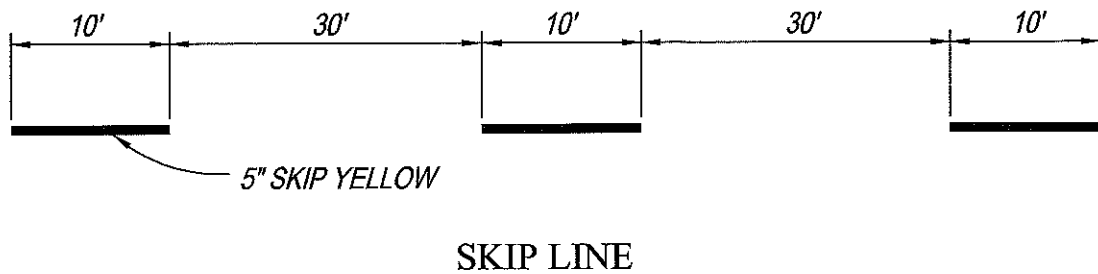
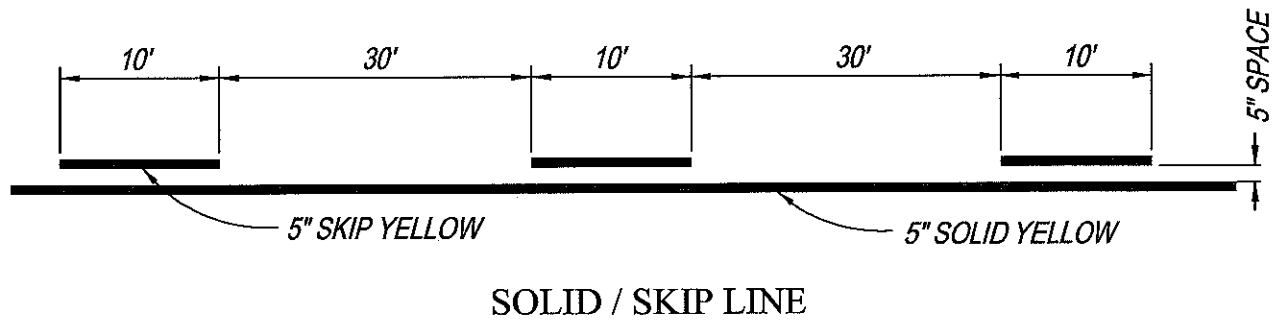
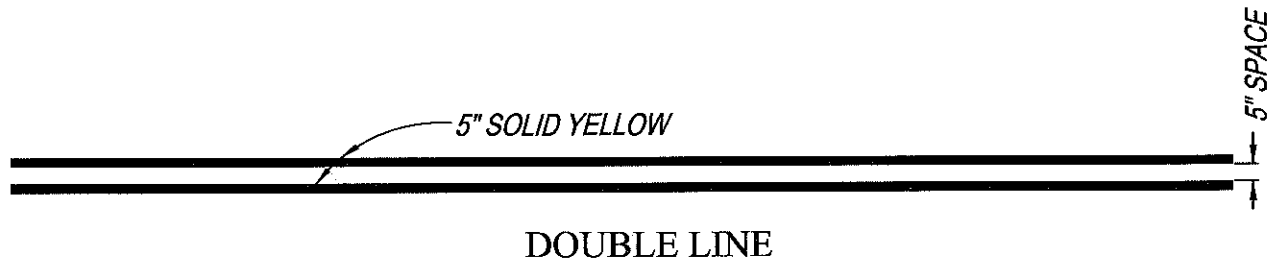
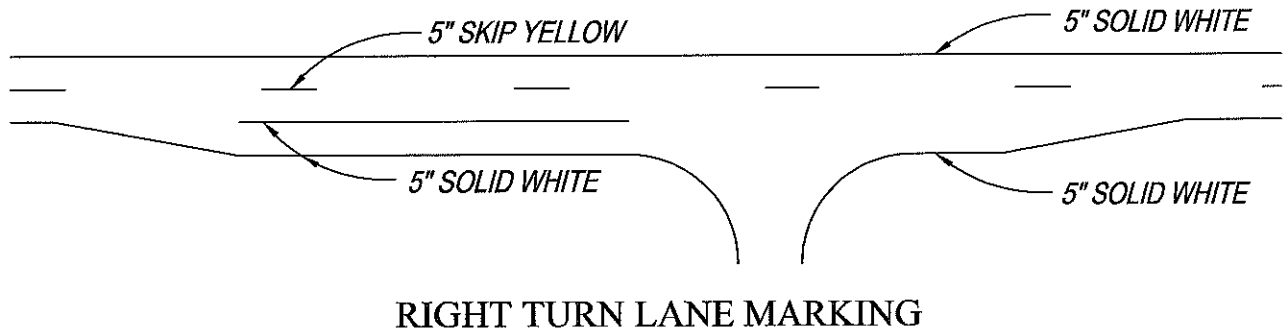

PERFORMANCE AND LABOR AND
MATERIAL PAYMENT BOND

KNOW ALL MEN BY THESE PRESENTS, that we, Straight-Line Striping Inc as principal, hereinafter referred to as "Contractor," and Universal Surety Company, a corporate surety company authorized to transact business in the State of Nebraska as surety, hereinafter referred to as "Surety," are held and firmly bound unto the County of Lancaster, Nebraska, hereinafter referred to as "County," in the penal sum of Two Hundred Fourteen Thousand Nine Hundred Ninety Dollars and 00/100 (\$214,990.00) lawful money of the United States for the payment of which sum, well and truly to be made, we bind ourselves and our heirs, executors, administrators, legal representatives, successors, and assigns jointly and severally, firmly by these presents.

THE CONDITION OF THIS OBLIGATION is such that whereas, the Contractor has entered into a certain contract with the County, dated _____, 2017, which contract hereby defined to include all contract documents (instructions to bidders, the accepted bid proposal, special and general conditions, specifications, and drawings) is by reference hereby made a part hereof and is hereinafter referred to as "Contract" for Project No. 17-05 -- Pavement Striping, Lancaster County, Nebraska.

NOW, THEREFORE, IF THE Contractor (1) shall in all particulars well, duly, and faithfully observe, perform, and abide by each and every covenant, condition, and part of the Contract according to the true intent and meaning in each case AND save harmless and defend the County from all suits, judgments, damages, costs, charges, and expenses which may accrue from failure to do so AND make good any and all guarantees which the Contract may require of the Contractor or of the subcontractors; and (2) shall duly pay for all labor, materials, equipment, tools, repairs on machinery, provisions, utilities, fuels, lubricants, and all other supplies or materials actually used or rented by the Contractor or by the subcontractors in performance of the Contract including all insurance premiums on insurance required by the Contract together with interest as provided by law - THEN this obligation shall be and become null and void; otherwise, it shall remain in full force and effect.

PROVIDED FURTHER, that the Surety for value received hereby stipulates and agrees that no change, extension of time, alteration, or addition to the terms of the Contract or to the work to be performed thereunder shall in any wise affect the Surety's obligation on this bond; and the Surety hereby waives notice of any change, extension of time, alteration, or addition to the terms of the Contract or to the work to be performed thereunder.

IN WITNESS WHEREOF, this bond is executed this _____ day of _____, 2017

AG
Witness
423 Ponderosa Dr. Grand Island NE
Address 68803

Bill Gosda
Witness
509 W. Koenig, Grand Island
Address Nebraska 68801

Straight-Line Striping Inc
Contractor
GLH President
President
423 Ponderosa Drive
Grand Island, NE 68803
Address

Universal Surety Company
Surety
CR
Attorney-in-fact Christopher Rosacker
PO Box 80468, Lincoln, NE 68501
Address

(Accompany this bond with Attorney-in-fact's authority from Surety, certified to include the above date of the bond.)

UNIVERSAL SURETY COMPANY

Lincoln, Nebraska

POWER OF ATTORNEY

KNOW ALL MEN BY THESE PRESENTS:

That the **UNIVERSAL SURETY COMPANY**, a corporation of the State of Nebraska having its principal office in the City of Lincoln, Nebraska, pursuant to the following Bylaw, which was adopted by the Board of Directors of the said Company on July 23, 1981, to wit:

"Article V-Section 6. RESIDENT OFFICERS AND ATTORNEYS-IN-FACT. The President or any Vice President, acting with any Secretary or Assistant Secretary, shall have the authority to appoint Resident Vice Presidents and Attorneys-In-Fact, with the power and authority to sign, execute, acknowledge and deliver on its behalf, as Surety: Any and all undertakings of suretyship and to affix thereto the corporate seal of the corporation. The President or any Vice President, acting with any Secretary or Assistant Secretary, shall also have the authority to remove and revoke the authority of any such appointee at any time."
does hereby make, constitute and appoint

Gary Rosacker or Jay C Huston or Deanne E. Gosda or Tami Towne or Christopher Rosacker
or Todd Price, Grand Island, Nebraska or Maureen Wagoner, Phillips, Nebraska

its true and lawful Attorney(s)-in-Fact, to make, execute, seal and deliver for and on its behalf, as Surety:
Any and all undertakings of suretyship

And the execution of such bonds or undertakings in pursuance of these presents, shall be as binding upon said Company, as fully and amply, to all intents and purposes, as if they had been duly executed and acknowledged by the regularly elected officers of the Company at its offices in Lincoln, Nebraska, in their own persons.

The following Resolution was adopted at the Regular Meeting of the Board of Directors of the **UNIVERSAL SURETY COMPANY**, held on July 23, 1981:

"RESOLVED, That the signatures of officers of the Company and the seal of the Company may be affixed by facsimile to any Power of Attorney executed in accordance with Article V-Section 6 of the Company Bylaws: and that any such Power of Attorney bearing such facsimile signatures, including the facsimile signature of a certifying Assistant Secretary and facsimile seal shall be valid and binding upon the Company with respect to any bond, undertaking or contract of suretyship to which it is attached."

All authority hereby conferred shall remain in full force and effect until terminated by the Company.

IN WITNESS WHEREOF, **UNIVERSAL SURETY COMPANY** has caused these presents to be signed by its President and its corporate seal to be hereunto affixed this 5th day of January, 20 17.

Carol J. Clark

UNIVERSAL SURETY COMPANY

Curt L. Hartter

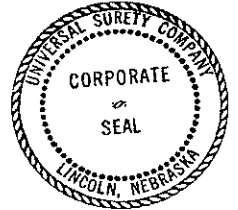

Secretary/Treasurer
By
State of Nebraska }
County of } ss. Lancaster

President

On this 5th day of January, 20 17, before me personally came Curtis L. Hartter, to me known, who being by me duly sworn, did depose and say that (s)he resides in the County of Lancaster, State of Nebraska; that (s)he is the President of the **UNIVERSAL SURETY COMPANY**, the corporation described in and which executed the above instrument; that (s)he knows the seal of the said corporation; that the seal affixed to the said instrument is such corporate seal; that it was so affixed by order of the Board of Directors of said corporation; that (s)he signed (his) (her) name by like order; and that Bylaw, Article V-Section 6, adopted by the Board of Directors of said Company, referred to in the preceding instrument, is now in force.

Tara N. Martin



My Commission Expires February 16, 2018.

Notary Public

I, Cheryl A. Brown, Assistant Secretary of **UNIVERSAL SURETY COMPANY**, do hereby certify that the above and foregoing is a true and correct copy of a Power of Attorney executed by said **UNIVERSAL SURETY COMPANY**, which is still in full force and effect.
Signed and sealed at the City of Lincoln, Nebraska this _____ day of _____, 20 17.

Cheryl A. Brown

Assistant Secretary



INLAND
INSURANCE COMPANY

UNIVERSAL
SURETY COMPANY

P.O. Box 80468 • Lincoln, Nebraska 68501-0468
PHONE • 1-800-755-2666
FAX • 402-435-3274

BID BOND

KNOW ALL MEN BY THESE PRESENTS: That we Straight-Line Striping, Inc.

as Principal, hereinafter called the principal, and Universal Surety Company
a corporation duly organized under the laws of the State of **NEBRASKA**, as Surety, hereinafter called the Surety, are held and firmly bound unto
County Treasurer of Lancaster County, Nebraska

as Obligee, hereinafter called the Obligee, in the sum of *****Five per cent of amount bid*****

(******5% of bid*****) DOLLARS,
lawful money of the United States of America, for the payment of which sum of money well and truly to be made, the said Principal and Surety bind themselves, their and each of their heirs, executors, administrators, successors and assigns, jointly and severally, firmly by these presents.

WHEREAS, the Principal has submitted a bid for: Pavement Striping
Project No. 17-05
Bid No. 17-049

NOW THEREFORE, if the Obligee shall accept the bid of the Principal and the Principal shall enter into a Contract with the Obligee in accordance with the terms of such bid, and give such bond or bonds as may be specified in the bidding or Contract Documents with good and sufficient surety for the faithful performance of such Contract and for the prompt payment of labor and material furnished in the prosecution thereof, or in the event of the failure of the Principal to enter such Contract and give such bond or bonds, if the Principal shall pay to the Obligee the difference not to exceed the penalty hereof between the amount specified in said bid and such larger amount for which the Obligee may in good faith contract with another party to perform the Work covered by said bid, then this obligation shall be null and void, otherwise to remain in full force and effect.

Signed, Sealed and Dated, this 22nd day of February, 20 17.

Ant Clasen
(Witness)

Doc Hosoda
(Witness)

Straight-Line Striping Inc.
Principal (Seal)

By: [Signature]
Name (Title)

Universal Surety Company
Surety (Seal)

By: [Signature]
Christopher Roascker (Attorney-in-Fact)

UNIVERSAL SURETY COMPANY

Lincoln, Nebraska

POWER OF ATTORNEY

KNOW ALL MEN BY THESE PRESENTS:

That the UNIVERSAL SURETY COMPANY, a corporation of the State of Nebraska having its principal office in the City of Lincoln, Nebraska, pursuant to the following Bylaw, which was adopted by the Board of Directors of the said Company on July 23, 1981, to wit:

"Article V-Section 6. RESIDENT OFFICERS AND ATTORNEYS-IN-FACT. The President or any Vice President, acting with any Secretary or Assistant Secretary, shall have the authority to appoint Resident Vice Presidents and Attorneys-in-Fact, with the power and authority to sign, execute, acknowledge and deliver on its behalf, as Surety: Any and all undertakings of suretyship and to affix thereto the corporate seal of the corporation. The President or any Vice President, acting with any Secretary or Assistant Secretary, shall also have the authority to remove and revoke the authority of any such appointee at any time."

Gary Rosacker or Jay C Huston or Deanne E. Gosda or Tami Towne or Christopher Rosacker or Todd Price, Grand Island, Nebraska or Maureen Wagoner, Phillips, Nebraska

its true and lawful Attorney(s)-in-Fact, to make, execute, seal and deliver for and on its behalf, as Surety:
Any and all undertakings of suretyship

And the execution of such bonds or undertakings in pursuance of these presents, shall be as binding upon said Company, as fully and amply, to all intents and purposes, as if they had been duly executed and acknowledged by the regularly elected officers of the Company at its offices in Lincoln, Nebraska, in their own persons.

The following Resolution was adopted at the Regular Meeting of the Board of Directors of the UNIVERSAL SURETY COMPANY, held on July 23, 1981:

"RESOLVED, That the signatures of officers of the Company and the seal of the Company may be affixed by facsimile to any Power of Attorney executed in accordance with Article V-Section 6 of the Company Bylaws: and that any such Power of Attorney bearing such facsimile signatures, including the facsimile signature of a certifying Assistant Secretary and facsimile seal shall be valid and binding upon the Company with respect to any bond, undertaking or contract of suretyship to which it is attached."

All authority hereby conferred shall remain in full force and effect until terminated by the Company.

IN WITNESS WHEREOF, UNIVERSAL SURETY COMPANY has caused these presents to be signed by its President and its corporate seal to be hereunto affixed this 5th day of January, 20 17

Carol J. Clark

UNIVERSAL SURETY COMPANY

Curt L. Hartter



Secretary/Treasurer By
State of Nebraska }
County of } ss. Lancaster

On this 5th day of January, 20 17, before me personally came Curtis L. Hartter, to me known, who being by me duly sworn, did depose and say that (s)he resides in the County of Lancaster, State of Nebraska; that (s)he is the President of the UNIVERSAL SURETY COMPANY, the corporation described in and which executed the above instrument; that (s)he knows the seal of the said corporation; that the seal affixed to the said instrument is such corporate seal; that it was so affixed by order of the Board of Directors of said corporation; that (s)he signed (his) (her) name by like order; and that Bylaw, Article V-Section 6, adopted by the Board of Directors of said Company, referred to in the preceding instrument, is now in force.

Tara N. Martin



My Commission Expires February 16, 2018.

Notary Public

I, Cheryl A. Brown, Assistant Secretary of UNIVERSAL SURETY COMPANY, do hereby certify that the above and foregoing is a true and correct copy of a Power of Attorney executed by said UNIVERSAL SURETY COMPANY, which is still in full force and effect.
Signed and sealed at the City of Lincoln, Nebraska this 22nd day of February, 20 17

Cheryl A. Brown

Assistant Secretary



CONTRACT AGREEMENT

RE: PURCHASING AGENT APPOINTMENT

The Contractor performing work for the County of Lancaster, Nebraska, will be issued a Purchasing Agent Appointment signed by the Purchasing Agent of the County. It is to be used by the Contractor and his subcontractors when purchasing tangible personal property to be actually incorporated into the contract work including materials incidental but necessary to the performance of the contract, provided that such materials are actually incorporated into the contract work. It does not apply to either (1) the purchase of materials to be used but not incorporated into the contract work including but not limited to form lumber, scaffold, etc.; or (2) the purchase or rental of machinery, equipment, or tools owned or leased by the Contractor or his subcontractors and used in performing the contract work.

Purchase qualifying as aforesaid shall be considered as being made by the County. The County shall be obligated to the vendor for the purchase price; but the Contractor or subcontractor, as the case may be, shall handle all payments therefore on behalf of the County. The vendor shall agree to make demand or claim for payment of the purchase price from the County by submitting an invoice to the Contractor or subcontractor. Title to all materials and supplies so qualifying shall vest in the County directly from the vendor; and regardless of the method of payment, title shall vest in the County as otherwise provided in the contract with the County. The Contractor or subcontractor shall not acquire title to any material incorporated into the project. All invoices shall bear the Contractor's or subcontractor's name as agent for the County.

The Contractor may reproduce copies of this Contract Agreement and of the original of the aforesaid Appointment and Certificate to furnish to his suppliers on each invoice or order. The Contractor shall enter the supplier's (the vendor's) name and address, the date, the invoice or order number, a description of the items, and the amount in the spaces provided and shall sign the certificate on the line provided for the "Purchaser's Agent."

The Contractor shall provide each subcontractor with a copy of this Contract Agreement; and of said Appointment and Certificate, the Contractor shall add the subcontractor's name and address in the places provided therefore. Each subcontractor is hereby given the authority to reproduce copies of the copy of said Appointment and Certificate thus provided him by the Contractor and to furnish the same to his (the subcontractor's) suppliers on each invoice or order, and the subcontractor shall complete and sign the same for his purchases in like manner as above set forth for the Contractor.



Nebraska Resale or Exempt Sale Certificate for Sales Tax Exemption

Form
13

Name and Mailing Address of Purchaser			Name and Mailing Address of Seller		
Name Lancaster County Engineering Department			Name Straight-Line Striping, Inc.		
Legal Name					
Street Address (Do not use PO Box) 444 Cherrycreek Rd., Bldg. "C"			Street or Other Mailing Address 423 Ponderosa Drive		
City Lincoln,	State NE	Zip Code 68528	City Grand Island	State NE	Zip Code 68803

Check Type of Certificate

- Single Purchase If single purchase is checked, enter the related invoice or purchase order number _____.
- Blanket If blanket is checked, this certificate is valid until revoked in writing by the purchaser.

I hereby certify that the purchase, lease, or rental by the above purchaser is exempt from the Nebraska sales tax for the following reason:

Check One Purchase for Resale (Complete Section A.) Exempt Purchase (Complete Section B.) Contractor (Complete Section C.)

Section A—Nebraska Resale Certificate

Description of Property or Service Purchased

I hereby certify that the purchase, lease, or rental of _____ from the seller listed above is exempt from the Nebraska sales tax as a purchase for resale, rental, or lease in the normal course of our business. The property or service will be resold either in the form or condition in which it was purchased, or as an ingredient or component part of other property or service to be resold.

I further certify that we are engaged in business as a: Wholesaler Retailer Manufacturer Lessor
of _____
Description of Product or Service Sold, Leased, or Rented

My Nebraska Sales Tax Permit Number is 01-_____.

If none, state the reason _____
or Foreign State Sales Tax Number _____ State _____.

Section B—Nebraska Exempt Sale Certificate

The basis for this exemption is exemption category 1 (insert appropriate number for the category of exemption described on the reverse side).

If exemption category 2 or 5 is claimed, enter the following information:

Description of Items Purchased

Intended Use of Items Purchased

If exemption category 3 or 4 is claimed, enter your Nebraska Exemption Certificate number. 05-_____
Do not enter your Federal Employer ID Number.

If exemption category 6 is claimed, the seller must enter the following information and sign this form below:

Description of Items Sold	Date of Seller's Original Purchase	Was tax paid when purchased by seller? <input type="checkbox"/> Yes <input type="checkbox"/> No	Was item depreciable? <input type="checkbox"/> Yes <input type="checkbox"/> No
---------------------------	------------------------------------	--	---

Section C—For Contractors Only

1. Purchase of building materials or fixtures.

As an Option 1 or Option 3 contractor, I hereby certify that the purchase of building materials and fixtures from the seller listed above are exempt from Nebraska sales tax. My Nebraska Sales or Use Tax Permit Number is: 01 .

2. Purchases made by an Option 2 contractor under a Purchasing Agent Appointment on behalf of _____
(exempt entity)

As an Option 2 contractor, I hereby certify that the purchase of building materials and fixtures from the seller listed above is exempt from Nebraska sales tax pursuant to the attached Purchasing Agent Appointment and Delegation of Authority for Sales and Use Tax, Form 17.

Any purchaser, agent, or other person who completes this certificate for any purchase which is not for resale, lease, or rental in the regular course of the purchaser's business, or is not otherwise exempted from sales and use taxes is subject to a penalty of \$100 or ten times the tax, whichever amount is larger, for each instance of presentation and misuse. With regard to a blanket certificate, this penalty applies to each purchase made during the period the blanket certificate is in effect. Under penalties of law, I declare that I am authorized to sign this certificate, and to the best of my knowledge and belief, it is correct and complete.

**sign
here** ▶

Authorized Signature

Purchasing Agent

Title

Date

Authorized Signature Name (please print)

Do not send this certificate to the Nebraska Department of Revenue. Keep it as part of your records.

Sellers cannot accept incomplete certificates.

revenue.nebraska.gov, 800-742-7474 (NE and IA), 402-471-5729

Instructions

Who May Issue a Resale Certificate. Form 13, Section A, is issued by persons or organizations making purchases of property or taxable services that will subsequently be resold in the purchaser's normal course of business. The property or services must be resold in the same form or condition as when purchased, or as an ingredient or component part of other property that will be resold.

Who May Issue an Exempt Sale Certificate. Form 13, Section B, may only be issued by governmental units and persons or organizations that are exempt from paying Nebraska sales and use tax. Nonprofit organizations that are exempt from paying sales and use tax are listed in the [Nebraska Sales Tax Exemption Chart](#).

Enter the appropriate number from the "Categories of Exemption" in the space provided that properly reflects the basis for your exemption. If category 2 through 6 is the basis for exemption, you must complete the information requested in Section B.

For additional information about proper issuance and use of this certificate, please review [Reg-1-013, Sale for Resale – Resale Certificate](#), and [Reg-1-014, Exempt Sale Certificate](#).

Contractors. To make tax-exempt purchases of building materials and fixtures, Option 1 or Option 3 contractors must complete Form 13, Section C, Part 1.

To make tax-exempt purchases of building materials and fixtures pursuant to a construction project for an exempt governmental unit or an exempt nonprofit organization, Option 2 contractors must complete Form 13, Section C, Part 2. The contractor must also attach a copy of a properly completed [Purchasing Agent Appointment and Delegation of Authority for Sales and Use Tax, Form 17](#), to the Form 13, and both documents must be given to the supplier when purchasing building materials. See the [contractor information guides](#) for additional information.

When and Where to Issue. The Form 13 must be given to the seller at the time of the purchase to document why sales tax does not apply to the purchase. The Form 13 must be kept with the seller's records for audit purposes (see [Reg-1-012, Exemptions](#)). Do not send Forms 13 to the Nebraska Department of Revenue.

Sales Tax Number. A purchaser who is engaged in business as a wholesaler or manufacturer is not required to provide an ID number when completing Section A. Out-of-state purchasers may provide their home state sales tax number. Section B does not require a Nebraska ID number when exemption category 1, 2, or 5 is indicated.

Fully Completed Resale or Exempt Sale Certificate.

For a resale certificate to be fully completed, it must include: (1) identification of the purchaser and seller, type of business engaged in by the purchaser, and reason for the exemption; (2) sales tax permit number; (3) signature of an authorized person; and (4) the date of issuance.

For an exempt sale certificate to be fully completed, it must include: (1) identification of purchaser and seller; (2) a statement that the certificate is for a single purchase or is a blanket certificate covering future sales; (3) a statement of the basis for exemption, including the type of activity engaged in by the purchaser; (4) signature of an authorized person; and (5) the date of issuance.

Penalties. Any purchaser who gives a Form 13 to a seller for any purchase which is other than for resale, lease, or rental in the normal course of the purchaser's business, or is not otherwise exempted from sales and use tax under the Nebraska Revenue Act, is subject to a penalty of \$100 or ten times the tax, whichever is greater, for each instance of presentation and misuse. In addition, any purchaser, or

their agent, who fraudulently signs a Form 13 may be found guilty of a Class IV misdemeanor.

Categories of Exemption

1. Governmental agencies identified in [Reg-1-012, Exemptions; Reg-1-072, United States Government and Federal Corporations; and Reg-1-093, Governmental Units](#). Governmental units are not assigned exemption numbers.

Sales to the United States government, its agencies, instrumentalities, and corporations wholly owned by the U.S. government are exempt from sales tax. However, sales to institutions chartered or created under federal authority, but which are not directly operated and controlled by the United States government for the benefit of the public, generally are taxable. For construction projects for federal agencies, see [Reg-1-017, Contractors](#).

Purchases by governmental units that are **not** exempt from Nebraska sales and use taxes include, but are not limited to: governmental units of other states; sanitary and improvement districts; rural water districts; railroad transportation safety districts; and county historical or agricultural societies.

2. Purchases when the intended use renders it exempt as stated in paragraph 012.02D of [Reg-1-012, Exemptions](#). See [Nebraska Sales Tax Exemption Chart](#). Complete the description of the item purchased and the intended use on the front of Form 13.

Beginning October 1, 2014, sales of repair and replacement parts for agricultural machinery and equipment used in commercial agriculture are exempt from sales and use taxes. When claiming this exemption, please enter "commercial agriculture" on the **Intended Use of Items Purchased** line.

3. Purchases made by organizations that have been issued a Nebraska Exempt Organization Certificate of Exemption. [Reg-1-090, Nonprofit Organizations; Reg-1-091, Religious Organizations; and Reg-1-092, Educational Institutions](#), identify these organizations. These organizations are issued a Nebraska state exemption ID number. This exemption number must be entered in Section B of Form 13.

Nonprofit **health care organizations** that hold a certificate of exemption are exempt for purchases of items for use at their facility, or portion of the facility, covered by the license issued under the Health Care Facility Licensure Act. Only specific types of health care facilities and activities are exempt. Purchases of items for use at facilities that are not covered under the license, or for any other activities that are not specifically exempt, are taxable.

4. Purchases of common or contract carrier motor vehicles, trailers, and semitrailers; accessories that physically become part of a common or contract carrier vehicle; and repair and replacement parts for these vehicles. The exemption number must be entered in Section B of the Form 13.
5. Purchases of manufacturing machinery and equipment made by a person engaged in the business of manufacturing, including repair and replacement parts or accessories, for use in manufacturing.
6. Occasional sales of used business or farm machinery or equipment productively used by the seller as a depreciable capital asset for more than one year in his or her business. The seller must have previously paid tax on the item being sold. The seller must complete, sign, and give the exemption certificate to the purchaser.

Purchasing Agent Appointment and Delegation of Authority for Sales and Use Tax

PURCHASING AGENT APPOINTMENT					
Name and Address of Prime Contractor			Name and Address of Governmental Unit or Exempt Organization		
Name Straight-Line Striping, Inc.			Name Lancaster County Engineering Department		
Street or Other Mailing Address 423 Ponderosa Drive			Street or Other Mailing Address 444 Cherrycreek Rd., Bldg. "C"		
City	State	Zip Code	City	State	Zip Code
Grand Island	NE	68803	Lincoln,	NE	68528
Name and Location of Project			Appointment Information		
Name Pavement Striping			Effective Date (see Instructions)		
Street or Other Mailing Address			Expiration Date		
City	State	Zip Code	Nebraska Exemption Number (Exempt Organizations Only)		
Lancaster County, NE			N/A (Gov't)		
Identify Project Bid No. 17-049 - Project No. 17-05					

The undersigned governmental unit or exempt organization appoints the above-named contractor and the contractor's delegated subcontractors as its agent to purchase and pay for building materials that will be annexed to real estate by them into the tax exempt construction project stated above.

**sign
here** ▶

Authorized Signature of Governmental Unit or Exempt Organization

Title

Date

DELEGATION OF PRIME CONTRACTOR'S AUTHORITY					
Name and Address of Subcontractor			Delegation Information		
Name			Effective Date		
Street or Other Mailing Address			Expiration Date		
City	State	Zip Code	Portion of Project		

The undersigned prime contractor hereby delegates authority to act as the purchasing agent of the named governmental unit or exempt organization to the above-named subcontractor.

**sign
here** ▶

Signature of Prime Contractor or Authorized Representative

Title

Date

INSTRUCTIONS

WHO MUST FILE. Any governmental unit or organization that is **exempt** from sales and use tax may appoint as its agent a prime contractor to purchase building materials and/or fixtures that will be annexed to property that belongs to or will belong to the governmental unit or exempt organization pursuant to a construction contract with the governmental unit or exempt organization. The appointment of the prime contractor as its agent is completed by issuing a Purchasing Agent Appointment and Delegation of Authority for Sales and Use Tax, Form 17, to the prime contractor. The Form 17 is required to be given to the contractor **BEFORE** he or she annexes building materials. The governmental unit or exempt organization must identify the project (e.g., east wing, chapel construction, or new school auditorium). Most

nonprofit organizations are **NOT** exempt from sales tax in Nebraska. In addition, not all governmental units are exempt from Nebraska sales tax. Refer to Contractor Information on our Web site for additional information on exempt entities. A contractor can confirm the exempt status of a governmental unit or exempt organization by contacting the Nebraska Department of Revenue.

The exemption from the payment of the Nebraska and local option sales and use taxes only applies if the governmental unit or exempt organization directly, or through its contractor, pays for the building materials. **IMPORTANT NOTE:** When an organization that requires licensure in order to be exempt (i.e., nonprofit hospitals), but is not licensed at the time of the construction project, the exempt organization **CANNOT**

issue either a purchasing agent appointment or an exemption certificate. If the exempt organization becomes licensed upon completion of the project, it may apply for a refund of the tax paid or collected by the contractors.

WHEN TO FILE. A prime contractor engaging in a construction project with a governmental unit or exempt organization must receive a properly completed and signed Form 17 **BEFORE** any building materials are annexed. If Form 17 is not issued, the contractor must pay the sales and use taxes and the governmental unit or exempt organization may obtain a refund of the taxes paid by the contractor.

WHERE TO FILE. A copy of the completed form should be retained by the governmental unit or exempt organization issuing the Form 17. The original is to be retained by the prime contractor. Copies of this form must be made by the prime contractor for delegation purposes to any subcontractors working on the project identified on this form.

APPOINTMENT INFORMATION. Enter the dates the purchasing agent appointment will become effective and when it will expire. This appointment will not allow any purchases without payment of the tax by the prime contractor or subcontractor before the effective date or after the expiration date. The dates the delegation becomes effective and the expiration dates must be completed. The phrase "upon completion" or similar phrase is not acceptable as an expiration date. The governmental unit or exempt organization may need to issue another Form 17 if the project is not completed within the prior "effective" and "expiration" dates. Exempt organizations must enter their Nebraska Sales and Use Tax Exemption number.

DELEGATION OF PRIME CONTRACTOR'S AUTHORITY. The prime contractor may delegate his or her authority to act as the purchasing agent of the governmental unit or exempt organization to a subcontractor. The prime contractor must complete his or her copy of Form 17 for each subcontractor who is delegated authority to act as a purchasing agent. Reproductions of this delegation must be provided to the subcontractor, who must retain a copy for his or her records, and to the governmental unit or exempt organization.

Enter the dates the delegation of the subcontractor will become effective, when it will expire, and the portion of the project delegated. This delegation will not allow any purchases without payment of the tax by the subcontractor before the delegation date or after the expiration date. Any further delegation from a subcontractor to additional subcontractors must be delegated by providing a copy of the Form 17 that they received from the prime contractor and attaching it to a separate Form 17 with any further delegation to other subcontractors. The purchasing agent appointment is limited to the contractor's purchase of building materials and/or fixtures for the specific project and is only valid during the appointment dates shown on the Form 17.

EXEMPT SALE CERTIFICATE. A prime contractor who has been appointed to act as a purchasing agent by a governmental unit or exempt organization, and who hires a subcontractor operating as an Option 1 contractor, must provide to that subcontractor a completed copy of Form 17 and a Nebraska Resale or Exempt Sale Certificate, Form 13, with Section C,

Part 2, completed. The subcontractor will retain these forms in his or her records, and will not charge the contractor sales tax on any portion of the invoice involving the annexation of materials to the specific project identified on the Form 17. If these forms are not provided to the subcontractor operating under Option 1, the subcontractor must collect and remit sales tax on the charge for the separately stated building materials portion of the invoice. If the Option 1 subcontractor does not separately state the charge for the building materials from contractor labor, then the entire charge is taxable to the prime contractor.

Contractors operating under Option 2 (maintaining a tax-paid inventory) who have been issued a Form 17 from a governmental unit or an exempt organization, must furnish each vendor a copy of the Form 17 and a Form 13, completing Section C, Part 2, when purchasing building materials that will be annexed to real estate. Forms 13 and 17 must be retained with the vendor's and contractor's records for audit purposes. A contractor or subcontractor may reproduce copies of these documents which will be furnished to the vendors for each invoice or order made by them.

Invoices from vendors for the purchase of building materials by the contractor as purchasing agent, or the authorized subcontractor, must clearly identify that such purchase is for the specific Form 17 project.

CREDIT/REFUND OF SALES AND USE TAX. A contractor or subcontractor who has been appointed as a purchasing agent before any materials are annexed, may withdraw sales or use tax-paid materials from inventory that will be annexed to real estate or used to repair property annexed to real estate and receive a credit for the sales or use tax amount previously paid on those materials.

The contractor or subcontractor may take a credit either against his or her current tax liability, or file a Claim for Overpayment of Sales and Use Tax, Form 7, and receive a refund of the sales or use tax paid on those materials.

TOOLS, EQUIPMENT, AND SUPPLIES. The purchase, rental, or lease of tools, supplies, or equipment (i.e., scaffolding, barricades, machinery, etc.) by a contractor for use in the completion of an exempt project CANNOT be purchased tax free, even if the contractor has been issued a Form 17. These items do not become annexed to the real estate.

OPTION 1 CONTRACTOR ONLY. If an Option 1 contractor is the **only** contractor involved in performing work for a governmental unit or exempt organization, a Form 17 is NOT required. The Option 1 contractor must only obtain a Form 13, Section B, from the exempt project owner.

PENALTY. Any person who signs this document with the intent to evade payment of tax is liable for the sales and use tax, interest, and penalty, and may be found guilty of a misdemeanor.

AUTHORIZED SIGNATURE. The purchasing agent appointment must be signed by an officer of the exempt organization or proper government official. The delegation of prime contractor's authority must be signed by the owner, partner, corporate officer, or other individual authorized to sign by a power of attorney on file with the Nebraska Department of Revenue.

Tax Assessment Form
Certified Statement Pursuant to Neb. Rev. Stat. § 77-1323

§ 77-1323 Every person, partnership, limited liability company, association, or corporation furnishing labor or material in the repair, alteration, improvement, erection, or construction of any public improvement shall furnish a certified statement to be attached to the contract that all equipment to be used on the project, except that acquired since the assessment date, has been assessed for taxation for the current year, giving the county where assessed.

Pursuant to Neb. Rev. Stat. § 77-1323, I, Casey Clausen, do hereby certify that all equipment to be used on County Project No. 17-05; Pavement Striping, except that equipment acquired since the assessment date, has been assessed for taxation for the current year, in Hall County, Nebraska.

DATED this 22 day of March, 2017.

By: [Signature]
Title: President

STATE OF Nebraska)
COUNTY OF Hall) ss.

On March 22, 2017 before me, the undersigned Notary Public duly commissioned for and qualified in said County, personally came Casey Clausen, to me known to be the identical person, whose name is affixed to the foregoing instrument and acknowledged the execution thereof to be his voluntary act and deed.

Witness my hand and notarial seal the day and year last above written.

Deanne E. Gosda
Notary Public
5-4-19
My Commission Expires

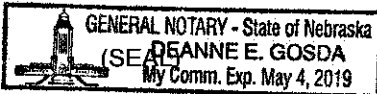

LANCASTER COUNTY
EMPLOYER CLASSIFICATION ACT INSTRUCTIONS

WHEREAS, there is concern over the inappropriate competitive advantages in the public bidding process for local publicly funded construction and delivery service contracts resulting from the misclassification of individuals performing construction labor services as "independent contractors" rather than "employees"; such "independent contractors" are commonly referred to as "1099 workers" due to the IRS form they receive rather than a W-4 which an employee receives;

WHEREAS, this mis-classification of such individuals as "independent contractors" rather than as "employees" eliminates any obligation to pay these individuals legally required minimum or overtime wages, to provide legally required workers' compensation insurance, to make unemployment insurance payments, to pay legally required employment and payroll taxes, and to provide any other health, pension, or benefit such individuals would typically receive if properly classified as employees;

WHEREAS, this mis-classification of individuals performing construction labor services for the contractor as "independent contractors" rather than "employees" is a violation of federal and state law, but is difficult to enforce once public construction or delivery service contracts have been bid, awarded, and entered into;

WHEREAS, the use of public funds to compensate contractors who unlawfully avoid their obligation to pay legally required minimum or overtime wages, to provide legally required workers' compensation insurance, to make unemployment insurance payments, to pay legally required employment and payroll taxes, and to provide any other health, pension, or benefit is not in the public interest; and

WHEREAS, the Employee Classification Act, *Neb. Rev. Stat. §§ 48-2901 to 48-2912* (effective July 15, 2010) provides that any contract entered into between a political subdivision and a contractor shall require that each contractor who performs construction or delivery service pursuant to the contract submit to the political subdivision an affidavit attesting that (1) each individual performing services for such contractor is properly classified under the Employee Classification Act, (2) such contractor has completed a federal I-9 immigration form and has such form on file for each employee performing service, (3) such contractor has complied with *Neb. Rev. Stat. § 4-114* requirements that the contractor register and use a federal immigration employment verification system to determine the work eligibility status of new employees physically performing services in the State of Nebraska, (4) such contractor has no reasonable basis to believe that any individual performing services for such contractor is an undocumented worker, and (5) as of the time of the contract, such contractor is not barred from contracting with the state or any political subdivision pursuant to *§ 48-2912 of the Employee Classification Act*.

NOW, THEREFORE, Lancaster County adopts the following policy as to the bid and award of contracts to contractors for construction and delivery services with Lancaster County;

The Purchasing Agent shall immediately include in the County's notice to bidders for construction contracts that all contractors submitting bids in response to the notice shall affirmatively certify to the Purchasing Agent that all individuals hired to perform construction or delivery labor services for the contractor under the contract shall be properly classified as employees and not as independent contractors if the individual does not meet the requirements of an independent contractor under federal and state law (including the requirements of the State of Nebraska Employee Classification Act), and that the contractor will comply with all legal obligations with respect to these employees (including, but not limited to , minimum and overtime pay, workers' compensation, unemployment compensation, and payment of federal and state payroll taxes). The notice to bidders shall further provide that contractors may use affidavits required pursuant to the Employee Classification Act for this purpose, but that a failure to make the affirmative certification to the Purchasing Agent shall render the bidder ineligible for award of the contract.

The Purchasing Agent shall immediately include the following provisions in contracts for construction or delivery services:

(1) Contractor agrees that each individual performing services for the contractor shall be properly classified as an employee and not as an independent contractor if the individual does not meet the requirements of an independent contractor under the State of Nebraska's Employee Classification Act and that contractor shall comply with all legal obligations with respect to the employee (including, but not limited to, minimum and overtime pay, workers' compensation, unemployment compensation, and payment of federal and state payroll taxes).

(2) Contractor understands and agrees that failure to classify each individual hired to perform services under the contract as an employee rather than as an independent contractor if the individual does not meet the requirements of an independent contractor under the State of Nebraska's Employee Classification Act and/or failure to comply with legal obligations with respect to the employee (including, but not limited to, minimum and overtime pay, workers' compensation, unemployment compensation, and payment of federal and state payroll taxes) shall be considered a breach of the contract and is a ground for rescission of the Contract by the County.

(3) Contractor additionally agrees to include the following provision in each subcontract entered into with a subcontractor as part of the contractor's contract with the County.

(a) Subcontractor agrees that each individual performing services for the subcontractor shall be properly classified as an employee and not as an independent contractor if the individual does not meet the requirements of an independent contractor under the State of Nebraska's Employee Classification Act and that subcontractor shall comply with all legal obligations with respect to the employee (including, but not limited to, minimum and overtime pay, workers' compensation, unemployment compensation, and payment of federal and state payroll taxes).

(b) Subcontractor understands and agrees that subcontractor's failure to properly classify individuals hired to perform services under the subcontract as employees and not as independent contractors if the individual does not meet the requirements of an independent contract under the State of Nebraska's Employee Classification Act and/or failure to comply with legal obligation with respect to the employee (including, but not limited to, minimum and overtime pay, workers' compensation, unemployment compensation, and payment of federal and state payroll taxes) shall be considered a breach of the contract and is a ground for rescission of the subcontract with the contractor.

(4) Contractor agrees that if subcontractor fails to or is suspected of failing to properly classify each individual hired pursuant to the subcontract as an employee and not as an independent contractor if the individual does not meet the requirements of an independent contractor under the State of Nebraska's Employee Classification Act and/or fails to comply with legal obligations with respect to the subcontractor's employees, the contractor shall take appropriate corrective action including, but not limited to, reporting the suspected violation of the State of Nebraska Employee Classification Act to the Nebraska Department of Labor or rescission of the subcontract by the contractor. Written notification of the corrective action shall be submitted to the Lincoln-Lancaster County Purchasing Department. Contractor understands and agrees that contractor's failure to take appropriate corrective action shall be considered a breach of the contractor's contract with the County and is a ground for rescission of the contract by the County.

(5) The County shall notify the Nebraska Department of Labor of any contractor or subcontractor it has determined is in breach of contract due to the terms of this order.

(6) Any contractor or subcontractor who shall have been determined by the Nebraska Department of Labor to have knowingly provided a false affidavit to the County under the State of Nebraska's Employee Classification Act shall be referred to the Purchasing Agent of the County who shall determine whether to declare such contractor or subcontractor an irresponsible bidder who shall be disqualified from receiving any business from the County for a stated period of time.

(7) This policy does not prohibit a contractor or subcontractor from hiring individuals to perform construction labor services as independent contractors, provided that the contractor's or subcontractor's use of such individuals as an independent contractor complies with the criteria found in subdivision 5 of *Neb. Rev. Stat. § 48-604* and is otherwise valid under federal and state law and is not intended to circumvent lawful obligations under federal and state law or county contractual requirements.

EMPLOYEE CLASSIFICATION ACT AFFIDAVIT

For the purpose of complying with THE NEBRASKA EMPLOYEE CLASSIFICATION ACT, Nebraska Revised Statutes 48-2901 to 48-2912,

I, Straight-Line Striping, Inc., herein below known as the Contractor, state under oath and swear as follows:

1. Each individual performing services for the Contractor is properly classified under the Employee Classification Act.
2. The Contractor has completed a federal I-9 immigration form and has such form on file for each employee performing services.
3. The Contractor has complied with *Neb. Rev. Stat. 4-114*.
4. The Contractor has no reasonable basis to believe that any individual performing services for the Contractor is an undocumented worker.
5. The Contractor is not barred from contracting with state or any political subdivision pursuant to *Neb. Rev. Stat. 48-2912* of this Act.
6. As the Contractor, I understand that pursuant to the Employee Classification Act a violation of the Act by a contractor is grounds for rescission of the contract by Lancaster County. I understand that pursuant to the Act any contractor who knowingly provides a false affidavit may be subject to criminal penalties and upon a second or subsequent violation shall be barred from contracting with Lancaster County for a period of three years after the date of discovery of the falsehood.

I hereby affirm and swear that the statements and information provided on this affidavit are true, complete and accurate. The undersigned person does hereby agree and represent that he or she is legally capable to sign this affidavit and to lawfully bind the Contractor to this affidavit.

PRINT NAME: Casey Jerome Clausen
 (First, Middle, Last)

SIGNATURE: [Handwritten Signature]

TITLE: President

State of Nebraska)
)ss.
 County of Hall)

This affidavit was signed and sworn to before me, the undersigned Notary Public, on this
22nd day of March, 2017.

Deanne E. Gosda
 Notary Public

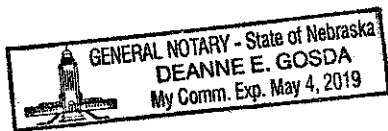

THIS ENDORSEMENT CHANGES THE POLICY. PLEASE READ IT CAREFULLY.

**ADDITIONAL INSURED – OWNERS, LESSEES OR
CONTRACTORS – SCHEDULED PERSON OR
ORGANIZATION**

This endorsement modifies insurance provided under the following:

COMMERCIAL GENERAL LIABILITY COVERAGE PART

SCHEDULE

Name of Person or Organization:

Lancaster County

(If no entry appears above, information required to complete this endorsement will be shown in the Declarations as applicable to this endorsement.)

A. Section II – Who Is An Insured is amended to include as an insured the person or organization shown in the Schedule, but only with respect to liability arising out of your ongoing operations performed for that insured.

B. With respect to the insurance afforded to these additional insureds, the following exclusion is added:

2. Exclusions

This insurance does not apply to "bodily injury" or "property damage" occurring after:

- (1) All work, including materials, parts or equipment furnished in connection with such work, on the project (other than service, maintenance or repairs) to be performed by or on behalf of the additional insured(s) at the site of the covered operations has been completed; or
- (2) That portion of "your work" out of which the injury or damage arises has been put to its intended use by any person or organization other than another contractor or subcontractor engaged in performing operations for a principal as a part of the same project.

WAIVER OF OUR RIGHT TO RECOVER FROM OTHERS ENDORSEMENT

We have the right to recover our payments from anyone liable for an injury covered by this policy. We will not enforce our right against the person or organization named in the Schedule. (This agreement applies only to the extent that you perform work under a written contract that requires you to obtain this agreement from us.)

This agreement shall not operate directly or indirectly to benefit anyone not named in the Schedule.

Schedule

Lancaster County

This endorsement changes the policy to which it is attached and is effective on the date issued unless otherwise stated.

(The information below is required only when this endorsement is issued subsequent to preparation of the policy.)

Endorsement
Insured Straight-Line Striping Inc

Effective Policy No.
5H59120

Endorsement No. 1
Premium

Insurance Company
EMC Insurance Company

Countersigned by

Dee Bordo

WC 00 03 13
(Ed. 4-84)

CITY OF LINCOLN/LANCASTER COUNTY
PURCHASING DEPARTMENT
NOTIFICATION FOR ADVERTISED BID

PAVEMENT STRIPING
County Project No. 17-05
Bid No. 17-049

You are invited to submit a bid through the City of Lincoln/Lancaster County Purchasing website on an advertised bid for Pavement Striping, Project No. 17-05 - Lancaster County Bid No. 17-049. Bids will be accepted on or before 12:00 noon, Wednesday, February 22, 2017.

PLEASE NOTE: ONLY BIDS SUBMITTED ELECTRONICALLY WILL BE ACCEPTED.

The plans and specs are available to Contractors via the E-Bid process by downloading the documents from the City of Lincoln/Lancaster County website.

Registration is required on the City of Lincoln/Lancaster County Purchasing website in order to submit a bid. Once registered in the E-Bid system, you will receive two e-mail notifications, the first one acknowledges registration, the second, registration approval. Upon e-mail notification of registration approval, you may print the specs and plans and also submit your electronic bid/proposal on the City/County Purchasing E-Bid system. A PC is available in the Purchasing Office for use by your company if you do not have computer access. Please call (402) 441-8103 to make an appointment.

Once you are registered you will automatically receive an e-mail notification of any and all bids for the City of Lincoln and Lancaster County for the services you provide. You will also be able to review all bid prices via the e-bid system as soon as they are unsealed on the designated day and time.

Questions concerning the registration and bid/proposal process may
be directed to City/County Purchasing
(402) 441-8309 or (402) 441-8103 or rwalla@lincoln.ne.gov

TO REGISTER, GO TO:
lincoln.ne.gov
TYPE "ebid" IN SEARCH BOX
CLICK "SUPPLIER REGISTRATION"
ENTER INFORMATION AS REQUIRED - TAKES ONLY 5-7 MINUTES!

Thank you for registering, we look forward to doing business with you.

LANCASTER COUNTY, NEBRASKA

PAVEMENT STRIPING

PROJECT NO. 17-05

TABLE OF CONTENTS

INSTRUCTIONS TO BIDDERS

SUPPLEMENTAL INSTRUCTIONS TO BIDDERS

MAP

PROPOSAL

CONTRACTOR WORK RESUME FORM

SPECIAL PROVISIONS

CONTRACT AGREEMENT

PERFORMANCE AND LABOR AND MATERIAL PAYMENT BOND

PURCHASING AGENT APPOINTMENT

NEBRASKA RESALE OR EXEMPT SALES CERTIFICATE

TAX ASSESSMENT FORM

EMPLOYER CLASSIFICATION ACT INSTRUCTIONS

EMPLOYEE CLASSIFICATION ACT AFFIDAVIT

INSURANCE CLAUSE AND CERTIFICATE