

Lancaster County, Nebraska

REQUISITION FORM

Name of person requisitioning:		Ron Bohaty	Requisition Number (Optional):			
Delivery Location:		444 Cherrycreek Rd, Lincoln, NE 68528, Bldg B	Date Prepared:		3/3/17	
Suggested Vendor:		Falcon Equipment Holdings LLC	Date Requested:		3/3/17	
Fund:	022	120 Waldo Ave	For Budget Year:		2017	
Agency:	703	Midland MI. 48642-5965	Purchase Order Number (assigned by Purchasing):			
ORG.	OBJ CODE	DESCRIPTION	QTY	UNIT	UNIT PRICE	AMOUNT
703	67425	Asphalt recycling, Hot Box Patching Trailer				
		Falcon 6 Ton Recycler (two hopper burners)				
		Dump Box mounted on 20,000 lbs trailer	1	Base	Unit	\$48,467.00
		Propane torch w/mounting bracket for 20lb cylinder	1	Unit		\$406.00
		Hose reel for tack spray system	1	Unit		\$944.00
		Spray system – 5.5hp motor, Viking hl32 pump, 10gal flush tank and spray wand with ½" hoses	1	Unit		\$4,519.00
		30 gallon heated tack tank, gravity feed	1	Unit		\$3,660.00
		Pricing is from State of Nebraska contract # 14684 (OC)				
		See attached quote and contract				
		Delivery to the above address	1			\$922.00
			TOTAL			\$58,988.00

Do Not exceed 1 vendor per requisition

Route completed requisition to:
 City/County Purchasing Division
 440 So. 8th Street, SW Wing, Suite 200
 Lincoln, NE 68508

The undersigned hereby certifies that the above requisitioned material and/or service is included in the current appropriation

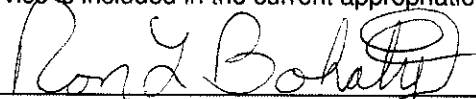
 Office/Agency/or Department Head

March 3, 2017
 Date



Price Quote

Requested by: Lancaster County
 Ron Bohaty
 Falcon NJPA Contract #113012-FRM
 NE

Quote Date	Quote Good Through	Freight Terms
2017-03-01	2017-03-31	FOB Midland, MI

Qty	Item No	Description	Price
1	5D35435	<p>Falcon 6 Ton Recycler (Two Hopper Burners)</p> <p>12-Volt Battery Triple Wall Construction and Fully Insulated Automatic Temperature Control Dual Burner Recycling Package (2nd Burner, 2nd Heat Duct and 24-Hour Timer Included) VIP Technology - Voltage Indicator and Protector Controller Automatically Prevents Burner(s) from Operating Below Burner Manufacturer's Required Voltage One-Piece, Seamless Ceramic Combustion Chamber Independently Certified 92% Fuel Efficiency Two 10k lb. Torsion Axles Trailer Frame - 2" x 8" x 1/4" Tubular Steel Diamond Tread Plate Hopper Access Platform Electric Brakes w/ Safety Breakaway Painted Falcon Red / 7-Pin RV Trailer Plug / Conspicuity Tape 2-Year Machine Warranty and Lifetime Frame Warranty</p> <p>Standard Options:</p> <p>Bi-Fold Manual Upper Loading Doors Dump Box (12-Volt Electric Over Hydraulic On-Board Pump) Dual Burner Recycling Package with 24-Hour Timer Single Frame Extension 17.5" Tires with 8-Bolt Wheels Battery Charger Package Release Agent Sprayer Bracket (8" x 8" ID) LED Tail Light Upgrade - Two Red Stop/Tail/Turn Lights and One Amber Strobe Per Side Night Work Lights - LED Strobe Warning Light - LED Shovel Holder - 3-Positions</p>	\$48,467

Qty	Item No	Description	Price
		Optional Features: Propane Torch with Mounting Bracket for 20 lb Propane Cylinder (Cylinder not Included) Hose Reel for Spray System Spray System - 5.5 HP Motor, Viking HL32 Pump, 10-Gallon Flush Tank and Spray Wand with 1/2" Hoses 30-Gallon Heated Tack Tank - Gravity Feed Two-Year Machine Warranty and Lifetime Frame Warranty	\$406 \$944 \$4,519 \$3,660 Included
		Total Equipment Price (Excluding Tax and Freight) Estimated Freight	\$57,996 \$992
		Total Price (Excluding Tax)	\$58,988

STATE OF NEBRASKA CONTRACT AWARD

State Purchasing Bureau
1526 K Street, Suite 130
Lincoln, Nebraska 68508

Telephone: (402) 471-6500
Fax: (402) 471-2089

CONTRACT NUMBER
14684 OC

PAGE 1 of 1		ORDER DATE 11/28/16	
BUSINESS UNIT 9000		BUYER RITA SCHWABE (AS)	
VENDOR NUMBER: 2358757			
VENDOR ADDRESS: FALCON EQUIPMENT HOLDINGS LLC DBA FALCON ROAD MAINTENANCE EQUIPMENT LLC 120 WALDO AVE MIDLAND MI 48642-5965			

AN AWARD HAS BEEN MADE TO THE CONTRACTOR NAMED ABOVE FOR THE FURNISHING OF MATERIALS AND/OR SERVICES AS LISTED BELOW FOR THE PERIOD:

NOVEMBER 28, 2016 THROUGH FEBRUARY 20, 2017

NO ACTION ON THE PART OF THE CONTRACTOR NEEDS TO BE TAKEN AT THIS TIME. ORDERS FOR THE MATERIALS AND/OR SERVICES WILL BE MADE AS NEEDED BY THE VARIOUS AGENCIES OF THE STATE.

THIS CONTRACT IS NOT AN EXCLUSIVE CONTRACT TO FURNISH THE MATERIALS AND/OR SERVICES SHOWN BELOW, AND DOES NOT PRECLUDE THE PURCHASE OF SIMILAR MATERIALS AND/OR SERVICES FROM OTHER SOURCES.

THE STATE RESERVES THE RIGHT TO EXTEND THE PERIOD OF THIS CONTRACT BEYOND THE TERMINATION DATE WHEN MUTUALLY AGREEABLE TO THE CONTRACTOR AND THE STATE OF NEBRASKA.

Originally awarded from National Joint Powers Alliance @ (NJPA) Contract 113012-FRM

Contract to supply and deliver Asphalt Recycling, Hot Boxes, and Patching Equipment, through a prime vendor program to State of Nebraska agencies for the period November 28, 2016 through February 20, 2017, with the option to renew for one (1) additional one (1) year period, per the terms, conditions, and specification of the "Request for Proposal".

Payment: 45 days

(For the File - All requests for proposal (RFP) evaluation, etc., are retained by National Joint Power Alliance@ (NJPA). This RFP and Contract are bid and awarded by the on behalf of NJPA and its current and potential member agencies to include all government, higher education, K-12 education, nonprofit, tribal government, and other public agencies located nationally within all fifty (50) states and Canada, and internationally, of which, Nebraska is a member).

(For the File: The NJPA Master Price Agreement contract period was effective March 6, 2014. The Participating Addendum for Nebraska Became effective November 28, 2016.)

Vendor Contact: Ric Simon
Phone: 248-207-1783
Email: ric@falconrme.com

Line	Description	Estimated Quantity	Unit of Measure	Unit Price
1	ASHPALT RECYCLING, HOT BOXES, AND PATCHING EQUIPMENT	50,000.0000	\$	1.0000

Rita Schwabe 12/5/16
1526 K Street, Suite 130
BUYER
12/17/16
MATERIEL ADMINISTRATOR

NATIONAL JOINT POWERS ALLIANCE

PARTICIPATING ADDENDUM

(Hereinafter "Addendum")

For

Asphalt Recycling, Hot Box and Patching Equipment

Between

The State of Nebraska ("Participating State/Entity"),

and

Falcon Road Maintenance Equipment, LLC. (Contractor)

National Joint Powers Alliance® (NJPA) Contract #113012-FRM

State of Nebraska Contract: 14684 OC

Page 1 of 8

1. SCOPE

This addendum covers the purchase of Asphalt Recycling, Hot Box, and Patching Equipment for use by state agencies and other entities located in the Participating **State/Entity** authorized by that state's statutes to utilize **state/entity** contracts with the prior approval of the state's chief procurement official.

2. PARTICIPATING STATE MODIFICATIONS OR ADDITIONS TO MASTER AGREEMENT

a. PRICES

Prices shall be net, including transportation and delivery charges fully prepaid by the Contractor, F. O. B. Destination Freight Added, and Prepaid. No additional charges will be allowed for packing, packages, or partial delivery costs.

b. CONTRACT PERIOD: NOVEMBER 28, 2018 through FEBRUARY 20, 2017

c. COMPLIANCE WITH CIVIL RIGHTS LAWS AND EQUAL OPPORTUNITY EMPLOYMENT /
NONDISCRIMINATION

The contractor shall comply with all applicable local, State and Federal statutes and regulations regarding civil rights laws and equal opportunity employment. The Nebraska Fair Employment Practice Act prohibits contractors of the State of Nebraska, and their subcontractors, from discriminating against any employee or applicant for employment, with respect to hire, tenure, terms, conditions or privileges of employment because of race, color, religion, sex, disability, or national origin (Neb. Rev. Stat. §48-1101 to 48-1125). The contractor guarantees compliance with the Nebraska Fair Employment Practice Act, and breach of this provision shall be regarded as a material breach of contract. The contractor shall insert a similar provision in all subcontracts for services to be covered by any contract resulting from this contract.

d. PERMITS, REGULATIONS, LAWS

The contractor shall procure and pay for all permits, licenses, and approvals necessary for the execution of the contract. The contractor shall comply with all applicable local, state, and federal laws, ordinances, rules, orders, and regulations.

e. IMPORTANT NOTICE

Pursuant to Neb. Rev. Stat. § 84-602.02, all State contracts in effect as of January 1, 2014 will be posted to a public website beginning July 1, 2014. All non-proprietary or confidential information as defined by State Law WILL BE POSTED FOR PUBLIC VIEWING.

f. OWNERSHIP OF INFORMATION AND DATA

The State of Nebraska shall have the unlimited right to publish, duplicate, use, and disclose all information and data developed or derived by the contractor pursuant to this contract.

The contractor must guarantee that it has the full legal right to the materials, supplies, equipment, and other rights or titles (e.g. rights to licenses transfer or assign deliverables) necessary to execute this contract. The contract price shall, without exception, include compensation for all royalties and costs arising from patents, trademarks, and copyrights that are in any way involved in the contract. It shall be the responsibility of the contractor to pay for all royalties and costs, and the State must be held harmless from any such claims.

g. INDEPENDENT CONTRACTOR

It is agreed that nothing contained herein is intended or should be construed in any manner as creating or establishing the relationship of partners between the parties hereto. The contractor represents that it has, or will secure at its own expense, all personnel required to perform the services under the contract. The contractor's employees and other persons engaged in work or services required by the contractor under the contract shall have no contractual relationship with the State; they shall not be considered employees of the State.

All claims on behalf of any person arising out of employment or alleged employment (including without limit claims of discrimination against the contractor, its officers, or its agents) shall in no way be the responsibility of the State. The contractor will hold the State harmless from any and all such claims. Such personnel or other persons shall not require nor be entitled to any compensation, rights or benefits from the State including without limit, tenure rights, medical and hospital care, sick and vacation leave, severance pay or retirement benefits.

h. CONTRACTOR RESPONSIBILITY

The contractor is solely responsible for fulfilling the contract, with responsibility for all services offered and products to be delivered as stated in the contract. The contractor shall be the sole point of contact regarding all contractual matters.

If the contractor intends to utilize any subcontractors' services, the subcontractors' level of effort, tasks and time allocation must be clearly defined in the contract. The contractor shall agree that it will not utilize any subcontractors not specifically included in this contract, in the performance of the contract, without the prior written authorization of the State. Following execution of the contract, the contractor shall proceed diligently with all services and shall perform such services with qualified personnel in accordance with the contract.

i. CONTRACTOR PERSONNEL

The contractor warrants that all persons assigned to the project shall be employees of the contractor or specified subcontractors, and shall be fully qualified to perform the work required herein. Personnel employed by the contractor to fulfill the terms of the contract shall remain under the sole direction and control of the contractor. The contractor shall include a similar provision in any contract with any subcontractor selected to perform work on the project.

Personnel commitments made in the contract shall not be changed without the prior written approval of the State. Replacement of key personnel, if approved by the State, shall be with personnel of equal or greater ability and qualifications.

The State reserves the right to require the contractor to reassign or remove from the project any contractor or subcontractor employee.

In respect to its employees, the contractor agrees to be responsible for the following:

- 1) any and all employment taxes and/or other payroll withholding;
- 2) any and all vehicles used by the contractor's employees, including all insurance required by state law;
- 3) damages incurred by contractor's employees within the scope of their duties under the contract;
- 4) maintaining workers' compensation and health insurance and submitting any reports on such insurance to the extent required by governing State law; and
- 5) determining the hours to be worked and the duties to be performed by the contractor's employees.

Notice of cancellation of any required insurance policy must be submitted to the State when issued and a new coverage binder shall be submitted immediately to ensure no break in coverage.

j. STATE OF NEBRASKA PERSONNEL RECRUITMENT PROHIBITION

The contractor shall not, at any time, knowingly recruit or employ any State employee or agent who is working with the contract or in relation to this contract.

k. CONFLICT OF INTEREST

The contractor certifies that there does not now exist any relationship between the contractor and any person or entity which is or gives the appearance of a conflict of interest related to this contract or project.

The contractor certifies that it shall not take any action or acquire any interest, either directly or indirectly, which will conflict in any manner or degree with the performance of its services hereunder or which creates an actual or appearance of conflict of interest.

The contractor certifies that it will not employ any individual known by contractor to have a conflict of interest.

l. ERRORS AND OMISSIONS

The contractor shall not take advantage of any errors and/or omissions in this contract. The contractor must promptly notify the State of any errors and/or omissions that are discovered.

m. ASSIGNMENT BY THE STATE

The State shall have the right to assign or transfer the contract or any of its interests herein to any agency, board, commission, or political subdivision of the State of Nebraska. There shall be no charge to the State for any assignment hereunder.

n. ASSIGNMENT BY THE CONTRACTOR

The contractor may not assign, voluntarily or involuntarily, the contract or any of its rights or obligations hereunder (including without limitation rights and duties of performance) to any third party, without the prior written consent of the State, which will not be unreasonably withheld.

o. GOVERNING LAW

The contract shall be governed in all respects by the laws and statutes of the State of Nebraska. Any legal proceedings against the State of Nebraska regarding this contract shall be brought in the State of Nebraska administrative or judicial forums as defined by State law. The contractor must be in compliance with all Nebraska statutory and regulatory law.

p. ATTORNEY'S FEES

In the event of any litigation, appeal or other legal action to enforce any provision of the contract, the contractor agrees to pay all expenses of such action, as permitted by law, including attorney's fees and costs, if the State is the prevailing party.

q. ADVERTISING

The contractor agrees not to refer to the contract in advertising in such a manner as to state or imply that the company or its services are endorsed or preferred by the State. News releases pertaining to the project shall not be issued without prior written approval from the State.

r. EARLY TERMINATION

The contract may be terminated as follows:

- 1) The State and the contractor, by mutual written agreement, may terminate the contract at any time.
- 2) The State, in its sole discretion, may terminate the contract for any reason upon 30 days written notice to the contractor. Such termination shall not relieve the contractor of warranty or other service obligations incurred under the terms of the contract. In the event of cancellation the contractor shall be entitled to payment, determined on a pro rata basis, for products or services satisfactorily performed or provided.
- 3) The State may terminate the contract immediately for any of the following reasons:
 - 1) if directed to do so by statute;
 - 2) contractor has made an assignment for the benefit of creditors, has admitted in writing its inability to pay debts as they mature, or has ceased operating in the normal course of business;
 - 3) a trustee or receiver of the contractor or of any substantial part of the contractor's assets has been appointed by a court;
 - 4) fraud, misappropriation, embezzlement, malfeasance, misfeasance, or illegal conduct pertaining to performance under the contract by its contractor, its employees, officers, directors or shareholders;
 - 5) an involuntary proceeding has been commenced by any party against the contractor under any one of the chapters of Title 11 of the United States Code and (i) the proceeding has been pending for at least sixty (60) days; or (ii) the contractor has consented, either expressly or by operation of law, to the entry of an order for relief; or (iii) the contractor has been decreed or adjudged a debtor;
 - 6) a voluntary petition has been filed by the contractor under any of the chapters of Title 11 of the United States Code;
 - 7) contractor intentionally discloses confidential information;

- 8) contractor has or announces it will discontinue support of the deliverable;
- 9) second or subsequent documented "vendor performance report" form deemed acceptable by the State Purchasing Bureau.

s. FUNDING OUT CLAUSE OR LOSS OF APPROPRIATIONS

The State may terminate the contract, in whole or in part, in the event funding is no longer available. The State's obligation to pay amounts due for fiscal years following the current fiscal year is contingent upon legislative appropriation of funds for the contract. Should said funds not be appropriated, the State may terminate the contract with respect to those payments for the fiscal years for which such funds are not appropriated. The State will give the contractor written notice thirty (30) days prior to the effective date of any termination, and advise the contractor of the location (address and room number) of any related equipment. All obligations of the State to make payments after the termination date will cease and all interest of the State in any related equipment will terminate. The contractor shall be entitled to receive just and equitable compensation for any authorized work which has been satisfactorily completed as of the termination date. In no event shall the contractor be paid for a loss of anticipated profit.

t. BREACH BY CONTRACTOR

The State may terminate the contract, in whole or in part, if the contractor fails to perform its obligations under the contract in a timely and proper manner. The State may, by providing a written notice of default to the contractor, allow the contractor to cure a failure or breach of contract within a period of thirty (30) days (or longer at State's discretion considering the gravity and nature of the default). Said notice shall be delivered by Certified Mail, Return Receipt Requested or in person with proof of delivery. Allowing the contractor time to cure a failure or breach of contract does not waive the State's right to immediately terminate the contract for the same or different contract breach which may occur at a different time. In case of default of the contractor, the State may contract the service/goods from other sources and hold the contractor responsible for any excess cost occasioned thereby.

u. ASSURANCES BEFORE BREACH

If any document or deliverable required pursuant to the contract does not fulfill the requirements of the contract, upon written notice from the State, the contractor shall deliver assurances in the form of additional contractor resources at no additional cost to the project in order to complete the deliverable, and to ensure that other project schedules will not be adversely affected.

v. PROHIBITION AGAINST ADVANCE PAYMENT

Payments shall not be made until contractual deliverable(s) are received and accepted by the State.

w. PAYMENT

State will render payment to contractor when the terms and conditions of the contract and specifications have been satisfactorily completed on the part of the contractor as solely determined by the State. Payment will be made by the responsible agency in compliance with the State of Nebraska Prompt Payment Act (See Neb. Rev. Stat. §81-2401 through 81-2408). The State may require the contractor to accept payment by electronic means such as ACH deposit. In no event shall the State be responsible or liable to pay for any services/goods provided by the contractor prior to receipt, and the contractor hereby waives any claim or cause of action for any such services/goods.

x. INVOICES

Invoices for payments must be submitted by the contractor to the agency requesting the services/goods with sufficient detail to support payment. The terms and conditions included in the contractor's invoice shall be deemed to be solely for the convenience of the parties. No terms or conditions of any such invoice shall be binding upon the State, and no action by the State, including without limitation the payment of any such invoice in whole or in part, shall be construed as binding or estopping the State with respect to any such term or condition, unless the invoice term or condition has been previously agreed to by the State as an amendment to the contract.

y. TAXES

Purchases of goods or services made by the State of Nebraska are exempt from the payment of Federal Excise Taxes, and exemption certificates will be furnished on request. State and local taxes are exempt by State Statute Section 77-2704 (l) (m). Exemption by statute precludes the furnishing of State exemption certificates.

z. INSPECTION AND APPROVAL

Final inspection and approval of all work required and/or goods received under the contract shall be performed by the designated State officials. The State and/or its authorized representatives shall have the right to enter any

premises where the contractor or subcontractor duties under the contract are being performed, and to inspect, monitor or otherwise evaluate the work being performed. All inspections and evaluations shall be at reasonable times and in a manner that will not unreasonably delay work.

aa. SEVERABILITY

If any term or condition of the contract is declared by a court of competent jurisdiction to be illegal or in conflict with any law, the validity of the remaining terms and conditions shall not be affected, and the rights and obligations of the parties shall be construed and enforced as if the contract did not contain the particular provision held to be invalid.

bb. CONFIDENTIALITY

All materials and information provided by the State or acquired by the contractor on behalf of the State shall be regarded as confidential information. All materials and information provided by the State or acquired by the contractor on behalf of the State shall be handled in accordance with Federal and State Law, and ethical standards. The contractor must ensure the confidentiality of such materials or information. Should said confidentiality be breached by a contractor; contractor shall notify the State immediately of said breach and take immediate corrective action.

It is incumbent upon the contractor to inform its officers and employees of the penalties for improper disclosure imposed by the Privacy Act of 1974, 5 U.S.C. 552a. Specifically, 5 U.S.C. 552a (i)(1), which is made applicable to contractors by 5 U.S.C. 552a (m)(1), provides that any officer or employee of a contractor, who by virtue of his/her employment or official position has possession of or access to agency records which contain individually identifiable information, the disclosure of which is prohibited by the Privacy Act or regulations established thereunder, and who knowing that disclosure of the specific material is prohibited, willfully discloses the material in any manner to any person or agency not entitled to receive it, shall be guilty of a misdemeanor and fined not more than \$5,000.

cc. LIMITATION OF LIABILITY

It is understood by the parties that in the State of Nebraska's opinion, any limitation on the contractor's liability is unconstitutional under the Nebraska State Constitution, Article XIII, Section 3, and that any limitation of liability shall not be binding on the State of Nebraska despite inclusion of such language in documents supplied with the contractor's bid or in the final contract.

dd. INDEMNIFICATION

1) GENERAL

The contractor agrees to defend, indemnify, hold, and save harmless the State and its employees, volunteers, agents, and its elected and appointed officials ("the indemnified parties") from and against any and all claims, liens, demands, damages, liability, actions, causes of action, losses, judgments, costs, and expenses of every nature, including investigation costs and expenses, settlement costs, and attorney fees and expenses ("the claims"), sustained or asserted against the State, arising out of, resulting from, or attributable to the willful misconduct, negligence, error, or omission of the contractor, its employees, subcontractors, consultants, representatives, and agents, except to the extent such contractor liability is attenuated by any action of the State which directly and proximately contributed to the claims.

2) INTELLECTUAL PROPERTY

The contractor agrees it will at its sole cost and expense, defend, indemnify, and hold harmless the indemnified parties from and against any and all claims, to the extent such claims arise out of, result from, or are attributable to the actual or alleged infringement or misappropriation of any patent, copyright, trade secret, trademark, or confidential information of any third party by the contractor or its employees, subcontractors, consultants, representatives, and agents; provided, however, the State gives the contractor prompt notice in writing of the claim. The contractor may not settle any infringement claim that will affect the State's use of the Licensed Software without the State's prior written consent, which consent may be withheld for any reason.

If a judgment or settlement is obtained or reasonably anticipated against the State's use of any intellectual property for which the contractor has indemnified the State, the contractor shall at the contractor's sole cost and expense promptly modify the item or items which were determined to be infringing, acquire a license or licenses on the State's behalf to provide the necessary rights to the State to eliminate the infringement, or provide the State with a non-infringing substitute that provides the State the same functionality. At the State's election, the actual or anticipated judgment may be treated as a breach of warranty by the contractor, and the State may receive the remedies provided under this contract.

3) PERSONNEL

The contractor shall, at its expense, indemnify and hold harmless the indemnified parties from and against any claim with respect to withholding taxes, worker's compensation, employee benefits, or any other claim, demand, liability, damage, or loss of any nature relating to any of the personnel provided by the contractor.

ee. ANTITRUST

The contractor hereby assigns to the State any and all claims for overcharges as to goods and/or services provided in connection with this contract resulting from antitrust violations which arise under antitrust laws of the United States and the antitrust laws of the State.

ff. TIME IS OF THE ESSENCE

Time is of the essence in this contract. The acceptance of late performance with or without objection or reservation by the State shall not waive any rights of the State nor constitute a waiver of the requirement of timely performance of any obligations on the part of the contractor remaining to be performed.

gg. DRUG POLICY

Contractor certifies it maintains a drug free work place environment to ensure worker safety and workplace integrity. Contractor agrees to provide a copy of its drug free workplace policy at any time upon request by the State.

hh. EMPLOYEE WORK ELIGIBILITY STATUS

The Contractor is required and hereby agrees to use a federal immigration verification system to determine the work eligibility status of employees physically performing services within the State of Nebraska. A federal immigration verification system means the electronic verification of the work authorization program authorized by the Illegal Immigration Reform and Immigrant Responsibility Act of 1996, 8 U.S.C. 1324a, known as the E-Verify Program, or an equivalent federal program designated by the United States Department of Homeland Security or other federal agency authorized to verify the work eligibility status of a newly hired employee.

If the Contractor is an individual or sole proprietorship, the following applies:

- 1) The Contractor must complete the United States Citizenship Attestation Form, available on the Department of Administrative Services website at www.das.state.ne.us.
- 2) If the Contractor indicates on such attestation form that he or she is a qualified alien, the Contractor agrees to provide the US Citizenship and Immigration Services documentation required to verify the Contractor's lawful presence in the United States using the Systematic Alien Verification for Entitlements (SAVE) Program.
- 3) The Contractor understands and agrees that lawful presence in the United States is required and the Contractor may be disqualified or the contract terminated if such lawful presence cannot be verified as required by Neb. Rev. Stat. §4-108.

ii. CERTIFICATION REGARDING DEBARMENT, SUSPENSION AND INELIGIBILITY

The contractor certifies that the contractor is not presently debarred, suspended, proposed for debarment, declared ineligible, or voluntarily excluded by any federal department or agency from participating in transactions (debarred). The contractor also agrees to include the above requirements in any and all subcontracts into which it enters. The contractor shall immediately notify the Department if, during the term of this contract, contractor becomes debarred. The Department may immediately terminate this contract by providing contractor written notice if contractor becomes debarred during the term of this contract.

jj. POLITICAL SUB-DIVISIONS

Contractor may extend the Contract to political subdivisions conditioned upon the honoring of the prices charged to the State. Terms and conditions of the Contract must be met by political subdivisions. Under no circumstances shall the State be contractually obligated or liable for any purchases by political subdivisions or other public entities not authorized by Neb. Rev. Stat. § 81-145, listed as "all officers of the state, departments, bureaus, boards, commissions, councils, and institutions receiving legislative appropriations." A listing of Nebraska political subdivisions may be found at the website of the Nebraska Auditor of Public Accounts.

kk. **REPORTS**

The Contractor shall also provide to the State of Nebraska primary contact person quarterly utilization reports containing at a minimum the following information pertaining to State of Nebraska agencies, boards, commissions, and political subdivisions utilization:

- 1) Ordering Entity
- 2) Purchase order number;
- 3) Description;
- 4) Quantity; and
- 5) Price.

These reports will be provided in Excel format and sent via email on a quarterly basis as follows:

<u>Period End</u>	<u>Report Due</u>
December 31	January 31
March 31	April 30
June 30	July 31
September 30	October 31

Reports shall be sent to: as.materieipurchasing@nebraska.gov; to the attention of the Participating Entity's primary contact. Please include the contract number, 14684 OC, in the subject line of the email.

- ll. **ADMINISTRATIVE FEE /REBATE** The Contractor agrees to provide a quarterly administrative fee in the form of a check. The fee will be payable to the State for an amount equal to one-half percent (.05%) the net sales (net of any returns, credits, or adjustments under this Addendum for the period. The Contractor's NJPA pricing to the State shall not be adjusted to offset for the equivalent fee amount. Payments shall be made in accordance with following schedule:

<u>Period End</u>	<u>Fee Due</u>
December 31	January 31
March 31	April 30
June 30	July 31
September 30	October 31

The Contractor agrees to provide a quarterly utilization report, reflecting new sales to the State during the associated fee period. The report shall be in the format developed by the Lead State and as agreed to by the Contractor. The report will be provided in secure electronic format and/or submitted electronically to the State contact listed in the Addendum

- mm. **ADMINISTRATIVE FEE/REBATE REMITTANCE LOCATION**
All Administrative Fees/Rebates will be sent to the following address:

State Purchasing Bureau
c/o Central Finance, Administrative Services
1526 K Street, Suite 240
Lincoln, NE 68508

- nn. **WARRANTY**
The Contractor will provide a copy of the manufacturer's warranty to the State of Nebraska upon signature of the participating addendum.

3. **Primary Contacts:** The primary contact individuals for this participating addendum are as follows (Or their named successors):

Contractor: Falcon Road Maintenance Equipment LLC

Name	Ric Simon
Address	120 Waldo Ave Midland MI 48642
Telephone	248-207-1783
Fax	

National Joint Powers Alliance® (NJPA) Contract #113012-FRM
State of Nebraska Contract: 14684 OC

(Or their named successors):

Contractor: Falcon Road Maintenance Equipment LLC

Name	Ric Simon
Address	120 Waldo Ave Midland MI 48642
Telephone	248-207-1783
Fax	
E-mail	ric@falconrme.com

Participating Entity: State of Nebraska

Name	State of Nebraska Rita Schwabe
Address	1526 K Street, Suite 130 Lincoln, NE 68508
Telephone	402-471-4194
Fax	402-471-2089
E-mail	rita.schwabe@nebraska.gov

IN WITNESS WHEREOF, the parties have executed this Addendum as of the date of execution by both parties below.

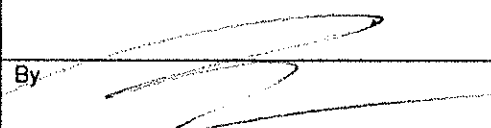
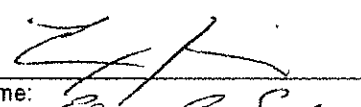
Participating State: State of Nebraska	Contractor: Falcon Road Maintenance Equipment, LLC
By: 	By: 
Name: Bo Botelho	Name: ERIC R. SMOL
Title: DAS Materiel Administrator	Title: VICE PRESIDENT
Date: 12/9/16	Date: 11/28/2016

IT'S A HOT BOX
IT'S A RECYCLER
IT'S A FALCON

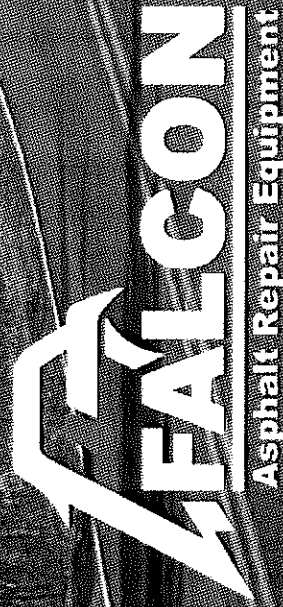

IT'S A FALCON

A Falcon makes fixing potholes, repairing utility cuts and patching asphalt easy -- very easy.

When used as a **hot box**, it keeps asphalt hot all day and holds it overnight to eliminate waste that occurs when asphalt hardens in the back of an unheated truck bed.

When used as a **recycler**, it provides year-round access to hot mix asphalt.

Falcon's patented heat management system:

- Is third-party certified to operate at 92% fuel efficiency using less than three gallons of diesel fuel per 8-hour shift.
- Provides even hopper temperatures to help eliminate material scorching from hot spots and material hardening from cold spots.
- Prevents asphalt from cooling during transport by allowing the burner to run while being towed.

Hopper capacities range from 1/2 ton to 10 tons with trailer, dump box, truck-mount, hook-lift and MINI models available with over 100 bolt-on options.

VERSATILE, SAFE, EFFICIENT, DURABLE... IT'S A FALCON!

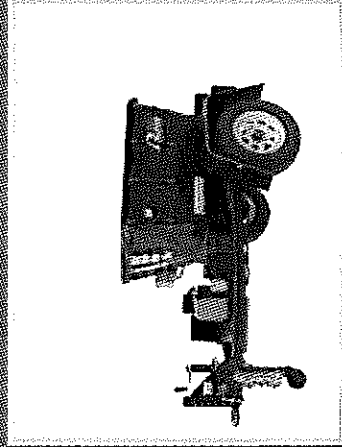
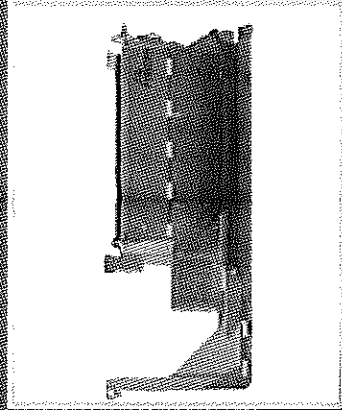
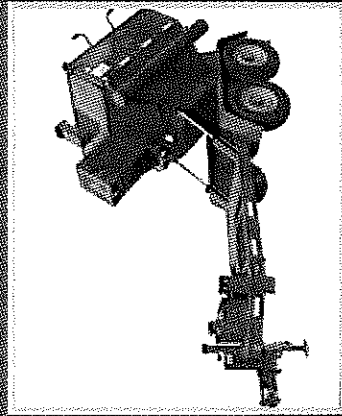

IT'S A HOT BOX

- Transport asphalt and keep it hot all day.
- Hold hot mix overnight.
- Heat and re-heat cold patch.

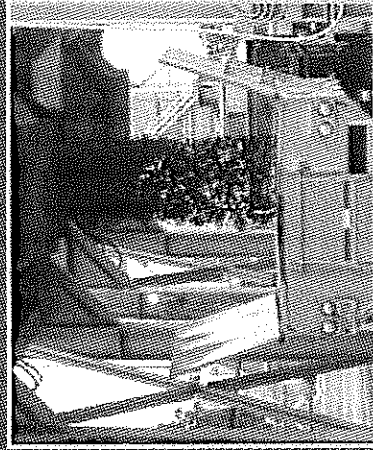

IT'S A RECYCLER

- Recycle leftover asphalt.
- Recycle asphalt chunks torn up from the pavement.
- Recycle asphalt millings.



IT'S A FALCON

- Patented heat management system:
 - One-piece, seamless, ceramic combustion chamber rated for 2,300° F.
 - Combustion chamber shape and construction creates a tumbling action that forces a complete blending of fuel, air and heat to achieve high combustion (fuel) efficiency.
 - Independently certified to have 92% fuel efficiency - uses less than 3 gallons of diesel fuel per 8-hour shift.
 - Even hopper temperatures to eliminate:
 - Material scorching from hot spots.
 - Material hardening from cold spots.
 - To prevent material from cooling while being transported, a Falcon is engineered to allow the burner to run while in tow.

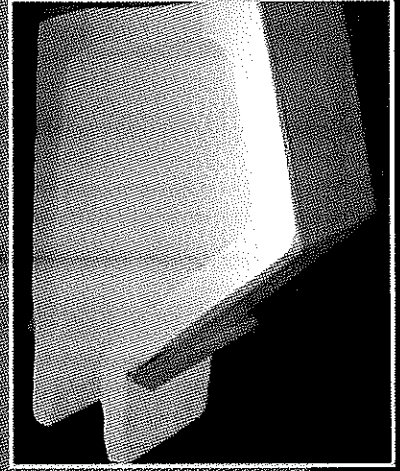

TRAILER MODEL

AVAILABLE IN 2, 3 & 4 TON

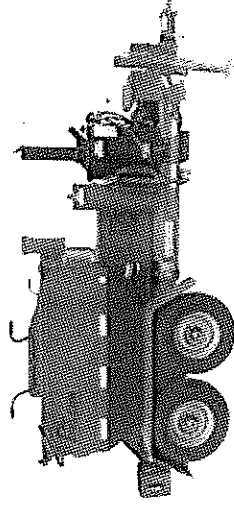
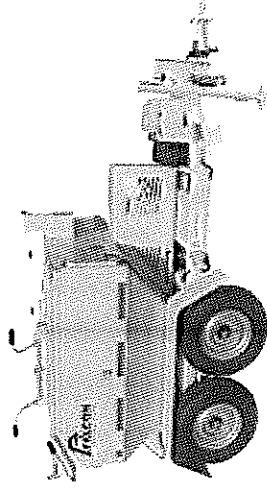
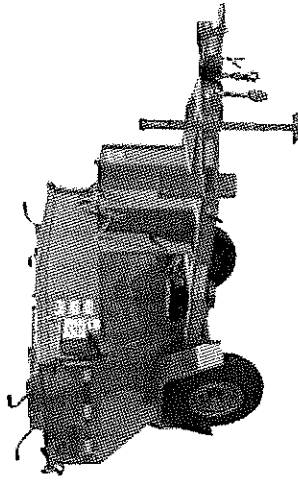

IT'S VERSATILE

- Recycle leftover asphalt, chunks and millings.
- Transport asphalt and keep it hot all day.
- Hold hot mix overnight.
- Heat and re-heat cold patch.

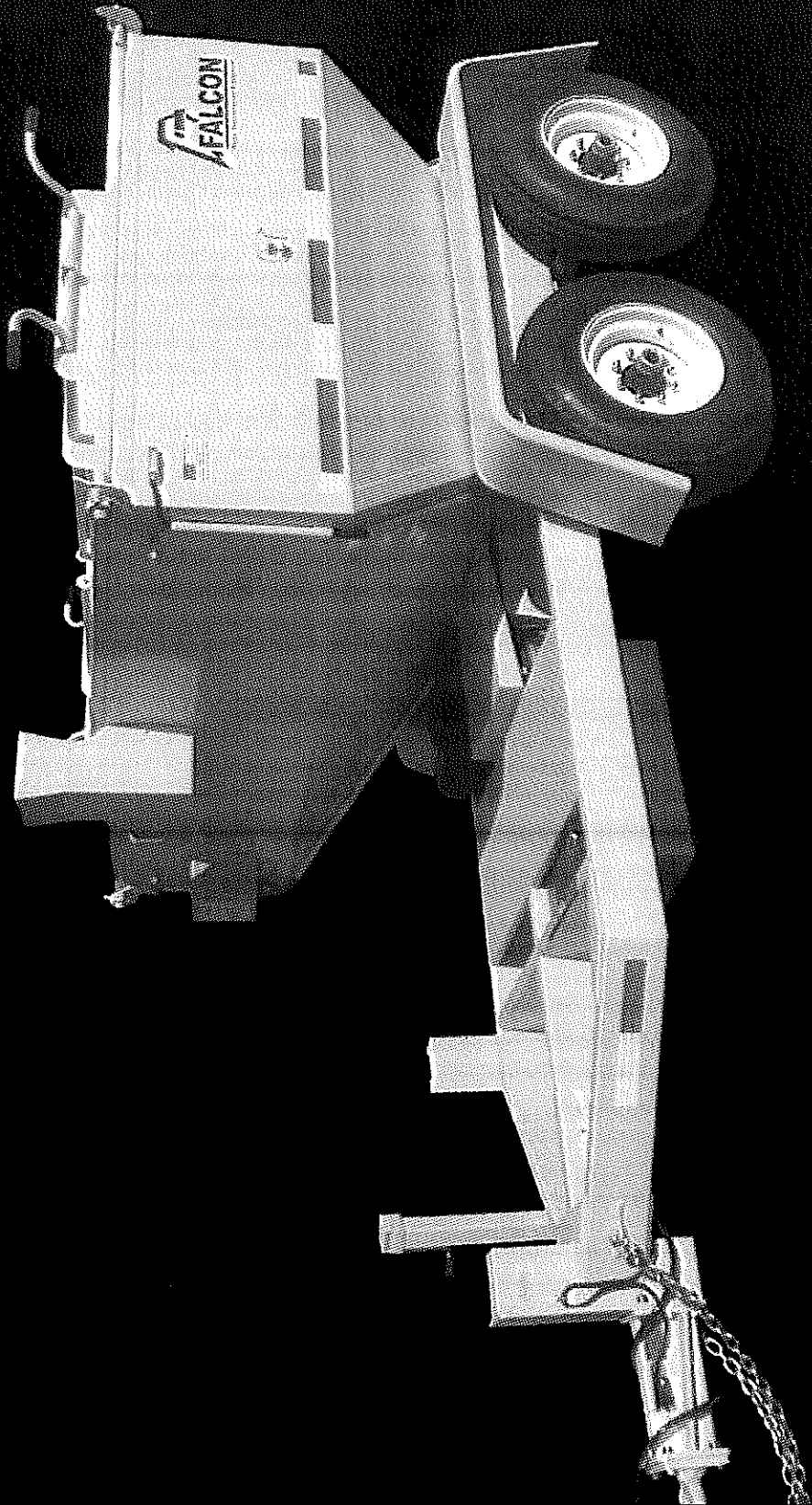

DUMP BOX MODEL

AVAILABLE IN 2, 3, 4 & 6 TON

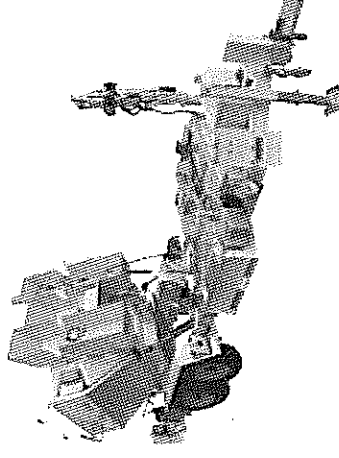
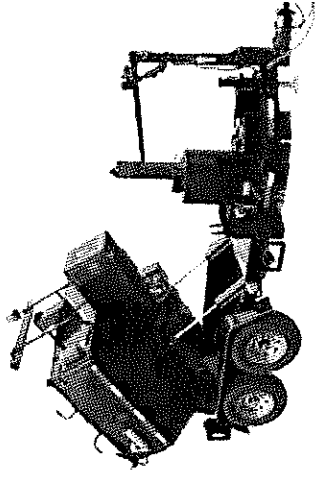
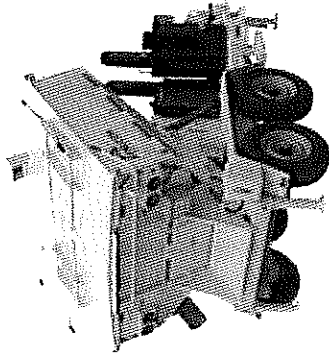

IT'S SAFE

- Rear unloading door handle is located on the curbside...
 - Allows operator to stand out of traffic when using door
 - Keeps operator away from hot asphalt when dump box is raised
- Dump box trailers are constructed with...
 - Two hydraulic cylinders that raise the hopper...
 - Each cylinder acts as a safety backup for the other
 - Dual cylinder design prevents the hopper from twisting if the load is uneven
 - Tandem axle frame to ensure stability when hopper is raised
- Hopper has triple wall construction with high-temperature insulation to keep outer hopper walls safe to the touch

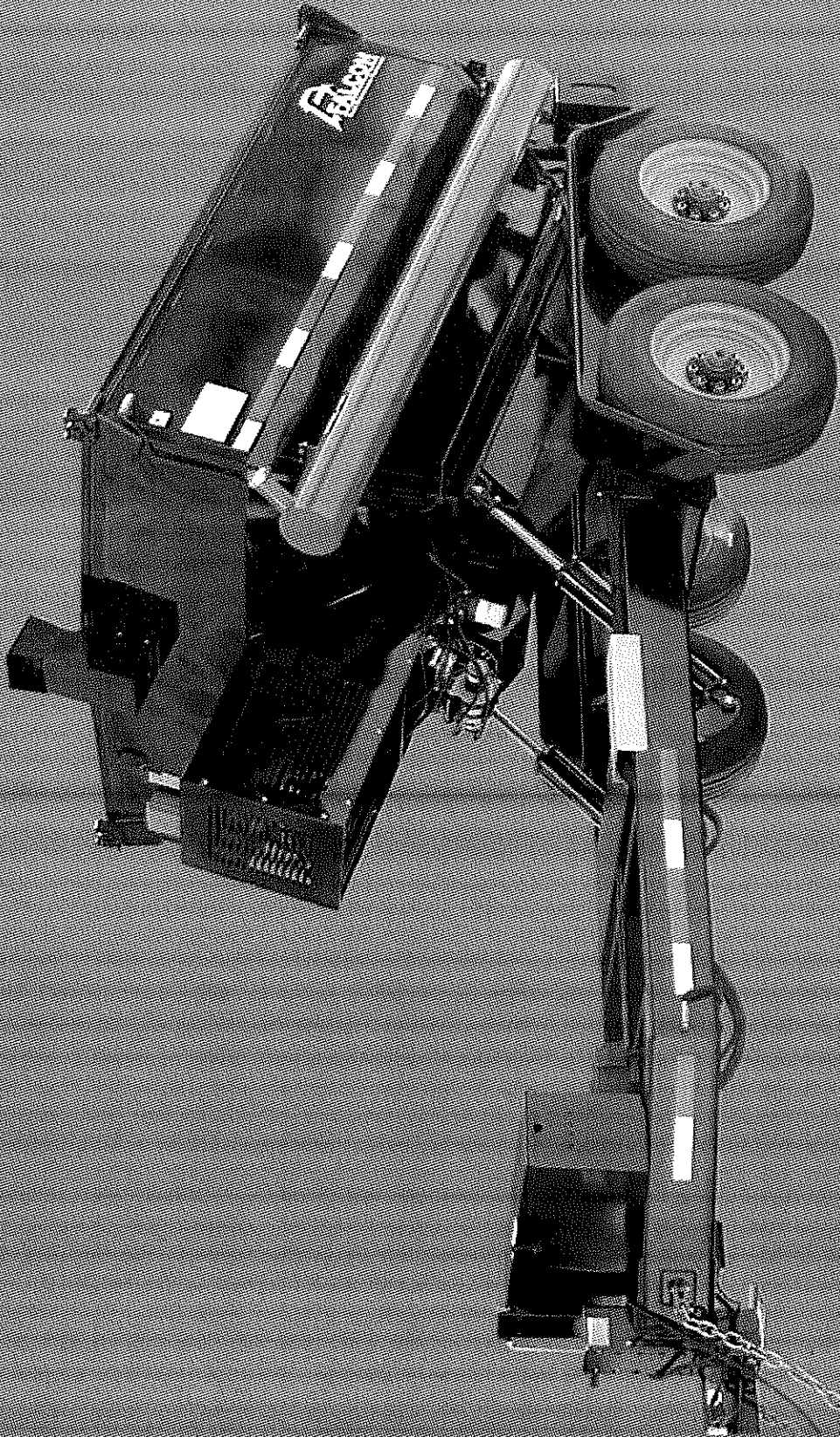

TRUCK-MOUNT MODEL

AVAILABLE IN 2, 3, 4, 5, 6, 8 & 10 TON

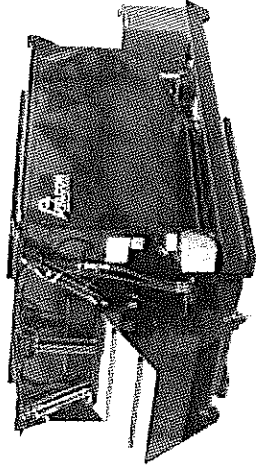
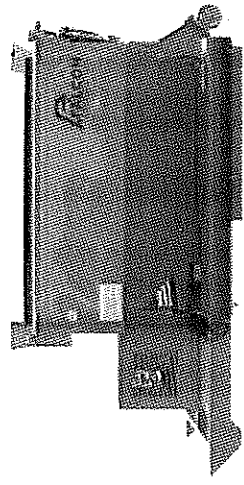
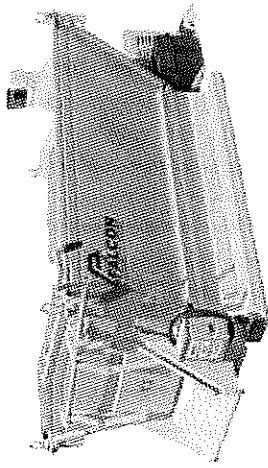

IT'S EFFICIENT

- Combustion chamber shape and construction creates a tumbling action that forces a complete blending of fuel, air and heat to achieve high combustion (fuel) efficiency.
- Independently certified to have 92% fuel efficiency...
 - Uses less than 3 gallons of diesel fuel per 8-hour shift.
 - Extremely low carbon and NOX emissions resulting from high combustion efficiency.
- High combustion efficiency helps eliminate dirty cold cell condition caused by un-combusted fuel.
- Triple wall construction with high-temperature insulation — once heat gets in the hopper, it stays in the hopper.

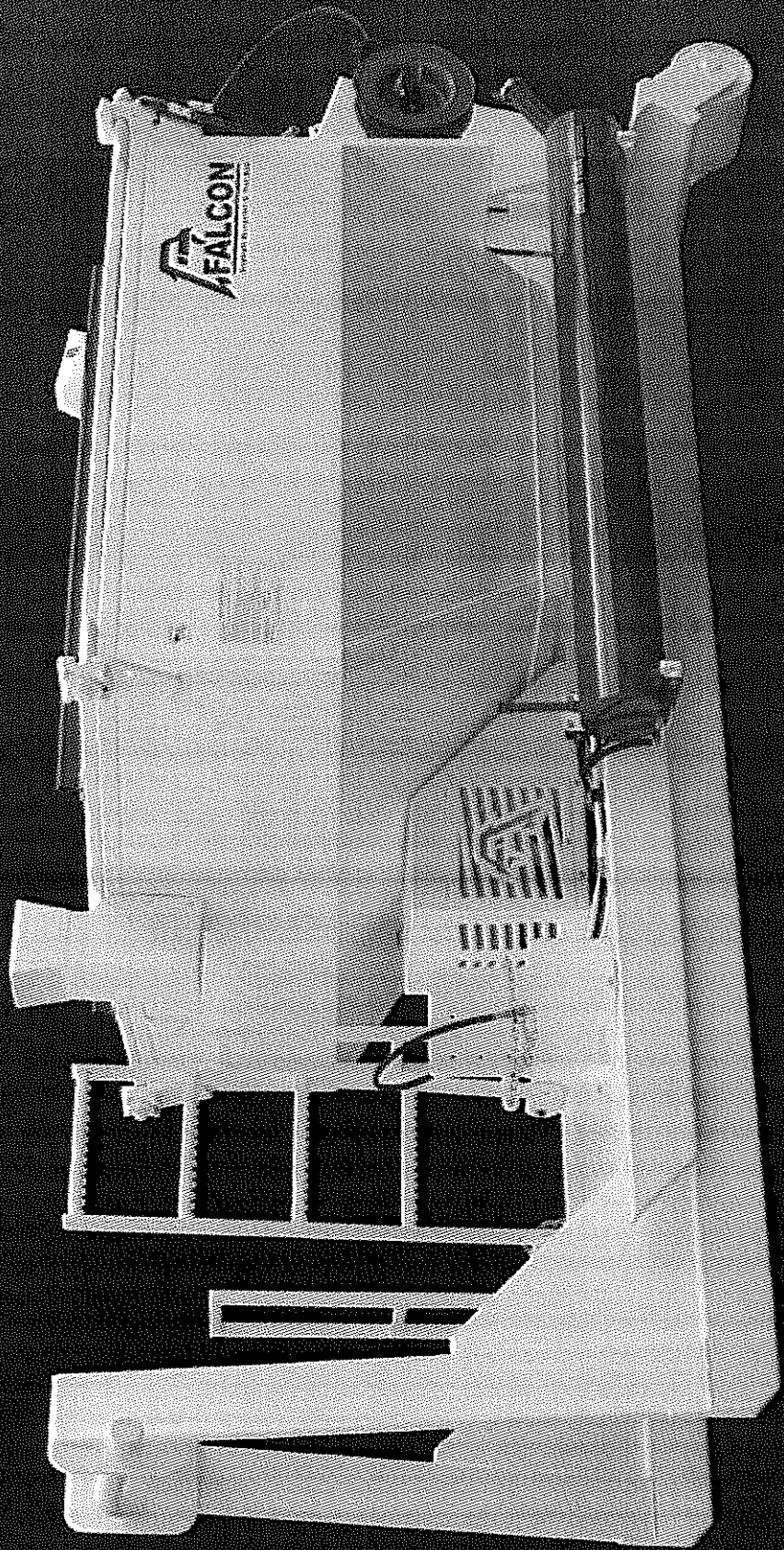

MINI MODEL

AVAILABLE IN 1/2 & 1 TON

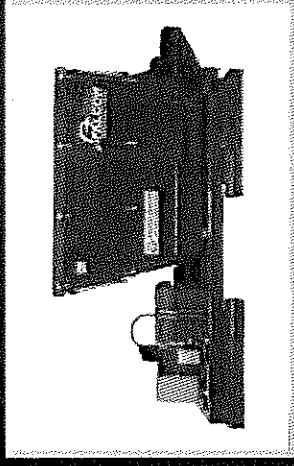

IT'S DURABLE

- Trailers are constructed of structural rectangular steel tubing – all welds on frame are continuous with boxed-in and enclosed gussets.
- To ensure even distribution of heat, hopper walls have engineered steel baffles to meter the flow of heat.
- Hopper walls are one-piece, seamless steel construction. To add structural integrity and prevent the hopper from becoming out of square, the hopper walls have 10-gauge steel capping channel on the top and 10-gauge steel corner molding on the sides.
- One-piece, seamless, ceramic combustion chamber is rated for 2,300°F. Seamless combustion chamber design extends useful life of equipment.
- Wiring connections are soldered, sealed, placed in shrink-tubing then covered with high-temperature loom and protected by steel conduit. All wiring is NEMA-3 rated and external to the hopper to prevent damage from heat. Junction box includes circuit breakers to protect the tow-vehicle from the 12-volt trailer wiring and the 12-volt trailer wiring from the tow-vehicle.
- Entire machine is sandblasted then painted with an epoxy primer and urethane finish coat. All accessory bolt-on parts are sandblasted, primed and painted prior to assembly.

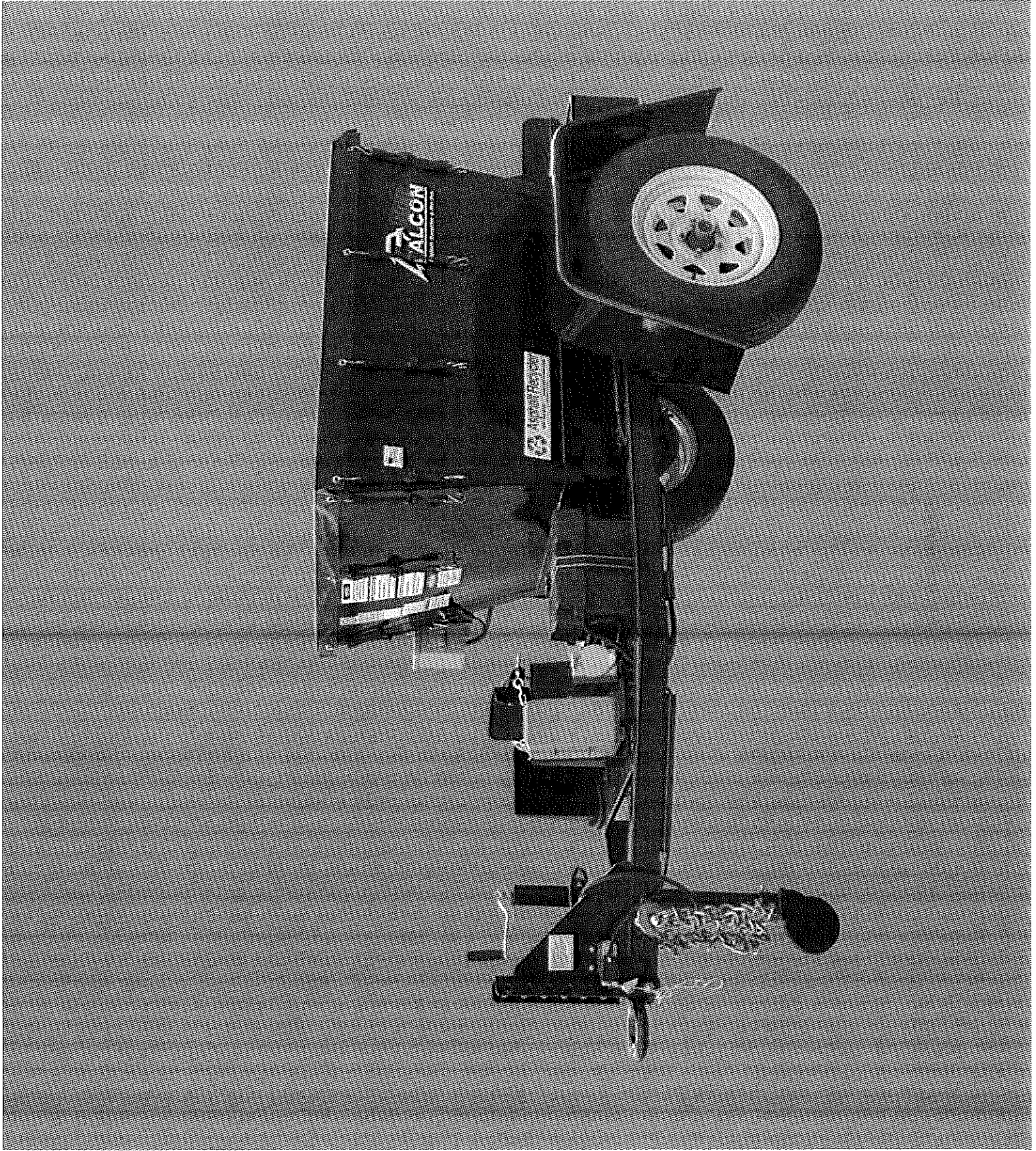

STANDARD TECHNICAL SPECIFICATIONS

Patented Heat Management System

- Diesel or propane fuel source
- One-piece, seamless, ceramic combustion chamber rated for 2,300° F
- Combustion chamber designed to create a tumbling action that forces a complete blending of fuel, air and heat to achieve high fuel efficiency
- Certified 92% fuel efficiency — uses less than 3 gallons of diesel fuel per 8-hour shift
- Automatic temperature control
- 12-volt deep cycle marine grade battery
- Average annual diesel burner maintenance cost of \$150

Hopper

- Trailer hopper capacities of 2, 3 & 4 tons
- Dump box hopper capacities of 2, 3, 4 & 6 tons
- Truck-mount hopper capacities of 2, 3, 4, 5, 6, 8 & 10 tons
- MINI hopper capacities of 1/2 & 1 ton
- Triple wall construction
- All four walls are one-piece, seamless steel construction
- 10-gauge capping channel and corner molding add structural integrity to the hopper to prevent it from becoming out of square and to extend equipment's useful life
- Hopper floor is 1/4" steel
- Floor and all four walls are heated and insulated
- Burner-box is located below hopper floor
- Area beyond the back hopper wall is a heated worktable
- Hopper floor is free from any steel wall or divider obstruction

Top Loading Doors

- Fully insulated
- Hinged at the hopper corners with bolt-on, greasable pillow block bearings
- Hydraulic top loading doors standard on 3, 4, 5, 6, 8 & 10 ton truck-mount and 6 ton dump box
- MINI model utilizes hopper tarp cover

Rear Unloading Door

- Handle is located on curbside of hopper to place operator out of traffic when using door
- For ease of opening, door is equipped with replaceable CAM follower bearings
- Hydraulic rear unloading door standard on 3, 4, 5, 6, 8 & 10 ton truck-mount and 6-ton dump box
- MINI model utilizes a removable rear unloading door

Wiring

- Wiring connections are soldered, sealed, placed in shrink-tubing then covered with high-temperature corrugated loom and protected by steel conduit
- Junction box with circuit breakers protects tow-vehicle from trailer and trailer from tow-vehicle
- All wiring external to hopper to prevent heat damage
- All wiring and enclosures are NEMA-3 rated

Frame

- Electric brakes with safety breakaway (surge brakes optional)
- Single axle (1/2, 1 & 2 ton) or tandem axle (2, 3, 4 & 6 ton)
- Trailer frame constructed of structural rectangular steel tubing with boxed-in and enclosed gussets
- All welds on frame are continuous
- Pintle eye hitch is adjustable from 18" to 32" (tandem axle)

Dump Box

- Tilts hopper by means of two hydraulic cylinders
- Each cylinder acts as a safety backup to the other
- Trailer frame and hopper have 45° angled steel guides that center the lowered hopper to minimize cylinder wear

Paint

- Sandblasted then painted with two coats of epoxy primer and urethane finish
- All accessory bolt-on parts are sandblasted, primed and painted prior to assembly
- Standard colors include red, yellow, orange and black

FMCSA and NATM compliant

RECYCLING!

Our patented technology uses indirect, radiant heat to break down leftover asphalt, chunks and millings.

Hardened asphalt is mixed with rejuvenator by coating it during the hopper loading process. It is then heated overnight at the lowest possible temperature to retain the original oil content and to give the rejuvenator time to absorb into the asphalt.

Protecting original oils is the key to returning asphalt to its original state.

Earlier recycling methods shot a direct open flame onto hardened asphalt. This method burns off the original oils making the asphalt dry. Black oily smoke produced by these older recycling methods is evidence of oil loss.

By using indirect, radiant heat, Falcon solved the problem of oil loss caused by recycling with a direct open flame.

WHY SHOULD YOU RECYCLE?

- Don't waste leftover asphalt, chunks and millings — recycle them.
- Make permanent hot mix repairs year-round — eliminate temporary cold patch repairs.
- Save time traveling to the asphalt plant and waiting in line.
- Have on-site access to affordable hot mix asphalt year-round.

WHY CAN A FALCON RECYCLE?

We protect the original oils

- Protecting the original oils is the key to returning asphalt to its original state.
- Falcon protects the original oils by using indirect, radiant heat to break down the hardened asphalt at the lowest possible temperature.

We use heat very efficiently

- Combustion chamber shape and construction yields 92% fuel efficiency to make recycling affordable.
- High-density insulation retains hopper heat required to break down asphalt.
- Upper burner and cross ducts distribute heat through the center of the hopper.

We build equipment that takes “the heat and the hit”

- Heat management system components are built to withstand temperatures required for recycling asphalt.
- Hopper is built to withstand drops of large chunks of hardened asphalt from a front loader.

WHY RECYCLE OVERNIGHT?

- Protect the original oils — Time is available to slowly heat the hardened asphalt at the lowest possible temperature.
- Save time and money — Asphalt is ready at the beginning of the work shift leaving the entire day for making repairs.
- It's simple — Hardened asphalt is mixed with rejuvenator by coating it during the hopper loading process.

WHAT CAN A FALCON RECYCLE?

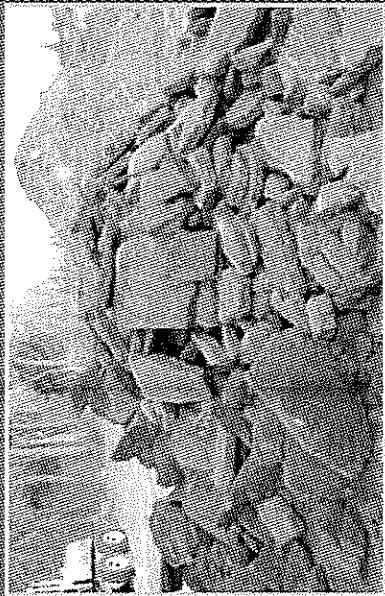

ASPHALT CHUNKS

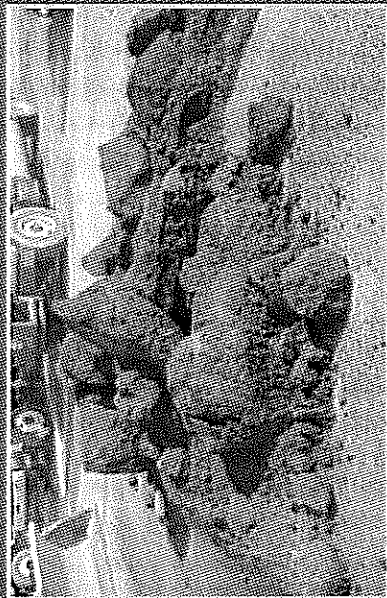

LEFTOVER ASPHALT

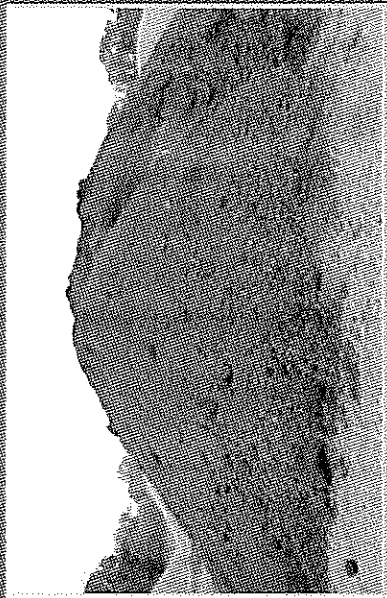

ASPHALT MILLINGS

ASPHALT RECYCLING PROCESS

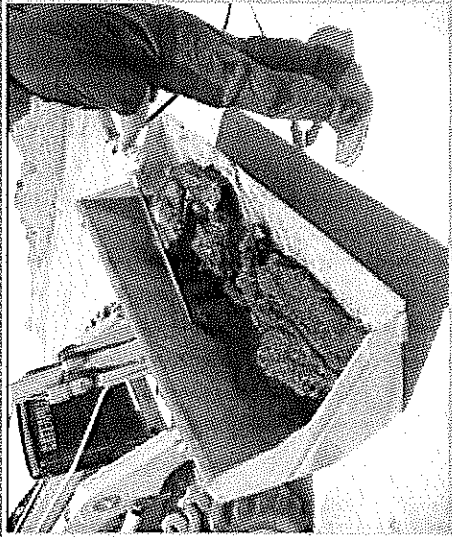

COAT ASPHALT WITH REJUVENATOR

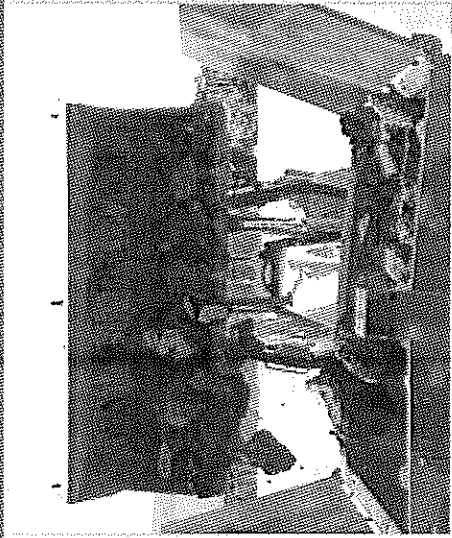

LOAD HOPPER

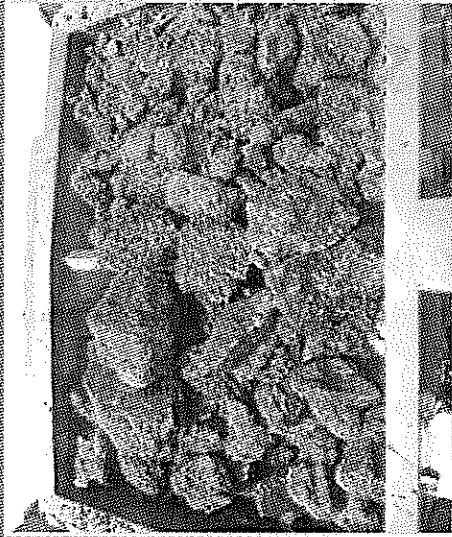

RECYCLE ASPHALT OVERNIGHT

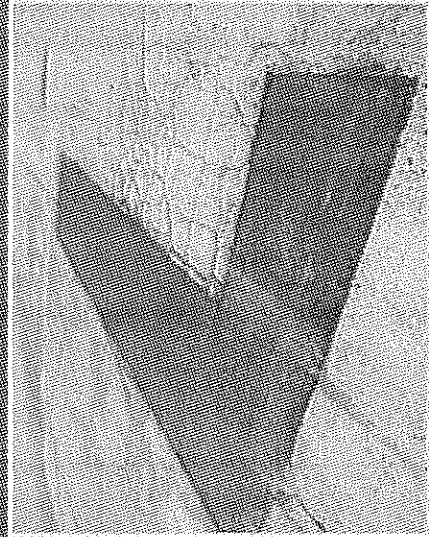
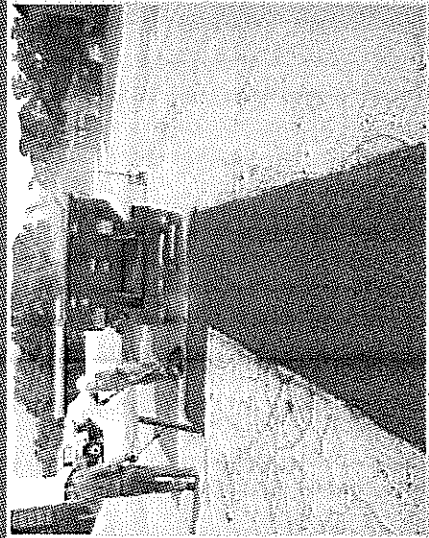
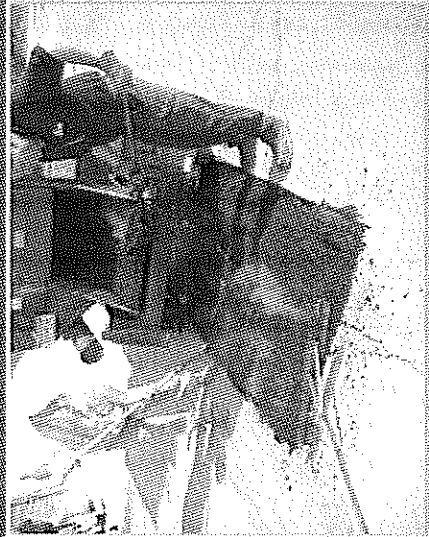

BUILD YOUR BIRD

Trailer Model

- Dump Box for Trailer Units
(12-volt electric over hydraulic; tandem axle)
- Extended Frame
(2 or 4 foot extension)
- Hydraulic Unloading and Loading Doors
(12-volt electric over hydraulic)

Fuel Source

- Diesel Burner / Auto Temp Control / 12-Volt Battery
- Propane Burner / Auto Temp Control / 12-Volt Battery (propane tanks not included)
- Cold Weather Package
(DAVCO diesel fuel preheater)
- Diesel Burner Tune-Up Kit

Asphalt Recycling Options

- Dual Burner Recycling Package
(2nd burner, 2nd heat duct and 24-hour timer included)
- Spray System for Heated Rejuvenator or Tack
(for spraying water-based rejuvenator or tack only)
- Hose Reel (for spray system)
- Battery Charger Package
- Timer - 24-Hour
- Timer - 7-Day

Truck-Mount Model

- Upgrade Hydraulic Loading Doors to Bi-Fold
(recommended for all truck-mount units with hydraulic doors)
- Hook Lift Sub-Frame

Warning Light Options

- Arrow Board (LED or non-LED)
- Arrow Stick (LED or non-LED)
- Backup Lights
- LED Lighting Upgrade
(two red LED 4" round stop/tail/turn lights per side)
- LED Lighting Upgrade
(one red LED 4" round stop/tail/turn light and one amber strobe per side)
- LED Lighting Upgrade
(two red LED 4" round stop/tail/turn lights and one amber strobe per side)
- Night Work Lights (LED or non-LED)
- Warning Light / STROBE

Asphalt Rejuvenator and Release Agent

- Rejuvenating Liquid for Asphalt Recycling
(5-gallon pail or 55-gallon drum)
- Asphalt Release Agent
(5-gallon pail or 55-gallon drum)
- Asphalt Release Agent Dispenser Holder for Solvent Sprayer (sprayer not included)

Rejuvenator / Emulsion Tack Tank Options

- 15 or 30 Gallon Non-Heated/Non-Insulated Gravity Feed
- 15 or 30 Gallon Non-Heated/Insulated Gravity Feed
- 15 or 30 Gallon Heated/Insulated Gravity Feed (dedicated burner)
- Oil-Jacketed Heated Tack Tank Upgrade (for petroleum-based liquid material only)
- Spray System for Heated Tack (for spraying water-based tack only)
- Hose Reel (for spray system)
- Pour Pot with Mounting Bracket

Compaction Equipment & Mounting Options

- Bomag Plate Compactor
14" x 22" plate - w/o water (BVP10/36-2)
or w/ water (BVP10/36-2W)
- 18" x 22" plate - w/o water (BVP18/45-2)
or w/ water (BVP18/45-2W)
- Bomag Plate Compactor Wheels
- VIBCO Vibratory Roller (GR-1600) - 8" x 12" Drum
- VIBCO Vibratory Roller (GR-3200) - 18" x 24" Drum
- Basket for Mounting Plate Compactor or Roller (ID 24" x 24")
- Hoist with Manual Winch
- Hoist with 12-Volt Winch
- Infrared Transporter (includes hoist with 12-volt winch)

Other Equipment & Options

- 16" Tire Upgrade
- Backup Alarm
- Battery Charger Package
- Drinking Water Cooler
- Emergency Stop Button
- Extended Trailer Hitch (2 or 3 feet total)
- Fire Extinguisher (5 or 10 pound) with Mounting Bracket
- Front and Rear Hopper Extensions
- Hand-Held Torch with Bracket for 20 lb. Cylinder (propane tank not included)
- Propane Torch Hose Reel
- Hour Meter (for primary burner)
- Matching Spare Tire On Wheel
- Spare Tire Mounting Bracket
- Hopper Access Step
- 50/550 Analog Thermometer
- Timer - 24-Hour
- Timer - 7-Day
- Tool Holder - 2, 3, 4 or 5-Positions
- Toolbox - 10" W x 10" H x 25" L
- Warning Triangles
- Water Tank (15-gallons)
- Wheel Chocks with Mounting Bracket

Asphalt Volume Calculator

- 1 Ton: 6' x 6' x 4" Depth
- 2 Ton: 9' x 9' x 4" Depth
- 3 Ton: 11' x 11' x 4" Depth
- 4 Ton: 12' x 13' x 4" Depth
- 5 Ton 14' x 14' x 4" Depth
- 6 Ton 15' x 16' x 4" Depth
- 8 Ton 18' x 18' x 4" Depth
- 10 Ton 20' x 20' x 4" Depth

**IT'S A HOT BOX
IT'S A RECYCLER
IT'S A FALCON**

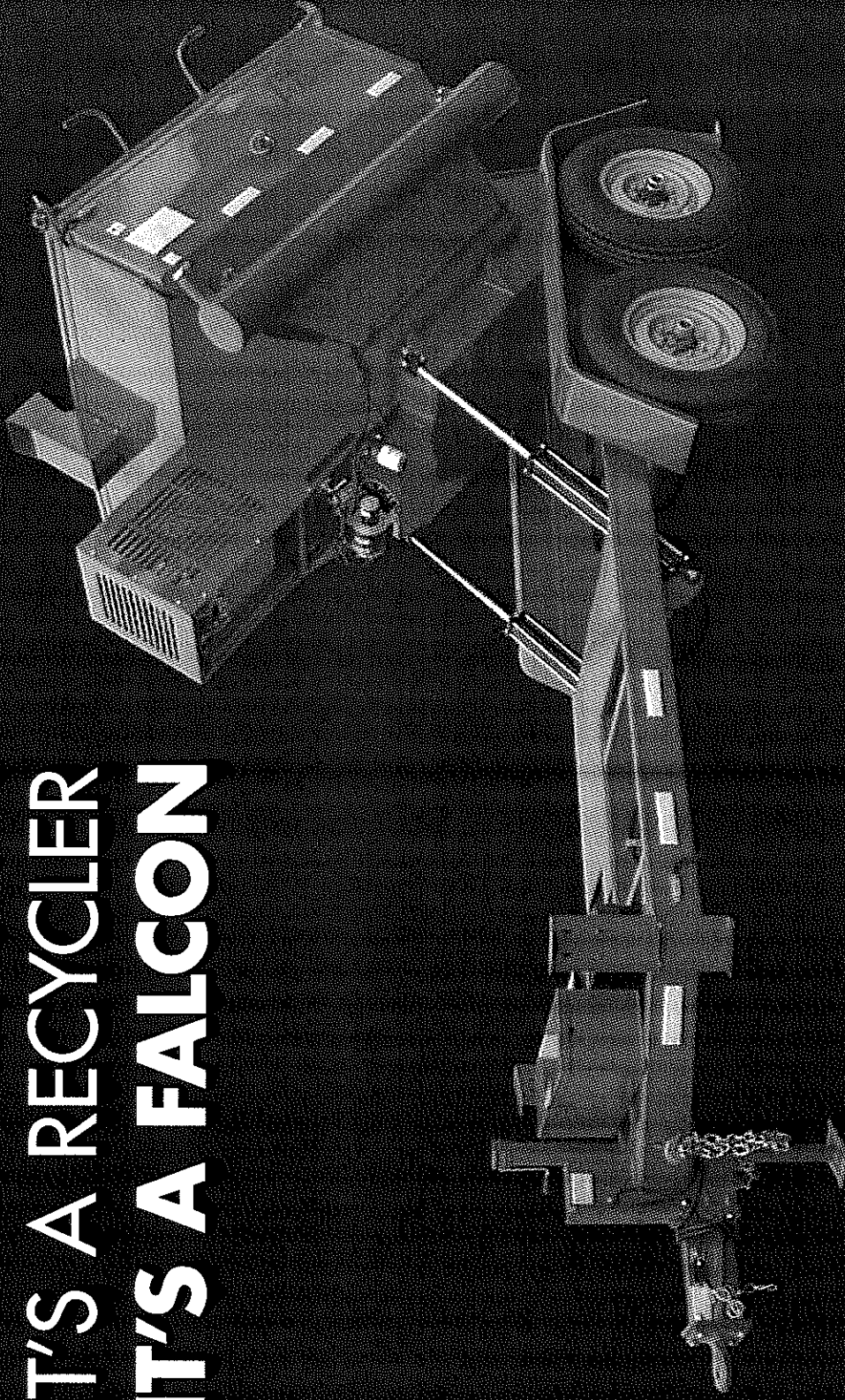

FALCON
Asphalt Recycler & Hot Box

U.S. Patent No. 8,465,225

Available on Competitively Bid NJPA National Contract - #113012-FRM

Falcon Road Maintenance Equipment, Inc. - Midland, MI - (989) 495-9332 - www.falconrme.com

NJPA
National Joint Powers Alliance®